

Past Congresses

1897	Zurich	1962	Stockholm
1900	Paris	1966	Moscow
1904	Heidelberg	1970	Nice
1908	Rome	1974	Vancouver
1912	Cambridge, UK	1978	Helsinki
1920	Strasbourg	1982	Warsaw (held in 1983)
1924	Toronto	1986	Berkeley
1928	Bologna	1990	Kyoto
1932	Zurich	1994	Zurich
1936	Oslo	1998	Berlin
1950	Cambridge, USA	2002	Beijing
1954	Amsterdam	2006	Madrid
1958	Edinburgh		



Organisation of the Congress

M. S. Raghunathan, President of the ICM 2010

The National Board for Higher Mathematics (NBHM) is an organisation constituted by the Government of India to oversee the development of mathematics in the country. The initiative to make a bid to hold the International Congress of Mathematicians (ICM) 2010 came from NBHM. A Provisional Organising Committee (POC) was formed and a subcommittee – the Bid Committee was given the job of preparing the Bid Document. Delhi was proposed as the venue.

The bid document gave background information on the current state of mathematics and its organisation in the country. There was also a brief write-up about the city of Delhi and India as a tourist destination. Letters of support for holding the Congress received from institutions from all over the country were part of the documentation. The Department of Atomic Energy of the Government of India pledged (informally) support to the tune of 40 million rupees (approximately \$800,000 at the then exchange rate). This informal letter was also part of the bid-document. A copy of a letter from the Prime Minister of India, Dr Manmohan Singh addressed to the President (John Ball) of IMU welcoming the holding of the ICM in India, was one of the important components of the bid-document.



A 3-member site-inspection team (consisting of John Ball, Ma Zhi Ming and Ragni Piene) constituted by the IMU EC visited Delhi and were given the details of the organisational plans by the POC. However during some deliberations of the POC held after this visit, it was brought to the attention of the committee that an excellent convention centre had recently opened in the city of Hyderabad which, with its state-of-the-art facilities, would be ideally suited for holding the Congress. The POC visited Hyderabad in late 2004 to examine the feasibility of holding the ICM there instead of in Delhi. The Hyderabad International Convention Centre (HICC) was indeed found to be an excellent place for holding the Congress. However there was some concern about the availability of other infra-structural facilities in the city of Hyderabad such as adequate number of hotel rooms of good quality. The Committee however was

reassured by local people consulted on this issue that the requisite facilities were available. The city of Hyderabad was reasonably well connected with Europe as well as America.

It was therefore decided to revise the bid making Hyderabad, rather than Delhi, the venue. The POC informed the IMU EC of their intention to modify the bid making Hyderabad the venue. John Ball visited Hyderabad on behalf of the IMU EC, inspected the available facilities and told the Indian POC to go ahead with the proposed modification of the bid. The POC also fixed 19 - 27 August 2010 as the dates for the ICM (with August 23 as the “off” day). The POC also devised a logo for ICM 2010. The logo represents the standard fundamental domain with the famous Ramanujan Conjecture written out along the rim of the unit circle.

The Indian bid was formally presented at the 2006 IMU General Assembly held at Santiago de Compostela (in Spain) by the Indian Delegation (which consisted of S. G. Dani, R. Hans-Gill, S. Kesavan and G. Misra). The IMU EC recommended acceptance of the Indian bid (there was only one other bid – from Canada) to the General Assembly which endorsed the EC’s recommendation.

With the acceptance of the bid, the POC was renamed (Local) Organising Committee (OC). The OC was a rather large body and for ensuring efficient functioning, a more compact body the “Executive Organising Committee” was formed. Its members were: M. S. Raghunathan (Chair) and S. G. Dani (Vice Chair) (both of Tata Institute of Fundamental Research, Mumbai), Rajat Tandon (Secretary), T. Amaranath (Treasurer) and S. Kumaresan (all of the University of Hyderabad), Gadadhar Misra and G. Rangarajan (both of Indian Institute of Science, Bangalore), S. Kesavan (Institute of Mathematical Sciences, Chennai), Rahul Roy (Indian Statistical Institute, Delhi), R. N. Puri (India Convention Promotion Bureau, Delhi) and Joint Secretary (R&D), DAE. At a later point the committee was expanded to include R. Balasubramanian (Institute of Mathematical Sciences, Chennai), V. Rao Aiyagiri (Department of Science and Technology) and Dinesh Singh (University of Delhi).

The EOC’s first action was to take steps to ensure adequate funding for the ICM and related activities. Towards this end, the Chair wrote to the Department of Science and Technology of the Government of India requesting that the department make a provision of the order of 20 million rupees for supporting travel, registration and subsistence of about 1000 Indian participants and for the conduct of some 20 satellite meetings which were expected to be proposed. The EOC also submitted a formal detailed project proposal to the DAE titled “International Congress of Mathematicians 2010” seeking 60 million rupees as a grant for the project. The proposal to the DAE suggested that the organisation of the ICM would be undertaken as a project by the University of Hyderabad. S. E. Hasnain, Vice Chancellor of the University wrote to the DAE that the university would be willing to undertake the project with the EOC overseeing its implementation. DAE accepted the proposal and formally agreed to provide the 60 million rupees asked for to the University of Hyderabad for implementing the project.

In response to the request for support, the DST wanted a formal project proposal with a much wider scope for the promotion of mathematics, incorporating the specific requests for support of activities connected with the ICM. Such a proposal was drafted by S. Kesavan and M. Krishna of the Institute of Mathematical Sciences, Chennai (IMSc) and submitted to the DST. In the meanwhile the EOC made an announcement inviting applications from Indian mathematicians who wanted to participate in the ICM and needed support. To ensure a fair geographic distribution of the delegates to be supported, the EOC divided the country into five regions and formed a committee for each region to scrutinise applications and select candidates for support. The recommendations of the committees were to be passed on to S. Kesavan and M. Krishna who would instruct IMSc to reimburse the selected candidates out of the funds to be provided by DST.

The EOC formed also a committee chaired by M. S. Narasimhan to which those desirous of organising satellite meetings could apply for funds. Once again the recommendations of this committee would be passed on to IMSc. S. Kesavan was the Secretary-Convenor of the committee.

The next important step taken by EOC was to make firm the hiring of the Hyderabad International Convention Centre for the Congress. This was done after protracted negotiations conducted largely by Rajat Tandon (Secretary EOC). A contract was entered into with HICC with a payment schedule drawn up and clear commitments on the part of HICC concerning the facilities to be provided.

It was decided at an early meeting of the EOC to hire the services of a professional conference organiser (PCO). The PCO was to be entrusted the responsibility for (on-line) registration of delegates, accommodation and transport arrangements for the delegates during the Congress, arrangements for tours and travels, assistance with the organisation of cultural programmes and the opening and closing functions. They were also to act as liaison between the EOC and HICC. The EOC called for tenders from the various Conference Organisers in the country. A committee chaired by S. Reghunathan, Retired Chief Secretary, Delhi scrutinised the applications and after several meetings and interviews with representatives of some short-listed companies chose K. W. Conferences for the organisation of the ICM.

A website (www.icm2010.org.in) was created in January 2007. The website furnished information about India in general and more detailed information on the city of Hyderabad. It also started a page called Mathematical Miscellany which carried miscellaneous information relating to mathematics, especially things connected with India. In May 2009 a site for pre-registration was created by the PCO (K. W. Conferences) and a link provided to this site from the ICM-2010 website. In January 2010 a site for on-line registration was also created and the Registration Fee was fixed at 16,000 rupees for working mathematicians, 8,000 rupees for graduate students, and 3,000 rupees for accompanying persons provided the fees were paid by April 15. This date was later extended to June 15. Higher rates were charged for those who registered after this date. The website also provided information on securing visas to India. In March 2010, K.

W. Conferences set up webpages for hotel reservations and also for registration for tours.



In March 2009 H. W. Lenstra, the Chair of the Programme Committee appointed by the IMU EC, provided the EOC with the list of invited plenary and sectional speakers as well as the participants in various panels. Invitations were sent out to all the invitees by M. S. Raghunathan (Chair EOC) in April 2009. All invited sectional speakers were offered free registration and were requested to submit abstracts and texts of their talks by March 15, 2010. The plenary speakers and panelists were requested to submit abstracts by that date and manuscripts by May 15, 2010. About ten invitees declined and were replaced by other names by the Programme Committee.

The IMU EC also added two more lectures to the programme: the Abel Lecture sponsored by the Norwegian Academy to be given by S. R. S. Varadhan, the 2006 Abel Laureate, and the Noether Lecture to be given by Idun Reiten and these were included in the programme.

The organisation “European Women in Mathematics” approached the EOC asking for support to organise a 2-day meeting focussing on contributions of women to mathematics to be held just ahead of the ICM in Hyderabad. The EOC responded favourably to the request and formed a Local Organising Committee chaired by Shobha Madan of IIT Kanpur for the purpose. The EOC also extended financial support of 2 million rupees for organising the meeting which was given the name International Congress of Women Mathematicians 2010. It was scheduled for August 16-18, 2010 at the University of Hyderabad.

The EOC formed several subcommittees which were assigned specific tasks. Each of the subcommittees was chaired by a member of the EOC with the exception of the Editorial Committee for the Proceedings of the ICM, which was chaired by Rajendra Bhatia of ISI Delhi. These committees were to liaise with the PCO and supervise the PCO’s work. The Chair of each subcommittee was given the primary responsibility for the committee’s work. S. Kumaresan was to oversee registration of delegates and the accommodation arrangements for participants supported by the EOC. T Amaranath (Treasurer) supervised transport arrangements. Rajat Tandon (Secretary) was charged with the responsibility of arranging cultural programmes. S. Kesavan was in charge of scheduling of lectures and other events. M. S. Raghunathan had the responsibility of securing funds. Gadadhar Misra was to handle all matters relating to the General Assembly (held at Bengaluru during 16-17 August) with the assistance of G. Rangarajan. R Balasubramanian was to liaise with the Department

of Science and Technology, while Dinesh Singh and Rahul Roy were to liaise with other government departments in Delhi and the President's Secretariat.

Apart from the funding obtained from the Indian government, the IMU provided funds of the order of 5 million rupees. In addition the IMU also funded the travel of about 100 delegates from developing countries. Further support was obtained from private sources in India. Shri R. Thyagarajan of Chennai made a generous donation of 6 million rupees while Shri N. R. Narayana Murthy of Infosys gave 2 million rupees. Infosys also made available 300 rooms in their excellent guest-house in Hyderabad free of cost for the delegates to the Congress. Microsoft India was also among the donors.

The EOC approached the Honourable President of India Shrimathi Pratibha Devisingh Patil with the request that she inaugurate the ICM on August 19, 2010 and give away the prizes. The President accepted the EOC's invitation and the inaugural function was held at 11 AM on August 19, 2010.

The President was received on her arrival at the venue by S. E. Hasnain, László Lovász (President, IMU) and M. S. Raghunathan and led to the dais by them. Seated on the dais were the two other special guests, the Governor and the Chief Minister of Andhra Pradesh, Martin Grötschel (Secretary, IMU), László Lovász, M. S. Raghunathan, S. E. Hasnain, Louis Nirenberg (the recipient of the Chern Prize) and Rajat Tandon.

The proceedings began with the playing of the national anthem. Raghunathan welcomed the President, other dignitaries and the delegates to the Congress. Lovász then addressed the gathering as the President of the IMU. This was followed by the President giving away the prizes: Grötschel announced the composition of the prize committees followed by the names of the prize winners and the citations. The prize winner then went up to the President and received the medal from her. After that the prize winner received the prize cheque from a representative of the sponsor. Altogether seven prizes were given away: four Fields Medals, Nevanlinna Prize, Gauss Prize and Chern Prize. The President then addressed the gathering. She spoke of India's long engagement with mathematics and its active role in international cooperation. She offered congratulations to the prize winners and welcomed the delegates wishing them a pleasant and fruitful stay in India. The Chief Minister also extended his welcome to the delegates. Rajat Tandon proposed the vote of thanks. The function ended with the playing of the national anthem again. The programme was compered by Chandna Chakraborty.

After the President left the inaugural function continued. Lovász and Grötschel briefed the delegates about the various initiatives connected with the ICMs taken by the EC since the previous Congress in Spain in 2006. The passing away of V. Arnold and H. Cartan, who were both involved with IMU activities in the past, and of K. Itô was condoled. Raghunathan was named President of ICM 2010 by Lovász. The meeting ended with a brief reply by Raghunathan.

In the afternoon there were laudations of the Fields Medallists: H. Furstenberg was the laudator for E. Lindenstrauss, J. Arthur for Ngô Bao Châu, H. Kesten for S. Smirnov and H. T. Yau for C. Villani. This was followed by the lau-

dation for the Nevanlinna Prize winner D. Spielman by G. Kalai. The academic programme for the day ended with the Abel Lecture by S. R. S. Varadhan. K. R. Parthasarathy was in the chair. In the evening the EOC hosted a dinner in honour of the prize-winners and invited speakers.

On the second day, in the morning there were special sessions (9 AM to 12:30 PM) devoted to the Gauss and Chern Prizes. There was a talk on the work of Yves Meyer, the Gauss Prize winner, by Ingrid Daubechies. The session on the Chern Prize – which was being given for the first time – was more elaborate. There was a talk about Chern’s work and a video film on him was also shown. May Chu, Chern’s daughter spoke about her father. Yan Yan Li spoke on the work of Louis Nirenberg, the Chern Prize winner.

In the evening, there was an Indian classical dance programme by Nrityashree a dance troupe led by a renowned Bharata Natyam dancer, Professor C. V. Chandrasekhar. The dance-drama titled *Panchamahabhutham* was a depiction through dance of the functioning of the five *bhutas* – *bhumi* (earth), *jalam* (water), *akasha* (sky), *vayu* (air) and *agni* (fire). Later in the evening, the EOC hosted a dinner for all delegates and accompanying persons. The venue of the dinner was the Shilpa Kala Vedika.

From the third day on, each day, there were four plenary lectures during 9 AM to 2:45 PM with a break for lunch. The 1:45 PM - 2:45 PM slot was reserved for lectures by the Fields Medallists and the Nevanlinna Prize winner. As many as 8 parallel sessions were held for the sectional talks; there were also at the same time parallel sessions for the contributed papers. Two poster sessions were held on 21 August and about 115 posters were displayed. A total of 167 sectional talks of 45-minute duration were held during 3:00 PM to 6:30 PM. There were 19 plenary talks and 7 special lectures. Plenary talks and sectional talks were chaired by distinguished mathematicians, mostly from India. There were several panel discussions, all of which were held during the late afternoons

The EOC organised a chess event on 24 August. Viswanathan Anand, the world chess champion played simultaneous chess against 40 delegates. Except for a solitary draw by a 14-year old, Anand won all the other games. All players received a box of chess men and the board on which they had played, autographed by Anand. Other spectators could also collect Anand’s autographs after the event.

Another cultural event organised by the EOC was the performance of the play “A Disappearing Number” by the well known theatre company, Complicite of London. The play was performed at the Global Peace Auditorium on two days, 21 and 22 August. The play was also open to the general public of Hyderabad.

On 25 August, there was a Classical Hindustani music concert by Ustad Rashid Khan, one of India’s great exponents. EOC organised two lectures on music appreciation by Sunil Mukhi on 22 and 24 August, for the benefit of delegates who may be unfamiliar with Indian music.

In June 2010 the EOC instituted a one-time international prize called the “Leelavati Prize” (of the value 1 million rupees) for public outreach work for mathematics. Nominations for the prize were sought from mathematical societies around the world, as also from mathematics departments of many

universities and research institutions. The Prize committee chaired by M. S. Narasimhan awarded the prize to Simon Singh, citing among other things, the book as well as the documentary film he had produced on Fermat's Last Theorem. Singh gave a public lecture on the making of the documentary on August 25.

Idun Reiten gave the Emmy Noether Lecture in the morning of the 27th. Claire Voisin chaired this lecture.

The Closing Ceremony was held on August 27 in the afternoon. It was conducted by Dinesh Singh. At this ceremony, on behalf of the International Commission on History of Mathematics, Kim Plofker handed over the 2009 Kenneth O'May Prize for History of Mathematics to R. C. Gupta. Lovász handed over the Leelavati Prize to Simon Singh. Lovász also announced that Ingrid Daubechies will take over from him as President of the IMU from January 2011. It was also announced that a stable office for the IMU was being set up in Berlin. It was announced that the Republic of Korea would host the 2014 Congress at Seoul. The Korean delegation was congratulated by those on the dais and the Korean delegation extended a warm welcome to all present to ICM 2014. The Closing Ceremony ended with a vote of thanks by Rajat Tandon.

Several embassies held receptions during the Congress. The U. S. National Committee, the London Mathematical Society, and the Indo-French Institute for Mathematics also hosted receptions. These were mainly in honour of the prize winners and invited speakers. People involved in the organisation of the ICM were among the invitees.

About 3000 delegates attended the Congress of which roughly 1500 were from India. Of these about 1000 received support from the Department of Science and Technology of the Government of India. IMU funded the travel of some 100 delegates from developing countries whose local hospitality was taken care of by the EOC. In addition the EOC funded the travel as well as local hospitality for another 50 delegates from countries neighbouring India and offered local hospitality to about 150 delegates from outside India.

The EOC and IMU EC cooperated closely in the organisation of the ICM at Hyderabad. For the Indian mathematical community hosting the Congress was a great experience.

Committees

I. Local Organizing Committees

- **National Advisory Committee**

M. S. Narasimhan, Tata Institute of Fundamental Research, Bangalore,
Chair

M. S. Raghunathan, Tata Institute of Fundamental Research, Mumbai,
Secretary

Seyed E. Hasnain, University of Hyderabad

Anil Kakodkar, Atomic Energy Commission, Government of India

T. Ramasami, Department of Science and Technology, New Delhi

P. Rama Rao, International Advanced Research Centre for Powder Met-
allurgy and New Materials, Hyderabad.

C. S. Seshadri, Chennai Mathematical Institute, Chennai.

- **Executive Organizing Committee**

M. S. Raghunathan, Tata Institute of Fundamental Research, Mumbai,
Chair

R. Tandon, University of Hyderabad, Hyderabad, *Secretary*

T. Amaranath, University of Hyderabad, Hyderabad, *Treasurer*

R. Balasubramanian, Institute of Mathematical Sciences, Chennai

S. G. Dani, Tata Institute of Fundamental Research, Mumbai

S. Kesavan, Institute of Mathematical Sciences, Chennai

S. Kumaresan, University of Hyderabad, Hyderabad

G. Misra, Indian Institute of Science., Bangalore

R. M. Puri, India Convention Promotion Bureau, New Delhi

G. Rangarajan, Indian Institute of Science, Bangalore

Rahul Roy, Indian Statistical Institute, New Delhi

Dinesh Singh, University of Delhi, New Delhi



Executive Organising Committee

- **Finance Committee**

M. S. Raghunathan, Tata Institute of Fundamental Research, Mumbai,
Chair

T. Amaranath, University of Hyderabad, Hyderabad

S. G. Dani, Tata Institute of Fundamental Research, Mumbai

R. Tandon, University of Hyderabad, Hyderabad

A. K. Kulkarni, Member-Secretary, National Board for Higher Mathematics,

Finance Officer, University of Hyderabad, Hyderabad

- **PCO Liaison Committee**

R. Tandon, University of Hyderabad, Hyderabad, *Chair*

T. Amaranath, University of Hyderabad, Hyderabad

S. Kumaresan, University of Hyderabad, Hyderabad

G. Misra, Indian Institute of Science, Bangalore

G. Rangarajan, Indian Institute of Science, Bangalore

Rahul Roy, Indian Statistical Institute, New Delhi

- **Website Management Committee**

G. Misra, Indian Institute of Science, Bangalore, *Chair*

Pablo Arés Gastesi, Tata Institute of Fundamental Research, Mumbai

Madhavan Mukund, Chennai Mathematical Institute, Chennai

G. Rangarajan, Indian Institute of Science, Bangalore
K. Vishnu Namboothiri, University of Hyderabad, Hyderabad

- **Programme Committee**

S. Kesavan, Institute of Mathematical Sciences, Chennai, *Chair*
T. Amaranath, University of Hyderabad, Hyderabad
Rajendra Bhatia, Indian Statistical Institute, New Delhi
G. Rangarajan, Indian Institute of Science, Bangalore
R. Tandon, University of Hyderabad, Hyderabad

- **Cultural Events Committee**

R. Tandon, University of Hyderabad, Hyderabad, *Chair*
J. Anuradha, University of Hyderabad, Hyderabad
S. Kesavan, Institute of Mathematical Science., Chennai
M. S. Raghunathan, Tata Institute of Fundamental Research, Mumbai

- **Publicity Committee**

M. S. Raghunathan, Tata Institute of Fundamental Research, Mumbai, *Chair*
S. Kesavan, Institute of Mathematical Science, Chennai
R. Ramachandran, 'The Hindu', New Delhi
G. Rangarajan, Indian Institute of Science, Bangalore
Rahul Roy, Indian Statistical Institute, New Delhi
R. Tandon, University of Hyderabad, Hyderabad

- **General Assembly Committee**

G. Misra, Indian Institute of Science, Bangalore, *Chair*
Tirthankar Bhattacharyya, Indian Institute of Science, Bangalore
Shobha Madan, Indian Institute of Technology, Kanpur
Mythily Ramaswamy, Tata Institute of Fundamental Research, Bangalore
G. Rangarajan, Indian Institute of Science, Bangalore
T. S. S. R. K. Rao, Indian Statistical Institute, Bangalore
I. S. Shivakumara, Bangalore University, Bangalore

- **Publications Committee**

Rajendra Bhatia, Indian Statistical Institute, New Delhi, *Chair*
Pablo Arés Gastesi, Tata Institute of Fundamental Research, Mumbai
Arup Pal, Indian Statistical Institute, New Delhi
G. Rangarajan, Indian Institute of Science, Bangalore
V. Srinivas, Tata Institute of Fundamental Research, Mumbai
M. Vanninathan, Tata Institute of Fundamental Research, Bangalore

II. IMU Committees for ICM 2010

- **Program Committee ICM 2010**

Hendrik W. Lenstra, Universiteit Leiden, Netherlands, *Chair*
Jeanine Daems, Universiteit Leiden, Netherlands, *Assistant to the Chair*
Louis H. Y. Chen, National University of Singapore, Singapore
José Antonio de la Peña, Universidad Nacional Autónoma de México, Mexico
Etienne Ghys, CNRS – École Normale Supérieure de Lyon, France
Ta-Tsien Li, Fudan University, Shanghai, China
Dusa McDuff, Barnard College, Columbia University, New York, U. S. A.
Alfio Quarteroni, École Polytechnique Fédérale de Lausanne, Switzerland and Politecnico di Milano, Italy
S. Ramanan, Chennai Mathematical Institute, India
Terence Tao, University of California, Los Angeles, U. S. A.
Eva Tardos, Cornell University, Ithaca, U. S. A.
Anatoly Vershik, St. Petersburg Branch of Steklov Mathematical Institute, St. Petersburg, Russia

- **Sectional Panels of the Programme Committee**

Panel 1, Logic and foundations

Theodore Slaman, University of California, Berkeley, U. S. A., *Chair*
Alain Louveau, Université de Paris VI, France
Ehud Hrushovski, Hebrew University, Jerusalem, Israel
Alex Wilkie, University of Manchester, U. K.
W. Hugh Woodin, University of California, Berkeley, U. S. A.

Panel 2, Algebra

R. Parimala, Emory University, Atlanta, U. S. A., *Chair*
David Eisenbud, University of California, Berkeley, U. S. A.
Maxim Kontsevich, Institut des Hautes Études Scientifiques, Bures-sur-Yvette, France
Gunter Malle, Universität Kaiserslautern, Germany
Alexander S. Merkurjev, University of California, Los Angeles, U. S. A.
Vladimir L. Popov, Steklov Institute, Moscow, Russia
Raphael Rouquier, University of Oxford, U. K.
Michel Van den Bergh, Universiteit Hasselt, Belgium

Panel 3, Number Theory

Ramachandran Balasubramanian, Institute of Mathematical Sciences, Chennai, India, *Chair*
Bas Edixhoven, Universiteit Leiden, Netherlands
Eduardo Friedman, Universidad de Chile, Santiago, Chile

Ben Green, University of Cambridge, U. K.
 Michael Harris, Université de Paris VII, France
 Gérard Laumon, Université de Paris XI, Orsay, France
 David Masser, Universität Basel, Switzerland
 Noriko Yui, Queen's University, Kingston, Canada
 Shou-Wu Zhang, Columbia University, New York, U. S. A.

Panel 4, Algebraic and Complex Geometry

Claire Voisin, Institut des Hautes Etudes Scientifiques, Bures-sur-Yvette, France, *Chair*
 Lawrence Ein, University of Illinois at Chicago, U. S. A.
 Barbara Fantechi, International School for Advanced Studies, Trieste, Italy
 Jun-Muk Hwang, Korea Institute for Advanced Study, Seoul, Korea
 Grigory Mikhalkin, University of Toronto, Canada
 Madhav Nori, University of Chicago, U. S. A.
 Burt Totaro, University of Cambridge, U. K.

Panel 5, Geometry

Harold Rosenberg, Instituto Nacional de Matemática Pura e Aplicada, Rio de Janeiro, Brazil, *Chair*
 Dmitri Burago, Pennsylvania State University, University Park, U. S. A.
 Ursula Hamenstädt, Rheinische Friedrich-Wilhelms-Universität Bonn, Germany
 Michael Kapovich, University of California, Davis, U. S. A.
 John Morgan, Columbia University, New York, U. S. A.
 Brian White, Stanford University, U. S. A.
 Weiping Zhang, Nankai University, Tianjin, China

Panel 6, Topology

Karen Vogtmann, Cornell University, Ithaca, U. S. A., *Chair*
 Ian Agol, University of California, Berkeley, U. S. A.
 Eleny Ionel, Stanford University, U. S. A.
 Haynes Miller, Massachusetts Institute of Technology, Cambridge, U. S. A.
 Shigeyuki Morita, University of Tokyo, Japan
 Peter Ozsvath, Columbia University, New York, U. S. A.
 Ulrike Tillmann, University of Oxford, U. K.

Panel 7, Lie Theory and Generalizations

David Vogan, Massachusetts Institute of Technology, Cambridge, U. S. A., *Chair*
 Victor Ginzburg, University of Chicago, U. S. A.
 Masaki Kashiwara, Kyoto University, Japan

Jian-Shu Li, Hong Kong University of Science and Technology, Hong Kong
Elon Lindenstrauss, Princeton University, U. S. A. and Hebrew University, Jerusalem, Israel
Madabusi S. Raghunathan, Tata Institute of Fundamental Research, Mumbai, India
Ernest Borisovich Vinberg, Moscow State University, Russia

Panel 8, Analysis

Alberto Grünbaum, University of California, Berkeley, U. S. A., *Chair*
Kari Astala, University of Helsinki, Finland
David Bekollé, University of Ngaoundere, Cameroun
Ewa Damek, University of Wrocław, Poland
Stanislav Smirnov, Université de Genève, Switzerland
Xavier Tolsa, Universitat Autònoma de Barcelona, Spain
Alexander Veselov, Loughborough University, U. K.

Panel 9, Functional Analysis and Applications

Sorin Popa, University of California, Los Angeles, U. S. A., *Chair*
Claire Anantharaman-Delaroche, Université d'Orléans, France
Marek Bożejko, University of Wrocław, Poland
Nigel Higson, Pennsylvania State University, University Park, U. S. A.
Bernard Maurey, Université de Paris VII, France

Panel 10, Dynamical Systems and Ordinary Differential Equations

Albert Fathi, École Normale Supérieure de Lyon, France, *Chair*
Shrikrishna Gopalrao Dani, Tata Institute of Fundamental Research, Mumbai, India
Vadim Kaloshin, University of Maryland, College Park, U. S. A.
Bryna Kra, Northwestern University, Evanston, U. S. A.
Mary Rees, University of Liverpool, U. K.
José Antonio Seade Kuri, Universidad Nacional Autónoma de México, Cuernavaca, Mexico
Dmitry Treschev, Steklov Mathematical Institute, Moscow, Russia

Panel 11, Partial Differential Equations

Patrick Gérard, Université de Paris XI, Orsay, France, *Chair*
Luigi Ambrosio, Scuola Normale Superiore, Pisa, Italy
Vladimir S. Buslaev, St. Petersburg State University, Russia
Mónica Clapp, Universidad Nacional Autónoma de México, Mexico
Miguel A. Herrero, Universidad Complutense, Madrid, Spain
Jiaxing Hong, Fudan University, Shanghai, China
Vladimir Šverák, University of Minnesota Twin Cities, Minneapolis, U.S.A.
Neil Trudinger, Australian National University, Canberra, Australia

Yoshio Tsutsumi, Kyoto University, Japan
Maciej Zworski, University of California, Berkeley, U. S. A.

Panel 12, Mathematical Physics

Giovanni Gallavotti, Università di Roma “La Sapienza”, Italy, *Chair*
Michio Jimbo, Rikkyo University, Tokyo, Japan
Krzysztof Gawedzki, École Normale Supérieure de Lyon, France
Nicolai Reshetikhin, University of California, Berkeley, U. S. A.
Barry Simon, California Institute of Technology, Pasadena, U. S. A.
Edward Witten, Institute for Advanced Study, Princeton, U. S. A.
Jakob Yngvason, Universität Wien, Austria

Panel 13, Probability and Statistics

Srinivasa Varadhan, Courant Institute of Mathematical Sciences, New York, U.S.A., *Chair*
Jianqing Fan, Princeton University, U. S. A.
Pablo Ferrari, University of São Paulo, Brazil
Jayanta K. Ghosh, Purdue University, West Lafayette, U. S. A.
Edwin Perkins, University of British Columbia, Vancouver, Canada
Dominique Picard, Université de Paris VII, France
Wendelin Werner, Université de Paris XI, Orsay, France

Panel 14, Combinatorics

Béla Bollobás, University of Cambridge, U. K., *Chair*
Alexander Barvinok, University of Michigan, Ann Arbor, U. S. A.
Peter Cameron, University of London, U. K.
David Jackson, University of Waterloo, Canada
Andrei Okounkov, Princeton University, U. S. A.
Imre Ruzsa, Alfréd Rényi Institute of Mathematics, Budapest, Hungary

Panel 15, Mathematical Aspects of Computer Science

Christos Papadimitriou, University of California, Berkeley, U. S. A., *Chair*
Manindra Agrawal, Indian Institute of Technology, Kanpur, India
Xiaotie Deng, City University of Hong Kong, Hong Kong
Irit Dinur, Weizmann Institute of Science, Rehovot, Israel
Dmitry Grigoryev, Université Lille 1, France
Anna Karlin, University of Washington, Seattle, U. S. A.
Toniann Pitassi, University of Toronto, Canada
Joachim von zur Gathen, Rheinische Friedrich-Wilhelms-Universität Bonn, Germany

Panel 16, Numerical Analysis and Scientific Computing

Philippe Ciarlet, City University of Hong Kong, Hong Kong, *Chair*
Franco Brezzi, Istituto Universitario di Studi Superiori, Pavia, Italy

James Demmel, University of California, Berkeley, U. S. A.
Ronald DeVore, University of South Carolina, Columbia, U. S. A.

Panel 17, Control Theory and Optimization

Michel X. Goemans, Massachusetts Institute of Technology, Cambridge,
U. S. A., *Chair*
Andrei Agrachev, International School for Advanced Studies, Trieste,
Italy
Frédéric Bonnans, École Polytechnique, Palaiseau, France
Stephen Boyd, Stanford University, U. S. A.
Arkadi Nemirovski, Georgia Institute of Technology, Atlanta, U. S. A.
Enrique Zuazua, Basque Center for Applied Mathematics, Bilbao, Spain
Karl Kunisch, Karl-Franzens-Universität Graz, Austria

Panel 18, Mathematics in Science and Technology

Peter Deuffhard, Konrad-Zuse-Zentrum für Informationstechnik, Berlin,
Germany, *Chair*
Peter Donnelly, University of Oxford, U. K.
Nicole El Karoui, École Polytechnique, Palaiseau, France
Avner Friedman, Ohio State University, Columbus, U. S. A.
Mete Soner, Sabanci University, Istanbul, Turkey
Jia-An Yan, Academia Sinica, Beijing, China

Panel 19, Mathematics Education and Popularization of Mathematics

Bill Barton, University of Auckland, New Zealand, *Chair*
Claudi Alsina, Universitat Politècnica de Catalunya, Barcelona, Spain
Ubiratan d'Ambrosio, Universidade Estadual de Campinas, Brazil
Kristina Reiss, Ludwig-Maximilians-Universität München, Germany
Alan Schoenfeld, University of California, Berkeley, U. S. A.
Anna Sierpinska, Concordia University, Montréal, Canada
K. Subramaniam, Tata Institute of Fundamental Research, Mumbai, India
Jianpang Wang, East China Normal University, Shanghai, China

Panel 20, History of Mathematics

Michio Yano, Kyoto Sangyo University, Japan, *Chair*
Henk J.M. Bos, Universiteit Utrecht, Netherlands and University of
Aarhus, Denmark
Karine Chemla, Université de Paris VII, France
Joseph W. Dauben, City University of New York, U. S. A.
Jeremy Gray, Open University, Milton Keynes, U. K.

- **Fields Medal Committee for 2010**

László Lovász, Eötvös Loránd University, Budapest, Hungary, *Chair*
Corrado De Concini, Università di Roma, La Sapienza, Italy
Yakov Eliashberg, Stanford University, U. S. A.
Timothy Gowers, University of Cambridge, U. K.
Peter Hall, University of Melbourne, Australia
Ngaiming Mok, University of Hong Kong, Hong Kong
Stefan Müller, Institute for Applied Mathematics, University of Bonn, Germany
Peter Sarnak, Institute for Advanced Study, Princeton, U. S. A.
Karen Uhlenbeck, University of Texas, Austin, U. S. A.

- **Rolf Nevanlinna Prize Committee for 2010**

Ravindran Kannan, Microsoft Research Labs, India, *Chair*
Stanley Osher, University of California, Los Angeles, U. S. A.
Olivier Pironneau, University of Paris VI, France
Madhu Sudan, MIT and Microsoft Research, U. S. A.
Emo Welzl, ETH, Zürich, Switzerland

- **Carl Friedrich Gauss Prize Committee for 2010**

Wolfgang Dahmen, RWTH, Aachen, Germany, *Chair*
Rolf Jeltsch, ETH, Zürich, Switzerland
Servet Martinez Aguilera, Universidad de Chile, Chile
William R. Pulleybank, IBM, U. S. A.

- **Chern Medal Committee for 2010**

Phillip A. Griffiths, Institute for Advanced Study, Princeton, U. S. A.,
Chair
Robert Bryant, MSRI, Berkeley, U. S. A.
Gerd Faltings, Max Planck Institute for Mathematics, Bonn, Germany
Fanghua Lin, Courant Institute, New York University, U. S. A.
Wendelin Werner, Université Paris-Sud 11, France

- **Emmy Noether Lecture Committee for 2010**

Cheryl Praeger, University of Western Australia, Perth, Australia, *Chair*
Christine Bessenrodt, Leibniz University, Hannover, Germany
Jerrold E. Marsden, California Institute of Technology, Pasadena, U. S. A.
Sujatha Ramadorai, Tata Institute of Fundamental Research, Mumbai, India

- **Travel Grants Committee for 2010**

Marcelo Viana, IMPA, Rio de Janeiro, Brazil, *Chair*

Charles Herbert Clemens, Ohio State University, Columbus, U. S. A.

Shrikrishna G. Dani, Tata Institute of Fundamental Research, Mumbai,
India

Wilfrid Gangbo, Georgia Institute of Technology, Atlanta, U. S. A.

Zhi-Ming Ma, Institute of Applied Mathematics, CAS, Beijing, China

Anatoly Vershik, St. Petersburg State University, Russia

Opening Ceremony, 19 August 2010

M. S. Raghunathan, Chairman of the Executive Organizing Committee

Respected Rashtrapatiji, Honourable Governor of Andhra Pradesh, Honourable Chief Minister of Andhra Pradesh, delegates to the Congress, ladies and gentlemen,

It gives me great pleasure to extend to you all a warm welcome to this inaugural function. We are grateful to the honourable President of India for kindly agreeing to be the Chief Guest and to inaugurate this function today. We are also greatly honoured by the presence of the Honourable Governor, Shri E. S. L. Narasimhan and the Honourable Chief Minister, Shri K. Rosaiah on this occasion. I extend them all a warm welcome.

The International Congress of Mathematicians has more than a hundred year old history and it is, by far, the most important, prestigious and biggest international gathering of mathematicians, which takes place once every four years. It is for the first time that India is hosting this event. It is, thus, a really historic landmark in the annals of Indian mathematics. On behalf of the Indian mathematical community, I would like to thank the International Mathematical Union for giving us this opportunity to hold this Congress and welcome mathematicians from all over the world to India, and to Hyderabad, the venue of the Congress. This is really a great opportunity for the Indian community to interact with the finest mathematical minds from all over the world, an opportunity which we are very grateful for.

The Programme Committee, chaired by Professor H. W. Lenstra, is offering us a veritable mathematical feast. I am sure the delegates will have a very fruitful and enjoyable time during the Congress. I extend a special welcome to the invited speakers and the prize winners and also offer my congratulations to them. Thank you.

László Lovász, President of the International Mathematical Union

Madam President, Honourable Governor, Honourable Chief Minister, ladies and gentlemen,

The International Congress of Mathematicians is a very old tradition, more than a century old. And it has been the



lynchpin holding together the community of mathematicians internationally. It gives us a chance to award our main prizes. It gives us a possibility to survey recent developments in all fields of mathematics. It also gives the forum for discussions of important issues in mathematical life.

There is, usually, quite a competition for the right to organize this Congress which takes place every fourth year. This time, India has won the competition and this is, indeed, justified because India has a very long tradition in mathematics. Without going into details, I can mention Bhaskara, the development of our number system, Ramanujan, whose work is still an inspiration in a large number of branches of mathematics, and our colleagues in India and of Indian origin all over the world who are doing outstanding research in mathematics and also in related fields like computer science.

This event should contribute to further development of mathematical research and mathematical education not only in India but also, indeed, all over the world. I wish you an inspiring, pleasant and fruitful stay in Hyderabad and I hope that you will go home with a feeling that you have taken part in something which is a unique event – it happens every fourth year, it happened for the first time in India; and that this event will give you inspiration for the next four years. Thank you.

The Chief Minister of Andhra Pradesh, Shri Konijeti Rosaiah

I am happy to be here at the inauguration of this important mathematical event. I extend a warm welcome to all the delegates to Hyderabad. It is a cosmopolitan city steeped in history and has a composite culture drawing from diverse traditions. It is a striking contrast between the old and the new.

Hyderabad hosts many educational and research institutions. The University of Hyderabad is among the top universities in the country. It has been rated as number 1 in India by Scopus based on the impact factor of its publications. There are eleven other universities in the city, Osmania being the oldest with a history of over a hundred years. The Centre for Cellular and Molecular Biology, The National Geophysical Research Institute and the Centre for DNA Fingerprinting and Diagnostics are among the leading institutes for scientific research in the country. The city offers stiff competition to Bangalore as a hub for the IT industry. This conference is located in an area of the city which is popularly known as Cyberabad.

In Andhra we have always had a great regard for mathematicians. There is a famous Telugu proverb which says:

Lakke lunna varu nijamaina managaadu

meaning

One who is good at calculations is a great man.

Amaravati in our state was an ancient seat of learning particularly famous for Buddhist studies. The study of logic was very much a part of Buddhist philosophical studies and was connected intimately with foundational issues in

mathematics. In recent years many mathematicians from Andhra Pradesh have distinguished themselves. Professor C. R. Rao ranks among the leading international figures in Statistics. Professor S. Minakshisundaram's contributions to the study of the Heat Equation are well known to the mathematical community. Professor K. Chandrasekharan was the architect of the School of Mathematics of the Tata Institute of Fundamental Research in Mumbai. Professor K. G. Ramanathan, who helped Chandrasekharan build that school, taught at Osmania University. We are indeed proud of the contributions of these outstanding mathematicians from Andhra Pradesh.

We recognise the importance of mathematics as a discipline as well as a tool in science and technology, and in many other practical matters. The Congress will focus public attention on mathematics even if your deliberations are beyond ordinary people. Raising awareness of mathematics among people is important and the Congress will do that. I find that the organisers have arranged two talks aimed at high school and college students in the city. I am happy to see this initiative in the midst of a busy programme concerned with high level research.

We are happy that Hyderabad was chosen to host the Congress by the Indian organisers and their bid was accepted by the International Mathematical Union. My government has always encouraged the promotion of top level academic interaction between scientists. We have given unstinted support to the Congress. I wish the delegates a very fruitful conference. I urge you to take this opportunity to explore the diverse touristic attractions that the state of Andhra Pradesh, in general, and this great city, in particular, have to offer. You will not be disappointed.

Martin Grötschel, Secretary of the International Mathematical Union

Honourable President of India, ladies and gentlemen, dear fellow mathematicians,

I have the great honor and particular pleasure to announce this year's Fields Medalists. As you have already heard, the Fields Medals carry the highest prestige of all awards in mathematics. This prestige does not derive from the value of the cash award, but from the superb mathematical qualities of the previous Fields Medal awardees. They all have become monuments of mathematics and are recorded in our history books. The work of the Fields Medalists 2010 belongs to this category. The medals will be handed out by the honorable President of India, IMU President László Lovász will present the cash awards and diplomas, and the Medalist citations will be read by me.

The Fields Medal Committee was chaired by László Lovász, President of IMU, as is the tradition. The committee members were Corrado de Concini, Yakov Eliashberg, Peter Hall, Timothy Gowers, Ngaiming Mok, Stefan Müller, Peter Sarnak and Karen Uhlenbeck. The work of this committee is very hard because contributions of mathematicians aged below 40 have to be judged, which are not necessarily well-known yet across all of mathematics.

The Fields Medals were first awarded in 1936 and recognize outstanding mathematical achievement for existing work and for the promise in future. The medals themselves are about 6 cm in diameter and are made of 14-carat gold. You will rarely have the occasion to touch them, so you can see photos of both sides of the medal on the screen.



Martin Grötschel and the Fields Medalists

The first medalist, in alphabetic order, is Elon Lindenstrauss of Hebrew University, Jerusalem, Israel and Princeton University, Princeton, NJ, USA. The brief citation reads: “*For his results on measure rigidity in ergodic theory, and their applications to number theory.*” You will hear more about Elon’s work and the work of the three other medalists this afternoon.

The second Fields Medalist, in alphabetic order, is Ngô Bao Châu, from the Université Paris-Sud, Orsay, France, but as you can infer from his name, Ngô Bao Châu was born and raised in Vietnam. The short citation is: “*For his proof of the Fundamental Lemma in the theory of automorphic forms through the introduction of new algebro-geometric methods.*”

The third winner of the Fields Medal is Stanislav Smirnov. He is at the Université de Genève in Switzerland, but Stanislav Smirnov is of Russian origin, as you can guess from his name. The brief citation that the Fields Medal Committee phrased is: “*For the proof of conformal invariance of percolation and the planar Ising model in statistical physics.*”

The fourth Fields Medalist is Cédric Villani. Cédric is from the Institut Henry Poincaré, Paris, France. His citation reads: “*For his proofs of nonlinear Landau damping and convergence to equilibrium for the Boltzmann equation.*”

Ravindran Kannan, Chairman of the Rolf Nevanlinna Prize Committee

Honourable President,

These are the members of the committee and I want to thank them for all the hard work they put in – Stanley Osher, Olivier Pironneau, Madhu Sudan and Emo Welzl. And now, we are ready to announce the winner of the Nevanlinna Prize. First, we will show you the medal (screen display). As Martin said, may be you will not get to hold it but you can see it. The candidate must be forty or under to get this prize.

And now, I am ready to announce the winner of the Nevanlinna Prize, and the winner is Daniel Spielman. And the brief citation reads: “*For smooth analysis of linear programming algorithms and algorithms for graph based codes, applications of graph theory to numerical computing.*”

Wolfgang Dahmen, Chairman of the Carl Friedrich Gauss Prize Committee

Honourable President, dear colleagues,

As the chairman of the Gauss Prize committee, I have the pleasure now to announce the Gauss Prize. Let me briefly introduce the committee. The members were Rolf Jeltsch, Servet Martinez Aguilera, and William R. Pulleybank.

A brief word on the Gauss Prize itself. As you know, the name Gauss stands for a unique fusion between fundamental contributions in mathematics in so many areas and concrete applications. The back side of the medal shows one such example, namely, the little circle you see there is the small asteroid Ceres. Gauss had developed a new method to predict its re-appearance, and as a by-product, he developed the least squares method which you could view as the father of all statistical estimators symbolised by the little square in the medal that you see. In that very spirit, the award is for outstanding mathematical contributions with a significant and lasting impact on applications, in particular, outside mathematics.

The person to be awarded has been, in the true sense of the word, in fact, in a double sense in this case, in the centre of some activities nicely indicated by this picture (screen display) from a conference that had taken place in 1992 in Oberwolfach. It is now my great pleasure to reveal the identity of this person: the prize is going to be awarded to Professor Yves Meyer. The brief citation is: IMU and DMV (Deutsche Mathematiker Vereinigung) jointly awarded this prize for his fundamental contributions to those results at the interface between harmonic analysis, number theory and operator theory that finally culminated in the new paradigm referred to as multi-resolution analysis with wavelet bases as the focal point. This paradigm really revolutionized modern methodologies in signal processing but had also strong impact far beyond on other application areas such as non-parametric statistical estimation, and even to pre-conditioning systems of equations that appear in large scale numerical simulation. He really created a new way of multi-resolution thinking which convinced the Gauss

committee that Professor Meyer is an outstanding candidate in the very spirit of the award.

Robert Bryant, Chern Medal Committee

It is my honour and pleasure to be invited to announce the award of the first Chern Prize. As a member of the committee, I should say just a word about the committee members. Our chair was Professor Phillip Griffiths; the members consisted of myself, Gerd Faltings, Fanghua Lin, and Wendelin Werner.

The Chern Medal is named for and is in honour of Professor Shiing-Shen Chern who devoted his life to mathematics, both in active research and education and in nurturing the field whenever the opportunity arose. He obtained fundamental results in the area of differential geometry and introduced many students to mathematical research. The medal is to be awarded to an individual whose lifelong outstanding achievements in the field of mathematics warrant the highest level of recognition. It is our pleasure to announce the recipient of this award, Professor Louis Nirenberg. Professor Nirenberg is the principal founder of the modern field of nonlinear elliptic equations, which occupies a central role across mathematics. Professor Nirenberg's broad and fundamental contributions to our field exemplify the qualities recognized by the Chern Medal.

The award will now be presented. I should say, since it is a new award, many people may not realize – the award is made possible by the generosity of the Simons Foundation and the Chern Foundation. It consists of two parts: 250,000 dollars that go to the recipient and 250,000 dollars to be donated to mathematical causes that the recipient chooses.



Louis Nirenberg after receiving the Chern Prize, Smirnov and Spielman are behind him

The President of India, Shrimati Pratibha Devisingh Patil



Ladies and Gentlemen,

It gives me great pleasure to inaugurate the International Congress of Mathematicians, which has a history of over a hundred years, in this beautiful city of Hyderabad. This Conference convened every four years, under the aegis of the International Mathematical Union, is an opportunity for mathematicians from all over the world to discuss developments and advances in this discipline.

First of all, I would like to congratulate the Prize winners. I wish the young Fields Medalists and the Nevanlinna Prize Winner many more years of high mathematical achievement. Those who have been conferred the Gauss Prize and the Chern Prize deserve, apart from our congratulations, our deep appreciation for the service they have rendered to human progress through their profound mathematical work.

To be here, in the midst of outstanding mathematical scholars, is an exhilarating experience. Though I must confess that I am no mathematician, but belonging to a country that has a rich mathematical heritage, and where it has been accorded a primary position among intellectual pursuits, I feel proud that this Conference is being held here. India's engagement with mathematics goes back some three thousand years. An ancient Sanskrit verse states:

यथा शिखा मयूराणां नागानां मणयो यथा ।
तद्वद् वेदांगशास्त्राणं गणितं मूर्ध्नि संस्थितम् ॥

which means:-

Like the crest of the peacock and the jewel of the serpent

Mathematics stands at the helm of all sciences.

Mathematics appears to have acquired an independent identity as an intellectual discipline early in human history. India has been at the forefront in contributing to innovations in arithmetic, algebra and geometry at different periods. The Pythagoras Theorem finds a place in Baudhayana *Sulva Sutra*, a work dating back to 8th century BC. The concept of zero or *shunya* originated from India. Pierre Simon Laplace, a French mathematician, said in the 19th century that, “it is India that gave us the ingenious method of expressing all numbers by the means of ten symbols, each symbol receiving a value of position, as well as an absolute value; a profound and important idea.” The contributions of Aryabhata and Brahmagupta to the development of algebra and astronomy in the 6th and 7th centuries are well recognised. In the 12th century there was Bhaskaracharya. His work 'Leelavati' was the main source in medieval India for learning algebra and arithmetic. The book formulates mathematical problems in verse form addressed to Leelavati, Bhaskara's daughter. It was through scholars from the Middle East that renaissance Europe became acquainted with these Indian developments. However, until the twentieth century, the West seems to have been unaware of Madhava, a mathematician of the 15th century who anticipated the essentials of Calculus. It is only in recent years that the work of the 'Kerala School' has attracted considerable attention from historians of mathematics.

After a somewhat dormant period of almost half a millennium, revival of mathematical activity in India was triggered by the advent of the extraordinary figure of Srinivasa Ramanujan in the early 20th century. Ramanujan's achievements were a source of inspiration for succeeding generations. I hope that, in the midst of your busy schedule, you get an opportunity to see the play titled “A Disappearing Number”, being staged during the course of this Conference. It has, I am informed, references to the relationship between Ramanujan and G.H. Hardy.

Ever since our independence, India has recognised the importance of science as a vehicle for human progress. Mathematics, the language of science and its advancement, is an integral part of India's science policy. Mathematics is a science, but nevertheless stands a little apart from other sciences. Yet, it is mathematical intervention that decisively confers the label 'science' to any intellectual discipline. Mathematics, hence, permeates all sciences. Mathematics has had a big role in the development of Computer Science and Information Technology. There are myriad applications of mathematics in technology; and the mathematics used there is reaching higher and higher levels of sophistication. It is hard, for example, to conceive of any aircraft, any robot, or any

future technology, to be produced without a high level of mathematical precision. In recent years, the influence of mathematics in other fields has also grown enormously. Economics and social sciences, once impervious to mathematics, are coming increasingly under its influence. The need for understanding mathematics is necessary for people in all walks of life— whether engineers or scientists, or those working in the world of industry, finance or social sciences. Its role in other human endeavours apart, we also recognise the profound cultural dimension that the study of mathematics has. There is an aesthetic component to its pursuit, and it inculcates the habit of rational thought and promotes what our first visionary Prime Minister Jawaharlal Nehru called “scientific temper”. It is important that study of mathematics is promoted amongst the young generation.

The International Mathematical Union, under whose auspices the Mathematical Congress is being held for the last 50 years has, I am told, initiated many programmes for the promotion of mathematics in developing countries. I wish them great success in such initiatives. I am also happy that mathematicians from India have been contributing to the work of the IMU and are hosting this Conference.

I congratulate all those who have extended support to the Conference. The Department of Atomic Energy and the Department of Science and Technology of the Government of India, in particular, have made this event – the ICM – possible. I understand that many individuals and corporate entities have also extended generous support. My congratulations go also to the University of Hyderabad, its Vice Chancellor and its Mathematics Faculty in particular, for their role in the organisation of this event.

I extend a warm welcome to all the delegates who have assembled here. To the foreign delegates who have come here, I extend a cordial welcome to India. Many of you, I hope, will find time to savour the rich cultural heritage of our country. The organisers have planned some programmes that would give you glimpses of our country’s rich culture. One interesting event is where Viswanathan Anand, the current World Chess Champion is going to play simultaneously against 40 mathematicians. Chess is a game of moves and strategy. It will now be facing the combined calculated moves of mathematics. I wish you all good luck in this challenge!

In conclusion, I wish you all a very fruitful meeting. This is a great opportunity for the mathematical community to interact. I once again wish the Congress great success.

Thank You.

Jai Hind!

Rajat Tandon, Secretary of the Executive Organizing Committee

Honourable President of India, Honourable Governor of Andhra Pradesh, Honourable Chief Minister of Andhra Pradesh, Vice Chancellor of the University of Hyderabad, dignitaries in the audience and fellow mathematicians,

We are grateful to you, Madam President, for sparing your time to grace this occasion. We are aware that you must be pressed for time, with much more important affairs of state, and we are grateful that you could find the time to come all the way from Delhi to be among us for this function.



I thank our honourable Governor too, for being here. He is the Rector of my university and we know he takes a keen interest in matters academic. Thank you Sir, for the interest that you have shown in our Congress. Thanks are due to our honourable Chief Minister for the unstinted support that his government has given the organizers. Without the support

of his government, the conduct of this event would just not have been possible. We particularly thank the police department for their co-operation.

One of the most enthusiastic supporters of this International Congress has been our Vice Chancellor, Dr Hasnain. The number of ways he has helped our Congress is countless. It would perhaps not be an exaggeration to say that the entire university was put at the disposal of the conference organizers. I thank you Sir, for your infectious enthusiasm and support.

I would like to thank the Department of Atomic Energy for providing funds for the Congress as well as the Department of Science and Technology for supporting many of the delegates who are present here today. Thanks are due to the International Mathematical Union for supporting our bid to hold the Congress and for constantly helping us in the organization of the Congress. The Prime Minister's office has helped us in many ways and deserves thanks too. I would like to thank the Press for their continuous coverage of events leading up to the Congress, particularly The Hindu, which has provided coverage of not only the Congress but mathematics in general.

I would like to thank all the private donors to our Congress. Special mention must be made of Mr R. Thyagarajan, Chairman of the Sriram Group of Companies, and Infosys Technologies Limited and its Chairman Mr N. R. Narayana Murthy, for their extraordinary generosity. We thank also Microsoft, Reliance Capital, and Dr Anji Reddy for their support.

I would like to thank the London based theatre group Complicite for timing their visit to India with that of ICM, so that the play would be available for viewing of the delegates. Thanks are also due to the two artists who will be performing before all of you assembled here, Professor C. V. Chandrasekhar

and his troupe and Ustad Rashid Khan. I must also make a mention of Grand Master Viswanathan Anand, who has found time for us in between two of his tournaments.

I profusely thank all the plenary and invited speakers and special speakers who have given their time and effort to speak at this Congress. I thank all the delegates for choosing to come to India and to attend this Congress, and I hope they find their time in India most enjoyable. All our volunteers deserve special thanks for working tirelessly night and day.

Lastly, on a more personal note, I thank my colleagues in the Organizing Committee, my colleagues in my department and my office staff. They have worked relentlessly for the last two years. The organization of a conference of this kind is an incredible team effort. There are a large number of workers whose contribution is crucial to the running of the Congress. I would not be able to thank them all. For this, I beg their forgiveness. However, they can rest assured that in spite of this, we are truly grateful to them. Thank you.

(The President of India leaves)

László Lovász

Ladies and gentlemen,

The inaugural function in the presence of the Indian President has now finished, but we have some traditional functions to perform. And so, I would like to ask you to bear with me a little bit. There are some things we have to do.

One of these traditions is that we commemorate those of our colleagues worldwide who passed away during the last four years. In this case, there are three losses which are particularly severe. During the last four years, Henri Cartan, great mathematician who was the President of the IMU from 1967 to 1970, passed away. Vladimir Arnold, who was the Vice President of IMU from 1999 to 2002, passed away. And Kiyosi Itô, who was the winner of the Gauss Prize just four years ago, passed away. I propose that we stand up for a minute in their memory, and also of all of our colleagues worldwide who died.

Another important step is to reveal our Program Committee. The ICM program has been put together by a committee chaired by Hendrick Lenstra. And all, except the name of the committee chair, has not been made public until this moment in order to protect the committee from undue influence. The members of the Program Committee were Louis Chen, Dusa McDuff, Etienne Ghys, Ta-Tsien Li, José Antonio de la Peña, Alfio Quarteroni, S. Ramanan, Terence Tao, Eva Tardos and Anatoly Vershik. I think that among the many very hard tasks connected with organizing the Congress, the Program Committee has one of the hardest and perhaps, one of the most important. We see the result of their work. We have a list of invited speakers – I personally think that it is a great list. We are looking forward to a very high level and very interesting mathematical program. And this is due to the fantastic work of this Program Committee. So, let us give them applause.

Another step that I would like to propose is, that as is the tradition, we elect a President of the Congress. The President of the Congress is elected by acclamation. I propose that we elect Professor M. S. Raghunathan for this function.

As you all know, the General Assembly of the IMU has had its session just before the Congress. And, during that session, a lot of important decisions have been made. The tradition is that these decisions are discussed in detail at the Closing Ceremony. Nevertheless, I think that there are three of these which, perhaps, are best announced now. First of all, we have a new President, Ingrid Daubechies. She will start her term next January, and I am very glad that she accepted this job, and that she is present here. She is the first woman to be President of the International Mathematical Union. The General Assembly decided that the site of the next ICM will be in Seoul, South Korea, and again, at the Closing Ceremony, you will have much more to hear about this. One of the most important decisions of the General Assembly was to decide that the IMU should have a permanent office. The permanent office will be in Berlin. You will learn more about this. Congratulations, and thanks to all colleagues who made this possible.

For obvious reasons we have left vague some points in this afternoon's program. There will be laudations for the prize winners, for the Fields medalists and the Nevanlinna Prize winner. Harry Furstenberg will be the laudator for Elon Lindenstrauss, Jim Arthur will speak about the work of Ngô Bao Châu, Harry Kesten will speak about Stanislav Smirnov, Horng-Tzer Yau will speak about Cédric Villani, and Gil Kalai will speak about Daniel Spielman. Tomorrow, we have a special occasion; because the Chern Prize is new, we also inaugurate this new prize. The winner, Louis Nirenberg, has received the prize but laudation on his work by Yan Yan Li will happen tomorrow. Ingrid Daubechies will speak about the work of Yves Meyer, the Gauss Prize winner.

Let me call your attention to the fact that you will find more about the prize winners on the home page of the ICM after 12:30 today. Also, talks by the Fields medalists and by the Nevanlinna prize winner are scheduled for the period 13:45 to 14:45 on the next five working days of the Congress.

While these are the announcements you have been waiting for with excitement, there are other prizes that are connected to the IMU or to this ICM. There is the Leelavati Prize, which is a new prize. At the moment, it is a one-time prize by the Indian government for popularization of mathematics, and it is named after a twelfth century Indian mathematical text. It will be awarded at the Closing Ceremony. I want to mention the other prize which is given by the Abel Foundation, but the IMU nominates members to the prize committee. Here are the winners of the last four Abel Prizes – Srinivasa Varadhan in 2007, John Thompson and Jacques Tits in 2008, Mikhail Gromov in 2009 and John Tate in 2010. There is an Abel Prize Lecture by Srinivasa Varadhan scheduled for this afternoon. I propose that we congratulate the prize winners.

There is one more prize which is especially important for us this is the Ramanujan Prize. It is given by the ICTP and is financed by the Abel Foundation. The IMU appoints members to the prize committee, and we cooperate with the

ICTP in many other respects connected with this prize. This year's prize has not yet been announced. In 2006 Ramdorai Sujatha, in 2007 Jorge Lauret, in 2008 Enrique Pujals and in 2009 Ernesto Luperico received this prize. Again, let us congratulate them.

And finally, I would like to inaugurate the *Hyderabad Intelligencer*, edited by S. G. Dani, and I hope that you enjoy reading this publication. Now I ask Martin Grötschel to make some other presentations about the IMU.

Martin Grötschel

From what you have heard before, it may look like IMU is only awarding prizes and electing officers. No, IMU does much more. The IMU Executive Committee and the other IMU commissions and committees are working hard on many aspects of mathematics. It is not possible to present here all of ICMI's work for mathematical education, such as the ICMI studies, or the CDE/DCSG activities for mathematics in the developing world, like the report on Mathematics in Africa: Challenges and Opportunities, and so on.

I take this occasion to point to only a few topical items and I do hope that they are of interest for you. The work I will mention is mainly due to CEIC, IMU's Committee on Electronic Information and Communication.

This committee has produced a number of reports that can be downloaded from IMU's homepage. CEIC has written various recommendations on information and communication for mathematical authors, librarians and publishers. Valuable sources of information are the reports on *Best Practices for Retrodigitization* and the *Vision for the Future of Digital Mathematics Libraries*.

I want to invite you to read the document Citation Statistics that deals with impact factors and the like and analyzes the use and misuse of citation data in the assessment of scientific research. Many universities around the world, especially the administrators, are trying to rate the work of mathematicians by the impact factor or variants thereof. The Citation Statistics report reveals that the impact factor does not suit as a proper measure to rate the scientific quality of an individual person or department, not even a journal. And it shows how one can manipulate these bibliometric data which are claimed to be "simple and objective". But this judgment is unfounded. Douglas N. Arnold and Kristine K. Fowler have recently written the paper Nefarious Numbers in which they report, among other things, on some spectacular cases of misuse. In fact, impact factors and the like can now be viewed not as a matter of statistics, but of game theory. You play against the statistics and try to improve your rating. IMU is making an attempt to provide you with arguments against those administrators who believe that they can rank you and your work and compare your achievements with colleagues in other fields by computing some citation statistics.

At the meeting of the IMU General Assembly two days ago in Bangalore, the GA delegates endorsed a document called *Best Current Practices for Journals* that discusses journal related issues such as quality control, dissemination, archiving, transparency of the editing process, integrity of the persons involved, and professionalism. This document will be uploaded today on IMU's Web

page. It will help you make decisions about buying or subscribing to mathematical journals, about submitting papers to journals, or about getting involved as editors of journals.

Some words concerning ICM issues. You know that the series of our International Congresses started in 1897. Two members of the current IMU Executive Committee, Salah Baouendi and Ragni Piene, did very careful and exhaustive work to collect the names of all persons who have ever spoken at an ICM as a plenary or invited speaker or in a particular function. Now, this collection of speakers is available and searchable on the IMU Web page.

My last activity on this stage today is to inaugurate a new Web page, which is the page where the digital versions of all ICM Proceedings of all time can be found. It contains all articles published in these proceedings in various formats. The whole collection is searchable in several ways. I now try to make a live search. I type "Hilbert", a name you probably all have heard of, into the search field. Let's see what happens: Yes, this is live, more than 20 entries appear, among them five papers by Hilbert himself. And now I click on the Hilbert paper in the second line entitled *Sur les problèmes futurs des Mathématiques*. It is downloaded from the IMU server in Berlin, and here it is.

The paper I just downloaded is probably the most famous paper ever published in the Proceedings, one of the most important mathematical articles of all time. It is the paper in which David Hilbert outlined the 23 problems he considered of highest importance in the year 1900. This open problems collection influenced the development of mathematics very significantly throughout the last century.

Of course, putting together such a collection with all its functionalities is a major piece of work which usually is not done automatically and for free. That the use of this collection is completely free of charge for everyone is due to the fact that all publishing houses involved have granted IMU the right to digitize these books and that IMU engaged two volunteers, R. Keith Dennis of Cornell University, Ithaca, USA and Ulf Rehmann, Universität Bielefeld, Germany, who did all the digitization for love of mathematics. Thank you Keith and Ulf, and please give them a really big applause.

This finishes my brief presentation about what IMU is doing. IMU does a lot more, but there is not enough time to report about that here today.

Thank you very much.

M. S. Raghunathan

I welcome you all again in my new capacity as President of the ICM. I do not know how it is different from being the Chairman of the Organizing Committee but anyway, let me extend you a welcome. I hope you will find the Congress very fruitful, and all organization satisfactory. Thank you.



Ngô Bau Châ receiving the Fields Medal from the President of India



Cédric Villani, Dan Spielman and Yves Meyer, pleased with the prizes



Stanislav Smirnov and Cédric Villani checking whether they have their own medals

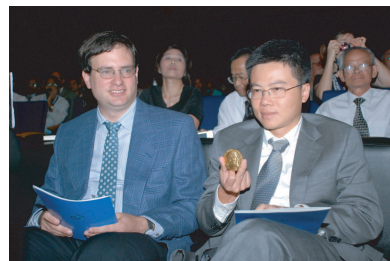

Elon Lindenstrauss and Ngô Bau Châ



Cédric Villani, the best dressed man at the Congress



Elon Lindenstrauss showing his medal



Etienne Ghys and Artur Avila



Claire Voisin and Vikram Mehta



Harry Kesten and Jacob Palis



S. R. S. Varadhan





Dance at the Congress

Closing Ceremony, 27 August 2010

Dinesh Singh, University of Delhi (anchor person)

All good things have to end and it looks like a very good thing is about to end. It has been a delight, it has been a learning experience for all of us and it is something that reinforces our beliefs as mathematicians.

All such conferences require enormous planning, but more than that, they call for boldness of vision, dynamism of effort and steadfastness of purpose. We were fortunate to have them all in our Organising Committee, and particularly so in its Chairman, Professor M. S. Raghunathan.

M. S. Raghunathan

Professor Hasnain, delegates to the Congress, ladies and gentlemen,

I am very happy to welcome you all to this closing function of the ICM 2010. It has been a great experience organizing this. As you all know, it is a collaborative effort of the International Mathematical Union and the Local Organizing Committee. I must add to that the University of Hyderabad, whose Vice Chancellor is present here today. The University of Hyderabad has extended every possible help to us. Many of their staff have worked hard for this Congress. As I said, the IMU and the Local Organizing Committee are partners in this effort, and I have had a very enjoyable collaboration with the IMU Executive Committee. Despite the fact that I am a somewhat laid-back person and the Secretary personifies all thoroughness and efficiency, we did work together very well. And I am very thankful to the EC for their support.

I would also like to take this opportunity to congratulate the prize winners who will be felicitated today and awarded their prizes today: Professor R. C. Gupta for his work on history of mathematics, and Dr. Simon Singh for his work on public outreach for mathematics.

My congratulations to Professor Ingrid Daubechies for taking over as the next President of the IMU, and to Professor Hyungju Park for having won the bid to hold the next Congress – I wish him every success.

The last item on the agenda of the meeting today is the vote of thanks. This is a somewhat quaint business. You hear the person who does the most work for the Congress thank everybody else, and he does not get thanked himself. I would like to extend my thanks to Professor Rajat Tandon for all the immense work he has put in for the Congress.

Dinesh Singh

The Executive Organizing Committee of the ICM was seized of the importance of mathematics reaching out to the public. Towards this end, it has instituted a one-time international prize of one million Indian rupees for outstanding contribution to public outreach for mathematics by an individual. The prize is named the Leelavati Prize. Leelavati is a twelfth century mathematical treatise by the Indian mathematician Bhaskaracharya. In the book, the author poses a series of mathematics problems as challenges to one Leelavati and follows them up with indications of solutions. The problems are in verse form, but not the solutions. This work was the main source for learning mathematics in medieval India. The work was also translated into Persian and was influential in the Middle East.

The Leelavati Prize has been awarded to Dr Simon Singh and it is my pleasant duty on this occasion to read the formal citation: on the occasion of the International Congress of Mathematicians 2010, the Department of Atomic Energy of the Government of India and the Executive Organizing Committee for ICM 2010 are pleased to confer on Dr Simon Singh the Leelavati Prize for outstanding contributions to public outreach for mathematics. Dr Singh has been recognized for his outstanding contributions to the public understanding of mathematics and science and in their promotion in schools, and in building links between universities and schools. His efforts to reach out to the public, both through print and television, have been enormously successful. His book entitled *Fermat's Last Theorem* was a best-seller for several months and was televised to make a hugely popular documentary. Dr Singh has also written *The Code Book*, describing the impact of cryptography on history. This also was converted to a popular five-part serial as a television documentary. More recently, Dr Singh has produced for radio and television *A further five numbers* dealing with five specific numbers of scientific or historical interest. No other author in recent times has caught the public imagination in painstakingly and accurately explaining recent developments in mathematics to them. The Executive Organizing Committee is honoured to confer the Leelavati Prize on Dr Simon Singh.

(Presentation of the award to Dr. Simon Singh.)

Dr Simon Singh

Thank you very much. It is a genuine honour to be receiving this award, the first prize of its kind. I just want to say a few very brief things. One is that the most exciting moments I have had at the Conference have been people come up to me and say that when they read my book as a teenager, it helped inspire their interest in mathematics. And that is a real buzz for me because that is part of the reason that I write my books. Secondly, I think that it is worth mentioning that Martin Gardner passed away earlier this year, and I know many people in

this room have been inspired by Martin's writing, and I myself was very much inspired by his writing.

Two other points I just make very briefly – one is that my parents emigrated from India in 1950, and I think one of the reasons they went to England was to try and benefit my education, and I learnt a great deal in English schools and became fascinated by mathematics and by science and benefitted from Britain's long tradition of excellent education. But having come back to India recently in the last ten years, it is very clear that Indian education is inspiring a new generation of young mathematicians and that is very exciting for me. Sadly, I think English education at the highest level is falling back. So, though I am very proud of the fact that India was moving forward rapidly in this area, it is a shame that in Britain and perhaps in Europe and in America, our schools are not pushing the best and brightest students as far as they possibly could.

Finally, it is an interesting point that my background is really in physics and I write about science and I write about mathematics. Though my first love, was physics when I was a student, now I love mathematics very much too, and I write as much about mathematics as I do about anything else.

Syed E. Hasnain, Vice Chancellor of the University of Hyderabad

Distinguished mathematicians, members of the Press, dear friends,

I remember about three years ago, our Mathematics Department head came to me saying that they would like to host the ICM in India, they will get support from the Government of India, and they want the University of Hyderabad to host it. They asked me to agree and I agreed right away. And today, three years down the road, we see a runaway success. I have been in this hall many times. I have never seen a Congress – a prolonged meeting of nine days, in which the hall is full on the last day. This is a tribute to mathematicians. I salute all of you. Three thousand delegates, eighty five countries, the whole mandate of this ICM was to promote interaction, and I must say the ICM Secretariat must be very happy. It indeed must have fostered lot of interactions, lot of collaborations. I am sure there would be future Fields medallists who would be inspired, who would have been inspired by this meeting.

This meeting was also very unique in having several firsts. It is the first time, of course, it was held in India. It was the first time that a world chess champion, Grand Master Viswanathan Anand, played forty simultaneous matches and he could defeat everybody but had to draw with one small boy, an Indian boy.

We also had Dr Simon Singh receive the Leelavati award instituted by the Government of India, and we will make all efforts to ensure that this award joins the ranks of other prestigious awards and is awarded every four years.

I understand a lot of cultural programmes were organized by groups from my university. The Essence School of Performing Arts had some programmes here. And a newsletter *Reflexions* reported everyday about happenings in the conference. That just goes to show how much involved the entire University of Hyderabad family was in the ICM 2010.

Let me conclude by congratulating all the award winners and thanking the IMU for holding the meeting here in India, in Hyderabad, and requesting the University of Hyderabad to be the host for this meeting. I would also like to thank all my colleagues at the University of Hyderabad, particularly the Secretary EOC, Rajat Tandon.

Dinesh Singh

Thank you, Professor Hasnain.

The International Commission on the History of Mathematics has instituted the Kenneth O. May Prize for outstanding contributions to the field. For the year 2009, this prize has been awarded jointly to Professor Ivor Grattan-Guinness and Professor R. C. Gupta. Professor R. C. Gupta is present here amidst us. He could not receive the prize at Budapest at the ICHM in 2009.

Kim Plofker, International Commission on the History of Mathematics

On behalf of the International Commission on the History of Mathematics of the IMU, I am very happy and greatly honoured to present the 2009 Kenneth O. May Prize to Professor R. C. Gupta. The May Prize is regarded as the highest honour in the field of History of Mathematics, and has been awarded to an eminent senior scholar every four years since its establishment in 1989. This occasion represents the first time it has been bestowed on an Indian historian, or a historian of Indian mathematics, among whom one of the most distinguished examples is Professor R. C. Gupta.

Radha Charan Gupta was born in Jhansi in 1935, and received his B. Sc. from Lucknow University in 1955. He was the first place medalist in the M. Sc. Mathematics examination in Lucknow in 1957, and earned a Ph. D. in the history of mathematics from Ranchi University in 1971. He did his dissertation work at Ranchi with the renowned historian of Indian mathematics T. A. Saraswathi Amma, author of *Geometry in Ancient and Medieval India*, in honour of whom he later endowed the annual memorial lecture of the Kerala Mathematical Association. After serving as a lecturer at Lucknow Christian College in 1957-58, he joined the Faculty of Mathematics of Birla Institute of Technology in Ranchi. He became a professor at BIT in 1982 and emeritus professor at the mandatory retirement age of 60 in 1995. He currently conducts his extensive and varied research and service activities under the aegis of the *Ganita Bharati* Institute, Jhansi.

Since the late 1960s, Professor Gupta's research work has focussed on the history of mathematics in India, particularly the development of trigonometry including interpolation rules and infinite series for trigonometric functions. Among his ground-breaking works in this field are his analysis of Parameswara's third order series approximation for the sine function in the fifteenth century and his examination of the eighth century methods of Govindaswami for interpolating sine tables. Professor Gupta's recent publications, the whole corpus

of which now totals over five hundred items, include chapters on historiography of mathematics in India, area of a bow figure in India, and a little known nineteenth century study of *Ganitasarasangraha*. Besides skillfully analyzing many hitherto unknown ingenious mathematical formulas in elliptical Sanskrit verses, Professor Gupta has published several key papers on the remarkable mathematical discoveries of the Jaina tradition, many of which had been almost inaccessible to anyone except specialists in the Jaina cannon in Prakrit.

This bridge building approach has characterized Professor Gupta's research in general, whether explaining Sanskrit algorithms for a modern mathematical audience, surveying the twentieth century Indian doctoral research on history of mathematics, tracing the influence of Indian mathematical discoveries in foreign traditions, or expounding Jaina, Buddhist or Hindu cosmological theories in the context of early Indian work on transfinite quantities. He has combined scrupulous textual scholarship and expert mathematical exegesis with clear and comprehensive exposition, serving the needs of general audience and specialist researcher alike. No scholar in the twentieth century has done more to advance widespread understanding of the development of Indian mathematics. Professor Gupta has added to his research and teaching, a long record of professional service, expanding awareness of the history of mathematics in general and of Indian mathematics in particular. In 1991, he was elected a Fellow of the National Academy of Sciences, India and in 1994, he became President of the Association of Mathematics Teachers of India. He became a Corresponding Member of the International Academy of History of Science in February 1995 and was more recently elected *Effective Member*. In 1979, he began his decades long service as Founding Editor of the journal *Ganita Bharati* meaning 'Indian mathematics', in which he has published scores of articles and reviews under his own name and the pen name *Ganitanand*, the joy of mathematics. His pedagogical publications and lectures in English and Hindi, as well as his sponsorship of numerous endowed lectures have greatly increased the prominence of history of mathematics in Indian mathematics education and scholarship. Today, we are very pleased and honoured to recognize Radha Charan Gupta with the Kenneth O. May Prize and Medal, awarded for lifetime scholarly achievement and commitment to the field.

(Award to Professor R. C. Gupta)

Radha Charan Gupta

Dear colleagues,

I am really very happy at this occasion to receive this prize, not only because it has ultimately recognized my work but also because it is associated with the memory of late Professor Kenneth O. May with whom I had contact as early as 1968. When he founded the International Commission on History of Mathematics, he took me as a member to represent South Asia. In 1974, when he started the international journal *Historia Mathematica*, I played a role in spreading the message of that journal and did its work in India.

When I became the Editor of the *Ganita Bharati* I played a double role. I brought a world perspective on history of mathematics to Indian scholars and, on the other hand, I facilitated publications on history of Indian mathematics for world scholars. I am happy to see that things have worked.

I hope that this prize, which has come for the first time to India, will encourage Indian scholars to do more work. Thank you.

László Lovász

Ladies and gentlemen,

As President of the IMU, I have two more functions to perform here. Let me start with the first one. I have to report, in a bit more detail, about the main decisions taken by the General Assembly in Bangalore right before this Congress. Let me start with the new Executive Committee which will begin to function next January. Ingrid Daubechies is already introduced to you at the opening ceremony as the new President, Martin Grötschel will stay on as Secretary. Two new Vice Presidents have been elected – Christiane Rousseau and Marcelo Viana. Manuel de León, Yiming Long, Cheryl Praeger, Vasudevan Srinivas, John Francis Toland and Wendelin Werner will be members-at-large. I will have the privilege to stay for four more years *ex-officio* as the past President and I am happy to have this chance to work. I wish the new President and the new Executive Committee a successful term.

A new Commission for Developing Countries was elected by the General Assembly. José Antonio de la Peña will be the President, Herbert Clemens will be Secretary of Policy, Srinivasan Kesavan will be Secretary for Grants, Hoang Xuan Phu will represent Asia, Wandera Ogana will represent Africa and Carlos Cabrelli will represent Latin America in this Commission. Again, congratulations to them and I wish them successful work.

The General Assembly also elected two persons to be delegated to the International Commission on the History of Mathematics – they are Jesper Lützen and Kim Plofker. Congratulations.

I would like to express my thanks at this point to the retiring Executive Committee, even though we still have a hard four months in front of us with all the work around the stable office, to which I will come in a minute. I would like to extend my thanks to those members who are retiring – Zhi-Ming Ma and Claudio Procesi as Vice Presidents, Salah Baouendi, Ragni Piene and Victor Vassiliev as members-at-large. It was great to work with them and I really feel that this Executive Committee was a great team and I wish the next one also has such a spirit. I especially thank John Ball, the Past President, for his help throughout. Without that this Committee could not have functioned. He was always tireless and ever ready to take on any kind of job. Thank you John, and thanks to all the other members.

In connection with the new Commission for Developing Countries, there were two committees which have ceased to exist. They were merged and their functions were combined. One of them was the Commission for Development and Exchange, whose President was Shrikrishna Dani and Secretary-Treasurer

was Gérard Gonzalez-Sprinberg. Graciela Boente, Paulo Cordaro, Jean-Pierre Gossez, Mary Teuw Niane, Marta Sanz-Sole and Jiping Zhang were members. I thank them all for their work over the last term. And we also had a Developing Countries Strategy Group, which was chaired by Herbert Clemens, and consisted of Jill Adler, Hajer Bahouri, John Ball, Shrikrishna Dani, Jean-Pierre Gossez, Andreas Griewank, Jacob Palis, Lê Dung Trang, Peter Pang Yu Hin, Michel Jambu, Sheung Tsun Tsou. I thank all members of this group for doing outstanding work.

This was my first task, and now I would like to ask Ingrid Daubechies to say a few words.

Ingrid Daubechies, President elect of the International Mathematical Union

As was said at the start of the ceremony how things must end. This is the end of this ICM which I enjoyed hugely, and as you can see (pointing to her new Indian costume) I enjoyed not only the mathematics!

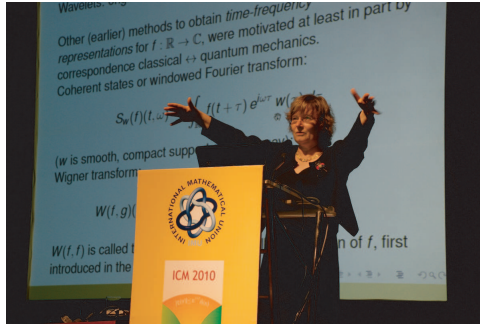

As you have heard from Laci, IMU not only organizes ICMs although that is one of its very important functions, but it also stands for helping developing countries build viable mathematical communities, and for strengthening links between mathematicians who devote their lives to teaching mathematics to younger generations and research mathematicians. I would encourage those of

you who are curious about these other roles of the IMU, or curious about how an ICM gets organized, to visit the website of IMU. And if you would like to get involved, if you would like to contribute, contact the delegates of your country or write to the Executive Committee. We prefer constructive comments to hate mail. But of course, one of IMU's major functions is to organize the next ICM. As I said I enjoyed this one hugely, I have learnt, I have met many new people and I will be working hard on making the next one equally enjoyable.

Hyungju Park, Chair of the Seoul ICM 2014 Organizing Committee

I will start by showing the invitation from the President of the Republic of Korea. The President's office in Korea was involved in this endeavour, in our bidding efforts, from the very beginning and has been very supportive. Not many of you have been to Korea and may not know about it. So I will start by telling you what Korea is like. By the way, you may know the expression 'the land of the morning calms' – this expression was used in a poem. It was a poem written by a well-known Indian poet named Tagore. In this poem he

described Korea as the land of morning calm, apparently he meant Korea was a quiet hidden country. And so, that was then.

Now Korea is considered a leader in the information age. So we have come a long way. And one thing I want to emphasize here is that scholarship is valued very highly in Korea. Illiteracy rate in Korea is close to zero, virtually zero, and often education is the highest priority in any Korean family. And I think that was the principal reason for any progress that we might have made. A few years ago, Korea was the eleventh largest economy in the world. Starting from the ashes of Korean Civil War, that was quite a progress that we made. Unfortunately because of some Asian financial problems, we are now, I think, down to thirteenth probably, in terms of size of the economy. But still we are there, we are vibrant.

And Korea is very accessible. Of course, some people joke that everybody seems to place their country in the centre of the world, well I did! So, Seoul is not far. It takes about twelve hours from Los Angeles, twelve hours from Paris, twelve hours from Rome, and it takes about nine hours from here. So, it is not too far. And we have 'no visa' agreements with one hundred and sixty countries. So, many of you will be able to come to Korea without having to worry about visas. And we wanted to make sure that everybody, every registered participant of ICM, could come visit us in Korea. So, we talked to the Ministry of Foreign Affairs and they wrote that they will do this.

Of course, I have to tell you about the mathematics in Korea. And the expression that I used was 'a long journey'. We have 192 four-year universities and colleges in Korea and 42 of them have Ph.D. programmes in mathematics and mathematics education. The Korean Mathematical Society has about 2700 individual members, of which about 1200 are professors of mathematics. We joined the IMU in 1981 and now we are a Group IV member.

Rapid growth is observed over a broad spectrum. On one end, highest level of mathematical research; on the other end, popularization of mathematics and education. Korea ranked eleventh in terms of number of publications in 2008. Not only quantity of course, but quality research is being carried out and is highly valued and respected in Korea. For example, we have five invited speakers in ICMS, two this time.

In 1981, the number of research papers published by mathematicians based in Korea was three. So we came from three to where we are in less than thirty years. And I think that took a lot of effort from our side and also a lot of support and help from the international community. And this is something we want to remember for long, and want to actually show the world that we have done this and we now want to make another jump.

And as I said rapid growth is observed over a broad spectrum, not only just in research but also in terms of popularization of mathematics and public outreach. For example, that includes the public's growing interest in mathematics. In IMO, International Mathematical Olympiad, Korea has been ranking third or fourth consistently, implying that young students in Korea are genuinely interested in mathematics. And by the way, about 60 to 70 percent of these IMO medalists do choose mathematics as their college major. And many of

them do even end up getting Ph.D. in mathematics. I think this is a singular phenomenon in the world. And also, there are many mathematical research institutes in Korea, and the government is supporting it. We have two main research institutes—KIAS and NIMS, and we have several institutes located at universities. And numerous meetings are being hosted, the most recent one being a joint meeting with the American Mathematical Society.

There is a pledge that we made during our bidding efforts. We offered to invite one thousand mathematicians from developing countries to Korea, all expenses paid. The morale, the rationale, is simple. We came to where we are by the support of the international mathematical community, and we believe that we can return the favour. And we wish to acknowledge the gracious and friendly support from the international mathematical community. I have heard from my own teachers, my college teachers, their experience about being a single Korean participant in ICM, and that was made possible by an IMU travel grant. The professors came back with all the stories to tell, and that excited me and my fellow students. And I am hoping that the same thing can happen in many other countries. This Seoul ICM travel fellowship programme will be prepared in consultation with IMU, especially the newly created Commission for Developing Countries.

I most cordially invite all of you to Seoul.

Rajat Tandon

Professor Hasnain, Professor Lovász, Professor Raghunathan, Professor Daubechies, Professor Park and fellow mathematicians,

A project started four years ago is about to come to an end. I would like to take this opportunity to acknowledge the person who first mooted the idea of bringing the Congress to India: Mr R. M. Puri of the Indian Convention Promotion Board.

Let me begin by thanking our Vice-Chancellor, Professor Seyed Hasnain. In him we found our most ardent supporter. He always backed us to the hilt. I thank the Finance Department of the University of Hyderabad for their support in making the financial processes work as smoothly as possible; the Public Relations Department and our PRO for their help in handling the local media.

Thanks are due to the Executive Committee of the IMU, for constantly supporting us and advising us. A particular word of thanks to Professor Lenstra and the entire Program Committee for providing us with an academic program of the highest standards and widest interest. I thank the invited speakers for their contribution to the Congress.

A word of gratitude for the state and central government departments, and the Prime Minister's Office for helping us when matters came to a crunch. A special word of gratitude for Mr R. Thyagarajan and Mr N. R. Narayana Murthy for their generous support to the Congress.

The cultural items were a great success. I would like to thank Professor J. Anuradha and the students of the Dance Department at the University of Hyderabad. I am thankful to Professor Sunil Mukhi for two excellent lectures

on the appreciation of Hindustani classical music. The London based theatre group Complate came all the way to Hyderabad, and gave us a wonderful play. I thank the producer Judith Dimant, the director Simon McBurney, their manager Cathy Binks and the Prithvi Theatre of Mumbai. I am grateful to grandmaster Viswanathan Anand for the match he played with forty participants. The participants themselves were thrilled, and chess lovers were rewarded with a matchless performance.

The two public lectures were a great success. Both Professors Bill Barton and Gunter Ziegler who gave the lectures were inundated by questions and mobbed like film stars. I was frankly jealous. Profuse thanks to both the speakers.

I would like to take this opportunity to thank my colleagues. Our chairman, Professor Raghunathan, held us all together – his contribution was invaluable. My colleague Professor Amaranath and I were like brothers for the last four years.

Let me not forget to thank the entire HICC team for their support, and the team of KW Conferences for being the second face of the Organizing Committee. My own department staff, Chandrasekhar and Gangaji in particular, have burnt the midnight oil on several occasions. I salute them. Finally I thank all the volunteers who have worked tirelessly for the last ten days.

Fellow delegates, I realize that there were many glitches along the way, that there were problems in logistics, and that sometimes the arrangements were not perfect. To those who have been inconvenienced in any way I offer a sincere word of apology.

Thank you once again for coming to Hyderabad, and making this Congress a great success.

Thank you.

Preface

The Proceedings of the International Congress of Mathematicians 2010 (ICM 2010) consist of four volumes. As is customary, Volumes 2-4 containing texts of invited sectional talks were ready in August 2010 before the Congress took place. Volume 1 has been prepared after the Congress.

This volume is divided into five parts. The first part consists of a report on the organisation of the Congress, the speeches at the Opening and the Closing ceremonies including the presentation of the Fields Medals, the Nevanlinna Prize, the Gauss Prize and the Chern Prize. The second part contains laudations for the prizes. These are descriptions of the work of the prize winners presented by leading authorities. The third part – the main body of the volume – consists of texts of Plenary Talks at the Congress. In the fourth part are presented texts of two special lectures – the Abel Lecture and the Emmy Noether Lecture – and presentations by the Fields Medalists. (One of the winners of the Fields Medal Ngô Bao Châu was also a plenary speaker, and Daniel Spielman, the winner of the Nevanlinna Prize was an invited speaker in Section 15. Their articles appear in the respective sections.) Part five of the volume consists of summaries of panel discussions organised at the Congress, and articles by some of the panelists.

Breaking from tradition, all participants at the ICM 2010 have received a copy of these Proceedings on compact disks. Printed volumes are available on special order. An online version will become available after a few months.

Besides my able co-editors Arup Pal, G. Rangarajan, V. Srinivas, M. Vanninathan and Pablo Gastesi, my colleague Ajit Iqbal Singh has provided valuable support in the tedious jobs of editing, proof-reading and compiling the material. Anil Shukla has handled the large correspondence and records with diligence and competence.

It is a pleasure to thank all the authors for their contribution and their cooperation, the publishers Hindustan Book Agency for their magnificent work in producing these volumes, and the Executive Organising Committee of ICM 2010 for their unstinted support.

January, 2011

Rajendra Bhatia
Chair
Publications Committee of ICM 2010

Editor's Note

The following plenary and invited talks at the Congress are not included in these Proceedings as the speakers did not send their articles.

Plenary Lectures

Peter W. Jones

Eigenfunctions and coordinate systems on manifolds

Stanley Osher

New algorithms in image science

Nicolai Reshetikhin

On mathematical problems in quantum field theory

Invited Talks

T. Januszkiewicz (Section 5)

Simplicial nonpositive curvature

A. Schnirelman (Section 11)

Long-time behaviour of fluid flows

Y. Last (Section 12)

Stability of absolutely continuous spectrum under decaying perturbation: a review of recent developments

P. Chaudhuri (Section 13)

On quantiles in finite and infinite dimensional spaces

S. Sheffield (Section 13)

How do you divide your (two-dimensional) time?

D. Aharonov (Section 15)

Quantum computation and mathematics

P. A. Parrilo (Section 17)

Semidefinite programming and complex algebraic geometry

B. Van Dalen (Section 20)

Islamic astronomical handbooks and their transmission to India and China

Fields Medals

Elon Lindenstrauss

B.Sc. in Mathematics and Physics, The Hebrew University of Jerusalem, 1991;

M.Sc. in Mathematics, The Hebrew University, 1995;

Ph.D. in Mathematics, The Hebrew University, 1999.

Positions held

Member, Institute for Advanced Study, Princeton, 1999-2001.

Szegö Assistant Professor, Stanford University, 2001-2003.

Visiting Member, Courant Institute, New York University, 2003-2005.

Professor, Princeton University, 2004-2010.

Professor, Hebrew University, 2008-

The work of Elon Lindenstrauss

Harry Furstenberg

I've been asked to describe some of the achievements of Elon Lindenstrauss - our Fields medalist. Elon Lindenstrauss's work continues a tradition of interaction between dynamical systems theory and diophantine analysis. This tradition goes back at least to the year 1914 - when Hermann Weyl published a paper entitled "An application of number theory to statistical mechanics and the theory of perturbations." In that paper Weyl used what we would call Kronecker's Theorem to show the validity of the ergodic hypothesis in certain situations. In the meantime the roles have been reversed, with dynamical systems theory and ergodic theory providing the tools for answering questions in number theory.

The number theoretical issues arising in the work of Lindenstrauss have to do with so-called diophantine approximation - in which one asks whether inequalities having real solutions have integer solutions. In this area we encounter a phenomenon which is reminiscent of ergodic behavior. It can be described crudely by saying that whatever is not excluded for some good reason and can happen in principle, will eventually happen - at least approximately. There is a good reason that

$$-\varepsilon < x^2 - (1 + \sqrt{2})^2 y^2 < \varepsilon$$

cannot be solved for small ε (this would imply that $\sqrt{2}$ is well approximable). But this doesn't apply to the three variable inequality:

$$-\varepsilon < x^2 - (1 + \sqrt{2})^2 y^2 - \alpha z^2 < \varepsilon \quad (\alpha \neq 0 \text{ arbitrary})$$

and indeed by the relatively recently established Oppenheim conjecture, for any positive ε , this has a solution in integers (x, y, z) not all 0.

An important advance has come about by enlarging the scope of dynamics to include what will be referred to as "homogeneous dynamics". Ever since Poincaré dynamical theory had broken out of the shackles of Ordinary Differential Equations and a dynamical system comes about whenever we have a 1-parameter group $\{T_t\}$ — think of t as time — of transformations acting in a space X , which we identify as the phase space of the system. We have *homogeneous* dynamics when X is a homogeneous space of a Lie group; we can write $X = G/\Gamma$. For any 1-parameter subgroup $\{g(t)\} \subset G$ we can set $T_t(g\Gamma) =$

$g(t)g\Gamma$. Homogeneous dynamics allows one further abuse of the term “dynamics”, extending the action from a 1-parameter subgroup of G to an arbitrary Lie subgroup $H \subset G$, so that the time parameter can be higher dimensional. This liberalization of viewpoint has been quite fruitful in the recent application of dynamics to number theory.

One particular homogeneous space has been the focus of activity in this work, it is a space that appears implicitly in Minkowski’s geometry of numbers. Namely, for a dimension d , we consider the space Ω_d of unimodular lattices spanned by d independent vectors in \mathbb{R}^d . The group $\mathrm{SL}(d, \mathbb{R})$ acts transitively on this space in a natural way: $\Omega_d \cong \mathrm{SL}(d, \mathbb{R})/\mathrm{SL}(d, \mathbb{Z})$. There is a measure on Ω_d invariant under the action of the group and the measure of Ω_d is finite. Nonetheless the space Ω_d is non-compact in its natural topology. This is important, as is Mahler’s criterion for a set $\Sigma \subset \Omega_d$ to have compact closure. Namely, $\bar{\Sigma}$ is compact unless there is a sequence $\{\sigma_n\} \subset \Sigma$ and vectors $v_n \in \sigma_n$ with $\|v_n\| \rightarrow 0$.

There is a broad spectrum of problems for which this is relevant. Namely, let $\Phi(x_1, x_2, \dots, x_d)$ be a homogeneous polynomial and we ask if for arbitrarily small $\varepsilon > 0$ one can solve $|\Phi(x_1, x_2, \dots, x_d)| < \varepsilon$ in integers not all 0. (This would in fact imply that the range of Φ on \mathbb{Z}^d is dense in either \mathbb{R}^+ , \mathbb{R}^- , or both). Now define the subgroups

$$H_\Phi \subset G = \mathrm{SL}(d, \mathbb{R}) \text{ by } H_\Phi = \{h \in G : \Phi(h\bar{v}) = \Phi(\bar{v}) \text{ for all } \bar{v} \in \mathbb{R}^d\}.$$

In general for a non-compact group H , one expects orbits Hx to be unbounded, and then Mahler’s criterion will come into play. If we take $x_0 \in \Omega_d$ to be the lattice \mathbb{Z}^d , then if $H_\Phi x_0$ is unbounded, this will imply that there exist $h \in H_\Phi$ and $\bar{v} \in \mathbb{Z}^d$ with $\|h\bar{v}\|$ arbitrarily small which means that $\Phi(\bar{v})$ is arbitrarily small. This was the strategy leading to the solution of the Oppenheim conjecture in the 80’s by Margulis. Here $\Phi(x_1, x_2, x_3) = \alpha x_1^2 - \beta x_2^2 - \gamma x_3^2$ and H_Φ has the property investigated by Marina Ratner motivated by conjectures of Raghunathan and Dani - of being generated by unipotent subgroups. (A linear transformation is unipotent if 1 is its unique eigenvalue.) By this theory one can classify all the closed H_Φ -invariant subsets of Ω_3 and in particular, one sees that an H_Φ -orbit has compact closure only if it is already compact. Margulis shows that this can happen to the orbit of $x_0 = \mathbb{Z}^d$ only if α, β, γ are commensurable. Otherwise this orbit is unbounded which leads to the conclusion that $|\Phi(x_1, x_2, x_3)| < \varepsilon$ has integer solutions.

Another notorious diophantine approximation problem is Littlewood’s conjecture: for *all* pairs of real number α, β , if for x real we denote by $\|x\|$ the distance of x to the nearest integer, then

$$\liminf_{n \rightarrow \infty} n \|n\alpha\| \|n\beta\| = 0.$$

This fits into the framework just discussed for the polynomial

$$\psi(x_1, x_2, x_3) = x_1(\alpha x_1 - x_2)(\beta x_1 - x_3)$$

where we disallow $x_1 = 0$. A linear transformation carries this to

$$\Theta(X, Y, Z) = XYZ$$

and H_Θ is (locally) just the diagonal subgroup $\left\{ \begin{pmatrix} e^{-t-s} & 0 & 0 \\ 0 & e^t & 0 \\ 0 & 0 & e^s \end{pmatrix} \right\}$. This

has no non-trivial unipotent subgroups; and the Ratner theory does not apply. Nonetheless, Margulis has conjectured that a bounded orbit for H_θ is necessarily compact and this conjecture, as in the foregoing discussion, has the Littlewood conjecture as a consequence.

We have here a contrast of unipotent homogeneous dynamics with what might be called — with Katok — higher rank hyperbolic dynamics. The former is “tame”: neighboring points separate at a polynomial rate, whereas in hyperbolic dynamics they can separate at an exponential rate. Thanks largely to the work of Ratner, the unipotent theory may be said to be largely understood, whereas the hyperbolic theory is in a less satisfactory shape.

The earliest confirmations of Raghunathan’s conjectures for unipotent actions came from the case $d = 2$ with results regarding the horocycle flow which corresponds to the subgroup $\left\{ \begin{pmatrix} 1 & t \\ 0 & 1 \end{pmatrix} \right\}$. The hyperbolic counterpart,

$\left\{ \begin{pmatrix} e^t & 0 \\ 0 & e^{-t} \end{pmatrix} \right\}$, leads to the geodesic flow which is the prototypical example of chaotic dynamics. This would lead one to expect that the higher dimensional cases of diagonal group actions can only get worse, thus leaving little hope for a dynamical approach to the Littlewood conjecture.

Among those who spearheaded the initiative to understand the phenomenon of rigidity in the hyperbolic framework was Anatole Katok, who, in a paper with Ralph Spatzier gave conditions for a rigidity result in the hyperbolic setup. In this paper the importance of the acting group being of rank ≥ 2 is underscored. An analogy is drawn to a phenomenon I have studied; namely the paucity of closed subsets of the group \mathbb{R}/\mathbb{Z} invariant under two endomorphisms $x \rightarrow px \pmod{1}$ and $x \rightarrow qx \pmod{1}$, provided $\{p^n q^m\}$ is not contained in some $\{r^n\}$. (That is to say $\log p / \log q$ is irrational). The only closed sets are \mathbb{R}/\mathbb{Z} itself and finite sets of rationals. It is an open question whether the only invariant measures are correspondingly the obvious ones: Lebesgue measure and atomic measures supported on rational and combinations of these. This example has been instructive for the following reason. Namely if one adds the condition that one or the other transformation, $x \rightarrow px$ or $qx \pmod{1}$ has *positive entropy* with respect to the invariant measure in question, then the measure must have a Lebesgue component. This result of Dan Rudolph which partially answers our query regarding $\times p, \times q$ suggests that for diagonal homogeneous actions, positive entropy will also play a significant role. This is the case already in the paper of Katok and Spatzier where other hypotheses are necessary. The state-of-the-art theorem in this regard is due to Einsiedler, Katok and Lindenstrauss and

it depends heavily on new ideas of Lindenstrauss, requiring only positive entropy along some 1-parameter subgroup to conclude that an invariant measure is of an algebraic character. This theorem provides the crucial step to proving a modified version of Littlewood's conjecture - a version representing the first significant advance on the Littlewood problem: for all but a set of dimension 0 of pairs α, β of real numbers, $\liminf_{n \rightarrow \infty} n \|n\alpha\| \|n\beta\| = 0$.

One of the seminal contributions of Lindenstrauss to this realm is his broadening of the notion of recurrence of a measure to a wide variety of situations, in particular, to situations where the measure is not invariant under a certain set of transformations. Quoting Lindenstrauss, "the only thing which is really needed is some form of recurrence which produces the complicated orbits which are the life and blood of ergodic theory."

This brings us to what is possibly the most exciting work of Elon Lindenstrauss; namely the solution of the Quantum Unique Ergodicity question in the arithmetic case. From the mathematical standpoint the issue is whether eigenfunctions of the Laplace operator on a negatively curved manifold tend to be more and more evenly spread over the space as the eigenvalue tends to negative infinity. In the special case of arithmetic hyperbolic surfaces, the so-called Hecke operators come into the picture and they act on the limiting measure arising from such a sequence of eigenfunctions. This action is recurrent and the tools developed by Lindenstrauss become applicable to this situation at hand, and lead elegantly to a solution of the problem.

Solving the so-called arithmetic quantum unique ergodicity conjecture of Rudnick and Sarnak is exciting if for no other reason than that the conjecture has been established provisionally, based on the generalized Riemann hypothesis. While this doesn't bring us closer to a solution of this famous question, this connection does testify to the depth of the mathematics involved.

I close my introductory remarks by mentioning one of the corollaries of Elon Lindenstrauss's handling of the arithmetic QUE conjecture; namely replacing reals by adèles and integers by rationals, we can speak of the adelic analogue of geodesic flow: namely, the action of the diagonal of $SL_2(\mathbb{A})$ on $SL_2(\mathbb{A})/SL_2(\mathbb{Q})$. The striking statement is that the adelic geodesic flow is uniquely ergodic.

I think it is fair to say that there is both power and beauty in the mathematical work of Elon Lindenstrauss.

Ngô Bao Châu

Studied Mathematics at École Normale Supérieure, Paris, France.

Ph.D., Université de Paris-Sud, Orsay, 1997.

Positions held

Researcher, CNRS, Paris 13 University, 1998-2004.

Professor, Université de Paris-Sud 11, Orsay, 2004- , on leave since 2007.

Member, Institute for Advanced Study, Princeton, 2007-2010.

Professor, University of Chicago, 2010-

The work of Ngô Bao Châu

James Arthur*

Abstract

Ngô Bao Châu has been awarded a Fields Medal for his proof of the fundamental lemma. I shall try to describe the role of the fundamental lemma in the theory of automorphic forms. I hope that this will make it clear why the result will be a cornerstone of the subject. I will also try to give some sense of Ngô's proof. It is a profound and beautiful argument, built on insights mathematicians have contributed for over thirty years.

Mathematics Subject Classification (2000). Primary 11F55; Secondary 14D23.

Keywords. Fundamental lemma, trace formula, Hitchin fibration, affine Springer fibres, stabilization.

The Formal Statement

Here is the statement of Ngô's primary theorem. It is taken from the beginning of the introduction of his paper [N2].

Théorème 1. *Soient k un corps fini à q éléments, \mathcal{O} un anneau de valuation discrète complet de corps résiduel k et F son corps des fractions. Soit G un schéma en groupes réductifs au-dessus de \mathcal{O} dont le nombre de Coxeter multiplié par deux est plus petit que la caractéristique de k . Soient (κ, ρ_κ) une donnée endoscopique de G au-dessus de \mathcal{O} et H le schéma en groupes endoscopiques associé.*

On a l'égalité entre la κ -intégrale orbitale et l'intégrale orbitale stable

$$\Delta_G(a)\mathbf{O}_a^\kappa(1_{\mathfrak{g}}, dt) = \Delta_H(a_H)\mathbf{SO}_{a_H}(1_{\mathfrak{h}}, dt) \quad (1)$$

associées aux classes de conjugaison stable semi-simples régulières a et a_H de

*Department of Mathematics, University of Toronto, Toronto, ON M5S 2E4 Canada.
E-mail: arthur@math.toronto.edu

$\mathfrak{g}(F)$ et $\mathfrak{h}(F)$ qui se correspondent, aux fonctions caractéristiques $1_{\mathfrak{g}}$ et $1_{\mathfrak{h}}$ des compacts $\mathfrak{g}(\mathcal{O})$ et $\mathfrak{h}(\mathcal{O})$ dans $\mathfrak{g}(F)$ et $\mathfrak{h}(F)$ et où on a noté

$$\Delta_G(a) = q^{-\text{val}(\mathfrak{D}_G(a))/2} \text{ et } \Delta_H(a_H) = q^{-\text{val}(\mathfrak{D}_H(a_H))/2}$$

\mathfrak{D}_G and \mathfrak{D}_H étant les fonctions discriminant de G et de H .

In §1.11 of his paper, Ngô describes the various objects of his assertion in precise terms. At this point we simply note that the “orbital integrals” he refers to are integrals of locally constant functions of compact support. The assertion is therefore an identity of sums taken over two finite sets. Observe however that there is one such identity for every pair (a, a_H) of “regular orbits”. As a approaches a singular point, the size of the two finite sets increases without bound, and so therefore does the complexity of the identity. Langlands called it the *fundamental lemma* when he first encountered the problem in the 1970’s. It was clearly fundamental, since he saw that it would be an inescapable precondition for any of the serious applications of the trace formula he had in mind. He called it a lemma because it seemed to be simply a family of combinatorial identities, which would soon be proved. Subsequent developments, which culminated in Ngô’s proof, have revealed it to be much more. The solution draws on some of the deepest ideas in modern algebraic geometry.

Ngô’s theorem is an infinitesimal form of the fundamental lemma, since it applies to the Lie algebras \mathfrak{g} and \mathfrak{h} of the groups G and H . However, Waldspurger had previously used methods of descent to reduce the fundamental lemma for groups to its Lie algebra variant [W3]. Ngô’s geometric methods actually apply only to fields of positive characteristic, but again Waldspurger had earlier shown that it suffices to treat this case [W1].¹ Therefore Ngô’s theorem does imply the fundamental lemma that has preoccupied mathematicians in automorphic forms since it was first conjectured by Langlands in the 1970’s.

I would like to thank Steve Kudla for some helpful suggestions.

Automorphic Forms and the Langlands Programme

To see the importance of the fundamental lemma, we need to recall its place in the theory of automorphic forms. *Automorphic forms* are eigenforms of a commuting family of natural operators attached to reductive algebraic groups. The corresponding eigenvalues are of great arithmetic significance. In fact, the

¹Another proof of this reduction was subsequently established by Cluckers, Hales and Loeser, by completely different methods of motivic integration.

information they contain is believed to represent a unifying force for large parts of number theory and arithmetic geometry. The *Langlands programme* summarizes much of this, in a collection of interlocking conjectures and theorems that govern automorphic forms and their associated eigenvalues. It explains precisely how a theory with roots in harmonic analysis on algebraic groups can characterize some of the deepest objects of arithmetic. There has been substantial progress in the Langlands programme since its origins in a letter from Langlands to Weil in 1967. However, its deepest parts remain elusive.

The operators that act on automorphic forms are differential operators (Laplace-Beltrami operators) and their combinatorial p -adic analogues (Hecke operators). They are best studied implicitly in terms of group representations. One takes G to be a connected reductive algebraic group over a number field F , and R to be the representation of $G(\mathbb{A})$ by right translation on the Hilbert space $L^2(G(F)\backslash G(\mathbb{A}))$. We recall that $G(\mathbb{A})$ is the group of points in G with values in the ring $\mathbb{A} = \mathbb{A}_F$ of adèles of F , a locally compact group in which the diagonal image of $G(F)$ is discrete. Automorphic forms, roughly speaking, are functions on $G(F)\backslash G(\mathbb{A})$ that generate irreducible subrepresentations of R , which are in turn known as *automorphic representations*. Their role is similar to that of the much more elementary functions

$$e^{inx}, \quad n \in \mathbb{Z}, x \in \mathbb{Z} \backslash \mathbb{R},$$

in the theory of Fourier series. We can think of x as a *geometric* variable, which ranges over the underlying domain, and n as a *spectral* variable, whose automorphic analogue contains hidden arithmetic information.

The centre of the Langlands programme is the principle of functoriality. It postulates a reciprocity law for the spectral data in automorphic representations of different groups G and H , for any L -homomorphism $\rho : {}^L H \rightarrow {}^L G$ between their L -groups. We recall that ${}^L G$ is a complex, nonconnected group, whose identity component \widehat{G} can be regarded as a complex dual group of G . There is a special case of this that is of independent interest. It occurs when H is an *endoscopic group* for G , which roughly speaking, means that ρ maps \widehat{H} injectively onto the connected centralizer of a semisimple element of \widehat{G} . The theory of endoscopy, due also to Langlands, is a separate series of conjectures that includes more than just the special case of functoriality. Its primary role is to describe the internal structure of automorphic representations of G in terms of automorphic representations of its smaller endoscopic groups H . The fundamental lemma arises when one tries to use the trace formula to relate the automorphic representations of G with those of its endoscopic groups.²

²Endoscopic groups should actually be replaced by *endoscopic data*, objects with slightly more structure, but I will ignore this point.

The Trace Formula and Transfer

The trace formula for G is an identity that relates spectral data with geometric data. The idea, due to Selberg, is to analyze the operator

$$R(f) = \int_{G(\mathbb{A})} f(y) R(y) dy$$

on $L^2(G(F)\backslash G(\mathbb{A}))$ attached to a variable test function f on $G(\mathbb{A})$. One observes that $R(f)$ is an integral operator, with kernel

$$K(x, y) = \sum_{\gamma \in G(F)} f(x^{-1} \gamma y), \quad x, y \in G(\mathbb{A}).$$

One then tries to obtain an explicit formula by expressing the trace of $R(f)$ as the integral

$$\int_{G(F)\backslash G(\mathbb{A})} \sum_{\gamma \in G(F)} f(x^{-1} \gamma x) dx$$

of the kernel over the diagonal. The formal outcome is an identity

$$\sum_{\{\gamma\}} \int_{G_\gamma(F)\backslash G(\mathbb{A})} f(x^{-1} \gamma x) dx = \sum_{\pi} \text{tr}(\pi(f)), \quad (2)$$

where $\{\gamma\}$ ranges over the conjugacy classes in $G(F)$, $G_\gamma(F)$ is the centralizer of γ in $G(F)$, and π ranges over automorphic representations.

The situation is actually more complicated. Unless $G(F)\backslash G(\mathbb{A})$ is compact, a condition that fails in the most critical cases, $R(f)$ is not of trace class, and neither side converges. One is forced first to truncate the two sides in a consistent way, and then to evaluate the resulting integrals explicitly. It becomes an elaborate process, but one that eventually leads to a rigorous formula with many new terms on each side [A1]. However, the original terms in (2) remain the same in case π occurs in the *discrete* part of the spectral decomposition of R , and γ is *anisotropic* in the strong sense that G_γ is a maximal torus in G with $G_\gamma(F)\backslash G_\gamma(\mathbb{A})$ compact. If γ is anisotropic, and f is a product of functions f_v on the completions $G(F_v)$ of $G(F)$ at valuations v on F , the corresponding integral in (2) can be written

$$\begin{aligned} & \int_{G_\gamma(F)\backslash G(\mathbb{A})} f(x^{-1} \gamma x) dx \\ &= \text{vol}(G_\gamma(F)\backslash G_\gamma(\mathbb{A})) \int_{G_\gamma(\mathbb{A})\backslash G(\mathbb{A})} f(x^{-1} \gamma x) dx \\ &= \text{vol}(G_\gamma(F)\backslash G_\gamma(\mathbb{A})) \prod_v \int_{G_\gamma(F_v)\backslash G(F_v)} f_v(x_v^{-1} \gamma x_v) dx_v. \end{aligned}$$

The factor

$$\mathbf{O}_\gamma(f_v) = \mathbf{O}_\gamma(f_v, dt_v) = \int_{G_\gamma(F_v) \backslash G(F_v)} f_v(x_v^{-1} \gamma x_v) dx_v$$

is the “orbital integral” of f_v over the conjugacy class of γ in $G(F_v)$. It depends on a choice of Haar measure dt_v on $T(F_v) = G_\gamma(F_v)$, as well as the underlying Haar measure dx_v on $G(F_v)$, and makes sense if γ is replaced by any element $\gamma_v \in G(F_v)$ that is *strongly regular*, in the sense that G_{γ_v} is any maximal torus.

The goal is to compare automorphic spectral data on different groups G and H by establishing relations among the geometric terms on the left hand sides of their associated trace formulas. This presupposes the existence of a suitable transfer correspondence $f \rightarrow f^H$ of test functions from $G(\mathbb{A})$ to $H(\mathbb{A})$. The idea here is to define the transfer locally at each completion v by asking that the orbital integrals of f_v^H match those of f_v . Test functions are of course smooth functions of compact support, a condition that for the totally disconnected group $G(F_v)$ at a p -adic place v becomes the requirement that f_v be locally constant and compactly supported. The problem is to show for both real and p -adic places v that f_v^H , defined only in terms of conjugacy classes in $H(F_v)$, really is the family of orbital integrals of a smooth function of compact support on $H(F_v)$.

The transfer of functions is a complex matter, which I have had to oversimplify. It is founded on a corresponding transfer mapping $\gamma_{H,v} \rightarrow \gamma_v$ of strongly regular conjugacy classes over v from any local endoscopic group H for G to G itself. But this only makes sense for *stable* (strongly regular) conjugacy classes, which in the case of G are defined as the intersections of $G(F_v)$ with conjugacy classes in the group $G(\overline{F}_v)$ over an algebraic closure \overline{F}_v . A *stable* orbital integral of f_v is the sum of ordinary orbital integrals over the finite set of conjugacy classes in a stable conjugacy class. Given f_v , H and $\gamma_{H,v}$, Langlands and Shelstad set $\mathbf{SO}_{\gamma_{H,v}}(f_v^H)$ equal to a certain linear combination of orbital integrals of f_v over the finite set of conjugacy classes in the stable image γ_v of $\gamma_{H,v}$. The coefficients are subtle but explicit functions, which they introduce and call transfer factors [LS]. They then conjecture that as the notation suggests, $\{\mathbf{SO}_{\gamma_{H,v}}(f_v^H)\}$ is the set of stable orbital integrals of a smooth, compactly supported function f_v^H on $H(F_v)$.

We can at last say what the fundamental lemma is. For a test function $f = \prod_v f_v$ on $G(\mathbb{A})$ to be *globally* smooth and compactly supported, it must satisfy one further condition. For almost all p -adic places v , f_v must equal the characteristic function 1_{G_v} of an (open) hyperspecial maximal compact subgroup K_v of $G(F_v)$. The fundamental lemma is the natural variant at these places of the Langlands-Shelstad transfer conjecture. It asserts that if f_v equals 1_{G_v} , we can actually take f_v^H to be an associated characteristic function 1_{H_v} on $H(F_v)$. It is in these terms that we understand the identity (1) in Ngô’s theorem. We of course have to replace 1_{G_v} and 1_{H_v} by their analogues $1_{\mathfrak{g}_v}$ and $1_{\mathfrak{h}_v}$ on the Lie algebras $\mathfrak{g}(F_v)$ and $\mathfrak{h}(F_v)$ of $G(F_v)$ and $H(F_v)$, and the mapping

$\gamma_{H,v} \rightarrow \gamma_v$ by a corresponding transfer mapping $a_{H,v} \rightarrow a_v$ of stable adjoint orbits. The superscript κ on the left hand side of (1) is an index that determines an endoscopic group $H = H^\kappa$ for G over F_v by a well defined procedure. It also determines a corresponding linear combination of orbital integrals (called a κ -orbital integral) on $\mathfrak{g}(F_v)$, indexed by the $G(F_v)$ -orbits in the stable orbit a_v . The coefficients depend in a very simple way on κ , and when normalized by the quotient $\Delta_G(\cdot) \Delta_H(\cdot)^{-1}$ of discriminant functions, represent the specialization of the general Langlands-Shelstad transfer factors to the Lie algebra $\mathfrak{g}(F_v)$. The term on the left hand side of (1) is a κ -orbital integral of $1_{\mathfrak{g}_v}$, and the term on the right hand side is a corresponding stable orbital integral of $1_{\mathfrak{h}_v}$.

The Hitchin Fibration

We have observed that local information, in the form of the Langlands-Shelstad transfer conjecture and the fundamental lemma, is a requirement for the comparison of global trace formulas. However, it is sometimes also possible to go in the opposite direction, and to deduce local information from global trace formulas. The most important such result is due to Waldspurger. In 1995, he used a special case of the trace formula to prove that the fundamental lemma implies the Langlands-Shelstad transfer conjecture for p -adic places v [W1]. (The archimedean places v had been treated by local means earlier by Shelstad. See [S].) The fundamental lemma would thus yield the full global transfer mapping $f \rightarrow f^H$. It is indeed fundamental!

Ngô had a wonderful idea for applying global methods to the fundamental lemma itself. He observed that the Hitchin fibration [H], which Hitchin had introduced for the study of the moduli space of vector bundles on a Riemann surface, was related to the geometric side of the trace formula. His idea applies to the field $F = k(X)$ of rational functions on a (smooth, projective) curve X over a finite field of large characteristic. This is a global field, which combines the arithmetic properties of a number field with the geometric properties of the field of meromorphic functions on a Riemann surface, and for which both the trace formula and the Hitchin fibration have meaning. Ngô takes G to be a quasisplit group scheme over X . His version of the Hitchin fibration also depends on a suitable divisor D of large degree on X .

The total space of the Hitchin fibration $\mathcal{M} \rightarrow \mathcal{A}$ is an algebraic (Artin) stack³ \mathcal{M} over k . To any scheme S over k , it attaches the groupoid $\mathcal{M}(S)$ of Higgs pairs (E, ϕ) , where E is a G -torsor over $X \times S$, and $\phi \in H^0(X \times S, \text{Ad}(E) \otimes \mathcal{O}_X(D))$ is a section of the vector bundle $\text{Ad}(E)$ obtained from the adjoint representation of G on its Lie algebra \mathfrak{g} , twisted by the line bundle $\mathcal{O}_X(D)$. Ngô observed that in the case $S = \text{Spec}(k)$, the definitions

³I am little uncomfortable discussing objects in which I do not have much experience. I apologize in advance for any inaccuracies.

lead to a formal identity

$$\sum_{\xi} \left(\sum_{\{a\}} \int_{G_a^{\xi}(F) \backslash G^{\xi}(\mathbb{A})} f_D(\mathrm{Ad}(x)^{-1}a) \, dx \right) = |\{\mathcal{M}(k)\}|, \quad (3)$$

whose right hand side equals the number of isomorphism classes in the groupoid $\mathcal{M}(k)$ [N1, §1]. On the left hand side, ξ ranges over the set $\ker^1(F, G)$ of locally trivial elements in $H^1(F, G)$, a set that frequently equals $\{1\}$, and G^{ξ} is an inner twist of G by ξ , equipped with a trivialization over each local field F_v , with Lie algebra \mathfrak{g}^{ξ} . Also, $\{a\}$ ranges over the $G^{\xi}(F)$ orbits in $\mathfrak{g}^{\xi}(F)$, and $G_a^{\xi}(F)$ is the stabilizer of a in $G^{\xi}(F)$, while

$$f_D = \bigotimes_v f_{D,v},$$

where v ranges over the valuations of F (which is to say the closed points of X) and $f_{D,v}$ is the characteristic function in $\mathfrak{g}^{\xi}(F_v)$ of the open compact subgroup $\varpi_v^{-d_v(D)} \mathfrak{g}^{\xi}(\mathcal{O}_v)$.

The expression in the brackets in (3) is the analogue for the Lie algebra \mathfrak{g}^{ξ} of the left hand geometric side of (2). It is to be regarded in the same way as (2), as part of a formal identity between two sums that both diverge. On the other hand, as in (2), the sum over the subset of orbits $\{a\}$ that are anisotropic actually does converge.

The base \mathcal{A} of the Hitchin fibration is an affine space over k . As a functor, it assigns to any S the set

$$\mathcal{A}(S) = \bigoplus_{i=1}^r H^0(X \times S, \mathcal{O}_X(e_i D)),$$

where e_1, \dots, e_r are the degrees of the generators of the polynomial algebra of G -invariant polynomials on \mathfrak{g} . Roughly speaking, the set $\mathcal{A}(k)$ attached to $S = \mathrm{Spec}(k)$ parametrizes the stable $G(\mathbb{A})$ -orbits in $\mathfrak{g}(\mathbb{A})$ that have representatives in $\mathfrak{g}(F)$, and intersect the support of the function f_D . The Chevalley mapping from \mathfrak{g} to its affine quotient \mathfrak{g}/G determines a morphism h from \mathcal{M} to \mathcal{A} over k . This is the Hitchin fibration. Ngô uses it to isolate the orbital integrals that occur on the left hand side of (3). In particular, he works with the open subscheme $\mathcal{A}^{\mathrm{ani}}$ of \mathcal{A} that represents orbits that are anisotropic over \bar{k} . The restriction

$$h^{\mathrm{ani}} : \mathcal{M}^{\mathrm{ani}} \longrightarrow \mathcal{A}^{\mathrm{ani}}, \quad \mathcal{M}^{\mathrm{ani}} = h^{-1}(\mathcal{A}^{\mathrm{ani}}) = \mathcal{M} \times_{\mathcal{A}} \mathcal{A}^{\mathrm{ani}}, \quad (4)$$

of the morphism h to $\mathcal{A}^{\mathrm{ani}}$ is then proper and smooth, a reflection of the fact that the stabilizer in G of any anisotropic point $a \in \mathfrak{g}(F)$ is an anisotropic torus over the maximal unramified extension of F . (See [N2, §4].)

Affine Springer Fibres

The Hitchin fibration can be regarded as a “geometrization” of a part of the global trace formula. It opens the door to some of the most powerful techniques of algebraic geometry. Ngô uses it in conjunction with another geometrization, which had been introduced earlier, and applies to the fibres \mathcal{M}_a of the Hitchin fibration. This is the interpretation of the local orbital integral

$$\mathbf{O}_{\gamma_v}(\mathbf{1}_{\mathfrak{g}_v}) = \int_{G_{a_v}(F_v) \backslash G(F_v)} \mathbf{1}_{\mathfrak{g}_v}(\mathrm{Ad}(x_v)^{-1} a_v) dx_v$$

in terms of affine Springer fibres.

The original Springer fibre of a nilpotent element N in a complex semisimple Lie algebra is the variety of Borel subalgebras (or more generally, of parabolic subalgebras in a given adjoint orbit under the associated group) that contain N . It was used by Springer to classify irreducible representations of Weyl groups. The affine Springer fibre of a topologically unipotent (regular, semisimple) element $a_v \in \mathfrak{g}(F_v)$, relative to the adjoint orbit of the lattice $\mathfrak{g}(\mathcal{O}_v)$, is the set

$$\mathcal{M}_v(a, k) = \{x_v \in G(F_v)/G(\mathcal{O}_v) : \mathrm{Ad}(x_v)^{-1} a_v \in \mathfrak{g}(\mathcal{O}_v)\}$$

of lattices in the orbit that contain a_v . Suppose for example that a_v is anisotropic over F_v , in the strong sense that the centralizer $G_{a_v}(F_v)$ is compact. If one takes the compact (abelian) groups $G_{a_v}(F_v)$ and $\mathfrak{g}(\mathcal{O}_v)$ to have Haar measure 1, one sees immediately that $\mathbf{O}_{a_v}(\mathbf{1}_{\mathfrak{g}_v})$ equals the order $|\mathcal{M}_v(a, k)|$ of $\mathcal{M}_v(a, k)$. (Topologically unipotent means that the linear operator $\mathrm{ad}(a_v)^n$ on $\mathfrak{g}(F_v)$ approaches 0 as n approaches infinity. In general, the closer a_v is to 0, the larger is the set $\mathcal{M}_v(a, k)$, and the more complex the orbital integral $\mathbf{O}_{a_v}(\mathbf{1}_{\mathfrak{g}_v})$.)

Kazhdan and Lusztig introduced affine Springer fibres in 1988, and established some of their geometric properties [KL]. In particular, they proved that $\mathcal{M}_v(a, k)$ is the set of k -points of an inductive limit $\mathcal{M}_v(a)$ of schemes over k . (It is this ind-scheme that is really called the affine Springer fibre.) Their results also imply that if a_v is anisotropic over the maximal unramified extension of F_v , $\mathcal{M}_v(a)$ is in fact a scheme.

The study of these objects was then taken up by Goresky, Kottwitz and MacPherson. Their strategy was to obtain information about the orbital integral $|\mathcal{M}_v(a, k)|$ from some version of the Lefschetz fixed point formula. They realized that relations among orbital integrals could sometimes be extracted from cohomology groups of affine Springer fibres $\mathcal{M}_v(a)$ and $\mathcal{M}_v(a_H)$, for the two different groups G and H . Following this strategy, they were able to establish the identity (1) for certain pairs $(a_v, a_{H,v})$ attached to unramified maximal tori [GKM]. Goresky, Kottwitz and MacPherson actually worked with certain equivariant cohomology groups. Laumon and Ngô later added a deformation argument, which allowed them to prove the fundamental lemma for unitary

groups [LN]. However, the equivariant cohomology groups that led to these results are not available in general.

It was Ngô's introduction of the global Hitchin fibration that broke the impasse. He formulated the affine Springer fibre $\mathcal{M}_v(a)$ as a functor of schemes S over k , in order that it be compatible with the relevant Hitchin fibre \mathcal{M}_a [N2, §3.2]. He also introduced a third object to mediate between the two kinds of fibre. It is a Picard stack $\mathcal{P} \rightarrow \mathcal{A}$, which acts on \mathcal{M} , and represents the natural symmetries of the Hitchin fibration. Ngô attached this object to the group scheme J over \mathcal{A} obtained from the G -centralizers of regular elements in \mathfrak{g} , and the Kostant section from semisimple conjugacy classes to regular elements.

The stack \mathcal{P} plays a critical role. Ngô used it to formulate the precise relation between the Hitchin fibre \mathcal{M}_a at any $a \in \mathcal{A}^{\text{ani}}(\bar{k})$ with the relevant affine Springer fibres $\mathcal{M}_v(a)$ [N2, Proposition 4.15.1]. Perhaps more surprising is the fact that as a group object in the category of stacks, \mathcal{P} governs the stabilization of anisotropic Hitchin fibres \mathcal{M}_a . Ngô analyses the characters $\{\kappa\}$ on the abelian groups of connected components $\pi_0(\mathcal{P}_a)$. He shows that they are essentially the geometric analogues of objects that were used to stabilize the anisotropic part of the trace formula.

Stabilization

Could one possibly establish the fundamental lemma from the trace formula? Any such attempts have always foundered on the lack of a transfer of unit functions 1_{G_v} to 1_{H_v} by orbital integrals. In some sense, however, this is exactly what Ngô does. It is not the trace formula for automorphic forms that he uses, but the Grothendieck-Lefschetz trace formula of algebraic geometry. Moreover, it is the “spectral” side of this trace formula that he transfers from \mathfrak{g} to \mathfrak{h} (the Lie algebras of G and H), in the form of data from cohomology, rather than its “geometric” side, in the form of data given by fixed points of Frobenius endomorphisms. This is in keeping with the general strategy of Goresky, Kottwitz and MacPherson. The difference here is that Ngô begins with perverse cohomology attached to the global Hitchin fibration, rather than the ordinary equivariant cohomology of a local affine Springer fibre.

Stabilization refers to the operation of writing the trace formula for G , or rather each of its terms $I(f)$, as a linear combination

$$I(f) = \sum_H \iota(G, H) S^H(f^H) \quad (5)$$

of stable distributions on the endoscopic groups H of G over F . (A stable distribution is a linear form whose values depend only on the stable orbital integrals of the given test function. The resulting identity of stable distributions for any given H , obtained by induction on $\dim(H)$ from (5) and the trace

formula for G , is known as the stable trace formula.) The process is most transparent for the anisotropic terms⁴

$$I^{\text{ani}}(f) = \sum_{\{\gamma\}} \text{vol}(G_\gamma(F) \backslash G_\gamma(\mathbb{A})) \cdot \prod_v (\mathbf{O}_\gamma(f_v)), \quad (6)$$

in which $\{\gamma\}$ ranges over the set of anisotropic conjugacy classes in $G(F)$. It was carried out in this case by Langlands [L] and Kottwitz [K2], assuming the existence of the global transfer mapping $f \rightarrow f^H$ (which Waldspurger later reduced to the fundamental lemma). This is reviewed by Ngô in the first chapter (§1.13) of his paper [N2].

The idea for the stabilization of (6) can be described very roughly as follows. One first groups the conjugacy classes $\{\gamma\}$ into stable conjugacy classes $\{\gamma\}_{\text{st}}$ in $G(F)$, for representatives γ attached to anisotropic tori $T = G_\gamma$. The problem is to quantify the obstruction for the contribution of $\{\gamma\}_{\text{st}}$ to be a stable distribution on $G(\mathbb{A})$. For any v , the set of $G(F_v)$ -conjugacy classes in the stable conjugacy class of γ in $G(F_v)$ is bijective with the set

$$\ker(H^1(F_v, G) \rightarrow H^1(F_v, T))$$

of elements in the finite abelian group $H^1(F_v, T)$ whose image in the Galois cohomology set $H^1(F_v, G)$ is trivial. Let me assume for simplicity in this description that G is simply connected. The set $H^1(F_v, G)$ is then trivial for any p -adic place v , and becomes a concern only when v is archimedean. The obstruction for $\{\gamma\}_{\text{st}}$ is thus closely related to the abelian group

$$\text{coker} \left(H^1(F, T) \rightarrow \bigoplus_v H^1(F_v, T) \right).$$

The next step is to apply Fourier inversion to this last group. According to Tate-Nakayama duality theory, its dual group of characters κ is isomorphic to \widehat{T}^Γ , the group of elements in the complex dual torus \widehat{T} that are invariant under the natural action of the global Galois group $\Gamma = \text{Gal}(\overline{F}/F)$. On the other hand, each $\kappa \in \widehat{T}^\Gamma$ maps to a semisimple element in the complex dual group \widehat{G} , which can be used to define an endoscopic group $H = H^\kappa$ for G . One accounts for the local archimedean sets $H^1(F_v, G)$ simply by defining the local contribution of a complementary element in $H^1(F_v, T)$ to be 0. In this way, one obtains a global contribution to (6) for any κ . It is a global κ -orbital integral, whose local factor at almost any v appears on the left hand side of the identity in the fundamental lemma.

One completes the stabilization of (6) by grouping the indices (T, κ) into equivalence classes that map to a given H . The corresponding contributions to

⁴This expression only makes sense if the split component A_G of G is trivial. In general, one must include A_G in the volume factors.

the right hand side of (6) become the summands of H in (5). Notice that the summands with $\kappa = 1$ correspond to the endoscopic group H with $\widehat{H} = \widehat{G}$ (a quasisplit inner form G^* of G). Like all of the other summands, they are defined directly. This is in contrast to the more exotic parts $I(f)$ of the trace formula [A1, §29], where the contribution of $H = G^*$ (known as the stable part $I_{\text{st}}(f)$ of $I(f)$ in case $G = G^*$ is already quasisplit) can only be constructed from (5) indirectly by induction on $\dim(H)$.

The heart of Ngô's proof is an analogue of the stabilization of (6) for the geometrically anisotropic part (4) of the Hitchin fibration.⁵ This does not depend on the transfer of functions, and is therefore unconditional. Ngô formulates it as an identity of the $\{\kappa\}$ -component $(\cdot)_\kappa$ of an object attached to G with the stable component $(\cdot)_{\text{st}}$ of a similar object for the corresponding endoscopic group. I will only be able to describe his steps in the most general of terms.

Since \mathcal{M}^{ani} is a smooth Deligne-Mumford stack, the purity theorems of [D] and [BBD] can be applied to the proper morphism h^{ani} in (4). They yield an isomorphism

$$h_*^{\text{ani}} \overline{\mathbb{Q}}_\ell \cong \bigoplus_n {}^p H^n (h_*^{\text{ani}} \overline{\mathbb{Q}}_\ell) [-n], \tag{7}$$

whose left hand side is a priori only an object in the derived category $D_c^b(\mathcal{A})$ of the bounded complexes of sheaves on \mathcal{A} with constructible cohomology, but whose right hand summands are pure objects in the more manageable abelian subcategory of perverse sheaves on \mathcal{A} . Ngô then considers the action of the stack \mathcal{P}^{ani} over \mathcal{A}^{ani} on either side. Appealing to a homotopy argument, he observes that this action factors through the quotient $\pi_0(\mathcal{P}^{\text{ani}})$ of connected components, a sheaf of finite abelian groups on \mathcal{A}^{ani} . As we noted earlier, an analysis of this sheaf then leads him to the dual characters $\{\kappa\}$ that were part of the stabilization of (6), and relative to which one can take equivariant components ${}^p H^n (f_*^{\text{ani}} \overline{\mathbb{Q}}_\ell)_\kappa$ of the summands in (7). On the other hand, if H corresponds to κ , we have the morphism ν from \mathcal{A}_H to \mathcal{A} that comes from the embedding $\widehat{H} \subset \widehat{G}$ of two dual groups of equal rank. It provides a pullback mapping of sheaves from \mathcal{A} to \mathcal{A}_H . Ngô's stabilization of (4) then takes the form of an isomorphism

$$\nu^* \left(\bigoplus_n {}^p H^n (h_*^{\text{ani}} \overline{\mathbb{Q}})_\kappa [2r] (r) \right) \cong \bigoplus_n {}^p H^n (h_{H,*}^{\text{ani}} \overline{\mathbb{Q}}_\ell)_{\text{st}}, \tag{8}$$

for a degree shift $[2r]$ and Tate twist (r) attached to a certain positive integer $r = r_H^G(D)$. (See [N2, Theorem 6.4.2].)

⁵Recall that the left hand side of (3) differs from that of (2) in having a supplementary sum over $\xi \in \ker^1(F, G)$. This is part of the structure of the Hitchin fibration. But it also actually leads to a slight simplification of the stabilization of (6) by Langlands and Kottwitz. (See [N2, §1.13].)

Ngô's "geometric stabilization" identity (8), whose statement I have oversimplified slightly,⁶ is a key theorem. In particular, it leads directly to the fundamental lemma. For it implies a similar identity for the stalks of the sheaves at a point $a_H \in \mathcal{A}_H$ (with image $a \in \mathcal{A}$ under ν). After some further analysis, the application of a theorem of proper base change reduces what is left to an endoscopic identity for the cohomology of affine Springer fibres. This is exactly what Goresky, Kottwitz and MacPherson had been working towards. Once it is available, an application of the Grothendieck-Lefschetz trace formula gives a relation among points on affine Springer fibres, which leads to the fundamental lemma. (See [LN, §3.10] for example.)

However, it is more accurate to say that the (global) stabilization identity (8) is *parallel* to the (local) fundamental lemma. Ngô actually had to prove the two theorems together. In a series of steps, which alternate between local and global arguments, and go back and forth between the two theorems, he treats special cases that become increasingly more general, until the proof of both theorems is at last complete. Everything of course depends on the original divisor D on X , which in Ngô's argument is allowed to vary in such a way that its degree approaches infinity. The main technical result that goes into the proof of (8) is a theorem on the support of the sheaves on the left hand side. As I understand it, this is highly dependent on the fact that these objects are actually perverse sheaves.

Further Remarks

I should also mention two important generalizations of the fundamental lemma. One is the "twisted fundamental lemma" conjectured by Kottwitz and Shelstad, which will be needed for any endoscopic comparison that includes the twisted trace formula. Waldspurger [W3] had reduced this conjecture to the primary theorem of Ngô, together with a variant [N2, Théorème 2] of (1) that Ngô proves by the same methods. Another is the "weighted fundamental lemma", which applies to the more general geometric terms in the trace formula that are obtained by truncation. It is needed for any endoscopic comparisons that do not impose unsatisfactory local constraints on the automorphic representations. Once again, Waldspurger had reduced the conjectural identity to its analogue for a Lie algebra over a local field of positive characteristic. Chaudouard and Laumon have recently proved the weighted fundamental lemma for Lie algebras by extending the methods of Ngô to other terms in the trace formula [CL]. This has been a serious enterprise, which requires a geometrization of analytic truncation methods in order to deal with the failure of the full Hitchin fibration $\mathcal{M} \rightarrow \mathcal{A}$ to be proper. In any case, all forms of the fundamental lemma have

⁶The isomorphism is between the semisimplifications of the graded perverse sheaves. Moreover, ν , h^{ani} and h_H^{ani} should be replaced by their preimages $\tilde{\nu}$, h^{ani} and \tilde{h}_H^{ani} relative to certain finite morphisms.

now been proved, including the most general “twisted, weighted fundamental lemma”.

I have emphasized the role of transfer in the comparison of trace formulas. This is likely to lead to a classification of automorphic representations for many groups G , beginning with orthogonal and symplectic groups [A2], according to Langlands’ conjectural theory of endoscopy. The fundamental lemma also has other important applications. For example, its proof fills a longstanding gap in the theory of Shimura varieties. Kottwitz observed some years ago that the key geometric terms in the Grothendieck-Lefschetz formula for a Shimura variety are actually twisted orbital integrals [K1]. The twisted fundamental lemma now allows a comparison of these terms with corresponding terms in the stable trace formula. (See [K3].) This in turn leads to reciprocity laws between the arithmetic data in the cohomology of many such varieties with the spectral data in automorphic forms.

This completes my report. It will be clear that Ngô’s proof is deep and difficult. What may be less clear is the enormous scope of his methods. The many diverse geometric objects he introduces are all completely natural. That they so closely reflect objects from the trace formula and local harmonic analysis, and fit together so beautifully in Ngô’s proof, is truly remarkable.

References

- [A1] J. Arthur, *An introduction to the trace formula*, in *Harmonic Analysis, the Trace Formula, and Shimura Varieties*, Clay Mathematics Proceedings, vol. 4, 2005, 1–263.
- [A2] J. Arthur, *The Endoscopic Classification of Representations: Orthogonal and Symplectic Groups*, in preparation.
- [BBD] A. Beilinson, J. Bernstein and P. Deligne, *Faisceaux pervers*, Astérisque **100** (1982).
- [CL] P.-H. Chaudouard and G. Laumon, *Le lemme fondamental pondéré II: Énoncés cohomologiques*, preprint.
- [D] P. Deligne, *La conjecture de Weil II*, Publ. Math. de I.H.E.S. **52** (1980), 137–252.
- [GKM] M. Goresky, R. Kottwitz, and R. MacPherson, *Homology of affine Springer fibres in the unramified case*, Duke Math. J. **121** (2004), 509–561.
- [H] N. Hitchin, *Stable bundles and integrable connections*, Duke Math. J. **54** (1987), 91–114.
- [KL] D. Kazhdan and G. Lusztig, *Fixed point varieties on affine flag manifolds*, Israel J. Math. **62** (1988), 129–168.
- [K1] R. Kottwitz, *Shimura varieties and twisted orbital integrals*, Math. Ann. **269** (1984), 287–300.
- [K2] R. Kottwitz, *Stable trace formula: elliptic singular terms*, Math. Ann. **275** (1986), 365–399.

-
- [K3] R. Kottwitz, *Shimura varieties and λ -adic representations*, in *Automorphic Forms, Shimura Varieties and L-functions*, vol. I, Academic Press, 1990, 161–209.
- [L] R. Langlands, *Les débuts d'une formule des traces stables*, Publ. Math. Univ. Paris VII **13**, 1983.
- [LS] R. Langlands and D. Shelstad, *On the definition of transfer factors*, Math. Ann. **278** (1987), 219–271.
- [LN] G. Laumon and B.C. Ngô, *Le lemme fondamental pour les groupes unitaires*, Annals of Math. **168** (2008), 477–573.
- [N1] B.C. Ngô, *Fibration de Hitchin et endoscopie*, Invent. Math. **164** (2006), 399–453.
- [N2] B.C. Ngô, *Le lemme fondamental pour les algèbres de Lie*, Publ. Math. I.H.E.S. **111** (2010), 1–169.
- [S] D. Shelstad, *Tempered endoscopy for real groups I: geometric transfer with canonical factors*, Contemp. Math. **472** (2008), 215–246.
- [W1] J.-L. Waldspurger, *Le lemme fondamental implique le transfer*, Compositio Math. **105** (1997), 153–236.
- [W2] J.-L. Waldspurger, *Endoscopie et changement de caractéristique*, J. Inst. Math. Jussieu **5** (2006), 423–525.
- [W3] J.-L. Waldspurger, *L'endoscopie tordue n'est pas si tordue*, Memoirs of AMS **908** (2008).

Contents

Preface	v
Past Congresses	1
Organisation of the Congress	3
Committees	10
Opening Ceremony, 19 August 2010	20
Closing Ceremony, 27 August 2010	38
The work of winners of the Fields Medal, the Nevanlinna, the Gauss and the Chern Prizes	49
Harry Furstenberg The work of Elon Lindenstrauss	51
James Arthur The work of Ngô Bao Châu	57
Harry Kesten The work of Stanislav Smirnov	73
Hong-Tzer Yau The work of Cédric Villani	87
Gil Kalai The work of Daniel A. Spielman	101
Ingrid Daubechies The work of Yves Meyer	115
YanYan Li The work of Louis Nirenberg	127
Plenary Lectures	
David J. Aldous Exchangeability and Continuum Limits of Discrete Random Structures ..	141
Artur Avila Dynamics of Renormalization Operators	154

R. Balasubramanian	
Highly Composite.....	176
Ngô Bao Châu	
Endoscopy Theory of Automorphic Forms.....	210
Jean-Michel Coron	
On the Controllability of Nonlinear Partial Differential Equations.....	238
Irit Dinur	
Probabilistically Checkable Proofs and Codes.....	265
Hillel Furstenberg	
Ergodic Structures and Non-conventional Ergodic Theorems.....	286
Thomas J.R. Hughes	
Isogeometric Analysis.....	299
Carlos E. Kenig	
Recent Developments on the Global Behavior to Critical Nonlinear Dispersive Equations.....	326
R. Parimala	
Arithmetic of Linear Algebraic Groups over Two-dimensional Fields.....	339
A.N. Parshin	
Representations of Higher Adelic Groups and Arithmetic.....	362
Shige Peng	
Backward Stochastic Differential Equation, Nonlinear Expectation and Their Applications.....	393
Kim Plofker	
“Indian” Rules, “Yavana” Rules: Foreign Identity and the Transmission of Mathematics.....	433
Richard Schoen	
Riemannian Manifolds of Positive Curvature.....	449
Claire Voisin	
On the Cohomology of Algebraic Varieties.....	476
W. Hugh Woodin	
Strong Axioms of Infinity and the Search for V	504
 Special Lectures	
Elon Lindenstrauss (<i>Fields Medal</i>)	
Equidistribution in Homogeneous Spaces and Number Theory.....	531
Idun Reiten (<i>Emmy Noether Lecture</i>)	
Cluster Categories.....	558
Stanislav Smirnov (<i>Fields Medal</i>)	
Discrete Complex Analysis and Probability.....	595

S.R.S. Varadhan (<i>Abel Lecture</i>)	
Large Deviations	622
Cédric Villani (<i>Fields Medal</i>)	
Landau Damping	640
Special Activities	
W.T. Gowers	
A Continuous Path from School Calculus to University Analysis	657
Carlos Bosch	
Relations between the Discipline and the School Mathematics in Latin American and Caribbean Countries	662
R. Ramanujam	
Live Mathematics and Classroom Processes	668
Heinz Steinbring	
Mathematical Knowledge in Processes of Teaching and Learning at School - Its Specific Nature and Epistemological Status	680
Ole Skovsmose	
Symbolic Power and Mathematics	690
Günter M. Ziegler	
Communicating Mathematics to Society at Large	706
Christiane Rousseau	
The Role of Mathematicians in Popularization of Mathematics	723
J. M. Ball	
Round Table: The Use of Metrics in Evaluating Research	739
Stephen Huggett	
Mechanisms for Strengthening Mathematics in Developing Countries	757
Other Activities	767
List of Participants	769
Author Index for Volumes II, III, and IV	799
Author Index for Volume I	803

Stanislav Smirnov

Graduation from St. Petersburg State University, 1992;

Ph.D., California Institute of Technology, 1996.

Positions held

Gibbs Instructor at the Yale University, 1996-1999;

short-term positions at MPI Bonn and IAS Princeton, 1997-1998;

Researcher at the Royal Institute of Technology in Stockholm, 1998-2001;

Professor at the Royal Institute of Technology in Stockholm, from 2001;

Researcher at the Swedish Royal Academy of Sciences 2001-2004;

Professor at the University of Geneva, 2003-.

The work of Stanislav Smirnov

Harry Kesten*

Mathematics Subject Classification (2000). 60F05; 60K35

Keywords. Fields medal, Conformal Invariance, Cardy's formula, crossing probabilities

Stanislav (Stas for short) Smirnov is receiving a Fields medal for his ingenious and astonishing work on the existence and conformal invariance of scaling limits or continuum limits of lattice models in statistical physics.

Like many Fields medalists, Stas demonstrated his mathematical skills at an early age. According to Wikipedia he was born on Sept 3, 1970 and was ranked first in the 1986 and 1987 International Mathematical Olympiads. He was an undergraduate at Saint Petersburg State University and obtained his Ph.D. at Caltech in 1996 with Nikolai Makarov as his thesis advisor. Stas has also worked on complex analysis and dynamical systems, but in these notes we shall only discuss his work on limits of lattice models. This work should make statistical physicists happy because it confirms rigorously what so far was only accepted on heuristic grounds. The success of Stas in analyzing lattice models in statistical physics will undoubtedly be a stimulus for further work.

Before I start on the work for which Stas is best known, let me mention a wonderful result of his (together with Hugo Duminil-Copin, [21]) which he announced only two months ago. They succeeded in rigorously verifying that the connective constant of the planar hexagonal lattice is $\sqrt{2+\sqrt{2}}$. The *connective constant* μ of a lattice \mathcal{L} is defined as $\lim_{n \rightarrow \infty} [c_n]^{1/n}$, where c_n is the number of self-avoiding paths on \mathcal{L} of length n which start at a fixed vertex v . It is usually easy to show by subadditivity (or better submultiplicativity; $c_{n+m} \leq c_n c_m$) that this limit exists and is independent of the choice of v . However, the value of μ is unknown for most \mathcal{L} . Thus this result of Stas is another major success in Statistical Physics.

*Malott Hall, Cornell University, Ithaca, NY., 14853, USA.
E-mail: kesten@math.cornell.edu

1. Percolation

Since the result for which Stas is best known deals with percolation, it is appropriate to describe this model first. The first percolation problem appeared in Amer. Math Monthly, vol. 1 (1894), proposed by M.A.C.E. De Volson Wood ([9]). He proposes the following problem: “An equal number of white and black balls of equal size are thrown into a rectangular box, what is the probability that there will be contiguous contact of white balls from one end of the box to the opposite end? “As a special example, suppose there are 30 balls in the length of the box, 10 in the width, and 5 (or 10) layers deep.” Apart from an incorrect solution by one person who misunderstands the problem, there is no reaction and we still have no answer. Next there is a hiatus of almost 60 years to 1954 when Broadbent ([1]) asks Hammersley at a symposium on Monte-Carlo methods a question which I interpret as follows: Think of the edges of \mathbb{Z}^d as tubes through which fluid can flow with probability p and are blocked with probability $1 - p$. Alternatively we assign the color blue or yellow to the edges or call the edges occupied or vacant.) p is the same for all edges, and the edges are independent of each other. If fluid is pumped in at the origin, how far can it spread? Can it reach infinity? Physicists are interested in the model since it seems to be one of the simplest models which has a phase transition. In fact Broadbent and Hammersley ([1, 2]) proved that there exists a value p_c , strictly between 0 and 1, such that ∞ is reached with probability 0 when $p < p_c$, but can be reached with strictly positive probability for $p > p_c$. p_c is called the *critical probability*. The *percolation probability* $\theta(p)$ is defined as the probability that infinity is reached from the origin (or from any other fixed vertex).

Let E be a set of edges. Say that a point a is *connected* (in E) to a point b if there is an open path (in E) from a to b . One can then define the *open clusters* as maximal connected components of open edges in E . By translation invariance, the Broadbent and Hammersley result shows that on \mathbb{Z}^d , for $p < p_c$, with probability 1 all open clusters are finite, while it can be shown for $p > p_c$, that with probability 1 there exists a unique infinite open cluster (see [3] for uniqueness). We can do the same thing when we replace \mathbb{Z}^d by another lattice. We can also have all edges open, but the vertices open with probability p and closed with probability $1 - p$. In obvious terminology we talk about bond and site percolation. Site percolation is more general than bond percolation, in the sense that any bond percolation model is equivalent to a site percolation model on another graph, but not vice versa. For Stas’ brilliant result we shall consider exclusively site percolation on the 2-dimensional triangular lattice. See Figure 1.

We would like to have a global (as opposed to microscopic) description of such systems. Can we tell what $\theta(p, \mathcal{L})$ is? And similarly, what is the behavior of the “average cluster size” and some other functions. We have a fair understanding of the system for $p \neq p_c$ fixed. For instance, if $p < p_c$, then (with probability 1) there is a translation invariant system of finite clusters, and the probability that the volume of the cluster of a fixed site exceeds n decreases

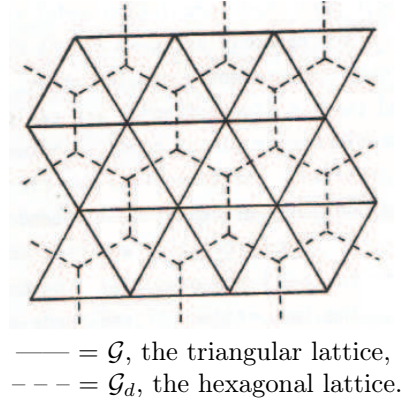

Figure 1.

exponentially in n (see [10], Theorem 6.75). If $p > p_c$, then there is exactly one infinite open cluster. Also, if \mathcal{C} denotes the open cluster of the origin, then for some constants $0 < c_1(p) \leq c_2(p) < \infty$,

$$c_1 n^{(d-1)/d} \leq -\log [P_p\{|\mathcal{C}| = n\}] \leq c_2 n^{(d-1)/d}.$$

For $d = 2$ we even know that

$$0 < -\lim_{n \rightarrow \infty} n^{-(d-1)/d} \log [P_p\{|\mathcal{C}| = n\}] < \infty,$$

i.e., for some $0 < c(p) < \infty$,

$$P_p\{|\mathcal{C}| = n\} = \exp [-(c + o(1))n^{(d-1)/d}]$$

(see [10], Section 8.6). For these reasons the most interesting behavior can be expected to be for p equal or close to p_c . We have here a system with a function $\theta(p, \mathcal{L})$, which has a phase transition, but, at least in dimension 2, is continuous. I am told that physicists have been successful in analyzing such systems by making an extra assumption, the so-called *scaling hypothesis*: for $p \neq p_c$ there is a single length scale $\xi(p)$, called the *correlation length*, such that for p close to p_c , at distance n the picture of the system looks like a single function of $n/\xi(p)$. More explicitly, it is assumed that many quantities behave like $T(n/\xi(p))$ for some function T which is the same for a class of lattices \mathcal{L} . What happens when $p = p_c$ where there is no special length scale singled out (other than the lattice spacing)? The correlation length is assumed to go to ∞ as $p \rightarrow p_c$. Therefore, investigating what happens as $p \rightarrow p_c$ automatically entails looking at a piece of our system which is many lattice spacings large. For convenience we shall think of looking at our system in a fixed piece of space, but letting the lattice spacing go to 0. We shall call this “taking the scaling limit” or “taking the continuum limit.” We shall try to explain Stas’ result that this limit exists and is conformally invariant if we consider critical site percolation on the triangular lattice in the plane.

2. The Scaling Limit

What do we expect or hope for? One hopes that at least the cluster distribution and the distribution of the curves separating two adjacent clusters converge in some sense in the scaling limit. Since there is no special scale, one expects scale invariance of the limit. If \mathcal{L} has enough symmetry you can also hope for rotational symmetry of the scaling limit. In dimension two, scale and rotation invariance together should give invariance under holomorphic transformations. If one believes in scale invariance, then one can expect power laws, i.e., that certain functions behave like a power of n or $|p - p_c|$ for n large or p close to p_c . E.g., if we set $R = R(p)$ = the radius of the open cluster of the origin, then scale invariance at $p = p_c$ would give that

$$\frac{P_{p_c}\{R \geq xy\}}{P_{p_c}\{R \geq y\}} \rightarrow g(x) \quad (2.1)$$

for some function $g(x)$, as $y \rightarrow \infty$ and $x \geq 1$ fixed. This, in turn, would imply $g(xy) = g(x)g(y)$ and $g(x) = x^\lambda$ for some constant λ . Necessarily $\lambda \leq 0$, since (2.1) is less than or equal to 1 for $x \geq 1$. Now let $\varepsilon > 0$ and $(1 + \varepsilon)^k \leq t \leq (1 + \varepsilon)^{k+1}$. Then

$$P_{p_c}\{R \geq t\} \leq P_{p_c}\{R \geq (1 + \varepsilon)^k\} = P_{p_c}\{R \geq 1\} \prod_{j=1}^k \frac{P_{p_c}\{R \geq (1 + \varepsilon)^j\}}{P_{p_c}\{R \geq (1 + \varepsilon)^{(j-1)}\}}. \quad (2.2)$$

Since

$$\frac{P_{p_c}\{R \geq (1 + \varepsilon)^j\}}{P_{p_c}\{R \geq (1 + \varepsilon)^{(j-1)}\}} \rightarrow g(1 + \varepsilon) = (1 + \varepsilon)^\lambda \text{ as } j \rightarrow \infty,$$

we obtain

$$P_{p_c}\{R \geq t\} \leq t^{\lambda+o(1)} \text{ as } t \rightarrow \infty.$$

By replacing k by $k + 1$ and reversing the inequality in the lines following (2.2) we see that

$$P_{p_c}\{R \geq t\} = t^{\lambda+o(1)} \text{ as } t \rightarrow \infty \text{ or } \lim_{t \rightarrow \infty} \frac{\log P_{p_c}\{R \geq t\}}{\log t} = \lambda. \quad (2.3)$$

Of course we did not prove (2.1) here, nor did we obtain information about λ . The complete proof of (2.3) and evaluation of λ in [15] is much more intricate.

An example of a different but related kind of power law which one may expect says

$$\frac{\log [\theta(p)]}{\log(p - p_c)} \rightarrow \beta \text{ as } p \downarrow p_c.$$

Exponents such as λ and β are called *critical exponents*. It is believed that all these exponents can be obtained as algebraic functions of only a small number of independent exponents. Physicists have indeed found (non-rigorously) that

various quantities behave as powers. Still on a heuristic basis, they believe that these exponents are *universal*, in the sense that they depend basically on the dimension of the lattice only. In particular they should exist and be the same for the bond and site version on \mathbb{Z}^2 and the bond and site version on the triangular lattice. For the planar lattices physicists even predicted values for these exponents.

The pathbreaking work of Stas and Lawler, Schramm, Werner has made it possible to prove some power laws for various processes such as site percolation on the triangular lattice, loop erased random walk, or processes related to the uniform spanning tree. Nevertheless, there still is no proof of universality for percolation, because the percolation results so far are for one lattice only, namely site percolation on the triangular lattice. As stated by Stas in his lecture at the last ICM ([20], p. 1421), “The point which is perhaps still less understood both from mathematics and physics points of view is why there exists a universal conformally equivalent scaling limit.” *From now on, all further results tacitly assume that we are dealing with site percolation on the triangular lattice.* As far as I know no other two dimensional percolation results have been proven. For this lattice p_c equals $1/2$.

Somehow, the knowledge and guesses about other similar systems convinced people that it would be helpful to prove that the scaling limit for percolation at p_c in two dimensions exists and is conformally invariant. This is still vague since we did not specify what it means that the scaling limit exists and is conformally invariant. It seems that M. Aizenman (see [13], bottom of p. 556) was the first to express this as a requirement about the scaling limit of *crossing probabilities*.

A crossing probability of a Jordan domain \mathcal{D} with boundary the Jordan curve $\partial\mathcal{D}$ is a probability of the form

$$P\{\exists \text{ an occupied path in } \overline{\mathcal{D}} \text{ from the arc } [a, b] \text{ to the arc } [c, d]\},$$

where $\overline{\mathcal{D}}$ = closure of \mathcal{D} , and a, b, c, d are four points on $\partial\mathcal{D}$ such that one successively meets these points as one traverses $\partial\mathcal{D}$ counterclockwise, and the interiors of the four arcs $[a, b]$, $[b, c]$, $[c, d]$ and $[d, a]$ are disjoint. We may also replace “occupied path” by “vacant path” in this definition. It seems reasonable to require that each crossing probability converges to some limit if our percolation configuration converges. As we shall see soon that this is indeed the case in the Stas’ development. However, see [6] and [7] for a stricter sense of convergence.

To be more specific, let \mathcal{D} be a Jordan domain in \mathbb{R}^2 with a smooth boundary $\partial\mathcal{D}$. Also let $\tau = \exp(2\pi/3)$ and consider three points of $\partial\mathcal{D}$ and label these $A(1)$, $A(\tau)$, $A(\tau^2)$ as one traverses $\partial\mathcal{D}$ counterclockwise. (More general \mathcal{D} should be allowed, but we don’t want to discuss technicalities here.) As shown by Stas, there then exist three functions

$$h(A(\alpha), A(\tau\alpha), A(\tau^2\alpha), z), \quad \alpha \in \{1, \tau, \tau^2\},$$

which are the unique harmonic solutions of the mixed Dirichlet-Neumann problem

$$\begin{aligned} h(A(\alpha), A(\tau\alpha), A(\tau^2\alpha), z) &= 1 \text{ at } A(\alpha), \\ h(A(\alpha), A(\tau\alpha), A(\tau^2\alpha), z) &= 0 \text{ on the arc } A(\tau\alpha), A(\tau^2\alpha), \\ \frac{\partial}{\partial(\tau\nu)} h(A(\alpha), A(\tau\alpha), A(\tau^2\alpha), z) &= 0 \text{ on the arc } A(\alpha), A(\tau\alpha), \\ \frac{\partial}{\partial(-\tau^2\nu)} h(A(\alpha), A(\tau\alpha), A(\tau^2\alpha), z) &= 0 \text{ on the arc } A(\tau^2\alpha), A(\alpha), \end{aligned} \quad (2.4)$$

where these functions are regarded as functions of z , and ν is the counterclockwise pointing unit tangent to $\partial\mathcal{D}$. The harmonic solution to these boundary conditions (2.4) is unique, and hence its determination is a conformally invariant problem. More specifically, let Φ be a conformal equivalence between \mathcal{D} and a domain $\tilde{\mathcal{D}}$, and for simplicity assume that the equivalence extends to $\partial\mathcal{D}$. Let \tilde{h} be the harmonic solution of the boundary problem (2.4) with A replaced by $\tilde{A} = \Phi(A)$. Then the uniqueness of the solution implies that

$$h(A(\alpha), A(\tau\alpha), A(\tau^2\alpha), z) = \tilde{h}\left(\Phi(A(\alpha)), \Phi(A(\tau\alpha)), \Phi(A(\tau^2\alpha)), \Phi(z)\right).$$

In shorter notation,

$$h = \tilde{h} \circ \Phi. \quad (2.5)$$

Thus, the solution of (2.4) is a conformal invariant of the points $A(1), A(\tau), A(\tau^2), z$ and the domain \mathcal{D} . By the Riemann mapping theorem we may choose Φ such that $\tilde{\mathcal{D}}$ has a simple form and then use (2.5) to obtain h on \mathcal{D} . Carleson observed that if we take $\tilde{\mathcal{D}}$ to be an equilateral triangle, then the solution $\tilde{h}(A(\alpha), A(\tau\alpha), A(\tau^2\alpha), z)$ is just a linear function which is 1 at the vertex $A(\alpha)$, and 0 on the opposite side $(A(\tau\alpha), A(\tau^2\alpha))$, and similarly when α is replaced by $\tau\alpha$ or $\tau^2\alpha$. For Stas this elegant form made the problem that much more attractive to work on.

Stas achieves his main result by making the following choices: On the triangular lattice, let $A(1) = (2/\sqrt{3}, 0)$, $A(\tau) = (1/\sqrt{3}, 1)$, $A(\tau^2) =$ the origin. These are the vertices of an equilateral triangle \mathcal{D} of height 1 and one vertex at the origin. One further takes z on the arc $[A(\tau^2), A(1)] = [(0, 0), A(1)]$. Actually we are cheating a bit because the points $A(1), A(\tau), A(\tau^2)$ and z may not lie in $\delta\mathcal{L}$, but we shall ignore this difficulty here and on several places below. For $\alpha \in \{1, \tau, \tau^2\}$, and $z \in [(0, 0), A(1)]$, define

$$\begin{aligned} Q_\alpha^\delta(z) &= \text{there exists in } \mathcal{D} \text{ a simple, occupied path, from the} \\ &\quad \text{arc } [A(\alpha), A(\tau\alpha)] \text{ to the arc } [A(\tau^2\alpha), A(\alpha)], \text{ and this} \\ &\quad \text{path separates } z \text{ from the arc } [A(\tau\alpha), A(\tau^2\alpha)], \end{aligned} \quad (2.6)$$

and

$$H^\delta(A(\alpha), A(\tau\alpha), A(\tau^2\alpha), z) = P\{Q_\alpha^\delta(z)\}. \quad (2.7)$$

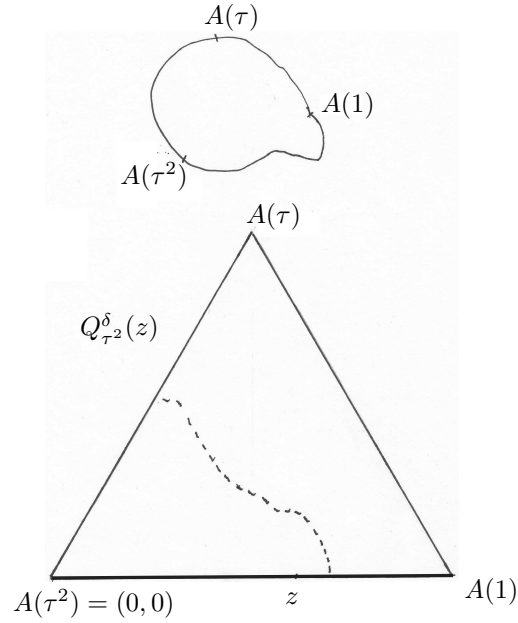

Figure 2.

Stas then formulates his main result as follows: For percolation on $\delta\mathcal{L}$, with \mathcal{L} the triangular lattice, as $\delta \rightarrow 0$,

$$H^\delta(A(\alpha), A(\tau\alpha), A(\tau^2\alpha), z) \rightarrow h(A(\alpha), A(\tau\alpha), A(\tau^2\alpha), z), \text{ uniformly on } \mathcal{D}. \quad (2.8)$$

The basic structure of the argument is now well known. It is shown that the H^δ are Hölder continuous, so that every sequence $\delta_n \rightarrow 0$ has a further subsequence δ_n^* along which the functions $H^{\delta_n^*}$ converge. Moreover the limit along this subsequence has to be harmonic and to satisfy the boundary conditions (2.4). The limit is therefore unique and independent of the choice of the subsequence δ_n^* . Thus $\lim_{\delta \rightarrow 0} H^\delta$ exists and is harmonic and conformally invariant (because the solution h to the problem (2.4) is conformally invariant). Note that this proof also yields the convergence of crossing probabilities to a computable limit. Indeed, it follows directly from the definitions that $Q_{\tau^2}^\delta(z)$ is just the event that there exists a crossing in \mathcal{D} from the arc $[A(\tau), A(\tau^2)]$ to the arc $[z, A(1)]$. It then follows from (2.8) that the probability of the existence of such a crossing converges, (as $\delta \rightarrow 0$) to $h(A(\tau^2), A(1), A(\tau), z_1) = 1 - z_1\sqrt{3}/2$, where $\|z - (z_1, 0)\| \rightarrow 0$. The value $1 - z_1\sqrt{3}/2$ comes from the fact that $h(z)$ is linear on the segment from $A(\tau^2)$ to $A(1)$ and that $z \rightarrow (z_1, 0)$ as $\delta \rightarrow 0$.

Stas' proof is quite ingenious. Quite apart from the clever introduction of the variable z , there are steps which one would never expect to work. It uses estimates which rely on quite unexpected cancellations. The principal part of

the argument is to show that any subsequential limit (as $\delta \rightarrow 0$ through some subsequence δ_n) of the H^δ is harmonic. In turn, this relies on the H^δ being approximations to discrete harmonic functions. Rather than trying to prove harmonicity locally from properties of a second derivative, Stas shows that certain contour integrals of H^δ tend to zero as $\delta \downarrow 0$ and applies Morera's theorem.

Thus these crossing probabilities have limits, which can be computed explicitly. These limits agree with Cardy's formula ([8]). This shows that certain finite collections of crossings of (suitably oriented equilateral) triangles converge weakly and that their probabilities behave as expected, or desired. But much more can be said. [6, 7], and later [4, 23], show that in "the full scaling limit" there is also weak convergence of the occurrence of loops, and loops inside loops or touching other loops, etc. As stated in the abstract of [5]: "These loops do not cross but do touch each other—indeed, any two loops are connected by a finite 'path' of touching loops."

3. Schramm-Loewner Evolutions (SLE)

A short time before Smirnov's paper, Schramm had tried to find out how conformal invariance could be used (if shown to apply) to study also other models than percolation. Loewner introduced his evolutions when he tried to prove Bieberbach's conjecture. Roughly speaking, Loewner represented a family of curves (one for each $z \in \mathbb{H}$) by means of a single function U_t . Here \mathbb{H} is the open upper halfplane, U_t is a given function, and after a reparametrization, g_t is a solution of the initial value problem

$$\frac{\partial}{\partial t} g_t(z) = \frac{2}{g_t(z) - U_t}, \quad g_0(z) = z. \quad (3.1)$$

Let

$$T_z = \sup\{s : \text{solution is well defined for } t \in [0, s) \text{ with } g_s(z) \in \mathbb{H}\}$$

and $H_t := \{z : T_z > t\}$. Then g_t is the unique conformal transformation from H_t onto \mathbb{H} for which $g_t(z) - z \rightarrow 0$ as $z \rightarrow \infty$ (see [14], Theorem 4.6). The g_t arising in this way are called *Loewner chains* and $\{U_t\}$ the *driving function*. See [14], Theorem 4.6. The original Loewner chains were defined without any probability concepts. In particular the driving function $\{U_t\}$ was deterministic. [16] raised the question whether a random driving function could produce some of the known random curves as Loewner chain $\{g_t\}$. Schramm showed in [16] that if the process $\{g_t\}$ has certain Markov properties, then one can obtain this process as Loewner chain only if the driving function is $\sqrt{\kappa} \times$ Brownian motion, for some $\kappa \geq 0$. The processes which have such a driving function are called SLE's (originally this stood for "stochastic Loewner Evolution", but is now commonly read as Schramm-Loewner evolution). When a chain is an SLE $_\kappa$ (in

obvious notation) new computations become possible or much simplified. In particular, the existence and explicit values of most of the critical exponents have now been rigorously established (but see questions Q2 and Q4 below). Stas has made major contributions to these determinations in [15, 22]. In particular he provided essential steps for showing that a certain interface between occupied and vacant sites in percolation is an SLE_6 curve.

The SLE calculations confirm predictions of physicists, as well as a conjecture of Mandelbrot. As a result, the literature on SLE_κ has grown by leaps and bounds in the last few years, and the study of properties of SLE is becoming a subfield by itself. SLE_κ processes with different κ can have quite different behavior. A good survey of percolation and SLE is in [17], and [14] is a full length treatment of SLE.

4. Generalization and Some Open Problems

I don't know of any lattice model in physics which has as much independence built in as percolation. It is therefore of great significance that Stas has a way to attack problems concerning the existence and conformal invariance of a scaling limit for some models with dependence between sites, and in particular for the two-dimensional Ising model. This is perhaps the oldest lattice model, and the literature on it is enormous. I am largely ignorant of this literature and have not worked my way through Stas' papers on these models. Nevertheless I am excited by the fact that Stas is seriously attacking such models.

For the people who are new to this, the Ising model again assigns a random variable (usually called a spin) to each site of a lattice \mathcal{L} . Denote the spin at a site v by $\sigma(v)$. Again $\sigma(v)$ can take only two values, which are usually taken to be ± 1 . The interaction between two sites u and v is $J(u, v)\sigma(u)\sigma(v)$ and in the simplest case

$$J(u, v) = \begin{cases} J & \text{if } u \text{ and } v \text{ are neighbors} \\ 0 & \text{otherwise.} \end{cases}$$

We restrict ourselves to this simplest case, which takes $J \geq 0$ constant. However, in order to discuss boundary conditions we also need another constant, \tilde{J} say. For any *finite* set $\Lambda \subset \mathcal{L}$ we consider the probability distribution of the spin configuration on Λ . This configuration is of course the vector $\{\sigma(v)\}_{v \in \Lambda}$, and so can also be viewed as a point in $\{-1, 1\}^\Lambda$. For any fixed $\tilde{\sigma}$ and Λ we define

$$H(\sigma, \tilde{\sigma}) = H_\Lambda(\sigma, \tilde{\sigma}) = - \sum_{u, v \in \Lambda} J\sigma(u)\sigma(v) - \sum_{u \in \Lambda, v \notin \Lambda} \tilde{J}\sigma(u)\tilde{\sigma}(v), \quad (4.1)$$

and the normalizing constant (also called partition function)

$$Z = Z(\Lambda, \beta, \tilde{\sigma}) = \sum_{\sigma} \exp \left[-\beta H_\Lambda(\sigma, \tilde{\sigma}) \right].$$

Here the sum over σ runs over $\{-1, 1\}^\Lambda$, the collection of possible spin configurations on Λ . $\beta \geq 0$ is a parameter, which is usually called the “inverse temperature.”

Let $\tilde{\sigma}$ be fixed outside Λ . Then, given the boundary condition $\sigma(v) = \tilde{\sigma}(v)$ for $v \notin \Lambda$, the distribution of the spins in Λ is given by

$$P\{\sigma(u) = \tau(u) \text{ for } u \in \Lambda \mid \sigma(v) = \tilde{\sigma}(v), v \notin \Lambda\} = [Z(\Lambda, \beta, \tilde{\sigma})]^{-1} \exp \left[-\beta H_\Lambda(\tau, \tilde{\sigma}) \right].$$

This defines a probability measure for the spins in a finite Λ . A probability distribution for all spins simultaneously has to be obtained by taking a limit as $\Lambda \uparrow \mathcal{L}$. The second sum in the right hand side of (4.1) shows the influence of boundary conditions. At sufficiently low temperature there can be two extremal states, obtained by taking $\Lambda \uparrow \mathcal{L}$ under different boundary conditions. It now becomes unclear how to deal with boundary conditions when one wants to take a continuum limit.

To conclude, here are some problems on percolation. These also have appeared in other lists, (see in particular [17]), but you may like to be challenged again.

Q1 Prove the existence and find the value of critical exponents of percolation on other two-dimensional lattices than the triangular one and establish universality in two dimensions.

This seems to be quite beyond our reach at this time. Probably even more so is the same question in dimension > 2 .

Q2 Prove a power law and find a critical exponent for the probability that there are j disjoint occupied paths from the disc $\{z : |z| \leq r\}$ to $\{z : |z| > R\}$. For $j = 1$ this is the one-arm problem of [15]. For $j \geq 2$, the problem is solved, at least for the triangular lattice, if some of the arms are occupied and some are vacant (see Theorem 4 in [22]), but it seems that there is not even a conjectured exponent for the case when all arms are to be occupied or all vacant.

More specific questions are

Q3 Is the percolation probability (right) continuous at p_c ? Equivalently, is there percolation at p_c ? This is only a problem for $d > 2$. The answer in $d = 2$ is that there is no percolation at p_c ;

Q4 Establish the existence and find the value of a critical exponent for the expected number of clusters per site. This quantity is denoted by

$$\kappa(p) = \sum_{n=1}^{\infty} \frac{1}{n} P_p\{|C| = n\}$$

in [10], p. 23. The answer is still unknown, even for critical percolation on the two-dimensional triangular lattice. It is known that $\kappa(p)$ is twice differentiable on $[0, 1]$, but it is believed that the third derivative at p_c fails to exist; see [12], Chapter 9. This problem is mainly of historical interest, because there was an attempt to prove that p_c for bond percolation on \mathbb{Z}^2 equals $1/2$, by showing that $\kappa(p)$ has only one singularity in $(0, 1)$.

5. Conclusion

I have been amazed and greatly pleased by the progress which Stas Smirnov and coworkers have made in a decade. They have totally changed the fields of random planar curves and of two dimensional lattice models. Stas has shown that he has the talent and insight to produce surprising results, and his work has been a major stimulus for the explosion in the last 15 years or so of probabilistic results about random planar curves.

As some of the listed problems here show, there still are fundamental, and probably difficult, issues to be settled. I wish Stas a long and creative career, and that we all may enjoy his mathematics.

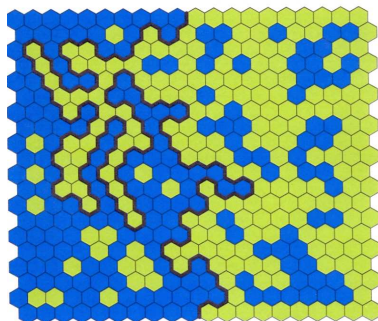

Figure 3.

References

- [1] S.R. Broadbent, *in discussion of Symposium on Monte Carlo methods*, J. Roy. Stat. Soc. (B) **16** (1954) 68.
- [2] S.R. Broadbent and J.M. Hammersley, *Percolation processes*, Proc. Cambr. Phil. Soc. **53** (1957) 629–641 and 642–645.
- [3] R.M. Burton and M. Keane, *Density and uniqueness in percolation*, Comm. Math. Phys. **121** (1989) 501–505.
- [4] F. Camia, *Scaling limits of two-dimensional percolation: an overview*, arXiv:0810.1002v1.
- [5] F. Camia and C.M. Newman, *Continuum nonsimple loops and 2D critical percolation*, J. Stat. Phys. **116** (2004) 157–173.
- [6] F. Camia and C.M. Newman, *Two-dimensional critical percolation: the full scaling limit*, Comm. Math. Phys. **268** (2006) 1–38.
- [7] F. Camia and C.M. Newman, *Critical percolation exploration path and SLE_6 : a proof of convergence*, Probab. Theory and Relat. Fields **139** (2007) 473–519.
- [8] J.L. Cardy, *Critical percolation in finite geometries*, J. Phys. A, **25** (1992) L201–L206.

-
- [9] M.A.C.E. De Volson Wood, Problem 5, Amer. Math. Monthly, **1** (1894) 211.
 - [10] G. Grimmett, *Percolation, second edition*, 1999, Springer-Verlag.
 - [11] G. Grimmett, *The random cluster model*, 2006, Springer-Verlag.
 - [12] H. Kesten, *Percolation theory for mathematicians*, 1982, Birkhäuser.
 - [13] R.P. Langlands, C. Piget, Ph. Pouliot, and Y. Saint-Aubin, *On the universality of crossing probabilities in two-dimensional percolation*, J. Stat. Phys. **67** (1992) 553–574.
 - [14] G.F. Lawler, *Conformally invariant processes in the plane*, Amer. Math. Soc., Math. Surveys and Monographs, vol. **114** (2005).
 - [15] G.F. Lawler, O. Schramm and W. Werner, *One-arm exponent for critical 2D percolation*, Elec. J. Probab. **7** (2002) Paper # 2.
 - [16] O. Schramm, *Scaling limits of loop-erased random walks and uniform spanning trees*, Israel J. Math. **118** (2000) 221–288.
 - [17] O. Schramm, *Conformally invariant scaling limits: an overview and a collection of problems*, pp. 513-543 in Proc. Internat. Congress of Mathematicians, Madrid, 2006.
 - [18] S. Smirnov I, *Critical percolation in the plane. Conformal invariance, Cardy's formula, scaling limits*, C.R.Acad. Sci. Paris Sér.I Math. **333** (2001) 239–244.
 - [19] S. Smirnov II, *long version of I*.
 - [20] S. Smirnov, *Towards conformal invariance of 2D lattice models*, Proc. Internat. Congress mathematiciens **II**, Madrid, Spain (2006) 1421.
 - [21] S. Smirnov and H. Duminil-Copin, *The connective constant of the honeycomb lattice equals $\sqrt{2} + \sqrt{2}$* , arXiv:
 - [22] S. Smirnov and W. Werner, *Critical exponents for two-dimensional percolation*, Math. Res. Letters **8** (2001) 729–744.
 - [23] N. Sun, *Conformally invariant scaling limits in planar critical percolation*, arXiv:0911.0063v1.
 - [24] W. Werner, *Random planar curves and Schramm-Loewner evolutions*, Lecture Notes in Math, vol. **1840**, J. Picard ed., Springer-Verlag 2004.

Cédric Villani

Studied Mathematics at École Normale Supérieure in Paris from 1992 to 1996;
Ph.D., Université Paris-Dauphine, 1998.

Positions held

Assistant Professor at École Normale Supérieure in Paris, 1996-2000.

Professor at École Normale Supérieure de Lyon, 2000-

Semester-long visiting positions in Georgia Tech, Atlanta (1999),

Miller Institute, Berkeley (2004) and Institute for Advanced Study, Princeton (2009)

Director of the Institut Henri Poincaré (IHP) in Paris, 2009-

Part-time visitor of the Institut des Hautes Études Scientifiques (IHES), 2009 -

The work of Cédric Villani

Horng-Tzer Yau*

1. Introduction

The starting point of Cédric Villani's work goes back to the introduction of entropy in the nineteenth century by L. Carnot and R. Clausius. At the time, entropy was a vague concept and its rigorous definition had to wait until the fundamental work of L. Boltzmann who introduced nonequilibrium statistical physics and the famous H functional. Boltzmann's work, though a fundamental breakthrough, did not resolve the question concerning the nature of entropy and time arrow; the debate on this central question continued for a century until today. J. von Neumann, in recommending C. Shannon to use entropy for his uncertainty function, quipped that entropy is a good name because "nobody knows what entropy really is, so in a debate you will always have the advantage".

The first result of Villani I will report on concerns the fundamental connection between entropy and its dissipation. In this work, we will see that rigorous mathematical analysis is not just a display of powerful analytic skill, but also leads to deep insights into nature. Based on this work, Villani has developed a general theory, hypercoercivity, which applies to broad systems of equations. In a separate direction, entropy was used by Villani as a fundamental tool in optimal transport and the study of curvature in metric spaces. Finally, I will describe Villani's work on Landau damping, which predicts a very surprising decay (and thus the word damping) of the electric field in a plasma *without* particle collisions, and therefore without entropy increase. This is in sharp contrast with Boltzmann's picture that the time irreversibility comes from collision processes.

2. Boltzmann Equation

The Boltzmann equation was derived by L. Boltzmann in 1873 based on his physical intuition of collision processes. The most striking feature of the

*Partially supported by NSF grants DMS-0757425, 0804279.

Department of Mathematics, Harvard University, Cambridge MA 02138.
E-mail: htyau@math.harvard.edu

Boltzmann equation, the time irreversibility, contradicts the reversibility of the Newton equations. This fact is most concisely expressed via the Boltzmann H-theorem stating that the entropy

$$S = - \iint f \log f \, dv \, dx$$

is always nondecreasing. Furthermore, the entropy production vanishes if and only if the state is spatially homogeneous and Maxwellian in the velocity variable. The Boltzmann H-theorem is semi-rigorous in the sense that if the solution to the Boltzmann equation is sufficiently smooth then the original proof of Boltzmann is rigorous. The mathematical study of the Boltzmann equation started perhaps from T. Carleman and H. Grad in the middle of the last century. Despite decades of intensive research, most fundamental questions concerning the Boltzmann equation remain open, e.g., 1. Are solutions of the Boltzmann equation smooth if the initial data are sufficiently smooth? 2. The Boltzmann H-theorem states that the entropy increases, but what is the rate? Or, more generally, how fast do solutions to the Boltzmann equation approach the equilibrium (Maxwellian) states?

The first question, the regularity of the Boltzmann equation, is only understood for small perturbation of equilibrium measures. There is a general framework of renormalized solutions developed by R. DiPerna and P.-L. Lions [16], but precise estimates on the solutions remain elusive. The second question, the decay to equilibrium for the Boltzmann equation, is where Villani made his fundamental contribution. Before we describe Villani's work in some detail, several important recent results concerning the Boltzmann equation should be mentioned here. This incomplete list includes the well-posedness and the approach to equilibrium for small perturbation data by Y. Guo [24], and the recent extension of this approach to long-range interactions and soft potentials by P. Gressman and R. Strain [23], the weak shock solutions by S.-H. Yu [52], the derivation of incompressible Navier-Stokes equations from the Boltzmann equation by C. Bardos, F. Golse, D. Levermore and L. Saint-Raymond [5, 17].

The Boltzmann equation is given by

$$\partial_t f + v \nabla_x f = Q(f, f)$$

where $f(t, x, v)$ is the probability density in the phase space at the time t . The nonlinear term Q is the collision operator

$$Q(f, f) = \iint [f(v')f(v'_*) - f(v)f(v_*)]B(v - v_*, \sigma) \, dv_* \, d\sigma,$$

where v, v_* are the incoming velocities, v', v'_* the outgoing velocities, σ the collision angle and B is the scattering kernel depending on the details of the microscopic interactions. The Boltzmann H-functional (negative of the entropy) is defined by

$$H(f) = \int_{\mathbb{R}^3} \int_{\mathbb{R}^3} f(x, v) \log f(x, v) \, dx \, dv$$

and the Boltzmann H-theorem states that

$$\begin{aligned} \partial_t H(f(t)) = -D(f(t)) \leq 0, \quad D(f) = \frac{1}{4} \iiint [f(v)f(v_*) \\ - f(v')f(v'_*)] \log \frac{f(v)f(v_*)}{f(v')f(v'_*)} d\sigma dv dv_*. \end{aligned} \quad (2.1)$$

The dissipation D vanishes if and only if the state is Maxwellian:

$$D(f) = 0 \quad \text{if and only if} \quad f = M_{\rho,u,T} := \rho(x) \frac{e^{-\frac{|v-u(x)|^2}{2T(x)}}}{(2\pi T(x))^{3/2}} \quad (2.2)$$

where M is any local equilibrium state of the Boltzmann equation with density ρ , velocity u and temperature T which can depend on the space variable. If ρ, u, T are independent of the space variables, M is called a global equilibrium.

To understand the approach to equilibrium via the Boltzmann H-theorem, we first consider the spatially homogeneous case, i.e., the function $f(x, v)$ depends only on v . C. Cercignani in 1983 [11] conjectured that, under suitable assumptions on the collision kernel B , there is a constant K such that

$$D(f) \geq K(f)H(f|M), \quad H(f|M) := \iint dx dv f \log \frac{f}{M} \quad (2.3)$$

where M is a global equilibrium and $H(f|M)$ is the entropy of f relative to a global equilibrium M . The Cercignani conjecture is similar to the logarithmic Sobolev inequality for the diffusion process, but the dissipation operator D is nonlinear in the function f . If the Cercignani conjecture holds, then the decay to global equilibrium would be exponentially fast. Through counterexamples, A.V. Bobylev and C. Cercignani [7] proved that this conjecture is false if the constant K depends on the function f only through finite Sobolev norms and moments. On the other hand, it was shown by E. Carlen and M. Carvalho [12] that $D(f) \geq \Theta_f(H(f|M))$, where the function Θ is not explicit but depends on f only through its moments and some derivatives. The conjecture was finally settled in a joint work by G. Toscani and Villani [45] and the subsequent work by Villani [47]. The conclusion is as surprising as it is beautiful: The Cercignani conjecture is in general false, but it is always almost correct in the following sense.

Theorem 2.1. *For a reasonable physical scattering kernel B , if f is smooth and with certain decay property in high momentum regime, then for any $\varepsilon > 0$ we have*

$$D(f) \geq K_\varepsilon(f)H(f|M)^{1+\varepsilon}$$

where $K_\varepsilon(f)$ depends on the smoothness and moments of f .

This inequality then implies that the entropic convergence rate is faster than $C_\varepsilon(f_0)t^{-1/\varepsilon}$ for any initial smooth data f_0 . This is a much deeper inequality

than the logarithmic Soblev inequality, as the operator D is nonlinear and the inequality fails for $\varepsilon = 0$ except in certain nonphysical situations, such as when the collision kernel is quadratic at large velocities.

Villani's next project in this direction is the very ambitious extension of this theorem to the spatially inhomogeneous case. One's immediate reaction to this question is that this is beyond reach since there is no global existence theory for the Boltzmann equation. The key physical question, however, is to understand the mechanism that leads to relaxation in the space variable. If we assume that good smooth solutions are given, the intrinsic difficulties are immediately visible: The identity $D(f) = 0$ implies that f is a local Maxwellian, but not necessary a global one, i.e., the density, temperature, and velocity parameters in the Maxwellian (2.2) depend on the space variable. Therefore, the relaxation to the global Maxwellian requires an additional mechanism different from the consideration of the entropy production. The only control on the space variable in the Boltzmann equation is the first order operator $v \cdot \nabla_x$. Now we have a formidable problem: It is analogue of a hypoelliptic problem, but the elliptic part is a nonlinear integral operator! Numerically, the entropy does decay very fast in the spatially inhomogeneous case, but the entropy production is far from monotonic. The main result in this direction is the following theorem by L. Desvillettes and Villani [15].

Theorem 2.2. *Suppose that $f_t(x, v)$ is a regular solution to the Boltzmann equation and f_t satisfies some lower bound estimate in the large velocity region. Under some assumptions on the collision kernel B , for any $\varepsilon > 0$ there is a C_ε such that*

$$H(f_t|M) \leq C_\varepsilon(f_0) t^{-1/\varepsilon}$$

where f_0 is the initial value of the Boltzmann equation.

This result assumes that the regularity of $f_t(x, v)$ is given, but is a large data theorem in the sense that there is no smallness condition on the initial function f_0 . With a smallness condition, i.e., if the initial data is near a global Maxwellian, the assumptions of Theorem 2.2 can be verified, see, e.g., [24, 25]. Furthermore, significant progress was made in this direction for soft and long range potentials [23] and the decay rates can be exponentially fast for certain collision operators [22]. The method introduced to prove Theorem 2.2 is a very powerful one; Villani later developed a general theory, hypocoercivity [50], to estimate the large time asymptotics of a general class of hypoelliptic operators.

This program was also continued by younger mathematicians, in particular in the series of papers by C. Mouhot, C. Baranger, R. Strain, M. Gualdani and S. Mischler, on the spectral gap for the linearized Boltzmann operator [6, 34] and on the matching of the nonlinear convergence to equilibrium with the linearized theory, in a homogeneous setting [33] and in an inhomogeneous hypocoercive setting [19].

Finally, we mention that Villani's other work related to the Boltzmann equation includes a series of papers on the influence of grazing collisions, mainly

with L. Desvillettes and R. Alexandre: existence of renormalized solutions (with defect measure) for the Boltzmann equation without cutoff [2], the rigorous derivation of the Fokker–Planck–Landau equation from the Boltzmann equation in the grazing collision limit [46, 3], and sharp regularity bounds associated with entropy production [1].

3. Optimal Transportation and Curvature

The optimal transport problem, also known as Monge–Kantorovich problem, is an ancient engineering problem seeking to minimize the cost to transport mass. For our purpose, the initial and final mass distributions are given by two probability measures μ and ν on a compact measurable metric space X . The goal is to find a measurable map $T : X \rightarrow X$ with $T_{\#}\mu = \nu$ to minimize the transportation cost

$$\int c(x, T(x)) d\mu(x). \quad (3.1)$$

The square root of the minimal transportation cost with the squared distance transportation cost function $c(x, y) = d(x, y)^2$ is called the 2-Wasserstein distance, W_2 , between these two measures. The minimizer T is called the optimal transport map. The existence and uniqueness of the optimal transport map was proved in the Euclidean space by Y. Brenier [9] and in the Riemannian manifolds by R. McCann [32].

The probability measures on the metric space X with the Wasserstein distance constitute a compact metric space, called the *Wasserstein space* $(P(X), W_2) =: P_2(X)$ on X . We now take X to be a compact manifold M with metric tensor g which in turns generates a geodesic distance d and the normalized volume measure $\nu = \text{dvol}_M / \text{vol}_M$. The information (negative of the entropy) $H(\mu)$ of a measure $\mu = \rho \nu$ absolutely continuous w.r.t. ν is defined by

$$H(\mu) = \int \rho \log \rho d\nu.$$

In a study of nonlinear heat equations, F. Otto [38] defined a formal Riemannian structure on $P_2(M)$ and interpreted these equations as gradient flows on the Wasserstein space $P_2(M)$ with this formal Riemannian structure. Subsequently, Otto and Villani [39] found the remarkable property that the entropy, viewed as a functional on the Wasserstein space $P_2(M)$, is concave if the Ricci curvature of the manifold M is nonnegative. This provided the first link between the concavity of entropy on the Wasserstein space and the Ricci curvature of the underlying manifold. This relation was subsequently established rigorously in [13], partly motivated by the earlier work [31]. Otto and Villani [39] also argued that the converse should hold, and it was rigorously established in [41].

If we replace the convexity of entropy by a lower bound K on the Hessian of entropy on $P_2(M)$, the corresponding condition on the Ricci curvature becomes

the lower bound

$$\text{Ric} \geq Kg.$$

Furthermore, the volume measure can be generalized to the weighted volume measure $e^{-\Phi} \text{dvol}$ provided the Ricci curvature is replaced by the Bakry-Émery tensor

$$\text{Ric}_\infty := \text{Ric} + \text{Hess}(\Phi) \geq Kg.$$

Using this heuristic idea, Otto and Villani [39] then provided a unified approach to a wide range of inequalities in analysis and geometry including the logarithmic Sobolev inequality and Talagrand's concentration inequality.

If $P_2(M)$ is a regular Riemannian manifold, a lower bound K on the Hessian of the entropy functional is equivalent to the displacement convexity inequality

$$H(\mu_t) \leq (1-t)H(\mu_0) + tH(\mu_1) - K \frac{t(1-t)}{2} W_2(\mu_0, \mu_1)^2 \quad (3.2)$$

for any Wasserstein geodesic μ_t . Notice that this definition depends only on the concept of geodesic on the Wasserstein space which can be defined on any metric space. There is no need for a Riemannian structure on M if we take (3.2) as the definition that the Ricci curvature on a metric space X is bounded below by K . With this definition of a lower bound on the Ricci curvature, J. Lott and Villani [36] proved the fundamental stability result that the lower bound on the Ricci curvature is stable under the Gromov-Hausdorff convergence. A closely related definition of Ricci curvature lower bounds, and similar stability results were obtained independently by K.-T. Sturm [43, 44]. The main statement of Lott-Villani's results can be stated as follows.

Theorem 3.1. *Let $\{(X_i, d_i, \nu_i)\}$ be a sequence of compact measured length spaces and $\lim_{i \rightarrow \infty} (X_i, d_i, \nu_i) = (X, d, \nu)$ in the measured Gromov-Hausdorff topology. If the Ricci curvature of (X_i, d_i, ν_i) is bounded below by K then the Ricci curvature of (X, d, ν) is also bounded below by K .*

This theorem demonstrates the robustness of this definition of Ricci curvature lower bounds. On the other hand, the definition is also a very effective notion since it allows one to generalize many theorems in Riemannian geometry to the setting of metric spaces, including the Bishop-Gromov theorem, logarithmic Sobolev inequality and Bonnet-Myers theorem. Moreover, the definition can easily be discretized [8]. We note that there are other notions and definitions of curvatures on metric spaces or graphs. This includes the work of Y. Ollivier [37] and F. R. Chung and S.-T. Yau's definitions of curvatures on graphs [18, 28].

To summarize, Villani has brought the tools of entropy and its time-evolution from the study of convergence to equilibrium in the Boltzmann equation to a geometric setting involving the Wasserstein space. In addition to the Ricci curvature, Villani has explored connections with other geometric or analytic problems, such as the Sobolev inequality, for which he has provided a

new proof based on optimal transport and entropy-type functionals, in collaboration with D. Cordero-Erausquin and B. Nazaret [14]. Like [36], this paper was a starting point for other developments, including the work of A. Figalli, F. Maggi and A. Pratelli [21] on quantitative anisotropic isoperimetric inequalities. Villani also wrote a series of papers with A. Figalli, G. Loeper and L. Rifford relating the smoothness of optimal transport with the shape of the cut locus in Riemannian geometry [30, 20].

4. Landau Damping

The last theorem of Villani I will describe is a rigorous proof of Landau damping in the nonlinear setting. The fundamental equation governing plasma dynamics is the Vlasov-Poisson equation, which, for periodic data is given by

$$\partial_t f + v \nabla_x f + E \nabla_v f = 0, \quad f(t, x, v) \geq 0$$

where $f(t, x, v)$ is the density of charged particles with velocity $v \in \mathbb{R}^3$ at $x \in \mathbb{T}^3$, the unit torus in \mathbb{R}^3 . The electric field E is related to the density of charged particles $\rho(t, x) = \int f(t, x, v) dv$ via the Poisson equation

$$E := E[\rho] := -\nabla \phi, \quad -\Delta \phi = \rho(x) - 1$$

where the constant 1 is the density of background charges normalized to be one. This equation describes the dynamics of galaxies if we make a sign change in the electric field due to the sign difference between the Coulomb and gravitational forces. The result I will describe is valid with both signs, but I will use the language of plasma physics.

The Vlasov-Poisson equation describes collisionless dynamics and is time reversible. It is well known that dissipative dynamics often approach equilibrium exponentially fast, but for reversible dynamics the state f_t at any given time carries the same information as the initial data and decay to equilibrium can only be valid after certain averaging. On the other hand, fast relaxation to equilibrium in nature is ubiquitous even for systems governed by Newtonian dynamics. The common explanation has been that the relaxation is due to collision processes which produce dissipation. In 1946, L. Landau [27] revolutionized this common belief by arguing that the electric field in the Vlasov-Poisson equation, which is a collisionless equation, decays exponentially fast. He computed this rate of convergence for the linearized Vlasov-Poisson equation. This astonishing discovery is thus termed Landau damping. Despite intensive studies, the understanding of Landau damping for the Vlasov-Poisson equation is very limited.

The Vlasov-Poisson equation has infinitely many stationary solutions. In fact, any density $g(v)$ satisfying the normalization condition $\int g(v) dv = 1$ is a stationary solution. The stability analysis of the linearized Vlasov-Poisson equation was mainly due to the work of O. Penrose [40] in the sixties. It states

that f^0 is stable if for any $\sigma \in S^2$ and $f_\sigma(v) = \int_{v\sigma+\sigma^\perp} f^0(z) dz$, then for any w such that $f'_\sigma(w) = 0$ one has

$$\int \frac{f'_\sigma(v) dv}{v-w} < 1.$$

The Landau damping for the linearized Vlasov-Poisson was already understood in the sixties by the work of A. Saenz [42]; for the quasi-linear case only nonrigorous results were available. On the other hand, it was pointed out by G. Backus [4] that the linear approximation is not expected to be valid for the full nonlinear equation in the large time regime. For the nonlinear Landau damping, the only partial results available were examples of solution to the Vlasov-Poisson equation that exhibit Landau damping [10, 26]. Last year Mouhot and Villani [35] proved that, for any analytic data near an analytic linearly stable stationary state, the electric field decay exponentially fast. Notice that the analyticity assumption is not an artifact of the proof, it is in fact necessary [29]. This resolves the long standing problem of Landau damping. We will not be able to state their theorem precisely nor in its general form, but the following limited version in the physical dimension $d = 3$ gives a flavor of the depth of the full theorem.

Theorem 4.1 (nonlinear Landau damping for general interaction). *There is an analytic norm $\|\cdot\|_a$ on functions of the phase space such that the following holds: Let $f^0 : \mathbb{R}^d \rightarrow \mathbb{R}_+$ be an analytic stationary state satisfying Penrose's linear stability criterion. Suppose the initial profile $f_i \geq 0$ is near the analytic stationary state in the sense that*

$$\|f_i - f^0\|_a \leq \varepsilon, \quad (4.1)$$

for some ε sufficiently small. Then there are analytic profiles $f_{+\infty}(v)$, $f_{-\infty}(v)$ such that

$$f(t, \cdot) \xrightarrow{t \rightarrow \pm\infty} f_{\pm\infty} \quad \text{weakly}$$

exponentially fast. Furthermore, the marginal density of the unique solution of the nonlinear Vlasov equation with initial value $f(0, \cdot) = f_i$ converges exponentially fast as time $t \rightarrow \pm\infty$, i.e., there exists ρ_∞ and $\lambda > 0$ such that for all integer r we have

$$\|\rho(t, \cdot) - \rho_\infty\|_{C^r(\mathbb{T}^3)} \leq C e^{-\lambda|t|}, \quad t \rightarrow \pm\infty, \quad (4.2)$$

where C^r denotes the L_∞ norm of the derivatives up to order r .

Since the Vlasov-Poisson equation is time reversible, the profiles f_t keep the memory of the initial datum for all time. The fast relaxations in Mouhot-Villani's theorem only refer to averaged quantities such as density in the position space or in the weak sense. This is due to the fact that weak convergence preserves only the information of low frequency modes; the information at low

frequencies was transferred to high frequencies to “maintain the constant total information for all times”. Although f_t carries all information of the initial data for all time, more and more information is stored at high frequency modes. Hence if we only look at low frequency modes (such as weak convergence), there is a loss of information and this is responsible for the fast relaxation of various averaged quantities. This resembles the phenomena in turbulence and it requires very precise understanding of this transfer of information to yield a mathematical proof. Mouhot-Villani’s theorem is the first rigorous result to establish a fast decay to equilibrium, a time irreversible behavior, in confined collisionless time-reversible dynamics.

5. Conclusion

In Villani’s work, we have seen not only rigorous mathematical analysis providing deep insights into physical behavior, but also important new mathematics emerging from the study of natural phenomena, in the spirit of Maxwell and Boltzmann. Besides his research articles, Villani has written extensive surveys and books [48, 50, 49, 51], and, through these, as well as the insights of his work, he has inspired a generation of young mathematicians with deep, rich, physically motivated mathematical questions. We are witnessing the beginning of Villani’s spectacular career and influence in shaping the directions of analysis and mathematics.

References

- [1] Alexandre, R., Desvillettes, L., Villani, C. and Wennberg, B.: Entropy dissipation and long-range interactions. *Arch. Ration. Mech. Anal.* 152, no.4, 327–355 (2000).
- [2] Alexandre, R. and Villani, C.: On the Boltzmann equation for long-range interactions. *Comm. Pure Appl. Math.* 55, no.1, 30–70, (2002).
- [3] Alexandre, R. and Villani, C.: On the Landau approximation in plasma physics. *Ann. Inst. H. Poincaré Anal. Non Linéaire* 21, no. 1, 61–95, (2004).
- [4] Backus, G: Linearized plasma oscillations in arbitrary electron velocity distributions. *J. Mathematical Phys.* 1 (1960), 178-191; erratum, 559.
- [5] Bardos, C.; Golse, F.; Levermore, C. D.: Fluid dynamic limits of kinetic equations. II. Convergence proofs for the Boltzmann equation. *Comm. Pure Appl. Math.* 46 (1993), no. 5, 667–753.
- [6] Baranger, C.; Mouhot, C.: Explicit spectral gap estimates for the linearized Boltzmann and Landau operators with hard potentials. *Rev. Mat. Iberoamericana* 21, no. 3, 819–841 (2005).
- [7] Bobylev, A. V. and Cercignani, C.: On the rate of entropy production for the Boltzmann equation. *J. Stat. Phys.* 94, 603–618 (1999).
- [8] Bonciocat, A. I. and Sturm, K. S.: Mass transportation and rough curvature bounds for discrete spaces. *J. Funct. Anal.* 256, no. 9, 2944–2966 (2009).

-
- [9] Brenier, Y.: Polar factorization and monotone rearrangement of vector-valued functions. *Comm. Pure Appl. Math.*, 44, no. 4, 375–417 (1991).
- [10] Caglioti, E., and Maffei, C.: Time asymptotics for solutions of Vlasov–Poisson equation in a circle. *J. Statist. Phys.* 92, 1-2, 301–323 (1998).
- [11] Cercignani, C.: H -theorem and trend to equilibrium in the kinetic theory of gases. *Arch. Mech.* 34, 231–241 (1982).
- [12] Carlen, E. and Carvalho, M.: Strict entropy production bounds and stability of the rate of convergence to equilibrium for the Boltzmann equation. *J. Stat. Phys.* 67, 575–608 (1992)
- [13] Cordero-Erausquin, D.; R. McCann and Schmuckenschläger, M.: A Riemannian interpolation inequality à la Borell, Brascamp and Lieb. *Invent. Math.* 146, no. 2, 219–257 (2001).
- [14] Cordero-Erausquin, D.; Nazaret, B. and Villani, C.: A mass-transportation approach to sharp Sobolev and Gagliardo-Nirenberg inequalities. *Adv. Math.* 182 (2004), no. 2, 307–332.
- [15] Desvillettes, L. and Villani, C.: On the trend to global equilibrium for spatially inhomogeneous kinetic systems: the Boltzmann equation. *Invent. Math.* 159, 245–316 (2005).
- [16] DiPerna, R. J., and Lions, P.-L.: On the Cauchy problem for Boltzmann equations: global existence and weak stability. *Ann. of Math. (2)* 130, 2 (1989), 321–366.
- [17] Golse, F. and Saint-Raymond, L.: The Navier-Stokes limit of the Boltzmann equation for bounded collision kernels. *Invent. Math.* 155 (2004), no. 1, 81–161.
- [18] Chung, F. R. K. and Yau, S.T.: Logarithmic Harnack inequalities *Math. Res. Lett.* 3 (1996), no. 6, 793–812.
- [19] Gualdani M.; Mischler S., Mouhot C.: Factorization for non-symmetric operators and exponential H-theorem, arXiv:1006.5523
- [20] Figalli, A., Rifford, L. and Villani, C.: Nearly round spheres look convex. Preprint (2009).
- [21] Figalli, A.; Maggi, F.; Pratelli, A.: A mass transportation approach to quantitative isoperimetric inequalities, to appear in *Invent. Math.*
- [22] Gressman, P. and Strain, R.: Global strong solutions of the Boltzmann equation without angular cut-off, arXiv:0912.0888v1
- [23] Gressman, P. and Strain, R.: Global Classical Solutions of the Boltzmann Equation with Long-Range Interactions and Soft Potentials, arXiv:1002.3639.
- [24] Guo, Y.: Classical solutions to the Boltzmann equation for molecules with an angular cutoff. *Arch. Ration. Mech. Anal.* 169 (2003), no. 4, 305–353.
- [25] Guo, Y.: The Landau equation in a periodic box. *Comm. Math. Phys.* 231 (2002), no. 3, 391–434.
- [26] Hwang, J.-H. and Velazquez, J.: On the existence of exponentially decreasing solutions of the nonlinear Landau damping problem. *Indiana Univ. Math. J.* 58, no. 6, 2623–2660 (2009).

-
- [27] Landau, L.: On the vibration of the electronic plasma. *J. Phys. USSR* 10 (1946), 25.
- [28] Lin, Y. and Yau, S.T.: Ricci curvature and eigenvalue estimate on locally finite graphs. *Math. Res. Lett.* 17 (2010), no. 2, 343–356.
- [29] Lin, Z. W., Zeng, C. C.: Small BGK waves and nonlinear Landau damping, arXiv:1003.3005
- [30] Loeper, G. and Villani, C.: Regularity of optimal transport in curved geometry: the nonfocal case. To appear in *Duke Math. J.*
- [31] McCann, R. J.: A convexity principle for interacting gases. *Adv. Math.* 128 (1997), no. 1, 153–179
- [32] McCann, R. J.: Polar factorization of maps on Riemannian manifolds. *Geom. Funct. Anal.*, 11, no. 3, 589–608 (2001).
- [33] Mouhot, C.: Rate of convergence to equilibrium for the spatially homogeneous Boltzmann equation with hard potentials. *Comm. Math. Phys.* 261, no. 3, 629–672 (2006).
- [34] Mouhot, C.; Strain, R.: Spectral gap and coercivity estimates for linearized Boltzmann collision operators without angular cutoff. *J. Math. Pures Appl.* 87, no. 5, 515–535 (2007).
- [35] Mouhot, C., and Villani, C.: On Landau damping. arXiv:0904.2760, (2009).
- [36] Lott, J. and Villani, C.: Ricci curvature via optimal transport. *Ann. Math.* 169 (2009), 903–991
- [37] Ollivier, Y.: Ricci curvature of Markov chains on metric spaces. *J. Funct. Anal.* 256 (2009), no. 3, 810–864.
- [38] Otto, F.: The geometry of dissipative evolution equations: the porous medium equation. *Comm. Partial Differential Equations* 26 (2001), no. 1-2, 101–174.
- [39] Otto, F. and Villani, C.: Generalization of an inequality by Talagrand and links with the logarithmic Sobolev inequality. *J. Funct. Anal.* 173 (2000), no. 2, 361–400.
- [40] Penrose, O.: Electrostatic instability of a non-Maxwellian plasma. *Phys. Fluids* 3, 258–265 (1960).
- [41] von Renesse, M.-K. and Sturm, K.-T.: Transport inequalities, gradient estimates, entropy, and Ricci curvature. *Comm. Pure Appl. Math.* 58 (2005), no. 7, 923–940.
- [42] Saenz, A. W.: Long-time behavior of the electric potential and stability in the linearized Vlasov theory. *J. Mathematical Phys.* 6 (1965), 859–875.
- [43] Sturm, K.-T.: On the geometry of metric measure spaces. I. *Acta Math.* 196 (2006), no. 1, 65–131.
- [44] Sturm, K.-T.: On the geometry of metric measure spaces. II. *Acta Math.* 196 (2006), no. 1, 133–177.
- [45] Toscani, G. and Villani, C.: Sharp entropy dissipation bounds and explicit rate of trend to equilibrium for the spatially homogeneous Boltzmann equation. *Commun. Math. Phys.* 203, 667–706 (1999)

- [46] Villani, C.: On a new class of weak solutions to the spatially homogeneous Boltzmann and Landau equations. *Arch. Rational Mech. Anal.* 143, no. 3, 273–307 (1998).
- [47] Villani, C.: Cercignani’s conjecture is sometimes true and always almost true. *Comm. Math. Phys.* 234, 3, 455–490 (2003).
- [48] Villani, C.: A review of mathematical topics in collisional kinetic theory. In *Handbook of mathematical fluid dynamics*, Vol. I. North-Holland, Amsterdam, 2002, pp. 71-305.
- [49] Villani, C.: *Topics in optimal transportation*, vol. 58 of Graduate Studies in Mathematics. American Mathematical Society, Providence, RI, 2003.
- [50] Villani, C.: Hypocoercivity. *Mem. Amer. Math. Soc.* 202, no. 950 (2009).
- [51] Villani, C.: *Optimal transport*, vol. 338 of Grundlehren der Mathematischen Wissenschaften. Springer-Verlag, Berlin, 2009.
- [52] Yu, S. H.: Nonlinear wave propagations over a Boltzmann shock profile, *J. Amer. Math. Soc.*, (2010).

Rolf Nevanlinna Prize

Daniel Alan Spielman

B.A. in Mathematics and Computer Science, Yale University, 1992,

Ph.D. in Applied Mathematics, Massachusetts Institute of Technology, 1995.

Positions held

Assistant Professor of Applied Mathematics, Massachusetts Institute of Technology, 1996 - 2002.

Associate Professor of Applied Mathematics, Massachusetts Institute of Technology, 2002 to 2005.

Professor of Applied Mathematics and Computer Science, Yale University, 2005 -

The work of Daniel A. Spielman

Gil Kalai*

Dan Spielman has made groundbreaking contributions in theoretical computer science and mathematical programming and his work has profound connections to the study of polytopes and convex bodies, to error-correcting codes, expanders, and numerical analysis. Many of Spielman's achievements came with a beautiful collaboration spanned over two decades with Shang-Hua Teng. This paper describes some of Spielman's main achievements.

Section 1 describes smoothed analysis of algorithms, which is a new paradigm for the analysis of algorithms introduced by Spielman and Teng. Section 2 describes Spielman and Teng's explanation for the excellent practical performance of the simplex algorithm via smoothed analysis.

Spielman and Teng's theorem asserts that the simplex algorithm takes a polynomial number of steps for a random Gaussian perturbation of every linear programming problem.

Section 3 is devoted to Spielman's works on error-correcting codes and in particular his construction of linear-time encodable and decodable high-rate codes based on expander graphs. Section 4 describes other directions: spectral graph theory, sparsifiers, graph partitioning, numerical analysis, and linear equation solvers.

1. Smoothed Analysis of Algorithms

I will introduce the motivation for smoothed analysis by quoting Dan Spielman himself:

“Shang-Hua Teng and I introduced smoothed analysis to provide a means of explaining the practical success of algorithms and heuristics that have poor worst-case behavior and for which average-case analysis was unconvincing. The problem of explaining the success of heuristics that ‘work in practice’ has long plagued theoreticians. Many of these have poor worst-case complexity. While one may gain some insight into their performance by demonstrating that they have low average-case complexity, this analysis may be unconvincing as

*Hebrew University of Jerusalem and Yale University. E-mail: kalai@math.huji.ac.il

an average-case analysis is dominated by the performance of an algorithm on random inputs, and these may fail to resemble the inputs actually encountered in practice.”

Smoothed analysis is a hybrid of worst-case and average-case analyses that inherits advantages from both. The smoothed complexity of an algorithm is the maximum over its inputs of the expected running time of the algorithm under slight random perturbations of that input. The smoothed complexity is then measured as a function of both the input length and the magnitude of the perturbations. If an algorithm has low smoothed complexity, then it should perform well on most inputs in every neighborhood of inputs. Smoothed analysis makes sense for algorithms whose inputs are subject to slight amounts of noise in their low-order digits, which is typically the case if they are derived from measurements of real-world phenomena.

The most important example of an algorithm with poor worst-case complexity and excellent practical behavior is the simplex algorithm for linear programming. We will discuss linear programming in the next section. Following Spielman and Teng, the smoothed complexity of quite a few other algorithms, of geometric, combinatorial, and numeric nature, were studied by various authors, see [48] for a survey. Some highlights are: k -means and clustering [5]; integer programming [7]; superstring approximation [30]; Smoothed formulas and graphs [26].

2. Why is the Simplex Algorithm so Good?

2.1. Linear programming and the simplex algorithm. In 1950 George Dantzig (see [10]) introduced the *simplex algorithm* for solving linear programming problems. Linear programming and the simplex algorithm are among the most celebrated applications of mathematics. See [37, 53].

A linear programming problem is the problem of finding the maximum of a linear functional (called a *linear objective function*) on d variables subject to a system of n inequalities. The set of solutions to the inequalities is called the *feasible polyhedron* and the simplex algorithm consists of reaching the optimum by moving from one vertex to a neighboring vertex of the feasible polyhedron. The precise rule for this move is called *the pivot rule*. What we just described is sometimes called the second phase of the algorithm, and there is a first phase where some vertex of the feasible polyhedron is reached.

Understanding the complexity of linear programming and of the simplex algorithm is a major problem in mathematical programming and in theoretical computer science.

Early thoughts. The performance of the simplex algorithm is extremely good in practice. In the early days of linear programming it was believed that the

common pivot rules reach the optimum in a number of steps that is polynomial or perhaps even close to linear in d and n . As we will see shortly, this belief turned out to be false.

A related conjecture by Hirsch asserts that for d -polytopes (bounded polyhedra) defined by n inequalities in d variables there is always a path of length at most $n - d$ between every two vertices. The Hirsch conjecture was recently disproved by Francisco Santos [36]. The known upper bound for diameter of graphs of polytopes is quasi-polynomial in d and n [22]. (Of course, an upper bound for the diameter of the graph of the feasible polyhedron does not guarantee a similar bound for the number of pivots for an effective simplex type algorithm.)

The Klee-Minty example and worst-case behavior. Klee and Minty [24] found that one of the most common variants of the simplex algorithm is exponential in the worst case. In fact, the number of steps was quite close to the total number of vertices of the feasible polyhedron. Similar results for other pivot rules were subsequently found by several authors. No efficient pivot rules for linear programming is known which requires a polynomial number of pivots or even a sub-exponential number of pivot steps for every LP problem. There are randomized algorithms which requires in expectation a sub-exponential number of steps $\exp(K\sqrt{\log nd})$ [19, 34]. Even for randomized algorithms a polynomial number of steps is a distant goal.

$LP \in P$, the ellipsoid method and interior points methods. What can explain the excellent practical performance? In 1979 Khachian [18] proved that $LP \in P$; namely, there is a polynomial time algorithm for linear programming. This had been a major open problem since the complexity classes P and NP were described in the late sixties, and the solution led to the discovery of polynomial algorithms for many other optimization problems [15]. Khachian's proof was based on Nemirovski and Shor's ellipsoid method, which is not practical. For a few years there was a feeling that there is a genuine tradeoff between being good in theory and being good in practice. This feeling was shattered with Karmarkar's 1984 interior point method [20] and subsequent theoretical and practical discoveries.

Average case complexity. We come now to developments that are most closely related to Spielman and Teng's work. Borgwardt [8] and Smale [38] pioneered the study of average case complexity for linear programming. It turns out that a certain pivot rule first introduced by Gass and Saaty called the *shadow boundary rule* is most amenable to average-case study. Borgwardt was able to show polynomial average-case behavior for a certain model that exhibits rotational symmetry. In the mid-80s, three groups of researchers [1, 2, 52] were

able to prove *quadratic* upper bound for the simplex algorithm for very general random models that exhibit certain sign invariance.

2.2. Smoothed analysis of the simplex algorithm. We start with a linear programming (LP) problem:

$$\begin{aligned} \max & \langle \mathbf{c}, \mathbf{x} \rangle, \quad \mathbf{x} \in \mathbf{R}^d \\ \text{subject to} & \mathbf{Ax} \leq \mathbf{b} \end{aligned}$$

Here, \mathbf{A} is an n by d matrix, \mathbf{b} is a column vector of length n , and \mathbf{c} is a column vector of length d .

Spielman and Teng considered a Gaussian perturbation of the matrix A where a Gaussian random variable with variance σ is added independently to each entry of the matrix A .

Theorem 2.1 (Spielman and Teng [43]). *For the shadow-boundary pivot rule, the average number of pivot steps required for a random Gaussian perturbation of variance σ of an arbitrary LP problem is polynomial in d, n , and σ^{-1} .*

Spielman and Teng's proof [43] is truly a tour de force. It relies on a very delicate analysis of random perturbations of convex polytopes.

Let me mention two ingredients of the proof: The shadow-boundary method can be described geometrically as follows. Consider an orthogonal projection of the feasible polytope to two dimensions such that the starting vertex and the optimal vertex are mapped to vertices of the projection. The walk performed by the algorithm (in phase I) is a pre-image of walking along the boundary in the projection. An important step in the proof is to show that the number of vertices¹ in the projection is only polynomial in d, n , and σ^{-1} .

A crucial part of the proof is explaining what a random perturbed polytope looks like. In particular, it is required to prove that the angles at vertices of these polytopes are not "flat." Every vertex corresponds to a solution of d linear equations in d variables and the angle at the vertex is described by a certain algebraic parameter of the linear system called the *condition number*.

The study of condition numbers of random matrices is crucial to Spielman and Teng's original results as well as to many subsequent developments.

2.3. Further developments.

Smoothed analysis of interior point methods. For interior point methods there is also an unexplained exponential gap between the practical and proven

¹The whole difficulty of linear programming consists in on the fact that the number of vertices of the feasible polytope can be exponential in d .

number of iterations. Renegar [35] proved an upper bound of $O(\sqrt{n}L)$ for the number of iterations required for an interior point method to reach the optimum. Here, L is the number of bits in the binary description of the problem. His analysis strongly relies on the notion of condition number we mentioned above. (In fact, Renegar's result gives the upper bound $O(\sqrt{n}R)$ where R is the logarithm of the condition number.) Practical experience tells us that in real-life problems the number of iterations is logarithmic in n . Can smoothed analysis explain this as well?

Dunagan, Spielman, and Teng [11] proved that the expectation of R , the log of the condition number of any appropriately scaled linear program subject to a Gaussian perturbation of variance σ^2 is at most $O(\log nd/\sigma)$ with high probability. This may offer some explanation for the fast convergence practically observed by various interior point methods.

Improvements, extensions, and simplifications. Spielman and Teng themselves, Vershynin [55], Tao and Vu [51], and others over the years have introduced significant improvements to the polynomial estimates, simplifications of various parts of the original proof, and extensions, to more general classes of perturbations. The best-known bound for the polynomial in the theorem that was proved by Vershynin is $\max(d^5 \log^2 n, d^9 \log^4 d, d^3 \sigma^{-4})$.

The framework of smoothed analysis can be rendered more and more convincing by restricting the families of perturbations to more closely model the noise one would actually expect in a particular problem domain. For certain parts of the smoothed analysis, Tao and Vu [51] and Rudelson and Vershynin were able to replace the Gaussian noise by various more general and arguably more realistic types of noise.

Towards a strongly polynomial algorithm for linear programming.

One of the outstanding open problems in computational complexity is that of finding a “strongly polynomial algorithm for linear programming” [32, 39]. This roughly means an algorithm that requires a polynomial number of arithmetic operations in terms of d and n which do not depend on L , the number of bits required to present the inequalities. The number of arithmetic operations required by the simplex algorithm depends exponentially on d but does not depend on L . One can hope that a strongly polynomial algorithm for linear programming will be achieved by some clever pivot rule for the simplex algorithm. The most significant result in this direction is by Tardos [50] and takes an entirely different route. She proved that the polynomial algorithms that are in general not strongly polynomial are strongly polynomial for a large family of linear programming problems that arise in combinatorial optimization.

Based on the smoothed analysis ideas, Kelner and Spielman [23] found a randomized polynomial-time simplex algorithm for linear programming. Finding such an algorithm was a goal for a long time and the result may be a step towards a strongly polynomial simplex algorithm.

3. Linear-time Decodable and Encodable High Rate Codes

3.1. Codes and expanders

Codes. The construction of error-correcting codes [54] is also among the most celebrated applications of mathematics. Error-correcting codes are eminent in today's technology from satellite communications to computer memories.

A binary code C is simply a set of 0-1 vectors of length n . The minimal distance $d(C)$ is the minimal Hamming distance between two elements $x, y \in C$. The same definition extends when the set $\{0, 1\}$ is replaced by a larger alphabet Σ . When the minimal distance is d the code C is capable of correcting $\lfloor d/2 \rfloor$ arbitrary errors. The rate of a code C of vectors of length n is defined as $R(C) = \log |C|/n$. Codes have important theoretical aspects. The classical geometric problem of densest sphere packing is closely related to the problem of finding error-correcting codes. So is the classical question of constructing "block design," which arose in recreational mathematics and later resurfaced in the design of statistical tests.

Error-correcting codes have important applications in theoretical computer science, which have enriched both areas. Codes are crucial in the area of "Hardness of approximations and PCP," and quantum analogs of error correcting codes are expected to be crucial in the engineering and building of quantum computers.

Expanders. Expanders are special types of graphs. Roughly speaking, a graph with n vertices is an expander if every set A of vertices $|A| \leq n/2$ has at least ϵn neighbors outside A . While the initial motivation came from coding theory, expanders quickly found many applications and connections in mathematics and theoretical computer science. See [13] for a comprehensive survey. Pinsker gave a simple probabilistic proof of expander graphs with bounded degree. The first explicit construction was given by Margulis [31]. There are important connections between the expansion properties, spectral properties of the graph's Laplacian [4, 3], and random walks [16]. Number theory enables the construction of a remarkable optimal class of expanders called "Ramanujan graphs" [28].

3.2. From expanders to codes. An important class of codes are those of minimal distance αn errors $\alpha < 1/2$. Finding the largest rate of these codes is a famous open problem. Probabilistic constructions due to Gilbert and Varshamov give the highest known rates for binary codes with minimal-distance αn . The first explicit construction for codes with positive rate that correct a positive fraction of errors (for large n) was achieved by Justesen [17] and was one of the major discoveries of coding theory in the seventies.² A major

²Later, constructions based on algebraic geometry were found which give, for large alphabets, even higher rates than the Gilbert-Varshamov bound.

open problem was to find such codes which admit a linear time algorithm for decoding and for encoding.

In the early sixties Gallager [14] described a method to move from graphs to codes. Michael Sipser and Spielman [49] were able to show that codes that are based on expander graphs (thus called expander codes) have positive rate, correct a positive fraction of errors, and have a simple decoding algorithm. A remarkable subsequent result by Spielman is

Theorem 3.1 (Spielman 1995, [40]). *There is a construction of positive rate linear codes which correct a positive fraction of errors and which admit a linear time algorithm for decoding and for encoding.*

Spielman's full result is quite difficult and requires a substantial extension of Gallager's original construction which is similar to the construction of "superconcentrators" from expanders. Let me explain how Sipser and Spielman were able to construct high-rate codes via expanders.

Start with an expander bipartite graph G with two unbalanced sides A and B . Suppose that vertices in A have degree c and vertices in B have degree d and that $d > c$. (Thus, $|A|d = |B|c$; put $|A| = n$.) The code C will consist of all 0,1 vectors indexed by vertices in A such that for every vertex b of B the coordinates indexed by the neighbors of b sum up to zero. This gives us a linear code (namely, C is a linear subspace of $\{0, 1\}^{|A|}$) of dimension $|A| - |B|$. The minimum distance between two vectors of C is simply the minimal number of ones in a vector in C . Now enters the expansion property. Assume that for every set B' of vertices in B such that $|B'| \leq \alpha|B|$ the number of its neighbors in A is at least $\delta|B'|$, where $\delta = \epsilon c/d$. This implies that every vector in the code C has at least ϵn ones.

3.3. Tornado codes. Dan Spielman has made other important contributions to the theory of error-correcting codes and to connections between codes and computational complexity. Some of his subsequent work on error-correcting codes took a more practical turn. Spielman, together with Michael G. Luby, Michael Mitzenmacher and M. Amin Shokrollahi constructed [29] codes that approach the capacity of erasure channels. Their constructions, which are now called *tornado codes*, have various practical implications. For example, they can be useful for compensating for packet loss in Internet traffic.

4. Fast Linear-system Solvers and Spectral Graph Theory

Spielman recently focused his attention to one of the most fundamental problems in computing: the problem of solving a system of linear equations. Solving large-scale linear systems is central to scientific and engineering simulation, mathematical programming, and machine learning.

Inspired by Pravin Vaidya’s work on iterative solver that uses combinatorial techniques to build preconditioners, Spielman and Teng were able to settle an open problem raised by Vaidya in 1990:

Theorem 4.1 (Spielman and Teng [46]). *There is a nearly linear time algorithm for solving diagonally dominant linear systems.*

Their solver incorporates basic numerical techniques with combinatorial techniques including random walks, separator theory, and low-stretch spanning trees. This endeavor have grown into a body of interdisciplinary work, and in the process

- Numerically motivated combinatorial concepts such as spectral sparsifiers were introduced.
- Efficient graph-theoretic algorithms for constructing sparsifiers were found and applied to matrix approximation.
- Nearly linear-time clustering and partitioning algorithms for massive graphs were developed with the guidance of spectral analysis.

A recent practical fruit is the development of an asymptotically and practically efficient nearly-linear time algorithm by Koutis, Miller and Peng [25], which incorporates Spielman and collaborators’ constructions of low-stretch spanning trees [12] and of sparsifiers [45].

In the rest of this section we will describe three themes in this endeavor, but let me first make a remark about the relation of Spielman’s work with numerical analysis. Numerical analysis may well deserve the title of “queen of applied mathematics” and *thinking numerically* often gives a whole new dimension to mathematical understanding. Algorithms discovered in numerical analysis and scientific computing are among the most important and most useful algorithms known to mankind. Many of the notions and results discussed in Section 1 and in this section are related to numerical analysis. Spielman and Teng [43] proposed smoothed analysis as a framework for the theoretical study of certain numerical algorithms and Spielman’s recent endeavor have built new bridges between numerical analysis and discrete mathematics.

The following themes are heavily entangled in Spielman’s work, but I will describe them separately. For more, see Spielman’s article in these proceedings [41].

Sparsifiers. What is a sparsifier? Very roughly, given a graph G (typically dense, with a quadratic number of edges in terms of the vertices), a sparsifier H is a sparse graph with a linear or nearly linear number of edges that captures (in a sense that needs to be specified) structural properties of G . So expanders can be thought of as sparsifiers of the complete graph.

Spielman and Teng [45] gave a spectral definition of sparsifiers and this definition turned out to be very fruitful. Recent works by Spielman with several

coauthors [6, 42] give answers to the following questions: How are sparsifiers constructed? What are they good for? If sparsifiers are analogs of expanders what are the analogs of Ramanujan graphs? One of the major new results is nearly linear-time algorithms to construct sparsifiers.

Graph partitioning via spectral graph theory. Splitting graphs into a structured collection of subgraphs is an important area in pure and applied graph theory. A tree-like structure is often a goal. And the Lipton-Tarjan separator theorem [27] for planar graphs is an early graph-partitioning result that often serves as a role model.

By bounding the eigenvalue of the Laplacian of bounded-degree planar graphs, Spielman and Teng [45] gave an algebraic proof of the Lipton-Tarjan's theorem and its extensions, providing an explanation of why the spectral partitioning works on practical graphs including finite-element meshes and planar-like graphs.

Solvers for linear systems of equations based on graph Laplacians. In a series of papers Spielman and his coauthors considered systems of linear equations based on Laplacian matrices of graphs. This may look rather special but it is a fascinating class of linear systems and various others systems of linear equations can be reduced to this case. See [41].

Conclusion. The beautiful interface between theory and practice, be it in mathematical programming, error-correcting codes, the search for Ramanujan-quality sparsifiers, the analysis of algorithms, computational complexity theory, or numerical analysis, is characteristic of Dan Spielman's work.

References

- [1] I. Adler and R. M. Karp and R. Shamir, A simplex variant solving an $m \times d$ linear program in $o(\min(m^2, d^2))$ expected number of pivot steps, *J. Complexity*, 3 (1987) 372–387.
- [2] I. Adler and N. Megiddo, A simplex algorithm whose average number of steps is bounded between two quadratic functions of the smaller dimension, *Journal of the ACM*, 4 (1985), 871–895.
- [3] N. Alon. Eigenvalues and expanders, *Combinatorica*, 6 (1986) 83–96, 1986.
- [4] N. Alon and V. D. Milman, λ_1 , isoperimetric inequalities for graphs, and super-concentrators. *J. Combin. Theory Ser. B*, 38 (1985), 73–88.
- [5] D. Arthur, B. Manthey, and H. Röglin, k-means has polynomial smoothed complexity, in *Proc. of the 50th FOCS (Atlanta, USA)*, pp. 405–414, 2009.
- [6] J. Baston, D. Spielman, and N. Srivastava, Twice-Ramanujan sparsifiers, STOC 2009.

-
- [7] R. Beier and B. Vöcking, Typical properties of winners and losers in discrete optimization, in *STOC '04: the 36th Annual ACM Symposium on Theory of Computing*, pp. 343–352, 2004.)
- [8] K. H. Borgwardt, *The Simplex Method, a Probabilistic Analysis*, Algorithms and Combinatorics 1, Springer-Verlag, Berlin, 1987.
- [9] K. L. Clarkson, A Las Vegas algorithm for linear programming when the dimension is small, *J. ACM* **42**(2) (1995) 488–499.
- [10] G. B. Dantzig, *Linear Programming and Extensions*, Princeton University Press, Princeton, N.J., 1963.
- [11] J. Dunagan, D. A. Spielman, and S.-H. Teng, Smoothed analysis of condition numbers and complexity implications for linear programming, *Mathematical Programming*, Series A, 2009. To appear.
- [12] M. Elkin, Y. Emek, D. Spielman, and S.-H. Teng, Lower-stretch spanning trees, *SIAM Journal on Computing*, Vol 32 (2008), 608–628.
- [13] S. Hoory, N. Linial and A. Wigderson, Expander graphs and their applications, *Bull. Amer. Math. Soc.*, 43 (2006), 439–561.
- [14] R. G. Gallager, *Low Density Parity Check Codes*, MIT Press, Cambridge, MA, 1963.
- [15] M. Grötschel, L. Lovász, and A. Schrijver, *Geometric Algorithms and Combinatorial Optimization*, volume 2 of Algorithms and Combinatorics. Springer-Verlag, Berlin, second edition, 1993.
- [16] M. Jerrum and A. Sinclair, Approximate counting, uniform generation and rapidly mixing Markov chains. *Inform. and Comput.*, 82 (1989), 93–133.
- [17] J. Justesen, A class of constructive asymptotically good algebraic codes, *IEEE Trans. Information Theory* 18 (1972), 652–656.
- [18] L. G. Khachiyan, A polynomial algorithm in linear programming, *Soviet Math. Doklady*, 20 (1979), 191–194.
- [19] G. Kalai, A subexponential randomized simplex algorithm, *Proceedings of the 24-th Ann. ACM symp. on the Theory of Computing*, pp. 475–482, ACM Press, Victoria, 1992.
- [20] N. Karmarkar, A new polynomial time algorithm for linear programming, *Combinatorica*, 4 (1984), 373–397.
- [21] R. Kannan, S. Vempala, and A. Vetta, On clustering: Good, bad, and spectral, *J. ACM*, 51 (2004), 497–515.
- [22] G. Kalai and D. J. Kleitman, A quasi-polynomial bound for diameter of graphs of polyhedra, *Bull. Amer Math. Soc.* 26 (1992), 315–316.
- [23] J. Kelner and D.A. Spielman, A randomized polynomial-time simplex algorithm for linear programming, *Proceedings of the 38th annual ACM symposium on Theory of computing.* 2006
- [24] V. Klee and G.J. Minty, How good is the simplex algorithm, in: *Inequalities III*, O. Shisha (ed.) Academic Press, New-York, 1972, pp. 159–175.
- [25] I. Koutis, G. Miller, and R. Peng, Approaching optimality for solving SDD systems, *FOCS* 2010.

-
- [26] M. Krivelevich, B. Sudakov, and P. Tetali, On smoothed analysis in dense graphs and formulas, *Random Struct. Algorithms* 29 (2005), 180–193.
- [27] R. J. Lipton, and R. E. Tarjan, A separator theorem for planar graphs, *SIAM J. Appl. Math.* 36 (1979), 177–189.
- [28] A. Lubotzky, R. Phillips, and P. Sarnak. Ramanujan graphs, *Combinatorica*, 8 (1988), 261–277.
- [29] M. G. Luby, M. Mitzenmacher, M. A. Shokrollahi, and D. A. Spielman, Efficient erasure correcting codes, *IEEE Transactions on Information Theory*, 47 (2001), 569–584.
- [30] B. Ma, Why greed works for shortest common superstring problem, *Theor. Computer Science* 410 (2009), 5374–3975.
- [31] G. A. Margulis, Explicit constructions of graphs without short cycles and low density codes, *Combinatorica*, 2 (1982), 71–78.
- [32] N. Megiddo, Toward a genuinely polynomial algorithm for linear programming, *SIAM J. Comp.* 12 (1983), 347–353.
- [33] N. Megiddo, Linear programming in linear time when the dimension is fixed, *J. Assoc. Comp. Mach.* 31 (1984), 114–127.
- [34] J. Matoušek, M. Sharir and E. Welzl, A subexponential bound for linear programming, *Proc. 8-th Annual Symp. on Computational Geometry*, 1992, pp. 1–8.
- [35] J. Renegar, Condition numbers, the barrier method and the conjugate gradient method, *SIAM Journal on Optimization* 6, 879–912 (1996).
- [36] F. Santos, A counterexample to the Hirsch conjecture, preprint 2010, arXiv:1006.2814.
- [37] A. Schrijver, *Theory of Linear and Integer Programming*, Wiley-Interscience 1986.
- [38] S. Smale, On the average number of steps in the simplex method of linear programming, *Mathematical Programming*, 27 (1983), 241–262.
- [39] S. Smale, Mathematical problems for the next century, *Mathematics: frontiers and perspectives*, pp. 271-294, American Mathematics Society, Providence, 2000.
- [40] D. A. Spielman, Linear-time encodable and decodable error-correcting codes. *IEEE Trans. Inform. Theory*, 42 (1996), 1723–1731.
- [41] D. A. Spielman, Algorithms, graph theory, and linear equations, *Proceedings of the International Congress of Mathematicians*, 2010
- [42] D. A. Spielman and N. Srivastava, Graph sparsification by effective resistances, *SIAM J. on Computing*, to appear.
- [43] D. Spielman and S.-H. Teng, Smoothed analysis of algorithms, *Proceedings of the International Congress of Mathematicians*, vol I, pp. 597-606. Beijing 2002.
- [44] D. Spielman and S.-H. Teng, Smoothed analysis of algorithms: why the simplex algorithm usually takes polynomial time, *Journal of the ACM*, 51 (2004), 385–463.
- [45] D. Spielman and S.-H. Teng, Spectral partitioning works: planar graphs and finite element meshes *Linear Algebra and its Applications* 421 (2007), 284–305.

-
- [46] D. Spielman and S.-H. Teng, Nearly-linear time algorithms for preconditioning and solving symmetric, diagonally dominant linear systems, preprint 2006.
 - [47] D. Spielman and S.-H. Teng, Spectral sparsification of graphs, preprint, <http://arxiv.org/abs/0808.4134>.
 - [48] D. Spielman and S.-H. Teng, Smoothed analysis: an attempt to explain the behavior of algorithms in practice, *Comm. of the ACM*, 52 (2009), no. 10 pp. 76–84.
 - [49] M. Sipser and D. A. Spielman, Expander codes, *IEEE Trans. Inform. Theory*, 42 (1996), 1710–1722.
 - [50] E. Tardos, A strongly polynomial algorithm to solve combinatorial linear programs, *Oper. Res.*, 34 (1986), 250–256.
 - [51] T. Tao, and V. H. Vu, The condition number of a randomly perturbed matrix. In *STOC '07: the 39th Annual ACM Symposium on Theory of Computing* (2007), 248–255.
 - [52] M. J. Todd, Polynomial expected behavior of a pivoting algorithm for linear complementarity and linear programming problems, *Math. Prog.* 35 (1986), 173–192.
 - [53] M. J. Todd, The many facets of linear programming, *Math. Prog.* 91 (2002), 417–436.
 - [54] J. H. van Lint, *Introduction to Coding Theory*, third edition, Graduate Texts in Mathematics, 86, Springer-Verlag, Berlin, 1999.
 - [55] R. Vershynin, Beyond Hirsch conjecture: Walks on random polytopes and smoothed complexity of the simplex method, In *Proceedings of the 47th Annual IEEE Symposium on Foundations of Computer Science* (2006), 133–142.
 - [56] G. M. Ziegler, *Lectures on Polytopes*, Graduate Texts in Mathematics **152**, Springer-Verlag, New York 1995.

Gauss Prize

Yves Meyer

Graduated from École Normale Supérieure, Paris, 1960

Ph.D., Université de Strasbourg, 1966

Positions held

Highschool teacher, 1960-1963.

Instructor at Université de Strasbourg, 1963-1966.

Professor at Université Paris-Sud, 1966-1980.

Professor at École Polytechnique, 1980-1986.

Professor at Université Paris-Dauphine, 1986-1995.

Research position at Centre National de la Recherche Scientifique (CNRS), 1995-1999.

Professor at École Normale Supérieure de Cachan, 1999-2009,

Professor Emeritus at École Normale Supérieure de Cachan, 2009 -.

The work of Yves Meyer

Ingrid Daubechies*

Abstract

Yves Meyer has made numerous contributions to mathematics, several of which will be reviewed here, in particular in number theory, harmonic analysis and partial differential equations.

His work in harmonic analysis led him naturally to take an interest in wavelets, when they emerged in the early 1980s; his synthesis of the advanced theoretical results in singular integral operator theory, established by himself and others, and of the requirements imposed by practical applications, led to enormous progress for wavelet theory and its applications. Wavelets and wavelet packets are now standard, extremely useful tools in many disciplines; their success is due in large measure to the vision, the insight and the enthusiasm of Yves Meyer.

Keywords. Harmonic analysis, wavelets, signal analysis, images, quasicrystals, Navier-Stokes

We start by reviewing the work by Yves Meyer chronologically, after which we comment on the many ways in which his work has had an impact outside mathematics.

1. Early work: Harmonic Analysis and Number Theory (1964–1973)

Although the Mathematics Genealogy Project lists Jean-Pierre Kahane as his Ph.D. advisor, Yves Meyer was essentially already an independent researcher when he wrote his PhD thesis, in which he solved a problem raised by Lennart Carleson about “strong Ditkin sets” [1].

After his Ph.D., Meyer moved on to number theory, more precisely to Diophantine approximations. One of his early results was the construction of an

*218 Fine Hall, Princeton University, Washington Road, Princeton NJ 08540, USA.
E-mail: ingrid@math.princeton.edu

increasing sequence of integers $(k_n)_{n \in \mathbb{N}}$ such that for any $t \in \mathbb{R}$, the sequence $(t k_n)_{n \in \mathbb{N}}$ is equidistributed *modulo* 1 if and only if t is transcendental [2]. This result precluded the characterization by Gérard Rauzy of normal sets. Meyer also became interested in Pisot numbers and found a new approach to a theorem by Raphaël Salem and Antoni Zygmund concerning sets of uniqueness of trigonometric expansions, proving in particular that certain types of Cantor sets have the property of spectral synthesis.

Insights gained while working on these early results then led to the first major contribution of Yves Meyer: the theory of *model sets*, which paved the road to the mathematical theory of *quasicrystals*.

A set $\Lambda \subset \mathbb{R}^n$ is a model set if it is *uniformly discrete* (i.e. $\exists r > 0$ such that $\forall \lambda \neq \lambda' \in \Lambda, |\lambda - \lambda'| \geq r$) and if there exist a finite set $F \subset \mathbb{R}^n$ and a constant $C > 0$ such that (1) $\Lambda - \Lambda \subset \Lambda + F$, and (2) $\inf_{\lambda \in \Lambda} |x - \lambda| \leq C$ for all $x \in \mathbb{R}^n$. Meyer proved the following theorem: if Λ is a model set and if $\theta \Lambda \subset \Lambda$ then θ is a Pisot or a Salem number. The following converse is also true: for each Pisot or Salem number, there exists a model set Λ such that $\theta \Lambda \subset \Lambda$. This and many other properties of model sets are established in [3], relating them to the theory of mean-periodic functions developed by Jean Delsarte and Jean-Pierre Kahane. It was later realized that some non-periodic patterns observed in chemical alloys, now generally known as quasicrystals, could be identified with specific model sets. It is worth noting that these fundamental discoveries by Yves Meyer predated the first constructions of Penrose tilings.

2. Singular Integral Operators: the Calderón Program (1974–1984)

Alberto Calderón proposed to construct an improved pseudodifferential calculus, with minimal smoothness assumptions on the “symbol”; he introduced this generalization so as to

obtain stronger estimates and to prepare the ground for application to the theory of quasilinear and nonlinear differential operators.

In particular, these new operators had to include *singular integral operators*, of which the archetypical examples are the *Hilbert transform* H (in one dimension),

$$H(f)(x) = \frac{1}{\pi} \lim_{\epsilon \rightarrow 0} \int_{y \in \mathbb{R}, |x-y| > \epsilon} \frac{1}{x-y} f(y) dy ,$$

and the *Riesz transforms* R_i (in higher dimensions),

$$R_i(f)(x) = \frac{1}{\pi \omega_{n-1}} \lim_{\epsilon \rightarrow 0} \int_{y \in \mathbb{R}^n, |x-y| > \epsilon} \frac{x_i}{|x-y|^{n+1}} f(y) dy ,$$

where ω_{n-1} is the volume of the unit ball in \mathbb{R}^n , $n > 1$. More generally, a singular integral operator T in Calderón-Zygmund theory is associated with a kernel function $K : \mathbb{R}^n \times \mathbb{R}^n \rightarrow \mathbb{R}$ in the following way:

for arbitrary smooth functions f, g , both compactly supported, and with disjoint supports,

$$\int_{\mathbb{R}^n} g(x) T(f)(x) dx = \int_{\mathbb{R}^n} \int_{\mathbb{R}^n} g(x) K(x, y) f(y) dy dx ,$$

where K must satisfy some decay and cancellation conditions that nevertheless allow singular behavior of $K(x, y)$ as y approaches x . (More precisely, the decay conditions require that $|x - y|^{-n} |K(x, y)|$ be uniformly bounded, and that, for some $\delta > 0$, and some $C \in \mathbb{R}_+$, $[\min(|x - y|, |x' - y|)]^n |K(x, y) - K(x', y)| \leq C \left(\frac{|x - x'|}{|x - y| + |x' - y|} \right)^\delta$, again uniformly in x, x' and y for $x \neq y \neq x'$, with a symmetric condition on $K(x, y) - K(x, y')$. The cancellation conditions exist in several versions, and are more subtle.)

The most famous examples of such operators are given by the Cauchy integral on a Lipschitz curve or the double layer potential on a Lipschitz surface. Together with Ronald Coifman and Alan McIntosh, Yves Meyer [4] obtained a breakthrough result in this framework, proving the boundedness of these Calderón-Zygmund operators for arbitrary Lipschitz curves or surfaces. This breakthrough opened the door for further fundamental results, such as the solution of the Dirichlet problem in arbitrary Lipschitz domains by the method of layer potentials [5], the celebrated $T(1)$ theorem of Guy David [6], proving boundedness of general Calderón-Zygmund operators under minimal conditions (generalized even further by David, Journé and Semmes [7]), and the solution of Kato's conjecture about the square root of accretive differential operators [8].

One of the technical tools used repeatedly in the analysis of Calderón-Zygmund operators consists in integral formulas of the type

$$Q_s(f)(x) = s^n \int_{\mathbb{R}^n} f(x - y) q(sy) dy ,$$

with a function $q : \mathbb{R}^n \rightarrow \mathbb{R}$ defined in several ways in different papers, one of the easiest of which is $q(x) = 2^n \varphi(2x) - \varphi(x)$, for some well-localized and smooth "bump function" φ on \mathbb{R}^n (i.e. a smooth function with fast decay and integral 1), often picked radially symmetric for simplicity. One then easily checks that the following resolution of the identity holds, at least in the weak sense, and for reasonable f ,

$$\int_0^\infty Q_s(Q_s(f)) \frac{ds}{s} = C_\varphi f ,$$

where C_φ depends on the choice of φ , but not on f . The integral over the scaling parameter s can then be written as a sum of integrals over subsets of \mathbb{R}_+ , carving up f into components at different scales.

3. Signal and Image Processing: Wavelets (1983–1993)

Wavelet theory finds its origin in the recurrent need to develop a localized version of Fourier analysis, inasmuch as is possible within the Heisenberg principle constraint.

Early attempts to obtain *time-frequency representations* for arbitrary (bounded) functions $f : \mathbb{R} \rightarrow \mathbb{C}$, via linear and bilinear transforms, were motivated at least in part by the desire to study the correspondence between classical and quantum mechanics: coherent state representations (already implicit in some of Schrödinger's work; introduced more explicitly by Gabor in 1945) which can be viewed as *short-time Fourier transforms* or *windowed Fourier transforms*,

$$S_w(f)(t, \omega) = \int_{\mathbb{R}} f(t + \tau) e^{i\omega\tau} w(\tau) d\tau$$

(where w is typically smooth and has compact support or fast decay), or the Wigner transform,

$$W(f, g)(t, \omega) = \int_{\mathbb{R}} f(t + \tau) \overline{g(t - \tau)} e^{2i\omega\tau} d\tau ;$$

in this last case, $W(f, f)$ (in which $g = f$) is called the Wigner or Wigner-Ville distribution of f , first introduced in the 1930s. Figure 1 illustrates these time-frequency representations for one particular f .

In the windowed Fourier transform the extent of “time” or “frequency” localization is fixed in advance by the choice of the window function w . For instance, in Figure 1, the constant frequency component f_1 is clearly delineated in the windowed Fourier transform with wide window w_{wide} , and much less so when w_{narrow} is chosen; on the other hand, the temporal start of f_2 can be identified with greater accuracy in the windowed Fourier transform with w_{narrow} than with w_{wide} . One easily checks that, for a wide range of choices of f, g , including all $f, g \in L^2(\mathbb{R})$,

$$\int_{\mathbb{R} \times \mathbb{R}} \overline{S_w(g)(t, \omega)} S_w(f)(t, \omega) dt d\omega = 2\pi \left[\int_{\mathbb{R}} |w(s)|^2 ds \right] \int_{\mathbb{R}} \overline{g(\tau)} f(\tau) d\tau ;$$

writing out explicitly the integrals in $S_w(g)$, one finds that this can be interpreted (in the weak sense) as

$$f(\tau) = (2\pi)^{-1} \int_{\mathbb{R} \times \mathbb{R}} S_w(f)(t, \omega) w(\tau - t) e^{-i\omega\tau} dt d\omega ,$$

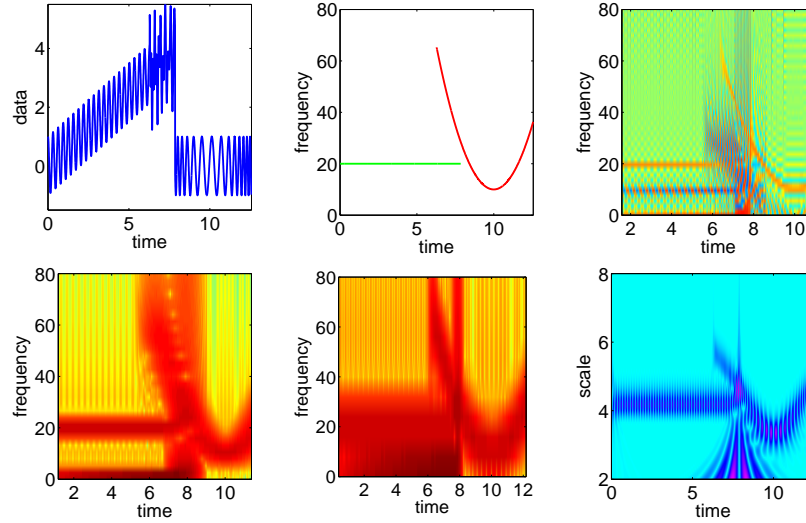

Figure 1. **Examples of time-frequency representations.** Top row left: the signal $f(t) = f_1(t) + f_2(t)$ defined by $f_1(t) = .5t + \cos(20t)$ for $0 \leq t \leq 5\pi/2$, and $f_2(t) = \cos(\frac{4}{3}[(t-10)^3 - (2\pi-10)^3] + 10(t-2\pi))$ for $2\pi \leq t \leq 4\pi$; middle: the “instantaneous frequency” for its two components: for f_1 , $\omega(t) = 20$ for $0 \leq (t-10)^2 \leq 5\pi/2$, and for f_2 , $\omega(t) = 4t^2 + 10$ for $2\pi \leq t \leq 4\pi$; right: the Wigner-Ville distribution of f . Bottom row left: the (absolute value of a) continuous windowed Fourier transform of $f(t)$, with a window w_{wide} with a wide (compact) support in t ; middle: same, but now with a window w_{narrow} with a less wide (compact) support in t ; right: the (absolute value of a) continuous wavelet transform of $f(t)$, where ψ is the Morlet wavelet (essentially a modulated Gaussian).

The quadratic nature (in f) of the Wigner-Ville distribution causes “interference” terms in the time-frequency representation, avoided in linear time-frequency methods such as the windowed Fourier transforms.

The two windowed Fourier transforms show how the choice of the window influences the corresponding time-frequency representation; in the wavelet transform the fine scale at high frequencies, and the wider time support at lower frequencies make it possible to identify both the frequency of f_1 and the onset of f_2 with greater accuracy than in either of the windowed Fourier transform representations.

where we assume $\int_{\mathbb{R}} |w(s)|^2 ds = 1$ for simplicity. With judicious choices of the window w and of parameters t_0, ω_0 , there exist similar *decomposition formulas* using discrete sums rather than integrals, i.e.

$$f(\tau) = (2\pi)^{-1} \sum_{m,n \in \mathbb{Z}} S_w(f)(m t_0, n \omega_0) w(\tau - m t_0) e^{-i n \omega_0 \tau} .$$

The Gabor transform is exactly of this type, with a Gaussian window w . These integrals or sums can be viewed as ways to write f as a superposition of “atoms” $w_{[t,\omega]}(\tau) := w(\tau - t) e^{-i\omega\tau}$ that are each well localized in time and frequency around their label $[t, \omega]$; note that each $w_{[t,\omega]}$ is obtained from the “generating”

atom w by simple translation in time and in frequency. These decompositions suffer, however, from the shortcoming illustrated by Figure 1: the choice of the window fixes the trade-off between precision in time and frequency localization, which then remains the same throughout the time-frequency plane.

This shortcoming led Jean Morlet, a seismological engineer, to introduce a new integral transform based on time-scale atoms, generated by translates and *dilates* of an atom ψ , i.e. $\psi^{[a,t]}(\tau) := N_a \psi\left(\frac{\tau-t}{a}\right)$, where the normalization constant N_a can be adapted to the application at hand; often $N_a = a^{-1/2}$ is selected, ensuring a constant $L^2(\mathbb{R})$ -norm for the $\psi^{[a,t]}$. Typically one picks ψ smooth, with fast decay; it is essential that it also satisfy $\int_{\mathbb{R}} \psi(t) dt = 0$. Analogously to the windowed or short-time Fourier transform $S_w(f)(t, \omega) = \int f(\tau) \overline{w_{t,\omega}(\tau)} d\tau$, one then defines the wavelet transform $T_\psi(f)$ by

$$T_\psi(f)(a, t) = \int_{\mathbb{R}} f(\tau) \overline{\psi^{[a,t]}(\tau)} d\tau .$$

The bottom right panel of Figure 1 illustrates that $T_\psi(f)$ does provide a time-frequency representation with high resolution in time for high frequency components, and high resolution in frequency for low frequency components.

The main theoretical properties of this transform were studied by mathematical physicist Alex Grossmann, in collaboration with Jean Morlet. They showed in particular that, in the same way as for the windowed Fourier transform, (and with the choice $N_a = a^{-1/2}$)

$$\int_{\mathbb{R} \times \mathbb{R}} \overline{T_\psi(g)(a, t)} T_\psi(f)(a, t) dt a^{-2} da = 2\pi \left[\int_{\mathbb{R}} |\xi|^{-1} |\widehat{\psi}(\xi)|^2 d\xi \right] \int_{\mathbb{R}} \overline{g(\tau)} f(\tau) d\tau,$$

where $\widehat{\psi}$ is the Fourier transform of ψ . Again, this can be interpreted as

$$f(\tau) = (2\pi)^{-1} \int_{\mathbb{R} \times \mathbb{R}} T_\psi(f)(a, t) \psi^{[a,t]}(\tau) dt a^{-2} da ,$$

with $\int_{\mathbb{R}} |\xi|^{-1} |\widehat{\psi}(\xi)|^2 d\xi = 1$ for simplicity; judicious choices of ψ and of parameters t_0, a_0 lead to a similar discrete *decomposition formula*,

$$f = (2\pi)^{-1} \sum_{m,n \in \mathbb{Z}} T_\psi(f)(a_0^n, m a_0^n t_0) \psi^{[a_0^n, m a_0^n t_0]} .$$

These decomposition formulas for f turn out to be *exactly* the same as the formula at the end of the previous section (restricted to dimension 1): the integral over the parameter s corresponds here to the integral over the dilation parameter a , and the integral over t is just an explicit writing-out of the convolution inherent to the “outer” Q_s ; the “inner” Q_s is subsumed in the wavelet transform $T_\psi(f)$.

Yves Meyer was the first to notice this similarity, and to realize that the wavelet transform proposed by Grossmann and Morlet was related to the very

rich and powerful Calderón-Zygmund theory. He soon established that, in contrast to the windowed Fourier transform, the wavelet transform allows for discrete versions in which the $\psi^{[a_0^n, m a_0^n t_0]}$ constitute an orthonormal basis for $L^2(\mathbb{R})$. Several new families of bases, constructed by Meyer and by his student Pierre-Gilles Lemarié-Rieusset, as well as by the mathematical physicist Guy Battle, soon joined the two already existing constructions, by Alfred Haar and Jan-Olov Stromberg respectively, all featuring dyadically scaled functions of the type $\psi_{j,k}(t) = 2^{j/2} \psi(2^j t - k)$, with j, k ranging over \mathbb{Z} . In collaboration with Stéphane Mallat, Meyer constructed a general framework, *multiresolution analysis*, that not only provided the right setting to construct further wavelet bases, but also allowed the seamless integration of the new wavelet point of view with the existing Calderón-Zygmund theory. In particular, Meyer showed in his celebrated book [9] that these wavelet bases are unconditional bases for a host of classical function spaces; this is a key feature in many applications of wavelets, for instance in data compression and statistical estimation.

The work of Yves Meyer paved the way to the construction of orthonormal bases of compactly supported wavelets [10] and their subsequent biorthogonal generalization [11], corresponding to subband filtering algorithms with finite filters. The biorthogonal wavelet filters of [11] were selected as the filters of choice in the JPEG2000 image compression standard, recently adopted for the digital movies presently reaching movie theaters worldwide.

Wavelets have many more applications to science and technology, including denoising algorithms, adaptive numerical approximation of PDEs, medical and astronomical imaging, turbulence and genomic analysis; a beautiful description of different perspectives can be found in the book [12] by Yves Meyer, Stéphane Jaffard and Robert Ryan. These applications are reflected by a large number of industrial patents, workshops, conference sessions and publications devoted to these applications.

In order to satisfy the requirements for an applications to astrophysics, Meyer, in collaboration with Ronald Coifman, extended the construction of wavelet bases to *wavelet packet bases*, which have since been used in numerous applications as well.

4. Navier-Stokes Equations (1994–1999)

Yves Meyer's interest in Navier-Stokes equation was inspired by a series of talks and papers by Marie Farge, as well as by a paper by Guy Battle and Paul Federbush, suggesting that wavelet transforms might yield better results than pseudo-spectral algorithms for the numerical approximation of turbulent flow. This belief was grounded by the observation that turbulence involves a cascade of energy across a large range of scales and that wavelets provide a natural tool to identify the different scales and to analyze their interaction.

This led Yves Meyer to launch a research program on the Navier-Stokes equation, in collaboration with his students Marco Cannone, Fabrice Planchon

and Pierre-Gilles Lemarié-Rieusset. It turned out that it is in fact more efficient to stick to Littlewood-Paley decompositions than to use wavelet expansions for the analysis of Navier-Stokes equations; using these decompositions they proved global existence of the solution in the space $C(\mathbb{R}_+, L^3(\mathbb{R}^3))$ when the initial condition u_0 is oscillating in the sense that it belongs to a Besov space of negative order; this was an improvement on the earlier Fujita-Kato theorem. A uniqueness result was later established by Pierre-Gilles Lemarié.

Another famous contribution of Yves Meyer to partial differential equations is an improved div-curl lemma, stating that if E and B are two square integrable vector fields such that $\nabla \cdot E$ and $\nabla \times B$ vanish, then $E \cdot B$ belongs to the Hardy space H^1 . This remarkable result, first suggested by Pierre-Louis Lions, was proved by Yves Meyer and his collaborators in [13].

5. Recent Work (2000–2008)

The results obtained by the group of Yves Meyer in nonlinear evolution equations led him to believe that there might be a functional norm governing the eventual blow-up of the solution to the Navier-Stokes equation. This endeavor ultimately led to dramatically improved Gagliardo-Nirenberg inequalities involving negative-regularity spaces, explaining why the solution of the Navier-Stokes equation does not blow up when the initial condition is oscillating. The study of these oscillatory patterns also led Yves Meyer back to the arena of image processing. A classical problem in image analysis is the separation of geometric features and texture. The algorithm proposed by Yves Meyer is based on a minimization procedure which involves the BV-norm to measure the geometric (or “cartoon”) content and a negative smoothness norm to measure the oscillatory texture. This strongly improves on a celebrated algorithm proposed by Stanley Osher and Leonid Rudin. A comprehensive mathematical synthesis explaining the role of oscillation in both nonlinear partial differential equations and image processing was given by Yves Meyer in [14].

Most recently, Yves Meyer has been active in the field of compressed sensing. This very active field studies the extent to which one can exploit the inherent low-dimensional nature of an object or feature under study, when taking measurements in a high dimensional setting, when the identity of the “active” components is unknown. Based on abstract results from functional analysis and approximation theory from the 1960s, the fundamental estimates recently garnered an explosive amount of interest, after the work of Emmanuel Candès, Terrence Tao, David Donoho and many others who constructed concrete algorithms and illustrated their promise in applications.

A fundamental limitation in most approaches was that the best results were obtained with measurement matrices generated by probabilistic methods; typically deterministic constructions are less efficient. Yves Meyer gave the first deterministic construction of an optimal sensing system, based on the theory of model sets that he introduced at the start of his career, as well as a concrete

algorithm for signal recovery from the measurements obtained by this system; in his approach the randomness is replaced by the pseudo-periodic structure generated by the model set.

6. Conclusions

The scientific life of Yves Meyer combines deep theoretical achievements in harmonic analysis, number theory, partial differential equations and operator theory, with a constant quest for a truly interdisciplinary exchange of ideas and the development of relevant and concrete applications.

This is illustrated most notably by his leading role in the development of wavelet theory, in which his research in harmonic analysis and operator theory led him naturally to the development of the computational multiscale methods that are at the heart of numerous applications of wavelets and wavelet packets in information science and technology.

His pioneering role is clear from the record. But to all his students and collaborators, Yves Meyer also stands out by other characteristics, maybe less tangible in the written record – his insatiable curiosity and drive to understand, his openness to other fields, his boundless enthusiasm and energy that inspired many young scientists, not all of them mathematicians, and the selfless generosity with which he untiringly promoted their work.

Acknowledgment

This laudator wishes to acknowledge her heavy debt to everyone, and in particular to Albert Cohen, who helped her in putting together this write-up, especially where it concerns fields in which she is far from being expert herself.

References

- [1] Y. Meyer, *Idéaux fermés de L^1 dans lesquels une suite approche l'identité*, Math. Scand. 19, 219–222, 1966.
- [2] Y. Meyer, *Nombres algébriques, nombres transcendants et répartition modulo 1*, Acta Arithmetica 16, 347–350, 1970.
- [3] Y. Meyer, *Algebraic numbers and harmonic analysis*, North Holland, New York, 1972.
- [4] R.C. Coifman, A. McIntosh and Y. Meyer, *L'intégrale de Cauchy définit un opérateur borné sur L^2 pour les courbes Lipschitziennes*, Annals of Math. 116, 361–387, 1982.
- [5] E. Fabes, *Layer potential methods for boundary value problems on Lipschitz domains*, Potential Theory Surveys and Problems, Lecture notes in Mathematics 1344, 55–80, Springer, 1988.

- [6] G. David and J.L. Journé, *A boundedness criterion for generalized Calderón-Zygmund operators*, Annals of Mathematics, 120, 371–397, 1984
- [7] G. David, J.L. Journé and S. Semmes, *Opérateurs de Calderón-Zygmund, fonctions para-accrétives et interpolation*, Rev. Mat. Iberoamericana, 1, 1–56, 1985.
- [8] P. Auscher and P. Tchamitchian, *Square root problem for divergence operators and related topics*, Astérisque, 249, 1998.
- [9] Y. Meyer, *Wavelets and operators*, vol. I, II and III, Cambridge University Press, 1992.
- [10] I. Daubechies, *Orthonormal bases of compactly supported wavelets*, Comm. Pure & Appl. Math., 41, 909–996, 1988
- [11] A. Cohen, I. Daubechies, and J.C. Feauveau, *Biorthogonal bases of compactly supported wavelets*, Comm. Pure & Appl. Math., 45, 485–560, 1992.
- [12] S. Jaffard, Y. Meyer and R. Ryan, *Wavelets, tools for sciences and technology*, SIAM, 2001.
- [13] R. Coifman, P.-L. Lions, Y. Meyer and S. Semmes, *Compensated compactness and Hardy spaces*, J. Math. Pures Appl., 247–293, 1993.
- [14] Y. Meyer, *Oscillating patterns in some nonlinear evolution equations*, Mathematical foundation of turbulent viscous flows, Lecture notes in Mathematics 1871, Springer 2006.

Chern Prize

Louis Nirenberg

Bachelor's degree from McGill University, 1945

Ph.D., New York University, 1949.

Positions held

Faculty, New York University, 1949-1999

Original members of the Courant Institute of Mathematical Sciences.

Emeritus Professor, Courant Institute of Mathematical Sciences, New York University, 1999- .

The work of Louis Nirenberg

YanYan Li*

Louis Nirenberg is one of the most outstanding analysts of the twentieth century. For more than half a century, he has been a world leader in partial differential equations – a master of inequalities and regularity theory – with fundamental contribution in geometry, complex analysis, and fluid dynamics. Nirenberg is a household name in these fields. In addition to the depth and its basic importance, his work also has enormous influence on others. In each of the last 10 years, top 15 cited papers in mathematics include at least 2 of Nirenberg's, according to the MathSciNet. Working with others has been an essential part of Nirenberg's research — more than 90% of his research are joint works.

1. Geometry

In 1953 Nirenberg published 4 papers. The first two papers ([1] and [2]) solved two long standing open problems, the Weyl problem and the Minkowski problem, in differential geometry, and, in partial differential equations, gave basic estimates to solutions of nonlinear second order elliptic equations in dimension two. His solution of the Weyl and Minkowski problem was a pioneering work in the study of geometry problems using nonlinear partial differential equations, and a milestone in global geometry. These were established in his Ph.D. thesis in 1949. He was slow in rewriting the thesis for publication. His thesis adviser was J.J. Stoker, himself a student of Heinz Hopf.

The Weyl problem, raised by H. Weyl in 1916, is the following: Given a smooth metric g of positive Gauss curvature on the sphere S^2 , is there an embedding $X : S^2 \rightarrow R^3$ such that the metric induced on S^2 by this embedding is g ? Such an embedding $(S^2, g) \rightarrow R^3$ is called isometric, and satisfies the following system of nonlinear partial differential equations:

$$\nabla_i X \cdot \nabla_j X = g_{ij}.$$

Such an isometric embedding, if it exists, is unique up to rigid motion. H. Lewy proved in 1938 the existence part under the assumption that the metric

*Department of Mathematics, Rutgers University, 110 Frelinghuysen Road, Piscataway, NJ 08854, USA. E-mail: yyli@math.rutgers.edu

g is analytic, using theorems he developed concerning analytic Monge-Ampère equations. Nirenberg gave a beautiful solution of the Weyl problem, using the method of continuity and the strong a priori estimates he established for nonlinear elliptic equations in two dimension. The Weyl problem was independently solved by A.V. Pogorelov using a different method.

Given a closed smooth strictly convex surface M in the Euclidean space R^3 , the Gauss map $\nu : M \rightarrow S^2$, mapping a point P on M to the unit outer normal of M at P , is a diffeomorphism. The Gauss curvature K_M of M , identified as a function on S^2 through ν , satisfies

$$\int_{S^2} \frac{x}{K_M(\nu^{-1}(x))} = 0,$$

where $x = (x_1, x_2, x_3)$ is the coordinate function on S^2 .

The Minkowski problem concerns the converse: Given a smooth positive function K on S^2 satisfying

$$\int_{S^2} \frac{x}{K(x)} = 0,$$

is there a closed smooth strictly convex surface M in R^3 whose Gauss curvature K_M is given by $K_M(P) = K(\nu(P))$? Nirenberg gave an affirmative answer to the question.

Consider a nonlinear partial differential equation of second order

$$F(x, u, \nabla u, \nabla^2 u) = 0 \quad \text{in } B_1,$$

where B_1 is a unit ball of R^n .

We assume that F is uniformly elliptic: F is a smooth function of its arguments satisfying, for some positive constant Λ ,

$$\frac{1}{\Lambda} |\xi|^2 \leq \frac{\partial F}{\partial M_{ij}}(x, s, p, M) \xi_i \xi_j \leq \Lambda |\xi|^2, \quad \forall \xi \in R^n, \forall (x, s, p, M).$$

A problem of basic importance is whether there exists a bound of some Hölder norm of the Hessian $\nabla^2 u$ in half of the ball in terms of the L^∞ norms of $|u|$, $|\nabla u|$ and $|\nabla^2 u|$ in B_1 . Nirenberg established such an estimate in dimension $n = 2$ as mentioned above. On the other hand, such an estimate does not hold in dimension $n \geq 12$, as shown recently by N. Nadirashvili and S. Vladut, while the problem remains open in dimension $3 \leq n \leq 11$.

With P. Hartman [11], Nirenberg studied spherical image maps where Jacobian do not change sign. In particular it was shown that if u is a real function on R^2 with the determinant of its Hessian equal to zero, then its graph is a cylinder.

Nirenberg proved in [13] rigidity of a class of surfaces in R^3 which have handles. There is still the open problem of whether a smooth closed surface in

R^3 can be deformed continuously, in an isometric way. Namely, as E. Calabi expressed it, is there Nature's accordion?

In a work with C. Loewner [24], Nirenberg solved a nonlinear problem coming from geometry which involves treating some nonlinear partial differential equations invariant under conformal or projective transformations and finding solutions which become infinite on the boundary.

There is a famous result of A.D. Alexandrov that a connected compact smooth hypersurface embedded in the Euclidean space with constant mean curvature is a sphere. With Y.Y. Li, Nirenberg proved in [57], a paper dedicated to the memory of S.S. Chern, a generalization of this, replacing the constancy by a monotonicity condition, and proving symmetry of the hypersurface about a hyperplane under some conditions. Open questions still remain, in particular, about possible extension of Hopf Lemma for elliptic operators. They also studied in [56] the regularity of the distance function to the boundary, in Finsler geometry, and applied it to the study of singular set of viscosity solutions of Hamilton-Jacobi equations.

2. Linear Partial Differential Equations

One of the 4 papers Nirenberg wrote in 1953 is [3] in which he proved the strong maximum principle for parabolic operators extending the classical results for elliptic operators. This has been a standard reference.

In 1956 Nirenberg settled in [4] a long standing open problem about regularity of elliptic boundary value problems up to the boundary. He did this for equations of arbitrary order.

Much of Nirenberg's work concerns estimates for solutions of elliptic boundary value problems. With S. Agmon and A. Douglis he gave in [10, 16] a comprehensive treatment of linear elliptic partial differential equations of any order with general boundary conditions which include the extension of Schauder and L^p theory for second order elliptic partial differential equations with Dirichlet boundary condition to this generality. These fundamental results are used every day by researchers in partial differential equations, fluid dynamics, material sciences, and many other fields.

With C.B. Morrey, Nirenberg proved in [6] the analyticity of solutions of general linear elliptic systems with analytic coefficients.

In [15], a long paper with Agmon, Nirenberg investigated solutions of ordinary differential equations in Banach space with applications to asymptotic expansion as $t \rightarrow \infty$ for solutions of elliptic equations in a cylinder. These results have been used by others as the basis for the study of elliptic equations in domains with corners: behavior of the solutions near the corners. The paper with Agmon was later generalized by A. Pazy to consider equations with coefficients depending on t . Pazy's result was used much later by H. Berestycki and Nirenberg in their study of traveling fronts in cylinder in flame propagation problems.

A basic problem in complex analysis is the so-called $\bar{\partial}$ Neumann problem. It was solved by J.J. Kohn. Nirenberg and Kohn then extended the regularity result to a wide class of noncoersive boundary value problems. This involves the loss of some derivatives. In order to do this they found it necessary to extend the Calderon-Zygmund theory of singular integral operators, to make an algebra of such operators. They introduced in [17], in 1965, the theory of pseudo-differential operators. This is a basic tool which has led to much further development in microlocal analysis and in partial differential equations. They also studied in [18] degenerate elliptic-parabolic equations.

There was a famous example by Hans Lewy of an operator of the form

$$\sum_{j=1}^3 a_j \frac{\partial u}{\partial x_j} = f \quad \text{in } R^3 \quad (1)$$

with complex coefficients $\{a_j(x)\}$, showing that there is no complex solution. The construction was motivated by complex analysis in C^2 . With Trèves [14], Nirenberg discovered the general condition under which the equation is solvable. In later work [21] and [22] they treated general linear partial differential operators and formulated a condition Φ for local solvability. For pseudo differential operators they introduced a more general condition Ψ . They proved sufficiency of Ψ in the analytic case. Sufficiency of Φ for partial differential operators was proved by R. Beals and C. Fefferman. Necessity of Ψ was proved by R.D. Moyer in dimension two and by L. Hörmander in general. Only a few years ago was sufficiency of Ψ proved by N. Dencker.

Later, Nirenberg considered again in [25] the equation (1) with $f = 0$, and constructed an operator L for which the only solution of $Lu = 0$ is $u = \text{constant}$. This gave a surprising solution to a problem of Hans Lewy. This is, as mentioned earlier, connected with complex analysis in C^2 . The corresponding question in C^{n+1} , or in R^{2n+1} , was taken up by M. Kuranishi who proved that for $n \geq 3$ the system had solutions. The case $n = 2$ is still open.

With H. Berestycki and S.R.S. Varadhan [49], Nirenberg proved the existence of principal eigenvalue (necessarily real), and derived improved form of the maximum principle for general linear second order elliptic operators in general domains. The work is considered a classic. Many people continue to refer to it.

3. Inequalities

Inequalities play a central role in almost all of Nirenberg's work. He proved basic interpolation inequalities and embedding inequalities, which are used every day.

In [9], lectures in partial differential equations, one of the lectures established general interpolation inequalities between functions and their derivatives, involving L^p spaces. These are called the Gagliardo-Nirenberg inequalities. Gagliardo derived them at the same time. These results are used all the time.

With F. John, Nirenberg introduced in [12] the space of functions of bounded mean oscillation (BMO): those are locally integrable functions f on R^n satisfying, for some constant C ,

$$\frac{1}{|B|} \int_B |f(x) - f_B| dx \leq C, \quad \text{for all balls } B,$$

where $f_B = |B|^{-1} \int_B f$ denotes the mean value of f over the ball. This is a new class of functions between L^p and L^∞ . They established a deep basic estimate for BMO functions: If f is in BMO, then u has exponential integrability, i.e., for some positive constant a ,

$$\int_B e^{a|f(x)-f_B|} dx < \infty, \quad \text{for all balls } B.$$

This seminal result has become a central element in analysis and is much used in partial differential equations, harmonic analysis, and probability theory.

With H. Brezis, Nirenberg extended in [50] and [51] degree theory to maps, between manifolds, which are merely in VMO (have vanishing mean oscillation), a refinement due to D. Sarason of the class BMO. The maps need not be continuous. The need for having a degree for such maps, with the useful properties, arose in problems coming from harmonic maps, Ginzburg-Landau equations, among others.

4. Complex Analysis

With A. Newlander, Nirenberg solved in [5] the problem on integrability of almost complex structures. In fact it was suggested to Nirenberg by A. Weil and S.S. Chern. This was a basic problem in higher dimensional complex analysis: When can one reduce a given system of n first order linear partial differential equations in R^{2n} to the Cauchy-Riemann equations in C^n , after a smooth change of coordinates? Necessary conditions were long known. Here their sufficiency was proved. This was extended by Nirenberg in [8] to a complex form of the classical Frobenius Theorem about differential forms. The Newlander-Nirenberg theorem reminds me of a meeting with S.S. Chern some years ago at the Chern Institute in Tianjin during which he gave me an envelope containing a mathematics manuscript and a letter to Nirenberg, and asked me to bring it to Nirenberg. He told me that the envelope was not sealed in case I wanted to make a copy, which I did. I remember that his whole manuscript had only two references, one of them is the paper [5].

With K. Kodaira and D. Spencer, Nirenberg proved in [7] the existence of deformation of complex structure on complex manifolds. The more general form of this result was later obtained by M. Kuranishi.

Nirenberg wrote one paper [19] with S.S. Chern (together with H.I. Levine). It introduced intrinsic norms on the homology groups of a complex manifold.

In [20] Nirenberg gave a rather simple proof of the Malgrange extension of the Weisstrass preparation theorem.

In [23] he proved an abstract form of the Cauchy-Kowalewski Theorem. This was later improved by T. Nishida, and applied to fluid dynamics.

With Caffarelli, J.J. Kohn and Spruck, Nirenberg solved in [36] the Dirichlet problem for degenerate complex Monge-Ampère equations and some uniformly elliptic ones.

5. Nonlinear Partial Differential Equations and Applications

With D. Kinderlehrer and J. Spruck, Nirenberg wrote a series of papers ([27]-[29]) on regularity of free boundaries, in the obstacle and other problems, including generalization of a result of Hans Lewy. With H. Berestycki and L. Caffarelli he wrote a deep paper [42] on uniform estimates for regularization of free boundary problem.

With B. Gidas and W.-M. Ni, Nirenberg wrote two papers [30, 32] on symmetry and monotonicity of positive solutions of various second order elliptic problems. They used the method of moving planes, due originally to A.D. Alexandrov and then used by J. Serrin. Since then, this method has found surprising applications to a wide variety of problems including derivation of a priori estimates. Later with H. Berestycki, Nirenberg gave in [45] a significant modification to the argument so that it applies to domains whose boundary maybe irregular, and also introduced the sliding method to prove monotonicity.

In all these, the maximum principle plays a crucial role. Many of Nirenberg's papers rely on the maximum principle, in one form or another. As he said, with his ever-present sense of humor, "I have made a living from the maximum principle".

Nirenberg wrote a paper with L. Caffarelli and R. Kohn in fluid dynamics [33] in 1982, on incompressible Navier-Stokes equation in three space dimensions. The equations describe the motion of an incompressible fluid in R^3 (or a domain of it), which are satisfied by unknown velocity function $u(x, t) = (u^1(x, t), u^2(x, t), u^3(x, t))$ and pressure function $p(x, t)$, defined for position $x \in R^3$ and time $t \geq 0$. They take the form (with zero external force and unit viscosity — for simplicity)

$$\frac{\partial u^i}{\partial t} + \sum_{j=1}^3 u^j \frac{\partial u^i}{\partial x_j} - \Delta u^i + \frac{\partial p}{\partial x_i} = 0, \quad x \in R^3, t \geq 0,$$

$$\sum_{i=1}^3 \frac{\partial u^i}{\partial x_i} = 0, \quad x \in R^3, t \geq 0,$$

and

$$u(x, 0) = u_0(x),$$

where $u_0(x)$ is a given smooth divergence-free vector valued function with compact support.

In order to find smooth solutions u and p , one tries to first establish the existence of solutions in weak sense and then prove regularity of weak solutions. For physically reasonable solutions, $|u|^2$ should satisfy suitable growth property.

J. Leray proved in 1934 the existence of weak solutions with suitable growth property. Nirenberg, in the joint work with Caffarelli and Kohn, proved that the 1-dimensional Hausdorff measure of the singular set of physically reasonable weak solutions, if singularities arise, is zero (so it can not contain a curve in space-time). Up to now this result has not been improved. The question of whether singularities can occur is a basic open problem in analysis and partial differential equations, and is one of the seven Clay Mathematics Institute Millennium Prize Problems.

With H. Brezis, Nirenberg proved deep existence and nonexistence results in [34] on semi-linear elliptic equations with critical exponent. This work has inspired many researchers working on problems with lack of compactness, and has led to much research activity in calculus of variations and in partial differential equations. The paper is referred to constantly. Beside this, they wrote a large number of joint papers, some are on semi-linear equation and critical point theory (e.g. [26], [31], [46] and [47], one with J.M. Coron).

With Caffarelli and Spruck, Nirenberg wrote a series of papers ([35]-[41], one with J.J. Kohn) on fully nonlinear elliptic equations, such as the Monge-Ampere equations and derived new existence theories, some with applications in differential geometry. All these papers involve deep, intricate estimates, and use the maximum principle. These works have led to much outstanding research in fully nonlinear partial differential equations.

Berestycki and Nirenberg wrote a series of papers on traveling fronts in cylinder (e.g. [43] and [44]), and with Caffarelli they wrote several papers ([48], [52], [53]-[54]) on properties of solutions of equations in unbounded domains, using the method of moving planes and the sliding method, and they obtained existence for solutions.

With Y.Y. Li, Nirenberg also wrote a large number of papers on different topics; one [55] involves estimates for elliptic systems (such as equations of elasticity) coming from composite material. With L. Caffarelli and Y.Y. Li, Nirenberg is writing a series of papers ([58]-[60]) on singular solutions of non-linear elliptic equations.

Nirenberg has shared with mathematicians all over the world his knowledge, his wisdom and his friendship. He transmitted to generations of young mathematicians his love for mathematics, gave them guidance, taught them to think and do research. He has supervised 45 Ph.D. students.

Among his many honors and awards, he received in 1959, the Bôcher Prize of the American Mathematical Society; in 1982, the Crafoord Prize which was established by the Royal Swedish Academy of Sciences in areas not covered

by the Nobel Prizes; in 1994, the Steele Prize for Lifetime Achievement of the AMS; and in 1995, the National Medal of Sciences of the United States.

We draw attention to an interview of Nirenberg [Interview with Louis Nirenberg, Notices of the AMS, April 2002], and articles on the works of Nirenberg written by L. Caffarelli and J.J. Kohn [Louis Nirenberg receives National Medal of Science, Notices of the AMS, October 1996].

References

- [1] L. Nirenberg, On nonlinear elliptic partial differential equations and Hölder continuity, *Comm. Pure Appl. Math.* 6 (1953), 103–156.
- [2] L. Nirenberg, The Weyl and Minkowski problems in differential geometry in the large, *Comm. Pure Appl. Math.* 6 (1953), 337–394.
- [3] L. Nirenberg, A strong maximum principle for parabolic equations, *Comm. Pure Appl. Math.* 6 (1953), 167–177.
- [4] L. Nirenberg, Estimates and existence of solutions of elliptic equations, *Comm. Pure Appl. Math.* 9 (1956), 509–530.
- [5] L. Nirenberg and A. Newlander, Complex analytic coordinates in almost complex manifolds, *Ann. of Math.* 65 (1957), 391–404.
- [6] L. Nirenberg and C.B. Morrey, Jr., On the analyticity of the solutions of linear elliptic systems of partial differential equations, *Comm. Pure Appl. Math.* 10 (1957), 271–290.
- [7] K. Kodaira, L. Nirenberg and D.C. Spencer, On the existence of deformations of complex analytic structures, *Ann. of Math.* 68 (1958), 450–459.
- [8] L. Nirenberg, A complex Frobenius theorem, *Proceedings of a Conference on Analytic Functions*, Princeton, Institute for Advanced Study, 1957, vol. 1, 172–189.
- [9] L. Nirenberg, On elliptic partial differential equations, *Ann. Suola Norm. Sup. Pisa* 13 (1959), 115–162.
- [10] S. Agmon, A. Douglis and L. Nirenberg, Estimates near the boundary for solutions of elliptic partial differential equations satisfying general boundary conditions. I, *Comm. Pure Appl. Math.* 12 (1959), 623–727.
- [11] P. Hartman and L. Nirenberg, On spherical image maps whose Jacobians do not change sign, *Amer. J. Math.* 81 (1959), 901–920.
- [12] F. John and L. Nirenberg, On functions of bounded mean oscillation, *Comm. Pure Appl. Math.* 14 (1961), 415–426.
- [13] L. Nirenberg, Rigidity of a class of closed surfaces, *Nonlinear Problems (Proc. Sympos., Madison, Wis., 1962)*, 177–193. University of Wisconsin Press, Madison, Wis. 1963.
- [14] L. Nirenberg and J.F. Treves, Solvability of a first order linear partial differential equations, *Comm. Pure Appl. Math.* 16 (1963), 331–357.
- [15] S. Agmon and L. Nirenberg, Properties of solutions of ordinary differential equations in Banach Spaces, *Comm. Pure Appl. Math.* 16 (1963), 121–239.

-
- [16] S. Agmon, A. Douglis and L. Nirenberg, Estimates near the boundary for solutions of elliptic partial differential equations satisfying general boundary conditions. II., *Comm. Pure Appl. Math.* 17 (1964), 35–92.
- [17] J.J. Kohn and L. Nirenberg, An algebra of pseudo-differential operators, *Comm. Pure Appl. Math.* 18 (1965), 269–305.
- [18] J.J. Kohn and L. Nirenberg, Degenerate elliptic-parabolic equations of second order, *Comm. Pure Appl. Math.* 20 (1967), 797–872.
- [19] S.S. Chern, H.I. Levine and L. Nirenberg, Intrinsic norms on a complex manifold, *Global Analysis (Papers in honor of K. Kodaira)*, 119–139. University of Tokyo Press, 1969.
- [20] L. Nirenberg, A proof of the Malgrange preparation theorem, *Lectures Notes on Singularities of Maps (C.T.C. Wall, ed.)*. Springer, 1970, 97–105.
- [21] L. Nirenberg and F. Trèves, On local solvability of linear partial differential equations. I. Necessary conditions, *Comm. Pure Appl. Math.* 23 (1970), 1–38.
- [22] L. Nirenberg and F. Trèves, On local solvability of linear partial differential equations. II. Sufficient conditions, *Comm. Pure Appl. Math.* 23 (1970), 459–509.
- [23] L. Nirenberg, An abstract form of the nonlinear Cauchy-Kowalewski theorem, *J. Differential Geometry* 6 (1972), 561–576.
- [24] L. Nirenberg and C. Loewner, Partial differential equations invariant under conformal or projective transformations, *Contributions to Analysis (dedicated to L. Bers)*, Academic Press, 1974, 245–272.
- [25] L. Nirenberg, On a question of Hans Lewy (in Russian), *Uspekhi Mat. Nauk* 29 (2) (176) (1974) (176), 241–251. English translation in *Russian Math Survey*.
- [26] H. Brezis and L. Nirenberg, Forced vibrations for a nonlinear wave equation, *Comm. Pure Appl. Math.* 31 (1978), 1–30.
- [27] D. Kinderlehrer, L. Nirenberg and J. Spruck, Régularité dans problèmes elliptiques à frontière libre, *C. R. Acad. Sci. Paris Sér. A–B* 286 (1978), A1187–A1190.
- [28] D. Kinderlehrer, L. Nirenberg and J. Spruck, Regularity in elliptic free boundary problems, *J. Analyse Math.* 34 (1978), 86–119 (1979).
- [29] D. Kinderlehrer, L. Nirenberg and J. Spruck, Regularity in elliptic free boundary problems. II. Equations of higher order, *Ann. Scuola Norm. Sup. Pisa Cl. Sci.* (4) 6 (1979), 637–683.
- [30] B. Gidas, W.-M. Ni and L. Nirenberg, Symmetry and related properties via the maximum principle, *Comm. Math. Phys.* 68 (1979), 209–243.
- [31] H. Brezis, J.M. Coron and L. Nirenberg, Free vibrations for a nonlinear wave equation and a theorem of P. Rabinowitz, *Comm. Pure Appl. Math.* 33 (1980), 667–684.
- [32] B. Gidas, W.-M. Ni and L. Nirenberg, Symmetry of positive solutions of nonlinear elliptic equations in R^n , *Mathematical analysis and applications*, Part A., 369–402, *Adv. in Math. Suppl. Stud.*, 7a, Academic Press, New York-London, 1981.
- [33] L. Caffarelli, R. Kohn and L. Nirenberg, Partial regularity of suitable weak solutions of the Navier-Stokes equations, *Comm. Pure Appl. Math.* 35 (1982), 771–832.

-
- [34] H. Brezis and L. Nirenberg, Positive solutions of nonlinear elliptic equations involving critical Sobolev exponents, *Comm. Pure Appl. Math.* 36 (1983), 437–477.
- [35] L. Caffarelli, L. Nirenberg and J. Spruck, The Dirichlet problem for nonlinear second-order elliptic equations. I. Monge-Ampere equation, *Comm. Pure Appl. Math.* 37 (1984), 369–402.
- [36] L. Caffarelli, J.J. Kohn, L. Nirenberg and J. Spruck, The Dirichlet problem for nonlinear second-order elliptic equations II: Complex Monge-Ampère, and uniformly elliptic, equations, *Comm. Pure Appl. Math.* 38 (1985), 209–252.
- [37] L. Caffarelli, L. Nirenberg and J. Spruck, The Dirichlet problem for nonlinear second-order elliptic equations. III. Functions of the eigenvalues of the Hessian, *Acta Math.* 155 (1985), 261–301.
- [38] L. Caffarelli, L. Nirenberg and J. Spruck, The Dirichlet problem for the degenerate Monge-Ampere equation, *Rev. Mat. Iberoamericana* 2 (1986), 19–27.
- [39] L. Caffarelli, L. Nirenberg and J. Spruck, Nonlinear second order elliptic equations. IV. Starshaped compact Weingarten hypersurfaces, *Current topics in partial differential equations*, 1–26, Kinokuniya, Tokyo, 1986.
- [40] L. Caffarelli, L. Nirenberg and J. Spruck, Nonlinear second-order elliptic equations. V. The Dirichlet problem for Weingarten hypersurfaces, *Comm. Pure Appl. Math.* 41 (1988), 47–70.
- [41] L. Caffarelli, L. Nirenberg and J. Spruck, On a form of Bernstein’s theorem, *Analyse mathématique et applications*, 55–66, Gauthier-Villars, Montrouge, 1988.
- [42] H. Berestycki, L. Caffarelli and L. Nirenberg, Uniform estimates for regularization of free boundary problems, *Analysis and partial differential equations*, 567–619, *Lecture Notes in Pure and Appl. Math.*, 122, Dekker, New York, 1990.
- [43] H. Berestycki and L. Nirenberg, Some qualitative properties of solutions of semilinear elliptic equations in cylindrical domains, *Analysis, et cetera*, 115–164, Academic Press, Boston, MA, 1990.
- [44] H. Berestycki and L. Nirenberg, Asymptotic behavior via the Harnack inequality, *Nonlinear analysis*, 135–144, *Sc. Norm. Super. di Pisa Quaderni*, Scuola Norm. Sup., Pisa, 1991.
- [45] H. Berestycki and L. Nirenberg, On the method of moving planes and the sliding method, *Bol. Soc. Brasil. Mat. (N.S.)* 22 (1991), 1–37.
- [46] H. Brezis and L. Nirenberg, Remarks on finding critical points, *Comm. Pure Appl. Math.* 44 (1991), 939–963.
- [47] H. Brezis and L. Nirenberg, H^1 versus C^1 local minimizers, *C. R. Acad. Sci. Paris Sér. I Math.* 317 (1993), 465–472.
- [48] H. Berestycki, L. Caffarelli and L. Nirenberg, Symmetry for elliptic equations in a half space, *Boundary value problems for partial differential equations and applications*, 27–42, *RMA Res. Notes Appl. Math.*, 29, Masson, Paris, 1993.
- [49] H. Berestycki, L. Nirenberg and S.R.S. Varadhan, The principle eigenvalue and maximum principle for second order elliptic equations in general domains, *Comm. Pure. Appl. Math.* 47 (1994), 47–93.

-
- [50] H. Brezis and L. Nirenberg, Degree theory and BMO; Part I: Compact manifolds without boundary, *Selecta Math. New Ser.* 1 (1995), 197–263.
 - [51] H. Brezis and L. Nirenberg, Degree theory and BMO; Part I: Compact manifolds with boundary, *Selecta Math. New Ser.* 2(1996), 309–368.
 - [52] H. Berestycki, L. Caffarelli and L. Nirenberg, Inequalities for second-order elliptic equations with applications to unbounded domains. I, *A celebration of John F. Nash, Jr.*, *Duke Math. J.* 81 (1996), 467–494.
 - [53] H. Berestycki, L. Caffarelli and L. Nirenberg, Monotonicity for elliptic equations in unbounded Lipschitz domains, *Comm. Pure Appl. Math.* 50 (1997), 1089–1111.
 - [54] H. Berestycki, L. Caffarelli and L. Nirenberg, Further qualitative properties for elliptic equations in unbounded domains, *Dedicated to Ennio De Giorgi*, *Ann. Scuola Norm. Sup. Pisa Cl. Sci. (4)* 25 (1997), 69–94.
 - [55] Y.Y. Li and L. Nirenberg, Estimates for elliptic systems from composite material, *Comm. Pure Appl. Math.* 56 (2003), 892–925.
 - [56] Y.Y. Li and L. Nirenberg, The distance function to the boundary, Finsler geometry, and the singular set of viscosity solutions of some Hamilton-Jacobi equations, *Comm. Pure Appl. Math.* 58 (2005), 85–146.
 - [57] Y.Y. Li and L. Nirenberg, A geometric problem and the Hopf lemma. II. *Chinese Ann. Math. Ser. B* 27 (2006), 193–218.
 - [58] L. Caffarelli, Y.Y. Li and L. Nirenberg, Some remarks on singular solutions of nonlinear elliptic equations. I., *Journal of Fixed Point Theory and Applications* 5 (2009), 353–395.
 - [59] L. Caffarelli, Y.Y. Li and L. Nirenberg, Some remarks on singular solutions of nonlinear elliptic equations. II: symmetry and monotonicity via moving planes, preprint.
 - [60] L. Caffarelli, Y.Y. Li and L. Nirenberg, Some remarks on singular solutions of nonlinear elliptic equations. III: viscosity solutions, including parabolic operators, preprint.

Proceedings of the International Congress of Mathematicians
Hyderabad, India, 2010

Exchangeability and Continuum Limits of Discrete Random Structures

David J. Aldous*

Abstract

Exchangeable representations of complex random structures are useful in several ways, in particular providing a moderately general way to derive continuum limits of discrete random structures. I shall describe an old example (continuum random trees) and a more recent example (dense graph limits). Thinking this way about road routes suggests challenging new problems in the plane.

Mathematics Subject Classification (2010). Primary 60G09; Secondary 60C05.

This write-up follows the style of the ICM talk, presented as 5 episodes in the development of a topic over the last 80 years.

- Exchangeability and de Finetti's theorem (1930s – 50s)
- Structure theory for partially exchangeable arrays (1980s)
- A general program for continuum limits of discrete random structures, illustrated by trees (1990s)
- 3 recent “pure math” developments (2000s)
- Road routes from this viewpoint (2010s)

An expanded version of the material in sections 1–4 appears as a longer survey article [4]. Section 5 is work in progress, in part with Wilfrid Kendall, not yet written up in more detail.

*Research supported by N.S.F Grant DMS-0704159.

Department of Statistics, 367 Evans Hall # 3860, U.C. Berkeley CA 94720.
E-mail: aldous@stat.berkeley.edu

1. Exchangeability and de Finetti's Theorem

A common verbal statement of de Finetti's theorem is

An infinite exchangeable sequence is distributed as a mixture of i.i.d. sequences.

For readers who don't work in Probability Theory let me try to explain what this means, starting with a very elementary story and reminding you of the jargon of random variables and probability measures.

Dice are an over-used icon for randomness; for our purpose darts (aimed at the center of a target) are better, because different people have different accuracy. So the following three scenarios, which would be mathematically equivalent for dice, are different for darts.

- Pick a person with known accuracy; ask the person to throw dart repeatedly.
- Pick a random person in audience; ask the person to throw dart 1 time. Repeat indefinitely.
- Pick a random person in audience; ask the person to throw dart repeatedly.

We are assuming a natural model for dart throwing

- For each person there is a probability measure μ on \mathbb{R}^2 ; the chance their dart lands in a region A equals $\mu(A)$.
- When this person throws repeatedly, the landing points X_1, X_2, \dots are independent random variables with distribution μ .

Recall *independence* is formalized by the *product rule*

$$P(X_1 \in A_1 \text{ and } X_2 \in A_2) = \mu(A_1) \times \mu(A_2)$$

or equivalently *product measure*

$$\text{dist}(X_1, X_2) = \mu \otimes \mu \quad \text{dist}(X_1, X_2, X_3, \dots) = \mu^{\otimes \infty}.$$

The three scenarios give three different distributions for the infinite sequence (X_1, X_2, \dots) of dart hits. With a 500-person audience with distributions $(\mu_k, 1 \leq k \leq 500)$, one of which is the known distribution μ , the distributions are

- $\mu^{\otimes \infty}$
- $\nu^{\otimes \infty}$ where $\nu(\cdot) = \frac{1}{500} \sum_k \mu_k(\cdot)$
- $\frac{1}{500} \sum_k \mu_k^{\otimes \infty}$

In the first two cases, the different throws are independent, but in the third they're not. Jargon: in the first two cases the distribution is IID (independent

and identically distributed), but the third case is a *mixture of IID*. This last notion is what arises in de Finetti's theorem.

Some measure theory background. Let me try to give an intuitive feeling for basic measure-theoretic probability terms, and a particular technical fact, neither of which is easily found in textbooks. View a probability measure (PM) as like a recipe or a plan – something you *might* do – and a random variable (RV) as an instance of actually doing it. RVs can take values in an (essentially) arbitrary space S . That is, for essentially any kind of complicated mathematical object you can imagine, then you can also imagine a *random* such object. An S -valued RV X has a *distribution* $\text{dist}(X)$, the induced PM on S . Many definitions in Probability Theory are formally about PMs but we phrase them using RVs. In particular, when we talk about symmetry properties we are talking about an underlying PM not the realizations of RVs.

Now imagine an idealized random number generator (RNG) that gives a random number ξ distributed uniformly on $[0, 1]$; repeated calls to the RNG give independent ξ_1, ξ_2, \dots . Given an arbitrary (measurable) function $f : [0, 1] \rightarrow S$ for a “nice” space S , we can use $f(\xi)$ as a S -valued RV with some distribution μ . Different f might give the same μ .

An under-emphasized Theorem in measure theory says that every μ arises as $\text{dist}(f(\xi))$ for some f . Any time we do a computer simulation of a probability model we are implicitly using this fact (if it were false then there would be measures that were in principle impossible to sample computationally). So any IID S -valued sequence can be represented as $(f_1(\xi_1), f_1(\xi_2), \dots)$ where the (ξ_1, ξ_2, \dots) – which we view as calls to a RNG – are IID uniform $[0, 1]$, and where $f_1 : [0, 1] \rightarrow S$ is some function.

The phrase “a mixture of IID S -valued sequences” means a PM on S^∞ of the form

$$\int \mu^{\otimes \infty} \Psi(d\mu), \text{ for some PM } \Psi \text{ on } \mathcal{P}(S) := \{\text{PMs on } S\}.$$

As a corollary of the representation above, any such PM has a representation as the distribution of

$$f_2(\alpha, \xi_1), f_2(\alpha, \xi_2), f_2(\alpha, \xi_3), \dots \quad (1)$$

for some function $f_2 : [0, 1] \times [0, 1] \rightarrow S$. Here α is one more independent uniform $[0, 1]$ RV. The proof of (1) relies on the insight that the action of picking a PM at random can be implemented as a function of α , because *any* random pick of any type of object can be implemented that way.

Exchangeability. A finite permutation π of $\{1, 2, 3, \dots\}$ induces a map $\tilde{\pi} : S^\infty \rightarrow S^\infty$, mapping (s_i) to $(s_{\pi(i)})$.

Definition. A PM on S^∞ is **exchangeable** if it is invariant under the action of each $\tilde{\pi}$ (with the analogous definition for finite products).

Intuitively: “a sequence of RVs is exchangeable if the order does not matter”. This is a strong symmetry condition. Note it is obvious that any (finite or infinite length) mixture of IID sequences is exchangeable. de Finetti’s theorem is the non-obvious converse.

Theorem 1 (de Finetti). *Each infinite exchangeable sequence is distributed as a mixture of IID sequences*

..... and so in particular has a **representation** in form (1).

de Finetti’s Theorem plays a conceptually fundamental role in Bayesian Statistics, which I won’t explain in this talk. The theorem appears in many first-year-graduate level probability textbooks. The next material is somewhat deeper.

2. Structure Theory for Partially Exchangeable Arrays

Write $\mathbb{N} := \{1, 2, 3, \dots\}$ and write $\mathbb{N}_{(2)}$ for the set of unordered pairs $\{i, j\} \subset \mathbb{N}$. Consider a random array

$$\mathbf{X} = (X_{\{i,j\}}, \{i, j\} \in \mathbb{N}_{(2)}).$$

(Essentially a random infinite symmetric matrix). We want to study the the *partially exchangeable* property

$$\mathbf{X} \stackrel{d}{=} (X_{\{\pi(i), \pi(j)\}}, \{i, j\} \in \mathbb{N}_{(2)}) \text{ for each finite permutation } \pi. \quad (2)$$

Because not every permutation of $\mathbb{N}_{(2)}$ is of the form $\{i, j\} \rightarrow \{\pi(i), \pi(j)\}$, this is a weaker property than exchangeability of the countable family \mathbf{X} .

We can create such a partially exchangeable array by starting with our IID uniform $[0, 1]$ RVs (ξ_1, ξ_2, \dots) and applying a function $g_2 : [0, 1]^2 \rightarrow \mathbb{R}$ which is symmetric in the sense $g_2(x, y) = g_2(y, x)$, to get

$$X_{\{i,j\}} = g_2(\xi_i, \xi_j).$$

This is the “interesting” construction of an array with the partially exchangeable property. But also there are the arrays

- with IID entries
- where all entries are the same RV.

We can combine these ideas as follows. Take a function $f : [0, 1]^4 \rightarrow S$ such that $f(u, u_1, u_2, u_{12})$ is symmetric in (u_1, u_2) , and then define

$$X_{\{i,j\}} := f(U, U_i, U_j, U_{\{i,j\}}) \quad (3)$$

where all the RVs in the families $U, (U_i, i \in \mathbb{N}), (U_{\{i,j\}}, \{i,j\} \in \mathbb{N}_{(2)})$ are IID uniform(0, 1). The array $\mathbf{X} = (X_{\{i,j\}})$ is partially exchangeable.

As with de Finetti's theorem, the converse is true but far from obvious.

Theorem 2 (Partially Exchangeable Representation Theorem). *An array \mathbf{X} which is partially exchangeable, in the sense (2), has a representation in the form (3).*

There is a (technically complicated) uniqueness property - roughly, f is unique up to measure-preserving transformations of the U 's.

The specific property (2) is really just a prototype of a whole family of "partially exchangeable" properties, and Theorem 2 is a prototype of a corresponding family of **structure theorems** for variations and specializations of (2). Such results go back to Hoover [8] and Aldous [1] and appear in the 1984 survey [2]. They were subsequently extended systematically by Kallenberg, both for arrays and analogs such as exchangeable-increments continuous-parameter processes, and rotatable matrices, during the late 1980s and early 1990s. The whole topic of representation theorems is the subject of Chapters 7–9 of Kallenberg's 2005 monograph [9]. Not only does this monograph provide a canonical reference to the theorems, but also its introduction provides an excellent summary of the topic.

The original motivation for this theory was in part "mathematically natural conjectures", in part Bayesian statistics. I won't explain the original motivation in this talk, because more recent uses are more interesting.

3. A General Program for Continuum Limits of Discrete Random Structures

This is a "general program", where "general" \neq "always works" but instead means "works in various settings that otherwise look different". Let's start with a rather obvious idea:

One way of examining a complex mathematical structure equipped with a PM is to sample IID random points and look at some form of induced substructure relating the random points

which assumes we are **given** the complex structure. In contrast, here is a less obvious idea:

We can often use exchangeability in the **construction** of complex random structures as the $n \rightarrow \infty$ limits of random finite n -element structures $\mathcal{G}(n)$.

What's the point of such an indirect method? Well, it is available for use when there's no natural way to think of each $\mathcal{G}(n)$, as n varies, as taking values in the **same** space.

To expand the idea:

Within the n -element structure $\mathcal{G}(n)$ pick k IID random elements, look at an induced substructure on these k elements – call this $\mathcal{S}(n, k)$ – taking values in some space $S_{(k)}$ that depends on k but not n . Take a limit (in distribution) as $n \rightarrow \infty$ for fixed k , any necessary rescaling having been already done in the definition of $\mathcal{S}(n, k)$ – call this limit \mathcal{S}_k . Within the limit random structures $(\mathcal{S}_k, 2 \leq k < \infty)$, the k elements are exchangeable, and the distributions are consistent as k increases and therefore can be used to **define** an infinite structure \mathcal{S}_∞ .

Where one can implement this program, the random structure \mathcal{S}_∞ will, for many purposes, serve as a $n \rightarrow \infty$ limit of the original n -element structures. Note that \mathcal{S}_∞ makes sense as a rather abstract object, via the Kolmogorov extension theorem, but in concrete cases one tries

- to identify \mathcal{S}_∞ with some more concrete construction
- to characterize all possible limits of a given class of finite structures.

3.1. Continuum random trees. Trees fit nicely into the “substructure” framework. Vertices $v(1), \dots, v(k)$ of a tree define a spanning (sub)tree. Take each maximal path $(w_0, w_1, \dots, w_\ell)$ in the spanning tree whose intermediate vertices have degree 2, and contract to a single edge of length ℓ . Applying this to k independent uniform random vertices from a n -vertex tree \mathcal{T}_n , then rescaling edge-lengths by the factor $n^{-1/2}$, gives a tree we’ll call $\mathcal{S}(n, k)$. We visualize such trees as below, vertex $v(i)$ having been relabeled as i .

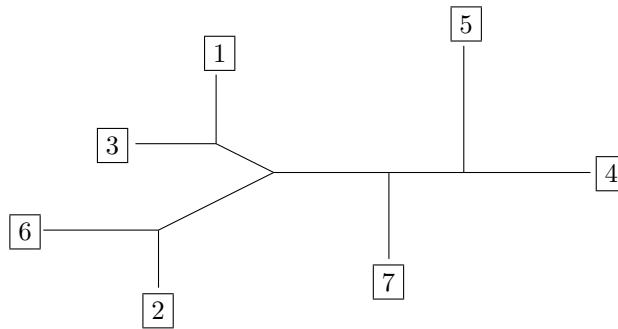

Figure 1. A leaf-labeled tree with edge-lengths. Trees are “abstract”, not embedded in \mathbb{R}^2 .

For suitable models of random n -vertex tree \mathcal{T}_n , there is a limit [3]

$$\mathcal{S}(n, k) \xrightarrow{d} \mathcal{S}(k) \text{ as } n \rightarrow \infty \text{ with fixed } k$$

with the limit distribution described below.

(i) The state space is the space of trees with k leaves labeled $1, 2, \dots, k$ and with unlabeled degree-3 internal vertices, and where the $2k - 3$ edge-lengths are positive real numbers.

(ii) For each possible topological shape, the chance that the tree has that particular shape and that the vector of edge-lengths (L_1, \dots, L_{2k-3}) is in $([l_i, l_i + dl_i], 1 \leq i \leq 2k - 3)$ equals $s \exp(-s^2/2) dl_1 \dots dl_{2k-3}$, where $s = \sum_i l_i$.

From the “sampling” construction (recall the general program) the distributions of the $\mathcal{S}(k)$ must be consistent as k varies, and so (following the general program) the family $(\mathcal{S}(k), k < \infty)$ determines a distribution of a random tree with a countable infinite number of leaves $k = 1, 2, 3, \dots$. Finally take a closure to get what is now called the (Brownian) **continuum random tree** (CRT).

In this context there is in fact a simple explicit rule (the *line-breaking construction* [3]) for how to add a new edge to $\mathcal{S}(k)$ to get $\mathcal{S}(k + 1)$, so the scheme above becomes an explicit construction.

Moreover there is an alternative general way to construct such **real (continuum) trees**, observed by Aldous [3] and Le Gall [10]. Consider a continuous excursion-type function $f : [0, 1] \rightarrow [0, \infty)$ with $f(0) = f(1) = 0$ and $f(x) > 0$ elsewhere. Use f to define a continuum tree as follows. Define a pseudo-metric on $[0, 1]$ by:

$$d(x, y) = f(x) + f(y) - 2 \min(f(u) : x \leq u \leq y), \quad x \leq y.$$

The continuum tree is the associated metric space. Applying this construction with $f =$ standard Brownian excursion (scaled by a factor 2) gives the Brownian CRT [3].

Our focus in this talk is on the initial construction – getting a limit object via induced substructures on sampled vertices – but the CRT illustrates the general goal of identifying such limit objects with more concrete representations.

4. Three Recent “pure math” Developments

Over 2004-8 there were three independent rediscoveries of the basic structure theory, motivated by “pure math” questions in different fields and leading in novel directions. I’ll say (only) a few words about each.

4.1. Isometry classes of metric spaces with probability measures.

Question: Can we characterize a “metric space with probability measure” up to measure-preserving isometry? That is, can we tell whether two such spaces (S_1, d_1, μ_1) and (S_2, d_2, μ_2) have a measure-preserving isometry?

The analog is difficult for “metric space” but easy for “metric space with probability measure”. Given (S, d, μ) , take i.i.d. (μ) random elements $(\xi_i, 1 \leq i < \infty)$ of S , form the array

$$X_{\{i,j\}} = d(\xi_i, \xi_j); \{i, j\} \in \mathbb{N}_{(2)}$$

and let Ψ be the distribution of the infinite random array. It is obvious that, for two isometric “metric spaces with probability measure”, we get the same Ψ , and the converse is a simple albeit technical consequence of the uniqueness part of structure theory, implying:

Theorem 3 (Vershik [12]). “Metric spaces with probability measure” are characterized up to isometry by the distribution Ψ .

4.2. Limits of dense graphs. Being a probabilist, I visualize the underlying “size n ” structures as being **random**, but one can actually apply our “general scheme” to some settings where they are **deterministic**. (Recall we introduce randomness via random sampling). Here’s the simplest interesting case.

Suppose that for each n there is a graph G_n on n vertices, but we don’t see the edges of G_n . See Figure 2: the \circ are the vertices. Instead of seeing all edges, we can sample k random vertices and see only the induced subgraph on the sampled vertices. In Figure 2 we sampled $k = 5$ vertices and saw which edges between them are present.

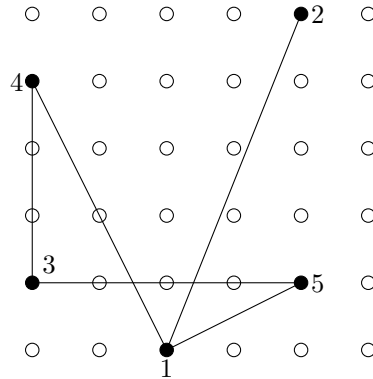

Figure 2. Induced subgraph $\mathcal{S}(n, k)$ on k of the n vertices of G_n .

One sense of “convergence” of graphs G_n is that for each fixed k the random subgraphs $\mathcal{S}(n, k)$ converge in distribution to some limit $\mathcal{S}(\infty, k)$.

This fits the “general program” setup of section 3, as follows. For each n let $(U_{n,i}, i \geq 1)$ be i.i.d. uniform on the vertex-set of G_n . Consider the infinite

$\{0, 1\}$ -valued matrix \mathbf{X}^n :

$$X_{i,j}^n = 1((U_{n,i}, U_{n,j}) \text{ is an edge of } G_n).$$

When $n \gg k^2$ the k sampled vertices $(U_{n,1}, \dots, U_{n,k})$ of G_n will be distinct and the $k \times k$ restriction of \mathbf{X}^n is the incidence matrix of the induced subgraph $\mathcal{S}(n, k)$ on these k vertices. Suppose there is a limit random matrix \mathbf{X} :

$$\mathbf{X}^n \xrightarrow{d} \mathbf{X} \text{ as } n \rightarrow \infty \quad (4)$$

in the usual product topology, that is

$$(X_{i,j}^n, 1 \leq i, j \leq k) \xrightarrow{d} (X_{i,j}, 1 \leq i, j \leq k) \text{ for each } k.$$

As background to this supposition:

- By compactness there is always a *subsequence* in which such convergence holds.
- For a non-trivial limit we need the **dense** case where $(\text{number of edges of } G_n) / \binom{n}{2} \rightarrow p \in (0, 1)$.

Now each \mathbf{X}^n has the partially exchangeable property (2), and the limit \mathbf{X} inherits this property, so we can apply the representation theorem to describe the possible limits. In the $\{0, 1\}$ -valued case we can simplify the representation. First consider a representing function of form (3) but not depending on the first coordinate – that is, a function $f(u_i, u_j, u_{\{i,j\}})$. Write

$$q(u_i, u_j) = \mathbb{P}(f(u_i, u_j, u_{\{i,j\}}) = 1).$$

The distribution of a $\{0, 1\}$ -valued partially exchangeable array of the special form $f(U_i, U_j, U_{\{i,j\}})$ is determined by the symmetric function $q(\cdot, \cdot)$, and so for the general form (3) the distribution is specified by a probability distribution over such symmetric functions.

This all fits our “general program”. From an arbitrary sequence of finite deterministic graphs we can (via passing to a subsequence if necessary) extract a “limit infinite random graph” \mathcal{S}_∞ on vertices $1, 2, \dots$, defined by its incidence matrix \mathbf{X} in the limit (4), and we can characterize the possible limits.

What is the relation between \mathcal{S}_∞ and the finite graphs (G_n) ? In probability language it’s just

the restriction \mathcal{S}_k of \mathcal{S}_∞ to vertices $1, \dots, k$ is distributed as the $n \rightarrow \infty$

$$\text{limit of the induced subgraph of } G_n \text{ on } k \text{ random vertices.} \quad (5)$$

A recent line of work in graph theory, initiated by Lovász and Szegedy [11], started by defining convergence in a more combinatorial way, by counting number of subgraphs of G_n homomorphic to fixed graphs. But this is equivalent (see Diaconis and Janson [7] for details) to our notion (5) of G_n converging

to \mathcal{S}_∞ . The structure theorem, rediscovered in this setting in [11], has subsequently been used to develop new and interesting results in graph theory, and this remains an active topic.

4.3. Further uses in finitary combinatorics. The remarkable recent survey by Austin [5] gives a more sophisticated treatment of the theory of representations of jointly exchangeable arrays, with the goal of clarifying connections between that theory and topics involving limits in finitary combinatorics.

In particular, Austin [5] describes connections with the “hypergraph regularity lemmas” featuring in combinatorial proofs of Szemerédi’s Theorem, and with the structure theory within ergodic theory that Furstenberg developed for his proof of Szemerédi’s Theorem.

Subsequently Austin and Tao [6] apply such methods to the topic of hereditary properties of graphs or hypergraphs being testable with one-sided error; informally, this means that if a graph or hypergraph satisfies that property “locally” with sufficiently high probability, then it can be modified into a graph or hypergraph which satisfies that property “globally”.

5. Continuum Spatial Random Networks

Take (say) 7 addresses in the U.S. and find (e.g. via an online map service) the road route between each pair. These routes form a sub-network of the entire U.S. road network, as illustrated in the figure.

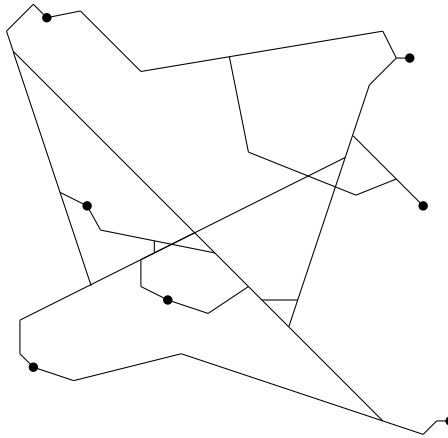

Figure 3. A subnetwork spanning 7 points of a large spatial network.

Imagine the 7 positions marked on a transparency and positioned randomly over a (real-world) road map. The sub-network (as drawn on the transparency) is

now a *random* network linking the 7 positions. *Scale-invariance* is the property that the distribution of such a subnetwork does not depend on the scale of the map, i.e. is the same whether the region in the figure has width of 10 miles or 50 miles or 250 miles. Obviously such a mathematical property cannot be exactly true for real road networks, but there is some evidence it is a reasonable approximation over scales of interest.

Question: How can we formulate the concept of a scale-invariant random spatial network (SIRSN) as a well-defined mathematical object?

A loose analogy is with (mathematical) Brownian motion, used as a model for many phenomena (physical Brownian motion, stock prices, white noise) even though its scale-invariance is not true for the real phenomenon on all scales. Analogously, in a model we want a SIRSN to be *exactly* scale-invariant. Note this forces us to work in the continuum. We will need to have routes $\mathcal{R}(z_1, z_2)$ between (almost) all pairs of points in the plane, not just between some discrete set of points. Defining such a process directly, one faces technical issues in handling an uncountable number of random variables.

The general program from section 3 suggests an alternative approach. If we were given a SIRSN then we could sample random points in the plane, precisely a Poisson point process $\Xi(\lambda)$ of mean λ per unit area, then consider the subnetwork $\mathcal{S}(\lambda)$ of routes between pairs of points in $\Xi(\lambda)$. The natural “inclusion coupling” of the point processes $(\Xi(\lambda), 0 < \lambda < \infty)$ implies an inclusion coupling of the subnetworks $(\mathcal{S}(\lambda), 0 < \lambda < \infty)$, and scale-invariance for the SIRSN implies a certain scaling property for the subnetworks.

Now the conceptual point is that we can reverse the line of thought above, and take these properties of a family $(\mathcal{S}(\lambda), 0 < \lambda < \infty)$ as the starting point for a *definition* of a SIRSN, thereby finessing the technical issues above.

5.1. Examples of SIRSNs. There seems no construction of a SIRSN that is both simple and natural, but here is the simplest artificial construction we know. Start with a square grid of roads, but impose a “binary hierarchy of speeds”: a road meeting an axis at a point $((2i + 1)2^s, 0)$ or $(0, (2i + 1)2^s)$ has speed γ^s for a parameter $1 < \gamma < 2$. Define routes between grid points to be the “shortest-time” routes. The construction is consistent under binary refinement of the lattice, so can be used to define (by continuity) routes between points in \mathbb{R}^2 , and is invariant under scaling by 2. We can obtain a process with further invariance properties by using external randomization, as follows.

- Apply large-spread random translation, take weak limits, to get translation invariance.
- Apply a random rotation to get rotation-invariance.
- Applying a random scaling with appropriate distribution on $[1, 2]$ gives full scaling invariance.

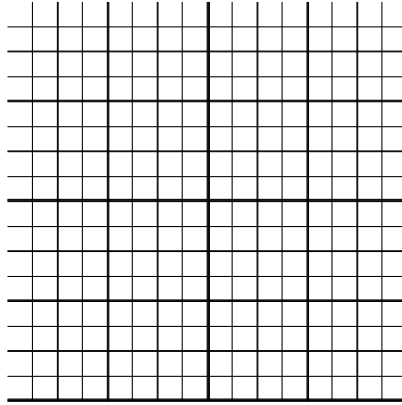

Figure 4. Thicker lines indicate faster roads.

5.2. Properties of SIRSs. Roughly speaking, we view the SIRS as the $\lambda \rightarrow \infty$ limit of the family $(\mathcal{S}(\lambda), 0 < \lambda < \infty)$ of sampled subnetworks. Here is one interesting aspect of such processes.

Let $\mathcal{E}(\lambda, r) \subset \mathcal{S}(\lambda)$ be the positions z in edges of $\mathcal{S}(\lambda)$ such that z is in the route $\mathcal{R}(\xi, \xi')$ for some points ξ, ξ' of $\Xi(\lambda)$ such that $\min(|z - \xi|, |z - \xi'|) \geq r$. In words, the road sections used in some route for which both starting and ending points are at distance at least r from the section. Let $p(\lambda, r)$ be the mean length-per-unit-area of $\mathcal{E}(\lambda, r)$. Then $\lambda \rightarrow p(\lambda, r)$ is increasing. Suppose the limit

$$p(r) := \lim_{\lambda \rightarrow \infty} p(\lambda, r)$$

is finite. Then scale-invariance implies

$$p(r) = p(1)/r, \quad 0 < r < \infty.$$

Of course $p(r)$ is the mean length-per-unit-area of $\mathcal{E}(\infty, r) := \lim_{\lambda \rightarrow \infty} \mathcal{E}(\lambda, r)$.

Now in a real world road network there is a spectrum of “sizes” of road, from “major roads” to “minor roads”. One could model a network via some specific and explicitly hierarchical model. Instead, for the general class of SIRS models we can interpret $\mathcal{E}(\infty, r)$ as the roads of “size $\geq r$ ”; the size spectrum emerges from scale-invariance without being explicitly assumed.

References

- [1] D.J. Aldous. Representations for partially exchangeable arrays of random variables. *J. Multivariate Anal.*, 11:581–598, 1981.
- [2] D.J. Aldous. Exchangeability and related topics. In *École d’Été St Flour 1983*, pages 1–198. Springer-Verlag, 1985. Lecture Notes in Math. 1117.

-
- [3] D.J. Aldous. The continuum random tree II: an overview. In M.T. Barlow and N.H. Bingham, editors, *Stochastic Analysis*, pages 23–70. Cambridge University Press, 1991.
 - [4] D.J. Aldous. More uses of exchangeability: Representations of complex random structures. In N. H. Bingham and C. M. Goldie, editors, *Probability and Mathematical Genetics: Papers in Honour of Sir John Kingman*. Cambridge University Press, 2010.
 - [5] T. Austin. On exchangeable random variables and the statistics of large graphs and hypergraphs. *Probab. Surv.*, 5:80–145, 2008.
 - [6] T. Austin and T. Tao. On the testability and repair of hereditary hypergraph properties, 2008. <http://arxiv.org/abs/0801.2179>. To appear in *Random Structures Algorithms*.
 - [7] P. Diaconis and S. Janson. Graph limits and exchangeable random graphs. *Rend. Mat. Appl. (7)*, 28(1):33–61, 2008.
 - [8] D.N. Hoover. Relations on probability spaces and arrays of random variables. Preprint, Institute of Advanced Studies, Princeton, 1979.
 - [9] O. Kallenberg. *Probabilistic Symmetries and Invariance Principles*. Springer, New York, 2005.
 - [10] J.-F. Le Gall. Brownian excursions, trees and measure-valued branching processes *Ann. Probab.*, 19:1399–1439, 1991.
 - [11] L. Lovász and B. Szegedy. Limits of dense graph sequences. *J. Combin. Theory Ser. B*, 96(6):933–957, 2006.
 - [12] A. M. Vershik. Random metric spaces and universality. *Uspekhi Mat. Nauk*, 59:65–104, 2004.

Dynamics of Renormalization Operators

Artur Avila*

Abstract

It is a remarkable characteristic of some classes of low-dimensional dynamical systems that their long time behavior at a short spatial scale is described by an induced dynamical system in the same class. The *renormalization operator* that relates the original and the induced transformations can then be iterated, and a basic theme is that certain features (such as hyperbolicity, or the existence of an attractor) of the resulting “dynamics in parameter space” impact the behavior of the underlying systems. Classical illustrations of this mechanism include the Feigenbaum-Coulet-Tresser universality in the cascade of period doubling bifurcations for unimodal maps and Herman’s Theorem on linearizability of circle diffeomorphisms. We will discuss some recent applications of the renormalization approach, focusing on what it reveals about the dynamics at typical parameter values.

Mathematics Subject Classification (2010). Primary 37E20.

Keywords. Renormalization, low-dimensional dynamics, circle diffeomorphisms, one-frequency cocycles, unimodal maps.

1. Introduction

The concept of renormalization arises in many forms through mathematics and physics. Our aim here is to discuss its incarnation as a tool in the analysis of certain classes of dynamical systems. More particularly, we will be interested in situations where renormalization gives rise to a non-trivial dynamical system in parameter space.

Inducing is a common technique to try to understand the dynamics of a map f (possibly partially defined) on some space X , restricted to a certain region $Y \subset X$. An inducing procedure gives rise to a new map g on Y which at each point coincides with some iterate of f , i.e., $g(x) = f^{n(x)}(x)$ for some positive

*CNRS UMR 7586, Institut de Mathématiques de Jussieu, 175 rue du Chevaleret, 75013, Paris, France & IMPA, Estrada Dona Castorina 110, 22460-320, Rio de Janeiro, Brasil.
E-mail: artur@math.jussieu.fr

integer $n(x)$, at each $x \in Y$ for which g is defined. The most usual choice of inducing procedure (and essentially the only one we will need to consider) is to take g simply as the first return map, so that $n(x)$ is the smallest positive integer such that $f^{n(x)}(x) \in Y$. Naturally, this induced map may look quite different from the original one.

It is a remarkable characteristic of certain classes of dynamical systems that an inducing procedure can be defined which produces maps in the same class. An example, to which we will come back to later, is the map $f(x) = 3.5x(1-x)$ on $X = [0, 1]$. The second iterate of f can be seen to restrict to a self-map of a subinterval Y around the critical point $1/2$. Both f and $g = f^2 : Y \rightarrow Y$ belong to the class of *unimodal maps* of an interval, whose distinguishing feature is the presence of a single turning point.

When an inducing procedure can be defined, acting on a certain class of dynamical systems, it can be of course iterated, which will produce a sequence of induced maps on successively smaller regions of space. A renormalization operator is defined by considering the induced dynamics after a suitable coordinate change (just affine rescaling in all situations we will consider), so that all dynamics considered occur at a fixed spatial scale. This allows the renormalization operator to have interesting dynamics in itself, e.g., it might admit a fixed point.

The actual implementation of the renormalization technique is naturally quite dependent of the systems at hand, so most of this paper will be dedicated to describing how it is applied in a few specific situations. We will focus on how features of the renormalization dynamics have concrete repercussions on the behavior or renormalized systems, and how this leads to the solution of very natural problems.

The variations in the implementation of renormalization should not mask the several underlying common themes in the cases of successful application of the renormalization approach:

1. The renormalizable dynamics is usually low-dimensional. This can be thought of as a conformality issue: in large dimensions, the distinct intrinsic scales of the different directions may be rather difficult to account for.
2. Renormalizable dynamical systems are not chaotic, i.e., iteration does not produce too much complexity. This is because each unit of time, after renormalization, represents several units of time of the original dynamics. So if the Lyapunov exponent $\lim \frac{1}{n} \ln |Df^n(x)|$, which measures the exponential rate of growth of the derivative, is positive, then it will increase under renormalization. A similar consideration applies to entropy. It is thus clear that in these situations the successive renormalizations must diverge, and no interesting renormalization dynamics can take place.
3. Renormalization of non-linear dynamical systems takes place in an infinite dimensional functional space, so identifying a renormalization attractor

plays a crucial role: it basically constrains the possibilities of the small scale behavior of the original dynamics.

4. Contrary to the renormalizable dynamics, the renormalization attractor tends to display hyperbolicity: thus renormalization acts very chaotically. A lot of the effectiveness of the renormalization approach is indeed due to the fact that moderate disorder is usually more complicated to analyze than large disorder (which, for instance, can bring into play very effective probabilistic techniques).

While our focus here will be on nonlinear maps, renormalization can also be a useful concept in the absence of nonlinearity. One example is given by interval exchange transformations, i.e., bijections of an interval I with a finite “singular set” and which restrict to translations on each interval not intersecting the singular set. Once the size of the singular set is fixed, the renormalization dynamics takes place in a finite (but large if the singular set is large) dimensional parameter space, and is related to the Teichmüller flow in moduli spaces of Abelian differentials [M], [V1], [V2]. In this case, the chaotic properties of the renormalization dynamics lead to a particularly precise stochastic modeling, and plays a key role in the description of the behavior of typical maps (see the survey [A4] and references therein). Here we will only discuss the very particular case where the singular set consists of exactly one point: in this case the interval exchange transformation gives (after gluing the extremes of the interval) a rigid rotation of the circle.

The case of rigid rotations is interesting for us since some natural classes of nonlinear dynamics can be considered as nonlinear deformations of it. Here, renormalization can be used as a way to reduce the amount of nonlinearity: in terms of the dynamics of the renormalization operator, this corresponds to showing that the finite dimensional subset of linear systems is an attractor. The analysis of the renormalization dynamics is of course much simplified by the fact that we already know from the beginning what is the “candidate attractor”, and the only problem is in establishing that it indeed attracts orbits. However, even in this simple situation, we will be able to identify an important theme, which is the key role of *a priori bounds*, or precompactness of renormalization orbits (which usually takes the form of a rough estimate on the nonlinearity). In other words, before worrying about convergence to an attractor, we should establish non-divergence.

If the nonlinearity is too large, renormalization can not hope to decrease it, and a central problem is then the construction of the attractor itself. We will discuss a recently developed approach to convergence of renormalization in such a setting, in which the attractor is produced naturally by “iteration in parameter space” (given suitable a priori bounds).

1.1. Outline of the remaining of the paper. The sections in this paper are arranged roughly according to “increasing nonlinearity”.

We start by quickly going through the case of rigid rotations in §2, as a preamble to addressing circle diffeomorphisms in §3. Our focus will be on Herman's celebrated work on linearization. Essentially, renormalization admits a global attractor corresponding to the locus of rigid rotations, and this allows one to obtain global results by reducing to the "local case" of nearly linear systems.

We next consider the setting of one-frequency cocycles, where one "adds nonlinearity" to rigid rotations through a projective extension in §4. Here a "linear attractor" still exists, but it is no longer a global one, and understanding the nature of the obstruction to convergence has important repercussions.

We then discuss a bit about the role of renormalization in the analysis of the boundary of the basin of attraction of the linear attractor §5. For one-frequency cocycles, this regards the (still poorly understood) "onset of divergence" of renormalization, while for circle diffeomorphisms one just allows for some degeneration, in the form of critical points of inflection type.

This is followed by a much more detailed treatment of the renormalization theory of unimodal maps, with a critical point of turning type, in §6, which was first developed in connection with the Feigenbaum-Couillet-Tresser universality phenomenon. A key issue we will explore is the need to construct the renormalization attractor using the renormalization dynamics itself.

Acknowledgements

I am grateful to Amie Wilkinson, Carlos Matheus and David Damanik for several suggestions.

2. Rigid Rotations

In this section, we will consider translations on \mathbb{R}/\mathbb{Z} , that is, $f(x) = x + \alpha$ where we may assume that $0 \leq \alpha < 1$. In this case, one can define a renormalization operator based on the classical continued fraction algorithm, and hence to the *Gauss map* $G(x) = \{x^{-1}\} = x - [x^{-1}]$ (where $\{\cdot\}$ and $[\cdot]$ denote, respectively, the fractional and the integer parts of a real number) as follows. Let us assume for definiteness that α is irrational, so α has an infinite continued fraction expansion

$$\alpha = \frac{1}{a_1 + \frac{1}{a_2 + \cdots}}, \quad (1)$$

with a_i positive integers. Consider also the continued fraction approximants p_n/q_n , given inductively by the formulas $p_0 = 0$, $q_0 = 1$, $p_1 = 1$, $q_1 = a_1$, and for $n \geq 2$, $p_n = a_n p_{n-1} + p_{n-2}$, $q_n = a_n q_{n-1} + q_{n-2}$. We recall that p_n/q_n approximate α from alternate sides, so that $\beta_n = (-1)^n (q_n \alpha - p_n) > 0$. Then

$\alpha_n = \beta_n/\beta_{n-1}$ are irrational numbers in $(0, 1)$ obtained by applying successively the Gauss map: $\alpha_n = G^n(\alpha)$.

The first return map to $[0, \alpha) = [0, \beta_0)$ has the form $f'(x) = x + (a+1)\alpha - 1$ for $x \in [0, \beta_1)$ and $f'(x) = x + a\alpha - 1$ on $[\beta_1, \beta_0)$. This discontinuous map on an interval can be seen as a continuous map on the circle by “gluing the extremal points” 0 and α , via the translation $x \mapsto x + \alpha$. Since the gluing map is a translation, the “new” circle has an Euclidean structure and can be identified with the original one of \mathbb{R}/\mathbb{Z} (this encodes the rescaling part of the renormalization procedure). It is easy to see that in the new coordinates the first return map is again a rigid translation by $\pm\alpha_1$, the sign depending on whether the identification does or does not reverse orientation. Here it will be most convenient to take an identification that reverses orientation, so that the renormalization of $x \mapsto x + \alpha$ is $x \mapsto x + \alpha_1$, so that the renormalization operator acting on rigid irrational translations is just the Gauss map $\alpha \mapsto G(\alpha)$ acting on the parameter space $(0, 1) \cap \mathbb{Q}$.

The Gauss map is of course a classical example of a chaotic dynamical system [Man]. It preserves the probability measure $d\mu = \frac{1}{\ln 2} \frac{dx}{1+x}$, with respect to which it has a positive Lyapunov exponent. The strong mixing properties of the Gauss map have of course many applications in the analysis of the distribution of continued fraction coefficients.

3. Diffeomorphisms of the Circle

The rigid rotations of the circle we discussed in the previous section form a finite dimensional subset in the infinite dimensional space of orientation preserving smooth diffeomorphisms of the circle. To what extent do the dynamics of nonlinear diffeomorphisms behave as a linear one?

The answer to this question begins with the combinatorial theory of Poincaré [MS]. Any orientation preserving homeomorphism of the circle f has a well defined rotation number $\rho(f)$ (defined up to an integer), which captures the speed in which orbits “go around the circle”. This is most easily defined as the reduction modulo 1 of the translation number $\lim(F^n(x) - x)/n$ of an arbitrary lift $F : \mathbb{R} \rightarrow \mathbb{R}$ of f (capturing this time the drift of F -orbits), which is readily seen to exist.¹ Notice that for a rigid rotation $f : x \mapsto x + \alpha$ we have $\rho(f) = \alpha$. For an arbitrary homeomorphism, we have:

1. f has a periodic orbit (of period q) if and only if $\rho(f)$ is rational (of the form p/q with $(p, q) = 1$). In this case, every f -orbit is asymptotic to a periodic orbit.

¹Letting m_n and M_n be the minimum and maximum of $F^n(x) - x$ for $x \in \mathbb{R}/\mathbb{Z}$ (or which is the same, for $x \in [0, 1]$, since $F^n(x+k) = F^n(x) + k$ for each $k \in \mathbb{Z}$), we see that $0 \leq M_n - m_n \leq 1$. Since m_n is superadditive and M_n is subadditive, the limits of m_n/n and M_n/n must exist and coincide.

2. If $\rho(f)$ is irrational then the orbits of f have the same combinatorial structure of the orbits of the translation $x \mapsto x + \rho(f)$: for each n , the cyclic order of $(f^k(x))_{k=0}^{n-1}$ is the same as that of $(k\rho(f))_{k=0}^{n-1}$.

We will from now on restrict our attention to the most interesting case when $\rho(f)$ is irrational. Let \mathcal{I} stand for the set of diffeomorphisms of the circle with irrational rotation number. In this case, it emerges from the combinatorial description of the orbits that there is a semi-conjugacy to the linear model, i.e., a continuous surjective map $h : \mathbb{R}/\mathbb{Z} \rightarrow \mathbb{R}/\mathbb{Z}$ satisfying $h(f(x)) = h(x) + \rho(f)$ (h is essentially unique, the only freedom available being postcomposition with arbitrary rigid rotations). The natural question is whether the orbit structure is the same also from the topological point of view: is f actually conjugated to the linear model, i.e., is h in fact a homeomorphism? This is answered quite satisfactorily by Denjoy's topological theory. At the level of homeomorphisms, it is easy to find counterexamples: one can blow up an orbit of a rigid rotation with irrational rotation number to create so-called *wandering intervals* (an interval which is disjoint of all positive iterates but does not lie in the basin of attraction of a periodic orbit). Carrying out this construction more carefully, one gets C^1 Denjoy counterexamples, but Denjoy proved that there are no C^2 Denjoy counterexamples: every C^2 diffeomorphism with irrational rotation number is topologically conjugated to a rigid rotation [MS].²

3.1. Renormalization dynamics. Recall that if f is a rigid rotation, the n -th renormalization of an irrational rotation of the circle $f : x \mapsto x + \alpha$ can be obtained by taking the first return map to an interval $[x, f^{q_n-1}(x)]$ with endpoints identified. We would like to extend this definition to an arbitrary smooth diffeomorphism with rotation number α , but we must be careful with the gluing procedure: just gluing with a translation (which generates a circle with Euclidean structure) is not natural here and will in general not produce a diffeomorphism, but only a homeomorphism. The natural way to glue is to use the dynamics itself, i.e., the map f^{q_n-1} , to generate a "smooth circle", on which the first return map indeed acts smoothly.

Unfortunately there is no canonical way to identify the smooth circle with the canonical one (\mathbb{R}/\mathbb{Z}), so this procedure does not really yield a renormalization operator acting on \mathcal{I} . This issue can be resolved by considering \mathbb{Z}^2 -actions as the basic object to be renormalized. Without going into details of this definition, we shall say that the renormalizations become more and more linear if after rescaling (by an affine map $[x, f^{q_n-1}(x)] \rightarrow [0, 1]$), both the gluing map and (each of the two smooth branches of) the first return map converge to translations (say, in the C^∞ -topology if one is dealing with smooth maps).

A simple feature of the renormalization dynamics is that since the combinatorics of the renormalized map only depend on the combinatorics of the orbits of the original one, it is clear that the rotation number transforms as for the

²See also [Y1] and [DKN] for more recent results on absence of wandering intervals.

renormalization of rigid translations, i.e., via the Gauss map. Thus renormalization can be seen as fibering over the Gauss map, and if global convergence of renormalization is established the fibers will thus be identified with *stable manifolds*. We shall see similar situations later, where the existence of a good “candidate stable manifold” will turn out to be central to the analysis of convergence in some more nonlinear situations.

Let us describe the parts of the strategy in the proof of convergence of renormalization (assuming sufficient smoothness) which are perhaps most significant in getting an idea of *why* global convergence takes place.

The first step in most proofs of convergence of renormalization involves the proof on non-divergence (in the form of establishing suitable *a priori bounds*). For circle diffeomorphisms, the crucial such bound comes from the Denjoy-Koksma inequality. It gives an estimate on distortion which implies, in particular, that Df^{q_n} is bounded for all n (this already prevents the existence of wandering intervals, and hence gives Denjoy’s Theorem on topological linearizability). It was a remarkable discovery of Herman [H1] that iteration always leads to cancellations of high order derivatives of f^{q_n} , and thus to global convergence of renormalization. After subsequent work of Yoccoz [Y2], this mechanism was understood in terms of the chain rule for the Schwarzian derivative,

$$Sf = \frac{D^3 f}{Df} - \frac{3}{2} \left(\frac{D^2 f}{Df} \right)^2, \quad (2)$$

which gives

$$Sf^n = \sum_{k=0}^{n-1} (Sf \circ f^k)(Df^k)^2. \quad (3)$$

The control of distortion coming from the Denjoy-Koksma inequality gives

$$Df^k(x) \sim C \frac{l_n(f^k(x))}{l_n(x)}, \quad 0 \leq k \leq q_n - 1, \quad (4)$$

where $l_n(y)$ is the length of the interval $[y, f^{q_n}(y)]$. This allows one to control the term $(Df^k)^2$: indeed the intervals $(f^k(x), f^{k+q_n}(x))$ are disjoint for $0 \leq k \leq q_n - 1$, so that $\sum_{k=0}^{q_n-1} l_n(f^k(x)) \leq 1$ and

$$|Sf^{q_n}(x)| \leq C \max_{0 \leq k \leq q_n-1} \frac{l_n(f^k(x))}{l_n(x)^2}, \quad (5)$$

Since the Schwarzian derivative has order 2, rescaling kills the large term $1/l_n(x)^2$. Using that $\lim_{n \rightarrow \infty} \sup_y l_n(y) = 0$ (by Denjoy’s Theorem giving topological conjugacy with irrational rotations), one gets that, after rescaling, the Schwarzian derivative of both the gluing map and the first return map is indeed going to 0.

Convergence to a linear attractor can be immediately used as a ways of “global to local” reduction. We will now discuss the most famous example of such an application.

3.2. Linearization. Let us continue our discussion of how the dynamics of circle diffeomorphisms resemble that of rigid rotations, assuming enough regularity to guarantee that f is topologically linearizable. The next step is to ask whether the *local geometry* of the orbit structure is also the same. For instance, given three nearby points in the same orbit, are the ratios between distances close to those for the rigid rotation? This (properly quantified) property is actually equivalent to C^1 -linearizability, that is, to h being a C^1 diffeomorphism.

It is easy to see that no condition on the regularity of f will be sufficient to guarantee C^1 -linearizability. Indeed, if f is any nonlinear diffeomorphism of the circle whose lifts extend holomorphically to an entire map $\mathbb{C} \rightarrow \mathbb{C}$ there exists $\theta \in \mathbb{R}$ such that $f_\theta : x \mapsto f(x) + \theta$ has irrational rotation number but is not C^1 -linearizable. This can be seen as follows:

1. $\theta \mapsto \rho(f_\theta)$ is a continuous non-decreasing map $\mathbb{R}/\mathbb{Z} \rightarrow \mathbb{R}/\mathbb{Z}$ of degree 1,
2. It follows that $\rho(f_\theta) \in \mathbb{Q}/\mathbb{Z}$ for a dense countable subset of the closure K_f of $\{\theta \in \mathbb{R}/\mathbb{Z}, \rho(f_\theta) \in \mathbb{R} \setminus \mathbb{Q}\}$.
3. If θ is such that $\rho(f_\theta) = p/q$, then every orbit of f_θ is asymptotic to one of *finitely many* periodic orbits.³ In particular,

$$\inf_{n \geq 1} \inf_{x \in \mathbb{R}/\mathbb{Z}} Df_\theta^n(x) = 0 \quad (6)$$

for any such θ .

4. A Baire category argument shows that (6) holds in fact for generic $\theta \in K_f$, which implies that f_θ is not C^1 -conjugate to a rigid translation. (Note that for generic $\theta \in K(f_\theta)$, we do have $\rho(f_\theta) \notin \mathbb{Q}/\mathbb{Z}$.)

What we wanted to highlight by giving the above argument is that in it one clearly sees that a source of trouble to C^1 -linearizability comes from “contagion” from rational rotation numbers. It turns out that positive results can be obtained if, besides regularity, one assumes that the rotation number is badly approximable by rational numbers.

3.3. The KAM Theorem. Let us consider first the *local* version of the linearizability problem, where one restricts considerations to circle diffeomorphisms close to linear. It can be attacked by a fast iteration scheme (KAM, after Kolmogorov, Arnold and Moser), first introduced by Kolmogorov in the treatment of a considerably more complicated conjugacy problem [Kol]. We will restrict ourselves to give an idea of the setup. Let us assume that we can write $f : x \mapsto x + \rho(f) + \epsilon v(x)$, with v regular and ϵ small, and let us try to solve for

³Here we use that $f_\theta^q(x) = x$ has at most finitely many solutions, which follows from the hypothesis on the holomorphic extension of the lift.

some regular conjugacy close to the identity, $h : x \mapsto x + \epsilon w(x)$ between f and some $x \mapsto x + \beta$. Writing the conjugacy equation, one gets

$$x + \rho(f) + \epsilon v(x) + \epsilon w(f(x)) = x + \epsilon w(x) + \rho(f), \quad (7)$$

i.e.

$$v(x) = w(x) - w(f(x)). \quad (8)$$

Since f is close to the translation by $\rho(f)$, it is reasonable to approximate (8) by the *cohomological equation* $v(x) = w(x) - w(x + \rho(f))$. To solve it we must assume that v has average 0 (integrate both sides), in which case a smooth solution w always exists provided v is smooth and $\rho(f)$ is *Diophantine* in the sense that rational approximations can be only polynomially good (in terms of the denominators of the continued fraction approximations, this gives $\ln q_{n+1} = O(\ln q_n)$), as can be seen by considering the Fourier series expansion. Since $f(x)$ is assumed to have rotation number exactly $\rho(f)$, it can be shown that the average of v is close to 0, so following this procedure we get an approximate solution of (8). With such a solution in hand, we can obtain an approximate conjugacy between f and the rigid translation (in this one step, we only manage to conjugate f with another nonlinear map, but which is closer to the linear model). Iterating this process again, we should obtain a sequence of conjugacies h_n between f and maps with decreasing nonlinearity, the desired conjugacy appearing only as the limit of the h_n .

We are of course skipping the core of the argument here, which is that there is loss of regularity which is apparent when solving the cohomological equation. The full treatment was given by Arnold [Ar] in the case where f is analytic (the obtained conjugacy is analytic as well in this case), the smooth case is due to Moser, see, e.g., [H1].

3.4. The Herman-Yoccoz Theorem. While the hypothesis that f be close to a rigid rotation is obviously important in the argument above, Arnold advanced the daring conjecture that his linearizability theorem should also hold in general. This later became the Herman-Yoccoz Theorem [Y2]:

Theorem 1. *Let f be a smooth (respectively, analytic) orientation preserving diffeomorphism of the circle with Diophantine rotation number. Then f is smoothly (respectively, analytically) conjugated to a rigid rotation.*

A weaker version of this theorem was first proved by Herman [H1], assuming a stricter (but still full measure) condition on the rotation number. Following the lucid account of Sullivan [S3], we will focus on this version since it is the one that illustrates most transparently the importance of convergence of renormalization (more precise results can be associated with an estimate on the *rate* of convergence), taking only a few lines. Indeed, let f be a smooth diffeomorphism with Diophantine rotation number. Its renormalizations are becoming closer and closer to rigid rotations. Assume first that the rotation

number of f is fixed by the Gauss map (for instance, it is the golden mean). Then it is clear that at some point the renormalizations belong to the “domain of convergence of the KAM algorithm”, so the renormalization will be linearizable. It follows f itself is linearizable: Since linearizability concerns the local geometry of orbits (c.f. the beginning of §3.2), it must be invariant under renormalization. In general the rotation number does change under renormalization, and while the Diophantine class is invariant under the Gauss map, the “Diophantineness” (measured in the quantification of the Diophantine condition $\ln q_{n+1} = O(\ln q_n)$) may degenerate at each step, and with it the size of the region where the KAM algorithm works. But at least for almost every rotation number, there will be infinitely many times for which the renormalized rotation numbers satisfy a fixed Diophantine condition (e.g., $\ln q_{n+1} \leq 10 \ln q_n$): this is immediate from the ergodicity of the Gauss map. For such rotation numbers, we do not need to worry about trying to hit a moving target (comparing the speed of convergence of renormalization with the possible decrease in range of the KAM method), thus global linearizability follows.

Remark 3.1. As Sullivan notes in [S3], Herman did not use the renormalization language, though his work fitted perfectly into it. The full renormalization formalism was implemented in this context by Khanin-Sinai [SK].

4. One-frequency Cocycles

We now consider a situation where renormalization presents a finite-dimensional local attracting set (again corresponding to setting the nonlinearity to zero) but which clearly can not be a global attractor. It is the precise understanding of the obstructions to convergence of renormalization that plays an important role in establishing a global theory.

4.1. The local character of linearizability in two dimensions. A few years after establishing the global nature of linearizability of diffeomorphisms of the circle satisfying suitable arithmetic conditions, Herman wrote another seminal paper [H2]. According to the title, it is about both “a method to minorate Lyapunov exponents” and “some examples showing the local character of the Arnold-Moser Theorem in dimension 2”.

The examples discussed by Herman are analytic diffeomorphisms of \mathbb{T}^2 that are isotopic to the identity, fiber over a rigid irrational rotation, and act projectively in the second coordinate. They can be written as a skew-product, or *cocycle*, $(\alpha, A) : (x, w) \mapsto (x + \alpha, A(x) \cdot w)$ where $A : \mathbb{R}/\mathbb{Z} \rightarrow \text{SL}(2, \mathbb{R})$ is an analytic map homotopic to a constant. The iterates of a cocycle have the form $(\alpha, A)^n = (n\alpha, A_n)$ with $A_n(x) = A(x + (n-1)\alpha) \cdots A(x)$. A class of particular interest consists of one-frequency Schrödinger cocycles, where

$$A = A^{(E-v)} = \begin{pmatrix} E-v & -1 \\ 1 & 0 \end{pmatrix}, \quad (9)$$

with v an analytic map $\mathbb{R}/\mathbb{Z} \rightarrow \mathbb{R}$ and E some real constant. Schrödinger cocycles are relevant to the analysis of one-frequency Schrödinger operators $H = H_{\alpha,v}$. These are bounded self-adjoint operators on $\ell^2(\mathbb{Z})$ of the form

$$(Hu)_n = u_{n+1} + u_{n-1} + v(n\alpha)u_n, \quad (10)$$

since a formal solution of $Hu = Eu$ satisfies $\begin{pmatrix} u_n \\ u_{n-1} \end{pmatrix} = A_n(0) \begin{pmatrix} u_0 \\ u_{-1} \end{pmatrix}$.

Just as for diffeomorphisms of the circle, one can define a *rotation vector* (as the reduction modulo 1 of the drift in \mathbb{R}^2 of a lift). The first coordinate of the rotation vector is obviously α , while the second is called the *fibered rotation number*. For Schrödinger cocycles, there is a beautiful reinterpretation [AS] of the fibered rotation number of $(\alpha, A^{(E-v)})$, as $1 - N(E)$ where N is the *integrated density of states* of the operator $H_{\alpha,v}$, which gives the limiting proportion of eigenvalues of restrictions of $H_{\alpha,v}$ (to intervals of increasing length) that lie in $(-\infty, E]$. In particular, for fixed v , any rotation vector (α, β) can be realized by choosing E appropriately.

In [H2], Herman discusses how the Arnold-Moser (KAM) Theorem gives a local linearization theorem in this setting: If the rotation vector satisfies a Diophantine condition then analytic linearizability holds, provided A is sufficiently close to a constant. (The use of KAM methods in connection with quasiperiodic Schrödinger operators was pioneered by Dinaburg-Sinai [DS].) On the other hand, [H2] also introduces Herman's famous "subharmonicity method" to minorate the Lyapunov exponent

$$L = \lim \frac{1}{n} \int \ln \|A_n(x)\| dx. \quad (11)$$

For Schrödinger cocycles, it implies that if v is a non-constant trigonometric polynomial $\sum_{|k| \leq m} a_k e^{2\pi i k x}$ with $|a_m| > 1$ then $L > 0$.

The positivity of the Lyapunov exponent is incompatible with even topological linearizability, since it implies in particular that the dynamics of (α, A) is not distal (if $\sup \|A_n(x)\| = \infty$ then there exist $y \neq y'$ such that $\inf d(A_n(x) \cdot y, A_n(x) \cdot y') = 0$). Thus by choosing v and E appropriately one obtains a non-linearizable cocycle which nevertheless has a Diophantine rotation vector.

Remark 4.1. Even near constants, there are *uniformly hyperbolic* cocycles, for which $\|A_n(x)\|$ grows exponentially fast uniformly on x , and in particular have positive Lyapunov exponents. The locus of uniformly hyperbolic cocycles is open and quite simple to analyze, much like the complement of the closure of circle diffeomorphisms with irrational rotation number. The examples constructed by Herman have a rather different nature, since the rotation vector of a uniformly hyperbolic cocycle is linearly dependent over the rationals. Cocycles with a positive Lyapunov exponent but which are not uniformly hyperbolic are called *nonuniformly hyperbolic*.

4.2. The basin of the renormalization attractor. Just as in the case of circle diffeomorphisms, one can try to define a renormalization operator acting on cocycles by considering the first return map to the annulus $[x_0, x_0 + q_n \alpha] \times \mathbb{R}/\mathbb{Z}$, where we identify the boundary circles via $(x, y) \mapsto (x + q_n \alpha, A_{q_n}(x) \cdot y)$. We will again omit the details of the formalized definition in terms of \mathbb{Z}^2 -actions.

As usual, if the Lyapunov exponent is positive then renormalization magnifies it, so the renormalization orbits can not converge to any attractor (recall the second theme listed in the introduction). Starting with a cocycle with Diophantine rotation vector which is sufficiently close to linear, so that the KAM Theorem applies, the successive renormalizations become increasingly linear. Thus the locus of linear cocycles behaves as a local, but not global (since it misses the Herman's examples), attractor for cocycles with Diophantine rotation vectors.⁴

What is in fact the basin of the renormalization attractor? Naturally, it is contained in the locus of zero Lyapunov exponents. Since the basin of a local attractor is by nature open, and the locus of zero Lyapunov exponents is closed (this is a deep result of Goldstein-Schlag [GoSc] and Bourgain-Jitomirskaya [BJ]), the inclusion is in fact strict. In [AK1], [AK2], it is shown that there is, however, equality “modulo 0”. For simplicity, we state the result for Schrödinger cocycles:

Theorem 2. *Let $\alpha \in \mathbb{R} \setminus \mathbb{Q}$ and $v : \mathbb{R}/\mathbb{Z} \rightarrow \mathbb{R}$ be analytic. Then for almost every $E \in \mathbb{R}$, if the Lyapunov exponent of $(\alpha, A^{(E-v)})$ is zero then the successive renormalizations of $(\alpha, A^{(E-v)})$ become increasingly linear.*

A much more detailed analysis of the “critical set” separating converging and diverging orbits of the renormalization operator has been carried out more recently as a part of a program to produce a global theory of one-frequency Schrödinger operators [A1], [A2], [A3]. It shows that (for fixed Diophantine α), the critical set is not only of zero measure, but it has zero measure *inside a codimension one subset*. This more precise description is important because the analysis of a single Schrödinger operator depends on a one-parameter family of cocycles: it allows us to make statements about *every energy E* in the spectrum of *almost every potential*.

5. Hitting the Limits of Linear Attractors

In the analysis of one-frequency cocycles, it is clear that the renormalization dynamics is not going to be governed by a nice attractor once the nonlinearity is

⁴The analysis can be extended considerably beyond Diophantine rotation vectors, but the arguments are not as simple as just applying the KAM Theorem.

so large that the Lyapunov exponent becomes positive.⁵ A more subtle problem concerns the renormalization of critical cocycles, at the onset of nonuniform hyperbolicity (see Remark 4.1). Their renormalizations can no longer converge to linear cocycles, but they could still be governed by an attractor. One reason to hope for it is the way renormalization acts on the Lyapunov exponent of complexifications: for critical cocycles one has, for $\epsilon > 0$ small,

$$\lim_{n \rightarrow \infty} \frac{1}{n} \ln \|A_n(x + \epsilon i)\| = 2\pi\omega\epsilon, \quad (12)$$

where ω is a positive integer called the acceleration (this “quantization” property was only recently discovered, in [A1]). This simple dependence behaves perfectly under renormalization, so that a renormalized critical cocycle is a critical cocycle with the same acceleration. Thus the acceleration measures an irreducible amount of nonlinearity of critical cocycles (since cocycles close to a constant must have zero acceleration), which contrary to a positive Lyapunov exponent does not grow with renormalization.

However, since it is known that if the matrix products $A_n(x)$ remain bounded for all times, then renormalization must converge to the linear attractor [AK2], it seems unrealistic to expect for renormalization to converge in the traditional sense. Maybe it might be necessary to modify the definition of the renormalization operator, perhaps by introducing nonlinear changes of coordinates? Let us note that a very different kind of renormalization mechanism [HS] has been previously considered in the analysis of some features of criticality, in the particular case of the critical Almost Mathieu Operator (with potential $v(x) = 2 \cos 2\pi x$). This especially symmetric (under so-called Aubry duality [GJS]) model has the remarkable property that the associated cocycles are critical for all energies in the spectrum, and because of (numerically) observed self-similarity in the spectrum, it is very tempting to imagine that there is a renormalization attractor somewhere in the picture. The situation here may be related to the (even less understood) breakdown of KAM behavior in area-preserving maps (discussed, e.g., in [McK]).

A similar (but much more well understood) situation concerns the case of analytic circle maps. Diffeomorphisms of the circle form an open set where renormalization acts quite nicely, but what about the *critical circle maps* in its boundary? Those are still homeomorphisms, and so have a well defined rotation number, but the critical points introduce an irreducible (conserved under renormalization) amount of nonlinearity. There is a well-developed renormalization theory in this case, particularly about the main component of the boundary of diffeomorphisms, consisting of critical circle maps with a single critical

⁵It might be still possible to obtain results describing the asymptotics of the diverging renormalization orbits, but currently there is nothing more than interesting heuristics in this direction.

point: as it turns out, there exists a renormalization attractor, and this lies behind fundamental rigidity results (see [FM1], [FM2], [Ya1], [Ya2], [KT]).⁶

If one goes beyond critical circle maps, one starts dealing with non-invertible maps of the circle. We will however go in a slightly different direction, and discuss next non-invertible maps of the interval, focusing on the particular class for which much of the renormalization theory was developed.

6. Analytic Unimodal Maps

Let $f : I \rightarrow I$ be an analytic unimodal map. Thus f has a unique critical point, which is of turning type (maximum or minimum) and located in $\text{int}I$. By an affine change of coordinates, we may normalize it so that the critical point is at the origin and $f(x) = f(0) + x^d + O(x^{d+1})$ for some even integer $d \geq 2$, called the degree. Basic examples of analytic unimodal maps are given by the (appropriate restrictions of) unicritical polynomials $x \mapsto x^d + c$ (for the suitable range of $c \in \mathbb{R}$ for which an invariant interval exists). The precise domain of definition of a unimodal map is not of too much importance, since it only concerns trivial aspects of the dynamics.

A unimodal map is called renormalizable if there is an interval $I' \subset I$ around 0 and an integer $n > 1$ such that $f^n(I') \subset I'$ but $f^j(I') \cap \text{int}I' = \emptyset$ for $1 \leq j \leq n-1$. Then $f' = f^n : I' \rightarrow I'$ is again unimodal. The set of possible values of n form a finite or infinite sequence $n_1 < n_2 < \dots$, such that $n_j | n_k$ for $j < k$. The normalization of (the appropriate restriction) of f^{n_j} is called the j -th renormalization. The renormalization operator R takes each renormalizable map f to its first renormalization Rf , and the j -th renormalization is obtained by iterating it j -times. If $R^j f$ is renormalizable for every $j \in \mathbb{N}$, f is called infinitely renormalizable.

The renormalization period of f is $n = n_1$, while the renormalization combinatorics of f is the permutation of $\pi : \{0, \dots, n-1\} \rightarrow \{0, \dots, n-1\}$ such that $\pi(j) < \pi(k)$ if and only if $f^j(0) < f^k(0)$. All integers $n \geq 2$ do arise as the renormalization periods of some unimodal map. The renormalization combinatorics is not, in general, determined by the period. We let Σ be the countable set of all possible renormalization combinatorics.

The existence of a critical point has the important consequence that all renormalizations have an “irreducible nonlinearity”. While in the situations considered in §3 and §4 we could readily define an invariant set which was a candidate to be a renormalization attractor, proving any kind of convergence

⁶Particularly Khanin-Teplinsky show (using exponential convergence of renormalization) that for analytic circle homeomorphisms with a single critical point of fixed odd degree $d \geq 3$, any two maps with the same irrational rotation number must be C^1 -conjugate. This is in stark contrast with the situation for circle diffeomorphisms, as no kind of Diophantine condition is necessary.

of renormalization for unimodal maps will involve constructing the attractor in the process.

Important aspects of the dynamics of unimodal maps are impacted by the degree, and most especially by whether $d = 2$ (the quadratic case) or $d > 2$ (the higher degree case). The ultimate source of this difference lies in a specific “decay of geometry” property valid in the quadratic case but not in the higher degree case, which diminishes the importance of nonlinearity in small scales *before the first renormalization*. This impacts, in particular, the analysis of attractors of the unimodal dynamics: in the quadratic case, Milnor’s notion of topological and measure-theoretical attractor coincide [L1],⁷ but this is not true, in general, in sufficiently high degree [BKNS].

6.1. Feigenbaum-Coulet-Tresser phenomenon. Renormalization of unimodal maps is most well known for its role in the understanding of universality in the period doubling bifurcation. Considering, say, the quadratic family $p_c(x) = x^2 + c$, which define unimodal maps for $c \in [-2, 1/4]$, one sees that for c close to $1/4$, the iterates of the critical point are asymptotic to a fixed point. This persists as one decreases the parameter c , until a moment c_0 at which the so-called saddle-node bifurcation takes place. Just below it, the fixed point becomes repelling, but a nearby period 2 cycle emerges, which still attracts the critical orbit. This again persists until another moment c_1 , where another saddle-node bifurcation takes place and a period 4-cycle emerges. Proceeding in this way, one defines the sequence of period-doubling bifurcation moments c_k (at which a 2^k -cycle gives birth to a 2^{k+1} -cycle). The remarkable fact is that c_k converges at a geometric rate, so that

$$\frac{c_k - c_{k+1}}{c_{k+1} - c_{k+2}} \rightarrow 4.669\dots \quad (13)$$

(this limit is called the Feigenbaum constant). But the big surprise is that if one considers another family of analytic unimodal maps f_c with quadratic critical point (say, close to the quadratic one, to avoid transversality issues), one gets a very different sequence of bifurcation moments \tilde{c}_k , but which still converge geometrically *with the same rate*. The Feigenbaum constant is a universal quantitative feature of the cascade of period doubling bifurcations for unimodal maps with a quadratic critical point. For fixed higher degree d , the same phenomenon occurs (with a “Feigenbaum constant” associated to each d).

Dynamics of the renormalization operator comes into play because the limiting parameter of the cascade of period doubling bifurcations corresponds to an infinitely renormalizable unimodal map f , with $n_j = 2^j$. According to

⁷By definition, an attractor should have a large *basin* (of points which are asymptotic to the attractor). If largeness is understood in terms of Baire category one gets the topological notion, while if it is understood in terms of Lebesgue measure one gets the measure-theoretical one.

the Renormalization Conjectures, advanced by Feigenbaum and Coullet-Tresser ([F], [TC]), the renormalizations $R^n f$ should converge to a universal (for each fixed degree) unimodal map f_* , a solution of the Feigenbaum-Cvitanovic equation $f_*^2(\lambda x) = \lambda f_*(x)$. Moreover, in some suitable functional space, the derivative of renormalization at f_* should be hyperbolic, and its spectrum outside the unit disk should consist of a single simple eigenvalue: In other words, f_* should be an hyperbolic fixed point with one-dimensional unstable direction. One can show that the Renormalization Conjectures imply that the cascade of period doubling bifurcations undergone by a generic (i.e., satisfying a transversality condition) family does indeed converge geometrically at a rate given precisely by the value of the eigenvalue of DRf_* which lies outside the unit disk.

There is a long history to the Renormalization Conjectures, which were initially addressed in a formal computer assisted proof of Lanford [La] (dealing with the existence and hyperbolicity of a renormalization fixed point in the quadratic case), see [L4] and references therein.

6.2. Role in the measure-theoretical analysis of parameters. While beautiful, the theory of the period doubling bifurcation only concerns the most ordered part of the dynamics of unimodal maps. Through the whole cascading process, one only faces dynamics displaying attracting periodic orbits, and only at the limit of the cascade one gets something more complicated (the attractor is no longer a periodic orbit, but the suitable limit of period 2^k -orbits, i.e., a Cantor set restricted to which the dynamics is conjugate to translation by one in the ring of 2-adic integers).

On the other side of the parameter space ($c = -2$ for the quadratic family), one gets a very different situation. The map $x \mapsto x^2 - 2$, also called the Ulam-Neumann map, possesses an invariant probability measure which is equivalent to the restriction of Lebesgue measure to $[-2, 2]$. This measure is ergodic and so Lebesgue almost every orbit is equidistributed with respect to it.

The Ulam-Neumann map shows that unimodal dynamics is consistent with chaos (the invariant measure has a positive Lyapunov exponent), but looks quite unstable. Indeed, Lyubich [L2] and Graczyk-Swiatek [GS] proved that in the quadratic family there exists an open and dense set of parameters corresponding to *regular* unimodal maps (for which the critical point is asymptotic to an attracting periodic orbit). However Jakobson [J] showed that there is a positive measure set of parameters c (near -2) corresponding to *stochastic* unimodal maps (with an absolutely continuous invariant probability measure with positive Lyapunov exponent). Thus while only regular behavior is “topologically robust”, both regular and stochastic behaviors are “measure-theoretically robust”. Such results extend to more general analytic unimodal maps, the density of regular behavior being however much harder in higher degree [KSS].

With these preliminaries, we can now present the main result on the measure-theoretic dynamics of unicritical polynomials (in the quadratic case, it is due to Lyubich [L5]).

Theorem 3 ([AL1], [AL2]). *Almost every unicritical polynomial $x^d + c$ is either regular or stochastic.*

What about infinitely renormalizable maps? Those are neither regular nor stochastic, so to get to Theorem 3 one must show in particular that infinitely renormalizable parameters correspond to a zero Lebesgue measure set of parameters.⁸ While the explanation of the Feigenbaum-Coulet-Tresser phenomenon lies in understanding the dynamics of the renormalization operator of period 2 (governed by a single hyperbolic fixed point), here we will need to understand the full renormalization dynamics, incorporating all renormalization combinatorics.

It follows from the density of regular parameters that the set of infinitely renormalizable parameters in the unicritical family (with d fixed) is homeomorphic to the set of irrational numbers in $(0, 1)$. Indeed, the combinatorics of successive renormalization behaves much like the digits in the continued fraction expansion of an irrational number: Any sequence of renormalization combinatorics is realized by a unique parameter value. This hints to the fact that “along the direction of the unicritical families” the dynamics of renormalization should resemble to some extent the shift on $\mathbb{N}^{\mathbb{N}}$.

If instead of specifying the full renormalization combinatorics one merely specify the the combinatorics of the first n renormalizations, one obtains an interval (or renormalization window) of parameters. The idea of the measure-theoretic analysis of infinitely renormalizable parameters is that the renormalization window is a distorted copy of the full parameter space. Corresponding, e.g., to the tame end of the parameter space consisting of regular dynamics, one finds accordingly a region of regular parameters inside the renormalization window. If we can control the distortion involved in the renormalization process, we will conclude that there are “definite gaps” in arbitrarily small scales around any infinitely renormalizable parameter. Thus the set of infinitely renormalizable parameters has no Lebesgue density point, and must thus have zero Lebesgue measure.

The control of the dynamics of renormalization needed in the argument lies behind a deep generalization of the Renormalization Conjectures. A program in this direction was initially advanced by Sullivan [S1] in the case of bounded combinatorics, in the sense that one restricts considerations to infinitely renormalizable maps f such that the renormalization periods of $R^k f$ is bounded (independently of k) by some fixed (but arbitrary) constant. In this setting, Sullivan [S2] (see also [MS]) constructed a global renormalization attractor (homeomorphic to the Cantor set $F^{\mathbb{Z}}$ for a finite part $F \subset \Sigma$), McMullen [McM] proved exponential convergence to the attractor, and Lyubich proved that the renormalization attractor is hyperbolic (a Smale horseshoe) with one-dimensional unstable direction [L4]. The hyperbolicity of the full renormalization operator

⁸Of course, the proof of Theorem 3 involves a substantial understanding of non-infinitely renormalizable dynamics [MN], [L3], [AKLS], [ALS], which we will not go through here.

was proved by Lyubich in the quadratic case [L5]. In this tour de force, the analysis of exponential contraction depends on special fine geometry features of the complex dynamics of quadratic polynomials [L2].

We should note that it is quite important to choose an appropriate functional setting to study the dynamics of the renormalization operator. Following Douady-Hubbard [DH], it is natural to consider the action of renormalization in spaces of *polynomial-like germs*: These may be thought of as obtained from unicritical polynomials by suitable *hybrid* deformations of the complex structure of the Riemann sphere (by Douady-Hubbard's Straightening Theorem). In this setting, the hybrid classes provide natural candidate stable manifolds of renormalization, being easily seen to be forward invariant under renormalization. Establishing that the hybrid classes are actually stable manifolds is a crucial step in the construction of the renormalization attractor.

6.2.1. Convergence of renormalization. One central point of [AL1] is that convergence along the candidate stable manifolds can be derived from *beau a priori bounds* (a concept introduced by Sullivan). This is a rough geometric control that is known to hold in general and translates to *universal precompactness* of the renormalization orbits, by exploiting the global dynamics of the renormalization operator. While it is beyond the point of this paper to discuss how the necessary a priori bounds (due to [LS] and [LY]) are obtained, we can give some ideas about how they lead to convergence.

The candidate stable manifolds can be endowed with a complex structure, which is respected by renormalization. It is important to note that we only get this complex structure by allowing deformations which are not real symmetric, and hence do not correspond to actual unimodal maps, and the beau a priori bounds only concern, in principle, the real-symmetric deformations.

The hybrid classes are all equivalent to a same functional space \mathcal{E} , hence the action of the renormalization operator along the family of all hybrid classes of infinitely renormalizable maps corresponds to the action of a certain "renormalization groupoid" \mathcal{R} acting holomorphically on \mathcal{E} . Naturally, \mathcal{R} respects the real trace $\mathcal{E}^{\mathbb{R}} \subset \mathcal{E}$ corresponding to legitimate unimodal deformations.

Using a version of the Schwarz Lemma, one obtains non-expansion of the renormalization groupoid, which together with the beau a priori bounds in $\mathcal{E}^{\mathbb{R}}$ implies that \mathcal{R} is *almost periodic*. An abstract analysis of almost periodic groupoids shows that either the renormalization groupoid is uniformly contracting or the lack of contraction is detected by a non-constant holomorphic idempotent P in its limit set $\omega(\mathcal{R})$.

We want to show that any holomorphic idempotent in $\omega(\mathcal{R})$ is non-constant. By holomorphicity, it is enough to show non-constancy along $\mathcal{E}^{\mathbb{R}}$. The beau a priori bounds imply that $P(\mathcal{E}^{\mathbb{R}})$ is a compact set, and since P is a sufficiently regular idempotent, it must be a manifold. As expected from a deformation space, $\mathcal{E}^{\mathbb{R}}$ turns out to be contractible, so its image by an idempotent is contractible as well. Since the only contractible compact manifold is a point, we

conclude that $P|\mathcal{E}^{\mathbb{R}}$ must be indeed constant. This implies, by contradiction, that the renormalization groupoid is uniformly contracting, as desired.

Remark 6.1. The argument above uses only a few properties of the renormalization groupoid (holomorphicity, real-symmetry, and appropriate precompactness along $\mathcal{E}^{\mathbb{R}}$), and can be used to establish uniform contraction of any other groupoid with those properties. In particular, finer geometric properties of infinitely renormalizable maps (that tend to be quite dependent on the combinatorics and degree) can play no role. In previous, more restricted, approaches, contraction was always ultimately obtained as a consequence of such less robust features.

References

- [Ar] Arnold, V. I. Small denominators. I. Mapping the circle onto itself. *Izv. Akad. Nauk SSSR Ser. Mat.* 25 1961 21–86.
- [A1] Avila, A. Global theory of one frequency operators I: stratified analyticity of the Lyapunov exponent and the boundary of nonuniform hyperbolicity. Preprint.
- [A2] Avila, A. Global theory of one frequency operators II: acriticality and finiteness of phase transitions for typical potentials. Preprint.
- [A3] Avila, A. In preparation.
- [A4] Avila, A. Chaoticity of the Teichmüller flow. To appear in “Homogeneous flows, Moduli Spaces and Arithmetic”, Clay Mathematics Proceedings.
- [AKLS] Avila, A.; Kahn, J.; Lyubich, M.; Shen, W. Combinatorial rigidity for unicritical polynomials. *Ann. of Math. (2)* 170 (2009), no. 2, 783–797.
- [AK1] Avila, A.; Krikorian, R. Reducibility or non-uniform hyperbolicity for quasiperiodic Schrödinger cocycles. *Ann. of Math.* 164 (2006), 911–940.
- [AK2] Avila, A.; Krikorian, R. In preparation.
- [AL1] Avila, A., Lyubich, M. The full renormalization horseshoe for unimodal maps of higher degree: exponential contraction along hybrid classes. Preprint.
- [AL2] Avila, A., Lyubich, M. In preparation.
- [ALS] Avila, A.; Lyubich, M.; Shen, W. Parapuzzle of the multibrot set and typical dynamics of unimodal maps. To appear in *Journal of the European Mathematical Society*.
- [AS] Avron, Joseph; Simon, Barry Almost periodic Schrödinger operators. II. The integrated density of states. *Duke Math. J.* 50 (1983), no. 1, 369–391.
- [BJ] Bourgain, J.; Jitomirskaya, S. Continuity of the Lyapunov exponent for quasiperiodic operators with analytic potential. *J. Statist. Phys.* 108 (2002), no. 5–6, 1203–1218.
- [BKNS] Bruin, H.; Keller, G.; Nowicki, T.; van Strien, S. Wild Cantor attractors exist. *Ann. of Math. (2)* 143 (1996), no. 1, 97–130.

- [DKN] Deroin, B.; Kleptsyn, V.; Navas, A. Sur la dynamique unidimensionnelle en régularité intermédiaire. *Acta Math.* 199 (2007), no. 2, 199–262.
- [DS] Dinaburg, E. I.; Sinai, Ja. G. The one-dimensional Schrödinger equation with quasiperiodic potential. *Funkcional. Anal. i Priložen.* 9 (1975), no. 4, 8–21.
- [DH] Douady, Adrien; Hubbard, John Hamal On the dynamics of polynomial-like mappings. *Ann. Sci. Ecole Norm. Sup. (4)* 18 (1985), no. 2, 287–343.
- [FM1] de Faria, Edson; de Melo, Welington Rigidity of critical circle mappings. I. *J. Eur. Math. Soc. (JEMS)* 1 (1999), no. 4, 339–392.
- [FM2] de Faria, Edson; de Melo, Welington Rigidity of critical circle mappings. II. *J. Amer. Math. Soc.* 13 (2000), no. 2, 343–370.
- [F] Feigenbaum, M. Quantitative universality for a class of nonlinear transformations. *J. Statist. Phys.* 19 (1978), 25–52.
- [GoSc] Goldstein, M.; Schlag, W. Hölder continuity of the integrated density of states for quasi-periodic Schrödinger equations and averages of shifts of subharmonic functions. *Ann. of Math. (2)* 154 (2001), no. 1, 155–203.
- [GJLS] Gordon, A. Y.; Jitomirskaya, S.; Last, Y.; Simon, B. Duality and singular continuous spectrum in the almost Mathieu equation. *Acta Math.* 178 (1997), no. 2, 169–183.
- [GS] Graczyk, J.; Świątek, G. Generic hyperbolicity in the logistic family. *Ann. of Math. (2)* 146 (1997), no. 1, 1–52.
- [HS] Helffer, B.; Sjöstrand J. Semiclassical analysis for Harper’s equation. III. Cantor structure of the spectrum. *Mém. Soc. Math. France* 39 (1989), 1–124.
- [H1] Herman, M. Sur la conjugaison différentiable des difféomorphismes du cercle à des rotations. *Inst. Hautes Études Sci. Publ. Math.* No. 49 (1979), 5–233.
- [H2] Herman, M. Une méthode pour minorer les exposants de Lyapounov et quelques exemples montrant le caractère local d’un théorème d’Arnold et de Moser sur le tore de dimension 2. *Comment. Math. Helv.* 58 (1983), no. 3, 453–502.
- [J] Jakobson, M. Absolutely continuous invariant measures for one-parameter families of one-dimensional maps, *Commun. Math. Phys.* 81 (1981), 39–88.
- [KT] Khanin, K.; Teplinsky, A. Robust rigidity for circle diffeomorphisms with singularities. *Invent. Math.* 169 (2007), no. 1, 193–218.
- [KSS] Kozlovski, O.; Shen, W.; van Strien, S. Rigidity for real polynomials. *Ann. of Math. (2)* 165 (2007), no. 3, 749–841.
- [Kol] Kolmogorov, A.N. The general theory of dynamical systems and classical mechanics. *Proceedings of the International Congress of Mathematicians (Amsterdam, 1954)*, Vol. 1, pages 315–333, North Holland, Amsterdam, 1957.
- [La] Lanford III, O. A computer-assisted proof of the Feigenbaum conjectures, *Bull. Amer. Math. Soc.* 6 (1982), 427–434.
- [LS] Levin, G.; van Strien, S. Local connectivity of Julia sets of real polynomials, *Annals of Math.*, 147 (1998), 471–541.

-
- [L1] Lyubich, Mikhail Combinatorics, geometry and attractors of quasi-quadratic maps. *Ann. of Math. (2)* 140 (1994), no. 2, 347–404.
- [L2] Lyubich, Mikhail Dynamics of quadratic polynomials. I, II. *Acta Math.* 178 (1997), no. 2, 185–247, 247–297.
- [L3] Lyubich, Mikhail Dynamics of quadratic polynomials. III. Parapuzzle and SBR measures. *Astérisque* No. 261 (2000), 173–200.
- [L4] Lyubich, Mikhail Feigenbaum-Coullet-Tresser universality and Milnor’s hairiness conjecture. *Ann. of Math. (2)* 149 (1999), no. 2, 319–420.
- [L5] Lyubich, Mikhail Almost every real quadratic map is either regular or stochastic. *Ann. of Math. (2)* 156 (2002), no. 1, 1–78.
- [LY] Lyubich, M.; Yampolsky, M. Dynamics of quadratic polynomials: Complex bounds for real maps. *Ann. Inst. Fourier.*, 47 (1997), 1219–1255.
- [McK] MacKay, R. Renormalization in area-preserving maps. World Sci. Publ. Co., 1993.
- [Man] Mané, R. Ergodic theory and differentiable dynamics. Springer Verlag, Berlin, 1987.
- [MN] Martens, M.; Nowicki, T. Invariant measures for typical quadratic maps. *Astérisque* No. 261 (2000), 239–252.
- [M] Masur, Howard Interval exchange transformations and measured foliations. *Ann. of Math. (2)* 115 (1982), no. 1, 169–200.
- [MS] de Melo, Welington; van Strien, Sebastian One-dimensional dynamics. Springer-Verlag, Berlin, 1993.
- [McM] McMullen, C. Renormalization and 3-manifolds which fiber over the circle. *Annals of Mathematics Studies*, 142. Princeton University Press, Princeton, NJ, 1996.
- [SK] Sinai, Ya. G.; Khanin, K. M. Smoothness of conjugacies of diffeomorphisms of the circle with rotations. *Uspekhi Mat. Nauk* 44 265 (1989), 57–82, 247.
- [S1] Sullivan, D. Quasiconformal homeomorphisms in dynamics, topology and geometry. *Proc. ICM-86, Berkeley II, A.M.S., Providence, RI* (1987), 1216–1228.
- [S2] Sullivan, D. Bounds, quadratic differentials, and renormalization conjectures. *AMS Centennial Publications II, Mathematics into Twenty-first Century*, 417–466, 1992.
- [S3] Sullivan, D. Reminiscences of Michel Herman’s first great theorem. *Gaz. Math.* No. 88 (2001). Société Mathématique de France, Paris, 2001. pp. 91–94.
- [TC] Tresser, C.; Coullet, P. Itérations d’endomorphismes et groupe de renormalisation. *C. R. Acad. Sci. Paris* 287A (1978), 577–580.
- [V1] Veech, William A. Gauss measures for transformations on the space of interval exchange maps. *Ann. of Math. (2)* 115 (1982), no. 1, 201–242.
- [V2] Veech, William A. The Teichmüller geodesic flow. *Ann. of Math. (2)* 124 (1986), no. 3, 441–530.

-
- [Ya1] Yampolsky, Michael The attractor of renormalization and rigidity of towers of critical circle maps. *Comm. Math. Phys.* 218 (2001), no. 3, 537–568.
- [Ya2] Yampolsky, Michael Hyperbolicity of renormalization of critical circle maps. *Publ. Math. Inst. Hautes Études Sci. No. 96* (2002), 1–41.
- [Y1] Yoccoz, J.C. Il n'y a pas de contre-exemple de Denjoy analytique. *C. R. Acad. Sci. Paris Sér. I Math.* 298 (1984), no. 7, 141–144.
- [Y2] Yoccoz, J.-C. Conjugaison différentiable des difféomorphismes du cercle dont le nombre de rotation vérifie une condition diophantienne. *Ann. Sci. École Norm. Sup. (4)* 17 (1984), no. 3, 333–359.

Highly Composite

R. Balasubramanian*

Abstract

Partly owing to the legend of Ramanujan, generations of Indian mathematicians after him have been fascinated with analytic number theory. We provide an account of the varied Indian contribution to this subject from Ramanujan to relatively recent times.

Mathematics Subject Classification (2010). Primary 11Mxx; Secondary 01A32.

Keywords. Ramanujan, Indian mathematics, analytic number theory

1. Introduction

The story of Srinivasa Ramanujan (1887–1920) is perhaps the most striking episode in modern Indian mathematics. The beauty of his results, the mark of originality in his methods, his short life and its tragic end never fail to make an impression. It is only natural that the influence of such a remarkable life should extend well beyond its time and indeed this was the case. For instance, the distinguished astrophysicist S. Chandrasekhar tells us that the facts of Ramanujan’s life were “more than enough for aspiring young Indian students to break their bonds of intellectual confinement and perhaps soar the way that Ramanujan did” ([13], page 4).

Our purpose in the present article is to trace the broad influence of Ramanujan on Indian mathematics roughly from the year of his death (1920) to relatively recent times, that is, the decade of the 1980s. In doing this we hope to highlight for the present and preserve for the future, an account of mathematics in India, however limited in scope, in the decades surrounding India’s independence in 1947. We believe this was a period during which much was done but about which very little has been written. Moreover, the highly composite contribution to mathematics from this period was largely made without the aid of support structures commonly available to professional mathematicians today.

*Institute of Mathematical Sciences, C.I.T. Campus, Tharamani, Chennai 600 113.
E-mail: balu@imsc.res.in

In undertaking our task we have set ourselves certain limits. We end our coverage with the 1980s because much of the mathematics done in India from the mid 1980s and thereafter is by mathematicians who are still active. Also, we restrict our trace of Ramanujan's influence to mathematicians who worked in analytic number theory, for the reason that our own research interests lie in this subject. With these explicitly imposed limits, and many others implicit and somewhat arbitrary, the present article is certainly not a thorough study. It is meant, and we believe it is necessary, to provoke a genuinely scholarly enquiry into its subject.

We begin our account with Professor K. Ananda Rau, India's first analyst of repute.

2. An Inspiring Teacher

If Ramanujan's influence in India is the tree whose branches we describe in the following pages then K. Ananda Rau is its root. Indeed, as our narrative unfolds, the reader will not fail to notice that students of Ananda Rau and their mathematical descendants are the protagonists of much of what we have to say.

Krishnaswami Ananda Rau was born in 1893 into a well-connected family in Chennai (then Madras), where he grew up. He attended first the Hindu High School and then the Presidency College of the University of Madras, both among the best institutions in India at that time. Throughout his studies he evidently took care to maintain an excellent academic record, for we find him doing very well at every important examination that came his way ([57], page 1). In 1914, and incidentally only a few months after Ramanujan, Ananda Rau sailed for England where he entered King's College, Cambridge. In the two years that followed, Ananda Rau prepared for and took the Cambridge Mathematical Tripos examinations, finishing in 1916 with a first class honours in both parts of this exam ([11], page 260). Ananda Rau was subsequently elected a fellow of King's College and soon after came under the influence of G.H. Hardy, whose encouragement and guidance initiated Ananda Rau into mathematical research.

By 1918 Ananda Rau had published his first paper, a note in the Proceedings of the London Mathematical Society [59], and won the Smith prize for an essay written the previous year, partially advised by Hardy. Ananda Rau arrived at the subject of the note [59] through a paper of Hardy's [36] on (λ, k) summability. Let us recall this notion. When $\lambda_1, \lambda_2, \dots, \lambda_n, \dots$ is an increasing sequence of real numbers ≥ 0 with $\lambda_n \rightarrow +\infty$ as $n \rightarrow +\infty$ and k a positive real number, a sequence $c_1, c_2, \dots, c_n, \dots$ is said to be (λ, k) summable to C if we have

$$\lim_{x \rightarrow +\infty} \frac{1}{x^k} \sum_{\lambda_n \leq x} (x - \lambda_n)^k c_n = C. \quad (1)$$

In [36], Hardy shows that if the sequence $c_1, c_2, \dots, c_n, \dots$ is (λ, k) summable and c_n satisfies the side condition $c_n = O\left(\frac{\lambda_n - \lambda_{n-1}}{\lambda_n}\right)$ then in fact $\sum c_n$ is convergent. In his note [59], Ananda Rau begins by informing the reader that Hardy's argument is not complete. He remarks that while Hardy's argument does show, given the side condition, that (λ, k) summability implies $(\lambda, 1)$ summability when k is an integer, to which case we may confine the entire discussion, it does not prove that $(\lambda, 1)$ summability implies $\sum c_n$ is convergent. Ananda Rau then states that he intends to fill this gap by supplying this last step and swiftly modifies Hardy's argument to achieve his goal. The note [59] is short and its contents relatively straightforward from today's perspective. But then, Ananda Rau was writing in 1918 and he was less than 24 when he communicated his note. What plainly stands out in [59], however, is the clarity of the author's exposition and his attention to detail – qualities that Ananda Rau came to be admired for later as a teacher.

In his Smith prize essay, Ananda Rau took up a different theme, also related to summability. He obtains in this essay a number of results for generalised Dirichlet series that generalise what was known, due to Hardy and Littlewood, on the abscissae of summability of ordinary Dirichlet series. We learn from the footnote on page 4 of [57] that he decided to publish results from his essay on learning accidentally that Marcel Riesz, to whom he had earlier communicated the entire essay, had referred to one of his results. A part of his essay in slightly modified form [60] finally appeared in 1932 in the Proceedings of the London Mathematical Society.

Ananda Rau, it appears, first met Ramanujan in England though it is entirely possible that he may have at least known of Ramanujan earlier. Indeed, R. Ramachandra Rao, to whom Ramanujan presented some of his work in 1910 and who remained, in Hardy's words, a "most devoted friend" of Ramanujan ([41], page xxi), was a relative of Ananda Rau's ([11], page 260). At any rate, Ananda Rau and Ramanujan became good friends while at Cambridge and Ananda Rau has written that Ramanujan "was quite sociable, very polite and considerate to others. He was a man full of humour and a good conversationalist, and it was always interesting to listen to him" ([13], page 2). Ananda Rau returned to India from Cambridge in 1919 and was appointed Professor of Mathematics at his former college, the Presidency College, at the age of 26.

Among the first few papers that Ananda Rau authored upon returning to Chennai is the article [61] that has the Riemann zeta function for its subject. A fundamental property of the Riemann zeta function is the canonical factorization of the entire function $(s-1)\zeta(s)$ given by the relation

$$(s-1)\zeta(s) = e^{P(s)} \prod_{n \geq 1} \left(1 + \frac{s}{2n}\right) e^{-\frac{s}{2n}} \prod_{\rho} \left(1 - \frac{s}{\rho}\right) e^{\frac{s}{\rho}}, \quad (2)$$

where $P(s)$ is the linear polynomial $A + Bs$ with $A = \zeta(0)$, $B = -\frac{\zeta'(0)}{\zeta(0)}$ and ρ varies over the zeros of $\zeta(s)$ that are not real. The relation (2) is usually

obtained by applying Hadamard's theorem on the canonical factorisation of entire functions of finite order on noting that $(s-1)\zeta(s)$ is an entire function of order 1. Indeed, an easy application of Jensen's formula taking into account the order of growth of $(s-1)\zeta(s)$ shows that $\sum \frac{1}{|\rho|^2}$ converges. Consequently, the product on the right hand side of (2) converges and defines an entire function with the same zeros, counted with multiplicity, as $(s-1)\zeta(s)$. The principal difficulty in the proof of (2) lies in showing that $P(s)$ is a linear polynomial. Within arguments leading to Hadamard's theorem this is often done by first obtaining an appropriate lower bound for the canonical factors on the right hand side of (2) in the complement of the union of small discs centered at the zeros of these factors. In [61], Ananda Rau gives an elegant proof of (2) that does not depend on any direct consideration of the canonical factors but relies on additional properties of $\zeta(s)$. The principle of his method is to use an integral representation for the difference of the logarithmic derivatives of the two sides of (2). More precisely, he notes that when $s \neq 1$, the Cauchy residue theorem applied to the boundary ∂C of a rectangular region C containing 0 and 1 and such that no zero of $\zeta(s)$ lies on ∂C gives

$$\frac{1}{2\pi i} \int_{\partial C} \frac{\zeta'(z)}{\zeta(z)} \frac{dz}{z(z-s)} = \frac{1}{s} \frac{\zeta'(s)}{\zeta(s)} + \frac{1}{s-1} - \frac{1}{s} \frac{\zeta'(0)}{\zeta(0)} + \sum_{x \in C} \frac{1}{x(x-s)}, \quad (3)$$

where x varies over zeros of $\zeta(s)$ lying in C . By means of the Borel-Caratheodory theorem applied to $\zeta(s)$, Ananda Rau constructs a sequence of rectangular regions C_m with sides all going to infinity with m and such that integral on the left hand side of (3) taken along ∂C_m in place of ∂C tends to 0 as m tends to infinity. On applying (3) to C_m , passing to the limit and rearranging the terms of the resulting relation, Ananda Rau then completes his derivation of (2). It has been shown by K. Chandrasekharan ([14], pages 43-45) that Ananda Rau's idea of starting from an integral representation of the form (3) may in fact be adapted to give a simple proof of Hadamard's theorem in its full generality. In the literature one also finds variants of such an argument, for example it is possible to start from the Jensen-Poisson formula in place (3) ([49], page 26). Chandrasekharan remarks that his method can be extended to obtain R. Nevanlinna's factorisation theorem for meromorphic functions as well ([14], page 56).

Perhaps on account of his early work on summability and the importance that Hardy attached to this topic, Ananda Rau remained attracted to this theme for a number of years. His work, and that of his many distinguished students, in summability and the closely related Tauberian theory, gained his school a formidable international reputation. In the later part of his career, Ananda Rau turned to questions on Elliptic functions and then to the representation of integers as sums of squares and finally to Waring's problem, publishing in all 24 papers, the last of which appeared posthumously.

By all accounts, Ananda Rau was an excellent teacher. We have it from V. Ganapathy Iyer that "as a student I used to feel that his exposition of any topic

was so clear and impressive that I need not study the topic again" ([57], page 2). C.T. Rajagopal, the author of [57] and a doctoral student of Ananda Rau tells us that Ananda Rau's "way with research workers was to encourage them and expect them to formulate their own problems and then to discuss the problems with them". All of T. Vijayaraghavan, S.S. Pillai, K. Chandrasekharan and S. Meenakshisundaram, who later became famous for his work on the spectral theory of the Laplacian, were mentored by Ananda Rau.

Ananda Rau retired from the Presidency College in 1948 at the age of 55, then the normal retirement age, after 29 years of distinguished service for which he was awarded, already in 1937, the title of "Rao Bahadur" - equivalent to an O.B.E. - by the Government of India of that time. Retirement did not however ebb his enthusiasm for mathematics, and he continued working on his interests almost to the end of his life. Ananda Rau died in 1966, aged 73.

3. Pillai, Sathe and Integers with k Prime Factors

We now turn to a problem that arose from the work of Hardy and Ramanujan on the "rarity of round numbers" and that led to the introduction by Selberg of an important method in analytic number theory for estimation of partial sums of Dirichlet series with singularities that are not poles. Our focus shall, of course, be on the key contributions to this problem from S.S. Pillai, a student of Ananda Rau, and L.G. Sathe, who was a student of S.S. Pillai. Our account here is based on a recently discovered unpublished manuscript [54] of S.S. Pillai titled "Report on Sathe's Solution of a Problem of Hardy's" that will now appear in the collected works of Pillai [10].

Let us set up our backdrop by reviewing a result from the famous paper of Hardy and Ramanujan [38] on the normal number of prime factors of natural numbers. We are told by G.H. Hardy ([41], page 48) that both Ramanujan and himself observed the phenomenon that round numbers, that is, natural numbers with a considerable number of comparatively small prime factors, are very rare. This is somewhat paradoxical since one may expect in fact the opposite to be true. In [38] Hardy and Ramanujan provide mathematical explanations for this phenomenon by showing, among other results, that almost all natural numbers n have $\log \log n$ distinct prime divisors. More precisely, they show that if $\omega(n)$ is the number of distinct prime divisors of n and $f(x)$ is any function that increases to $+\infty$ as x increases to $+\infty$ then we have that

$$\text{Card} \left\{ n \mid 1 \leq n \leq x \text{ and } |\omega(n) - \log \log n| \geq f(n) \sqrt{\log \log n} \right\} = o(x). \quad (4)$$

The above relation marks the genesis of what is now called Probabilistic Number Theory - the application of probability theory to problems in analytic number theory. In effect, it suggests that the numbers $\omega(n)$ are well-distributed and

therefore that $(\omega(n) - \log \log n) / \sqrt{\log \log n}$ should have a distribution function, a hope that was eventually realised, following the works of Turán and Kubilius, in a famous theorem of Erdős and Kac which shows the required distribution function to be the Gaussian.

Hardy and Ramanujan motivate the results of their paper [38] by means of the following heuristic. For any positive real number x , let us write $\pi_k(x)$, for $k \geq 1$, to denote the number of integers $n \leq x$ such that n has k distinct prime factors. Thus, for example, $\pi_1(x)$ is nothing but $\pi(x)$, the counting function of the primes. With this notation we have the relation

$$[x] = 1 + \sum_{k \geq 1} \pi_k(x). \quad (5)$$

On the other hand, we have the obvious relation

$$x = \frac{x}{\log x} e^{\log \log x} = \sum_{k \geq 1} \frac{x(\log \log x)^{k-1}}{(k-1)! \log x}. \quad (6)$$

Since $[x]$ is rather close to x , one may look upon the above relations as suggesting a term wise comparison of the terms in the sums over k in (5) and (6). This heuristic is supported by the fact that a well-known theorem of E. Landau, that is relatively easily proved starting from $\pi_1(x) \sim \frac{x}{\log x}$ (the prime number theorem) and an induction on k , tells us that for any given $k \geq 1$ we have

$$\pi_k(x) \sim \frac{x(\log \log x)^{k-1}}{(k-1)! \log x} \quad (7)$$

as $x \rightarrow +\infty$. The main step in the proof of (4) given by Hardy and Ramanujan is to show that the contribution from the tail of the sum over k in (5) is small and for this they replace the asymptotic relation (7) with an inequality of the shape

$$\pi_k(x) \leq \frac{Ax(C + \log \log x)^{k-1}}{(k-1)! \log x} \quad (8)$$

where A and C are both independent of k and x .

It is easily seen by comparing successive terms of the sum over k in (6) that the largest terms in this sum correspond to k around $\log \log x$. Moreover, the major contribution to this sum comes from the terms around the largest terms. It is then natural to ask, taking account of the aforementioned heuristic, if Landau's asymptotic relation (7), which is stated for a fixed integer k , remains valid with $k = [\log \log x]$. Hardy posed this as a problem to his class while he was at Oxford, which he was from 1919 to 1931. T. Vijayaraghavan, whom we will meet in the following section, was at Oxford from 1925 to 1928 working with Hardy and learnt of this problem. He then transmitted this problem to S.S. Pillai, according to [54].

Dr. Subbayya Pillai Sivasankaranarayana Pillai, to give S.S. Pillai his full name, was, together with his friend and collaborator Sarvadaman Chowla, one

of the two greatest Indian number theorists to emerge in the era immediately after Ramanujan; a mathematician whose contributions may well have been much greater were his life not repeatedly visited by misfortune. S.S. Pillai was born on 5 April, 1901 in Vallam, a small town in present day Tamilnadu, where his father was a contractor for the government. Pillai, however, lost both his parents before he completed his High School, his mother passing away within a year of his birth. Nevertheless, with the aid of a scholarship and financial assistance from a teacher at high school who recognised the talent in young Pillai, he persevered. He first went to the Scott Christian College at Nagercoil in Tamilnadu and then to Maharaja's College at Thiruvananthapuram in Kerala, where he obtained his B.A.

On being awarded a stipendiary research studentship from the University of Madras, he moved to Chennai around 1927. It was at the University of Madras that Pillai's talents blossomed under the inspiring guidance of T. Vaidyanathaswamy and Ananda Rau, influenced, by the reason of his mathematical interests, more by the latter than the former. Through his time at this university, Pillai wrote a number of papers, three of which constituted his thesis for a Master's degree, and met a number of his contemporaries including Vijayaraghavan, from whom, as we have already said, he learnt of Hardy's problem of obtaining the asymptotic of Landau for $k = \lfloor \log \log x \rfloor$.

In 1929, Pillai was appointed a lecturer at Annamalai University, Chidambaram in Tamilnadu. In the same year Pillai [53] announced an important breakthrough on Hardy's problem. He was able to show that the inequality

$$\pi_k(x) > \frac{Hx(\log \log x)^{k-1}}{(k-1)! \log x} \quad (9)$$

holds for any $k < e \log \log x$ and a constant H . Moreover, that Landau's asymptotic relation holds for all k with $k = o(\log \log x)$. These results enabled him to easily deduce that $\pi_k(x) > Cx/(\log \log x)^{1/2}$, for $k = \lfloor \log \log x \rfloor$ and a positive C , a result also conjectured by Hardy and obtained, independently, by Paul Erdős ([37], page 56). For reasons that are not clear, Pillai did not publish a detailed proof of these results.

Pillai remained at Annamalai University for 12 years following his appointment. In the course of these years Pillai was awarded the degree of D.Sc. by the University of Madras, the first to be awarded by this University in Mathematics ([15], page 2), and carried out some of his best work, including much of his remarkable researches on Waring's problem that we summarize in Section 6. Pillai himself tells us in [54] that he also continued to work at Hardy's problem off and on. In 1941, Pillai moved to Travancore from Chidambaram and left in the following year to take up a position at Calcutta University.

In Calcutta (now Kolkata) Pillai met the brilliant L.G. Sathe, who became his student. In 1943, Pillai suggested Hardy's problem to Sathe and put at Sathe's disposal all of his manuscripts on this problem. In the course of less than two years, L.G. Sathe produced a monumentally complex induction argument,

that ran into 134 printed pages when published, and that did much more than solve Hardy's problem. In particular, and for the first time, Sathe was able to show that Landau's asymptotic remained valid for $k < \epsilon \log \log x$. When finally published in 1954, Sathe's result would supercede a theorem of Erdős [33], which appeared in 1948 and which solves Hardy's problem by obtaining Landau's asymptotic for k in an interval of length about $\sqrt{\log \log x}$ around $\log \log x$.

The sequence of events leading to publication of Sathe's work, however, remain somewhat unclear. It is clear, though, that Sathe submitted his work to the Transactions of American Math. Society (see [15], page 2) and, from the footnote on the first page of [72], that Selberg's comments on this work were sought by the editors of the Transactions. Finally, however, Sathe's work appeared in the Journal of Indian Mathematical Society, of which K. Chandrasekharan was the editor at that time, in four parts, the first part in 1953 and the last in 1954 [71]. Selberg's observations on this work, originally prepared for the Transactions of the American Math. Society, were written up in the form of a note titled "Note on a paper of L.G. Sathe" that follows the last part of Sathe's paper in the Journal of the Indian Math. Society.

Selberg begins his note [72] by telling us that while the results of Sathe's paper are "very beautiful and highly interesting" the proof is a "rather complicated and involved one, and this by necessity since a proof by induction starting from the case $k = 1$ presents overwhelming difficulties in keeping track of the estimates of the remainder terms..". Selberg then goes on to give a simple analytic proof of a stronger version of Sathe's result by considering the complex powers of $\zeta(s)$. For a modern expert's account of Selberg's method we refer to [73], Chapters II. 5 and II.6.

Pillai's good fortune in having Sathe's association did not, unfortunately, last long. Shortly after his work on Hardy's problem, Sathe was struck by a cruel illness that incapacitated him ([15], page 2). The final twist in Pillai's life occurred on August 31, 1950 when the plane carrying him to the United States crashed near Cairo, killing all on board. Pillai was on his way to the I.C.M. of 1950 at Harvard and was to spend the following year at the Institute for Advanced Studies at Princeton. Dr. S.S. Pillai was 49 years old when he died.

4. Chowla-Pillai Correspondence and Vijayaraghavan

Sarvadaman Chowla was, as his biographical sketch [45] puts it, one of the best-known number theorists from India to have followed in the tradition of Ramanujan. Sarvadaman Chowla was an extraordinarily productive mathematician and authored around 350 papers through a span of 60 years. It is difficult, as the authors of [50] suggest, to survey in one sweep the full breadth

of his vast contributions. On account of Chowla's collected papers [44] being available, prefaced by a number of first hand accounts of his life and an elegant summary of his work [50], we shall be brief in our coverage here, meaning only to supplement [45] and [50].

Born in London in 1907, Chowla was brought up in Lahore from where he eventually went for his doctoral studies to Cambridge in 1929 and completed his dissertation in 1931 under the supervision of J.E. Littlewood. On his return to India, he was appointed a lecturer at St. Stephen's College, Delhi and subsequently taught at the Benares Hindu University and the Andhra University, Waltair before returning to a professorship once held by his father at the Government College in Lahore in 1936. He remained in this position till 1948, when he emigrated to the United States. Following a stay at the Institute for Advanced Studies, Princeton, he took up appointments at Kansas, Boulder and finally Pennsylvania State University in 1963. Professor Chowla died in 1995, aged 88.

Starting in the late 1920s, and up to one month before his death, S.S. Pillai and Sarvadaman Chowla maintained a regular correspondence for about 20 years. Through the years they corresponded, Chowla and Pillai published five joint papers and met numerous times at the conventions of the Indian Mathematical Society, of which both were very active members. Their correspondence is very revealing for the insight it gives us, as one may expect, into the mathematics and the friendship of Chowla and Pillai. The earliest letter from Chowla available in the papers left behind by Pillai is dated 8 January, 1929. This letter discusses, among a number of questions, the number 175,95,9000, the smallest integer that is expressible as a sum of two positive cubes in three different ways. The letter ends with Chowla expressing the hope that they will soon "begin proper work". This in fact did happen and by the middle of 1929 they were well on their way to their first joint paper (paper number 25 in [44]), which appeared in 1930. In this paper, Chowla and Pillai obtain for $E(x)$ defined by the relation

$$\sum_{1 \leq n \leq x} \phi(n) = \frac{3}{\pi^2} x^2 + E(x), \quad (10)$$

where $\phi(n)$ is the Euler function, an asymptotic for its mean and an Ω -result. An Ω -result is an expression of the form $f(x) = \Omega(g(x))$, where $g(x) > 0$ for sufficiently large x , and means that there is an $A > 0$ such that $|f(x)| > Ag(x)$ for an unbounded sequence of real numbers x . Chowla and Pillai showed that $\sum_{1 \leq n \leq x} E(n) \sim \frac{3}{2\pi^2} x^2$ and that $E(x) = \Omega(x \log \log \log x)$. In his letter to Pillai postmarked 29 April 1929 Chowla discusses a preliminary form of their mean value result and says that he thinks very likely that $E(x)$ changes sign infinitely often. This suggestion is interesting because Sylvester, who made tables of the left hand side and the first term on the right hand side of (10) upto 1000, had in fact conjectured just the opposite, that $E(x)$ is always positive. It turned out, however, that Sylvester missed noticing that $E(820) < 0$, a fact observed

in 1936, seven years after Chowla's letter, by M.L.N. Sarma [52]. Chowla's conjecture was proved to be correct in 1951 by Erdős and Shapiro [33]. For the details on this matter, including a copy of Chowla's letter, we refer to [1]. Chowla and Pillai followed up their study of $E(x)$ with a study (paper number 26 in [44]) of analogous questions in the case when $\phi(n)$ is replaced by $\sigma(n)$, the sum of the divisors of n .

The second theme that Pillai and Chowla worked together on was a problem that has its roots in Indian mathematics from the first millennium. Given a natural number N , it is of interest in the solution of the so-called Pell equation $x^2 - Ny^2 = 1$ to determine the length L of period of the continued fraction representation for \sqrt{N} . It is relatively easy to show that this length is $\leq 2N$. T. Vijayaraghavan [78] showed in 1927 that in fact this length is $\leq C\sqrt{N} \log N$, for an explicitly determined constant $C > 0$, whose value Chowla subsequently improved in 1929 (paper 20 in [44]). In 1931 Chowla and Pillai (paper 36 in [44]) improved this bound to $L = O(\sqrt{N} \log \log N)$ under the Riemann hypothesis for the Dirichlet L-functions. Thereafter, their joint works related to topics around Waring's problem, a theme that was of great interest to both Pillai and Chowla, and to which we will turn in Section 6. The last letter from Chowla to Pillai is dated June, 1950 and in it Chowla tells Pillai that he may not be in Princeton when Pillai arrives – which, as we saw at the end of the last section, did not happen.

Tirukkannapuram Vijayaraghavan, whom we have had occasion to mention in the preceding paragraph and in Section 2, was born in 1902 in what is now Tamilnadu. He schooled at a number of places and did well. He then went to Pachaiyappa's College in Madras (now Chennai) for his honours degree but this time did not do well enough to obtain his degree. Fortunately, however, his talent came to the attention of K. Ananda Rau, who arranged to have him admitted into the Presidency College. Vijayaraghavan published his first mathematical works even before he completed his college studies. In an early note in 1924 [79] he showed that rational numbers of the form $\phi(n)/n$, where $\phi(n)$ is the Euler function, are dense in $[0, 1]$. Around 1921, Vijayaraghavan began sending his work to G.H. Hardy, much in the fashion of Ramanujan, whose story was by now well-known. Hardy, it appears, did not respond immediately this time but when he did, he urged the University of Madras to provide Vijayaraghavan a scholarship so that Vijayaraghavan could visit him. This was done and Vijayaraghavan worked with Hardy through the years 1925 to 1928.

Vijayaraghavan was a problem solver in the best sense of the phrase. Not one to be confined to a particular branch of mathematics, he worked on any problem that interested him. While the most important parts of his work fall in the area of summability and Diophantine approximations – the Pisot -Vijayaraghavan numbers bear his name – he returned to questions in analytic number theory from time to time, on account of his close friendship with Pillai and Chowla. Chowla and Vijayaraghavan collaborated on three papers, the last of which appeared the year Chowla left for the United States. Professor Vijayaraghavan

died in 1955, at the age of 53. For more extensive biographies of Vijayaraghavan we refer to [16], which is our source, and to [28].

Chowla's lasting contribution to Indian mathematics has been through the number of young persons of his time that he encouraged and taught. R.P. Bambah, F.C. Auluck, Abdul Majid Mian and the great physicist Abdus Salam, were all taught by Chowla. Professor Bambah vividly describes his time with Chowla on page xxxi of [44], that led among a number of other results, to their famous argument showing that for any $\epsilon > 0$ there is a sum of two squares in the interval $[x, x + 2\sqrt{2 + \epsilon x^{\frac{1}{4}}}]$ for all sufficiently large x (paper 167 in [44]). After his time with Chowla in Lahore, Bambah himself went to Cambridge, where he worked with Mordell, and thereafter set up the famous school in the Panjab University, Chandigarh, on Geometry of Numbers. The reader will find a summary, authored by Professor Hans-Gill, of some of the key results of this school in the notes to Chapter 24 of [42].

5. TIFR and Ramachandra

With the departure of Chowla to the United States in 1948 and the death of Pillai in 1950, we leave the first epoch of development of analytic number theory in India and enter the second. The influence of Ramanujan continued to abide even as the emphasis shifted to themes related to the more analytic and modular parts of his work. If a single event can be said to mark the beginning of this epoch, it is the emergence of the school of mathematics at the Tata Institute of Fundamental Research (TIFR), Mumbai under the guidance of K. Chandrasekharan.

Komaravolu Chandrasekharan was born in 1920 at Machillipatnam in Andhra Pradesh. After his schooling in Bapatla, Andhra Pradesh he left for Madras (now Chennai) to study at the Presidency College from where he obtained his M.A. and came under the influence of K. Ananda Rau. In 1942 Chandrasekharan obtained his Ph.D. from the University of Madras for a thesis written under the supervision of Ananda Rau. For a few years after his Ph.D., Chandrasekharan taught at the Presidency College. Around 1947, Chandrasekharan left for a term at the Institute for Advanced Studies in Princeton.

Chandrasekharan's early work, following the trend in Ananda Rau's school, was in the area of Summability theory, a topic to which his research remained connected throughout the 1940s. Indeed, by 1950 he had authored an important monograph with S. Meenakshisundaram on Riesz's Typical Means [17]. In Princeton, and working jointly with Salomon Bochner, he also took up a number of issues in Fourier Transform theory, on which he published in 1948 a now well-known book with Bochner. Nevertheless, throughout this period we see in his papers an undercurrent of analytic number theory that eventually surfaced in his later work with Bochner and in the long series of papers with Raghavan Narasimhan. In 1949 Chandrasekharan moved to the TIFR on the invitation of its founder Homi J. Bhabha, who met him that year on a visit to Princeton.

The crucial role that Chandrasekharan has played in transforming TIFR into a centre of excellence in mathematical research has been described by Professor M.S. Raghunathan in ([62], page 536), to which we refer the reader. It would be, however, very remiss for us not to mention here the important contribution Chandrasekharan has made through his well-known expository books on analytic number theory, the first books by an Indian author on this topic. These books have served a number of mathematicians after him, such as the author, as elegant introductions to their subjects. Professor Chandrasekharan retired from the TIFR in 1965 and moved to Zürich, Switzerland, where he now resides.

In his efforts at building the school of mathematics at TIFR, Chandrasekharan was ably aided by K.G. Ramanathan, who joined this school in 1951. Kollagunta Gopalaiyer Ramanathan was born in Andhra Pradesh (at Hyderabad) in 1920, only eight days before Chandrasekharan and he too eventually went to the University of Madras from which he obtained his M.A. and worked for some time as a research scholar. Like Chandrasekharan, he then visited the Institute for Advanced Studies, Princeton. At Princeton, he was an assistant to Hermann Weyl and became an admirer of Siegel's mathematics. Siegel, who at that time, was visiting the IAS made a deep impression on Chandrasekharan and Ramanathan and, through them, and his own visits to the TIFR, greatly influenced the problems in number theory that the TIFR school took up. Ramanathan was an "illustrious and colourful personality" ([70], page 4) and energetically guided the study of number theory at the TIFR. For a fuller biography of Professor K.G. Ramanathan, who died in 1992, we refer to [70].

With Chandrasekharan and Ramanathan for its helmsmen, the fledgling TIFR school did not take long to make a mark in number theory. By 1965, very significant results in number theory were obtained in at least three directions – the works of K. Chandrasekharan and Raghavan Narasimhan on O and Ω -results for Riesz means, mean values of error terms for the summatory functions of a wide class of arithmetical functions [18],[19], [21] and on approximate functional equations [20], the work of C.P. Ramanujan on cubic forms [66] and his solution of Siegel's conjecture on Waring's problem for number fields [67], and K. Ramachandra's thesis [63] on applications of the Kronecker limit formula.

Raghavan Narasimhan, who is now famous for his contributions to function theory, joined TIFR as a student in 1957. Chandrasekharan's works with Raghavan Narasimhan were the first major works done in the theory of zeta functions in India after Chowla. The above cited papers are a selection from a long series of papers in which Chandrasekharan and Narasimhan undertook to obtain for a wide class of Dirichlet series satisfying a functional equation resembling that of the Riemann zeta function, a number of key properties that were at that time known essentially only for the Riemann zeta function. By means of their results they were easily able to deduce, for example, that if $p = (p_1, p_2, \dots, p_n)$ is any point in \mathbf{R}^n , for some integer $n \geq 1$, and if for any $x > 0$, $N(x, p)$ denotes the number of lattice points in the ball of radius x

centered at p and $V(x, p)$ is its volume then

$$N(x, p) - V(x, p) = \Omega_{\pm}(x^{\frac{n-1}{2}}). \quad (11)$$

This result, given in [22] as an illustration of the results in [19] and [18], vastly generalises what was originally known only for the case of circle in the plane, by Hardy.

The bare sketch of the life of C.P. Ramanujam reads, sadly, like that of his namesake Srinivasa Ramanujan – a highly original mind and a tragic death at a young age. His works mentioned above are his earliest, after which, he turned to Algebraic Geometry. The problems considered in [66] and [67] were suggested to Ramanujam by K.G. Ramanathan. Since we cannot hope to substitute for the moving account of Ramanujam's life and the elegant summary of his papers [66] and [67] written by K.G. Ramanathan in ([65], pages 1 to 7), we refer the reader to this source.

Kanakanahalli Ramachandra was born in 1933 and after his studies at the Central College, Bangalore where he obtained his B.Sc.(Hons) and M.Sc. degree, Ramachandra joined the TIFR as a student in 1958. In the following year, he attended the famous course given by Siegel [76] at the TIFR centered on the Kronecker limit formula, and, at the suggestion of K.G. Ramanathan, subsequently took up the questions addressed in [63]. In this paper Ramachandra makes a remarkable application of Kronecker's second limit formula to the theory of complex multiplication, to the construction of a certain maximally independent set of units in a given class field of an imaginary quadratic field and to the evaluation of a certain elliptic integral, originally given by Chowla and Selberg and also by Ramanujan. The units constructed by Ramachandra in [63] have come to be known as Siegel-Ramachandra-Robert units or, sometimes, elliptic units.

Starting about the end of the 1960s, Ramachandra's interests turned to the theory of the Riemann zeta function and to Baker's method in transcendental number theory. The intense passion with which he pursued these subjects have made him synonymous with their development in India. His work attracted a number of students and associates some of whom are Professor T.N. Shorey, who is renowned for his contributions to the applications of Baker's theory, and the distinguished mathematicians the brothers Professors Ram and Kumar Murty, whose own role in the progress of number theory in India is visible in the curriculum vitae of almost every number theorist in India today, and Professor Kannan Soundararajan.

We now present a small and personal selection of simple yet powerful ideas from Ramachandra's garden. We begin with an exposition of a simple method for obtaining lower bounds for the mean square on a vertical line segment of a function $f(s)$ which is the analytic continuation of an absolutely convergent Dirichlet series. This method, sometimes called the multiple averaging method, which first appeared in the thesis of the author, written under the supervision of Ramachandra [3] and the resulting lower bound have been put to a number

of uses by Ramachandra and his collaborators. Throughout the remainder of this section, s will denote a complex number with real part σ and imaginary part t , following established notation in analytic number theory. We will also use \ll and \gg to mean Vinogradov's well-known notation.

Suppose that $f(s)$ is a holomorphic function in a neighbourhood of the half plane $\sigma > 0$ and is given by absolutely convergent Dirichlet series

$$\sum_{n \geq 1} \frac{a(n)}{n^s} \tag{12}$$

when $\sigma > 2$. Let $H \geq 1$ be a real number and M be a positive integer with $M \leq H^{1-\epsilon}$ for an $\epsilon > 0$ and sufficiently small. Let us set $A(s)$ to be the Dirichlet polynomial given by the sum of the first M terms of the series (12) and write $B(s)$ to denote $f(s) - A(s)$. Our aim is to show, under conditions that are often met in practice, that

$$\int_T^{T+H} |f(it)|^2 dt \gg H \sum_{1 \leq n \leq M} |a(n)|^2, \tag{13}$$

which gives an essentially optimal lower bound for the mean square of $f(s)$ on a segment of the imaginary axis. To do this we start from the obvious relation

$$|f(it)|^2 = |A(it)|^2 + |B(it)|^2 + 2\text{Re}(\overline{A(it)}B(it)). \tag{14}$$

Let I be any interval satisfying the condition

$$[T, T + H] \supseteq I \supseteq \left[T + \frac{H}{4}, T + \frac{3H}{4} \right]. \tag{15}$$

On integrating both sides of (14) over the interval I we deduce by positivity that

$$\int_T^{T+H} |f(it)|^2 dt \geq \int_{T+\frac{H}{4}}^{T+\frac{3H}{4}} |A(it)|^2 dt + 2 \int_I \text{Re}(\overline{A(it)}B(it)) dt. \tag{16}$$

The principle now is to exploit the flexibility in (16) with respect to the interval I by averaging this relation over a family of intervals I satisfying (15). In effect, let r be a positive integer and U a positive real number such that $rU \leq \frac{H}{4}$. Then, for any real numbers u_1, u_2, \dots, u_r lying in the interval $[0, U]$, the interval

$$I = \left[T + u_1 + u_2 \dots + u_r, T + \frac{3H}{4} + u_1 + u_2 \dots + u_r \right] \tag{17}$$

satisfies (15). We apply (16) to the above I and integrate over all the u_i , with each u_i varying in $[0, U]$. On dividing the resulting relation by U^r and using $\text{Re}(z) \geq -|z|$ for any complex number z we deduce that

$$\int_T^{T+H} |f(it)|^2 dt \geq \int_{T+\frac{H}{4}}^{T+\frac{3H}{4}} |A(it)|^2 dt - 2|P|, \tag{18}$$

where P denotes the integral

$$\frac{1}{U^r} \int_0^U \int_0^U \cdots \int_0^U \int_{T+u_1+u_2+\dots+u_r}^{T+\frac{3H}{4}+u_1+u_2+\dots+u_r} \overline{A(it)}B(it) dt du_1 du_2 \dots du_r . \quad (19)$$

By a well-known theorem of Montgomery and Vaughan, the first integral on the right hand side of (18) is $\gg H \sum_{1 \leq n \leq M} |a(n)|^2$ since $H \geq M$. To obtain our lower bound (13) it therefore suffices to show that $|P|$ is small compared to the right hand side of (13). To this end let us set

$$F(s) = \sum_{1 \leq n \leq M} \overline{a(n)}n^s . \quad (20)$$

Then $F(s)$ is an entire function whose restriction to the the imaginary axis is $\overline{A(it)}$. Moreover, the growth properties of $B(s)$, which are the same as that of $f(s)$, are such that error in replacing the integral (19) with the integral

$$\frac{1}{U^r} \int_0^U \int_0^U \cdots \int_0^U \int_{T+u_1+u_2+\dots+u_r}^{T+\frac{3H}{4}+u_1+u_2+\dots+u_r} F(3+it)B(3+it) dt du_1 du_2 \dots du_r \quad (21)$$

by Cauchy's integral formula is small compared to the right hand side of (13). We now note that $B(3+it)$ is given by an absolutely convergent Dirichlet series. Using this expression for $B(s)$ together with (20) and integrating term-by-term we conclude that the integral (21) is the same as

$$\sum_{\substack{n \leq M \\ m > M}} \overline{a(n)}a(m)P(n, m) \left(\frac{n}{m}\right)^3 \quad (22)$$

where $P(n, m)$ is the integral

$$\frac{1}{U^r} \int_0^U \int_0^U \cdots \int_0^U \int_{T+u_1+u_2+\dots+u_r}^{T+\frac{3H}{4}+u_1+u_2+\dots+u_r} \left(\frac{n}{m}\right)^{it} dt du_1 du_2 \dots du_r . \quad (23)$$

On making the change of variable $t \mapsto t + u_1 + u_2 \dots + u_r$ in the integral with respect to t in (23) we easily see that

$$P(n, m) = \left(\int_T^{T+\frac{3H}{4}} \left(\frac{n}{m}\right)^{it} dt \right) \left(\frac{1}{U} \int_0^U \left(\frac{n}{m}\right)^{-iu} du \right)^r . \quad (24)$$

Let us recall that $\int_x^y a^{it} dt = (a^{iy} - a^{ix})/\log a$ for positive real a . Using this to evaluate the integrals in (24) and then applying the triangle inequality we deduce that

$$|P(n, m)| \leq \frac{2^{r+1}}{U^r |\log(\frac{n}{m})|^{r+1}} \leq \frac{(2M)^{r+1}}{U^r} , \quad (25)$$

where the last inequality follows on noting that $n \leq M$ and $m \geq M + 1$ and therefore that $|\log(\frac{n}{m})| \geq \frac{1}{M}$. On now taking $U = H^{1-\frac{\epsilon}{2}}$, r to be the largest integer with $4r \leq H^{\frac{\epsilon}{2}}$ and recalling that $M \leq H^{1-\epsilon}$, we see that $P(n, m) \ll H^{-k}$ for any $k > 0$ and sufficiently large H depending only on k and ϵ . This bound is sufficient to offset any contribution from the remaining terms of the sum (22), making $|P|$ as small as required.

A key advantage of the lower bound (13) is that H does not depend on T . This allows us, in applications, to take H as small as a power of $\log T$. Ramachandra and his collaborators have applied this observation to obtain a number of Ω -results. Thus, for example, by applying the lower bound (13) to $\zeta(\frac{1}{2} + s)^k$ for any positive integer k , we evidently get lower bounds for mean value of $|\zeta(s)|^{2k}$ on an interval of the form $[T, T + H]$ on the line $\sigma = \frac{1}{2}$. These lower bounds are uniform in k . By letting k tend to $+\infty$, it has then been shown in [8] that

$$\sup_{T \leq t \leq T+H} |\zeta(\frac{1}{2} + it)| \geq \exp\left(\frac{1}{2} \frac{(\log H)^{\frac{1}{2}}}{(\log \log H)^{\frac{1}{2}}}\right) \quad (26)$$

for H as small as a power of $\log T$. Thus we infer that $\zeta(\frac{1}{2} + it)$ takes large values rather frequently. Let us remark here that in [8] the above relation is given with an indeterminate constant D in place of $\frac{1}{2}$; the constant was given the value $\frac{3}{4}$ in [5] in place of $\frac{1}{2}$ above. It has, however, been kindly pointed out to the author by Professor Soundararajan that the method of [5] does not yield a constant larger than 0.57. Soundararajan has recently made a remarkable improvement to the above result by showing that we may take the constant to be as large as 3.5.

One may also apply the lower bound (13) to obtain Ω -results for error terms in the asymptotic expansion of the summatory functions of various arithmetical functions. To see how this is done, let us assume that $f(s)$ is a meromorphic function in $\sigma > 0$ but is given by the Dirichlet series (12) when $\sigma > 1$. Then define $E(x)$ by the relation

$$\sum_{n \leq x} a(n) = M(x) + E(x) \quad (27)$$

where $M(x)$ is the main term, that is, the contribution to the asymptotic expansion (27) from a given set of poles S of f in $\sigma \geq 0$. By a classical argument, we have $E(T) = \Omega(T^a)$ for an a in $(0, 1)$ if

$$\int_T^{2T} |f(a + it)|^2 dt \gg T^2, \quad (28)$$

and f is holomorphic in a neighbourhood of $\sigma \geq a$ except for the poles S . This is shown by an application of Parseval formula for the Mellin transform together with a contour integration over a rectangular contour that has one vertical side on $\sigma = a$ and the other vertical side at a σ where f is given by the Dirichlet

series (13). Roughly speaking, we would like to extend the method so as to cover the case when f has infinitely many poles in the half-plane $\sigma \geq a$, with a such that (28) holds and a condition controlling the growth of the number of poles of f up to an ordinate T . Such a result will allow us to obtain an Ω -result when $a(n)$ is the characteristic function of the square-full numbers, that is, n such that $p|n \implies p^2|n$. In this case $f(s) = \zeta(2s)\zeta(3s)/\zeta(6s)$.

If a rectangular contour is used in the setting we have described, then this contour must necessarily lie to right of all the poles of f not contained in S ; but this will not allow us to use (28) since the contour no more extends to the line $\sigma = a$. It therefore becomes necessary to use a contour that is the union of a number of vertical and horizontal line segments designed so as to avoid the poles of f in an appropriate manner. The vertical line segments making up such a contour could be of length a power of $\log T$. Then, in order to calculate a lower bound for the mean square of f on such segments, we necessarily require (13). Indeed, it is by such an argument that Ramachandra, M.V. Subbarao and the author [9] were able to improve the Ω -result in the square full numbers problem from $T^{\frac{1}{12}}$, given by the classical method of Landau, to $T^{\frac{1}{10}}$. For an exposition of this method together with a number of other applications we refer to [48].

We now turn to what Ramachandra has called the Hooley-Huxley contour – the name was meant as Ramachandra's expression of thanks to M.N. Huxley for explaining to him a closely related idea of C. Hooley's. The purpose of this contour is to evaluate, for x a sufficiently large real number, h satisfying $1 \leq h \leq x$, $c = 1 + \frac{D}{\log x}$, for some $D > 0$, $T = x^\theta$ for some θ with $0 < \theta < 1$, the integral

$$\int_{c-iT}^{c+iT} f(s) \frac{(x+h)^s - x^s}{s} ds, \quad (29)$$

where $f(s)$ is given in $\sigma > 1$ by the absolutely convergent Dirichlet series (12) with $a(n) \ll n^\epsilon$ and the implicit constant depending only on ϵ . The interest in this integral is due to the fact that it appears in the following relation, which is a particular case of the well-known Perron's formula.

$$\sum_{x \leq n \leq x+h} a(n) = \frac{1}{2\pi i} \int_{c-iT}^{c+iT} f(s) \frac{(x+h)^s - x^s}{s} ds + O\left(\frac{x^{1+\epsilon}}{T}\right), \quad (30)$$

where the constant implicit in the O symbol depends only on ϵ . The sum on the left hand side of (30) is called a short interval sum of $a(n)$ and is of interest in numerous problems in number theory. The goal is to obtain an asymptotic formula for the left hand side for all large enough x and h suitably small compared to x . We assume that there are positive real numbers a_1, a_2, a_3 and a_4 , with a_1 satisfying the crucial requirement that $a_1 < 1$, such that the inequalities

$$\sigma > 1 - \frac{a_2}{(\log |t|)^{a_1}} \text{ when } |t| \geq a_3, \quad (31)$$

$$\sigma > 1 - a_4 \text{ when } |t| < a_3. \quad (32)$$

define an open neighbourhood U of $\sigma \geq 1$ to which f extends as a meromorphic function with a unique pole and that at $s = 1$. This assumption simplifies what one sees in a number of applications, where f has an algebraic singularity at $s = 1$ rather than a pole. The method below may, however, be adapted to serve in such situations as well. For sufficiently large x , our assumptions on U allow us to treat the integral (29) by moving the line of integration in (29) to the line $\sigma = \beta_0$, where

$$\beta_0 = 1 - \frac{a_2}{2(\log T)^{a_1}}. \tag{33}$$

When this is done, we pick up the main term of the asymptotic expansion for the left hand side of (30) at the pole $s = 1$ and replace c in the integral (29) with β_0 , with an error that is negligible with respect to this main term, which is of order h .

In order to show that the integral (29) with $c = \beta_0$, is also small compared to h , we would ordinarily move the line of integration further into the half plane $\sigma < 1$. In a number of interesting cases, however, this is obstructed by the presence of algebraic singularities of f in the strip $0 < \sigma < 1$. The main observation of Ramachandra [64], following Hooley and Huxley, is that this set of singularities is sparsely distributed close to the line $\sigma = 1$ and that this may be taken advantage of by deforming the line of integration in (29) into a contour – the Hooley-Huxley contour – that stays away from these singularities but over which the integral may readily be shown to be of smaller order than h . Let us now provide a more precise description of this contour.

Let Z be a discrete closed subset of the strip $0 < \sigma < 1$ and let Ω be the complement in $\sigma > 0$ of the union of the line segments $0 < \sigma \leq \text{Re}(z)$, with z varying over Z . Let us suppose that U is contained in Ω and that f extends meromorphically to Ω with a unique pole and this at $s = 1$. Further, we assume that there exists a real number $A \geq 1$ such that for any $\sigma \geq 1 - \frac{1}{A}$ we have

$$\text{Card}\{z \in Z \mid \sigma \leq \text{Re}(z), |\text{Im}(z)| \leq |T|\} \ll T^{A(1-\sigma)} \text{ for all } T \geq 1. \tag{34}$$

Finally, let us set $B = 1 - \frac{1}{A}$, $T = x^{1-B-\epsilon}$ and write L to denote $\frac{1}{\log T}$.

Let $t_0 < t_1 < \dots < t_m$ be an increasing sequence of real numbers lying in the interval $[-T, T]$, with $t_0 = -T$ and $t_m = T$, and

$$(\log T)^p \leq t_i - t_{i-1} \leq 2(\log T)^p \tag{35}$$

for each i and some fixed integer $p \geq 1$. Define \mathcal{K}_i for $1 \leq i \leq m$ as the set of complex numbers $s = \sigma + it$ with σ in $[B + L, \beta_0]$ and t in $[t_{i-1}, t_i]$ that satisfy the additional condition

$$\sigma \geq \text{Re}(z) + L \text{ for each } z \in S \text{ with } t_{i-1} - L \leq \text{Im}(z) \leq t_i + L. \tag{36}$$

It is easily verified that each \mathcal{K}_i is a rectangle lying in U , and that, by (31) and (32), the left side of each of the rectangles \mathcal{K}_i lies in the strip $B + L \leq \sigma \leq \beta_0 - 2L$ for sufficiently large x , while the right side of \mathcal{K}_i is the line segment

$[\beta_0 + it_i, \beta_0 + it_{i-1}]$. The complement of the open line segment $(\beta_0 - iT, \beta_0 + iT)$ in the oriented boundary of the union of the rectangles K_i is the Hooley-Huxley contour \mathcal{H} . By (36) each point on \mathcal{H} is at a distance at least L from Z . This allows us to show, for f we meet in applications, that $|f(s)| \ll (\log T)^k$ for all s on \mathcal{H} and some integer $k \geq 1$. By the mean value theorem, we have $|(x+h)^s - x^s|/s \leq x^{\sigma-1}$, for all s with $\sigma > 0$. Consequently, the integrand in (29) is $\ll hx^{\sigma-1}(\log T)^k$, for all s on \mathcal{H} .

Let the abscissae of the vertical line segments of \mathcal{H} be $\beta_1, \beta_2, \dots, \beta_n$, numbered along the orientation of \mathcal{H} , for some integer $n \geq 1$, and set $\beta_{n+1} = \beta_0$. Also, for any j , let l_j denote the length of the vertical segment with abscissa β_j . With this notation let us show that the integral over \mathcal{H} of the integrand in (29) is majorised, up to a constant, by

$$h(\log T)^{p+k} \left(x^{\beta_0-1} + \sum_{B+L < \beta_j < \beta_0} N(\beta_j - L)x^{\beta_j-1} + x^{B+L-1} \sum_{\beta_j=B+L} l_j \right). \tag{37}$$

For any j , the contribution to the integral from the vertical segment with abscissa β_j is $\ll h(\log T)^k l_j x^{\beta_j-1}$. For any $\beta \geq B$ let us write $N(\beta)$ for the number of z in Z with $\text{Re}(z) = \beta$ and $|\text{Im}(z)| \leq 2T$. Then if $B + L < \beta_j$, it is easily seen that the number of K_i whose left sides make up the vertical segment with abscissa β_j does not exceed $2N(\beta_j - L)$. Consequently, for such β_j we have $l_j \ll N(\beta_j - L)(\log T)^p$. Summing over j , for $1 \leq j \leq n$, we see that the contribution from the vertical segments of \mathcal{H} is majorised, up to a constant, by (37). The length of any horizontal segment of \mathcal{H} is ≤ 1 . Therefore, for any j with $1 \leq j \leq n + 1$, the contribution to the integral from the horizontal segment of \mathcal{H} with end points at abscissae β_{j-1} and β_j is $\ll h(\log T)^k (x^{\beta_{j-1}-1} + x^{\beta_j-1})$. Summing over j , and noting that $N(\beta_j - 1) \geq 1$ for $1 \leq j \leq n$, we conclude that the contribution from the horizontal segments of \mathcal{H} is also majorised, up to a constant, by (37).

It remains to check that (37) is $o(h)$ for a sufficiently large x . The first term in the parenthesis is of the form $\exp(-C(\log x)^{1-a_1})$, for some $C > 0$ taking account of our choice of T . Since $x^L \ll 1$, second sum in (37) does not exceed $\sum_{B < \beta < \beta_0} N(\beta)x^{\beta-1}$, which is finite since $N(\beta) \neq 0$ for only finitely many β . On partitioning the interval $[B, 0]$ into sub-intervals, each of length between L and $2L$, we obtain using (34) that this last sum is majorised by

$$\frac{1}{L} \max_{B \leq \sigma \leq \beta_0} \sum_{\sigma < \beta < \sigma + 2L} N(\beta)x^{\beta-1} \ll \max_{B \leq \sigma \leq \beta_0} x^{\sigma+2L-1} T^{A(1-\sigma)} \log T. \tag{38}$$

Since $T = x^{\frac{1}{A}-\epsilon}$, we conclude from (38) that the second sum in (37) is $\ll x^{A\epsilon(\beta_0-1)}$, which is of the form $\exp(-C(\log x)^{1-a_1})$, for some $C > 0$. The last sum in the parenthesis is $\leq 2T$. Since $x^L \ll 1$, it follows that the last term in the parenthesis is $\ll x^{B-1}T \ll x^{-\epsilon}$. Collecting these estimate together and

recalling that $a_1 < 1$, we conclude that (37) is indeed $o(h)$. Since we have chosen $T = x^{\frac{1}{A}-\epsilon}$, we require that $h \geq x^{B+3\epsilon}$ so that h dominate the error term in (30). Thus for this choice of h the preceding method yields an asymptotic formula for the short interval sum under the various hypotheses that have been made. For a number of applications of the Hooley-Huxley contour we refer the reader to the papers of M.D. Coleman ([24], [25], [26]) and P.Zarzycki [83],

Our final section considers a problem that has seen substantial Indian contribution over the last century.

6. Waring's Problem

A famous theorem of Lagrange, originally conjectured by Fermat, states that every natural number is the sum of 4 squares of natural numbers. By way of extending this theorem, the English mathematician Edward Waring wrote down in 1770 an assertion that now bears his name and that has since been interpreted as saying that for every integer $k \geq 1$ we have that

$$\sup_{n \geq 0} \inf \{s \mid s \geq 1, n = x_1^k + \dots + x_s^k \text{ for some } x_1, \dots, x_s \in \mathbf{N}\} \quad (39)$$

is finite and that this supremum is 9 when $k = 3$, is 19 when $k = 4$ and so on. Here and below, \mathbf{N} denotes the set of natural numbers $\{0, 1, 2, \dots\}$.

Modern notation for the supremum defined in (39) is $g(k)$, while that for the closely related

$$\limsup_{n \rightarrow +\infty} \inf \{s \mid s \geq 1, n = x_1^k + \dots + x_s^k \text{ for some } x_1, \dots, x_s \in \mathbf{N}\} \quad (40)$$

is $G(k)$. In less formal terms $g(k)$, for any integer $k \geq 1$, is nothing but the smallest number of k -th powers of natural numbers required to represent every natural number as a sum of k -th powers of natural numbers. Similarly, $G(k)$ is the smallest number of k -th powers of natural numbers required to represent every sufficiently large natural number as a sum of k -th powers of natural numbers. With this notation, Waring's assertion is that $g(k)$ is finite for all $k \geq 1$ and that $g(3) = 9$, $g(4) = 19$ and so on.

The problem of supplying a proof of Waring's assertion, and more generally, of determining the values of $g(k)$ and $G(k)$ for all $k \geq 1$, has occupied a number of mathematicians over the last three centuries, during which period this question came to be known as Waring's problem. A thorough account of the history of Waring's problem being plainly out of the scope of this article, we present here a sketch detailed enough for us to discuss the salient Indian contribution to this problem.

The earliest recorded work on Waring's problem dates to 1772 and is due J.A. Euler, a son of Leonard Euler, who obtained, for all $k \geq 1$, the lower bound

$$g(k) \geq \left\lceil \frac{3^k}{2^k} \right\rceil + 2^k - 2. \quad (41)$$

The inequality (41) is easily justified. In effect, for a given $k \geq 1$ let $n < 3^k$ be a natural number and a, b be natural numbers such that $n = a2^k + b$, with $b \leq 2^k - 1$. Then the smallest number s such that n is a sum of s k -th powers is $a + b$. Further, the maximum value of $a + b$ when a, b are natural numbers such that $a2^k + b < 3^k$ is attained when $a = \left\lfloor \frac{3^k}{2^k} \right\rfloor - 1$ and $b = 2^k - 1$. Consequently, we deduce that the integer $c(k)$ defined by

$$c(k) = \left(\left\lfloor \frac{3^k}{2^k} \right\rfloor - 1 \right) 2^k + 2^k - 1 = 2^k \left\lfloor \frac{3^k}{2^k} \right\rfloor - 1 \quad (42)$$

requires, among the natural numbers $n < 3^k$, the largest number of k -th powers in order to be represented as their sum. Since, moreover, the number of k -th powers so required is the right hand side of (41), this inequality is verified.

Intuitively speaking, the smaller the number of k -th powers not exceeding a natural number n , the larger the number of k -th powers that may be required to represent n as the sum of k -th powers of natural numbers. It is therefore reasonable to expect that the value of $g(k)$ is determined by an initial segment of the k -th powers of natural numbers. This expectation is fortified by the observation that the right hand side of (41), which, as we noted above, is smallest number of k -th powers required to represent $c(k)$, coincides with the values of $g(k)$ for $k = 1, 2, 3, 4$ given by Lagrange's theorem and Waring. All of this leads us to the conjecture that (41) is an equality for all $k \geq 1$.

Plainly, the first step in proving the preceding conjecture is to show that $g(k)$ is indeed finite for any integer $k \geq 1$ and this is already not trivial. The original proof of this fact, due to Hilbert [43] in 1909, is an induction on k and is based on the existence of polynomial identities of the shape

$$(x_1^2 + x_2^2 + \dots + x_n^2)^k = \sum_{1 \leq i \leq N} a_i (c_{1i}x_1 + \dots + c_{ni}x_n)^{2k} \quad (43)$$

for any integers $n, k \geq 1$ and a suitable positive integer N , positive rational numbers a_i and integers c_{ij} dependent on n and k . Let us remark here that the first determination of $g(k)$, for k different from 1 and 2, was $g(3) = 9$ by Weferich in 1909, together with Kempner in 1912, was also by exploiting polynomial identities. Hilbert's argument has since been revisited and simplified by a number of authors, our preference being for the account of W. Ellison on pages 23 to 29 of [35].

Hilbert's method in [43] is ineffective in the sense that it shows the finiteness of $g(k)$ without providing any upper bound for $g(k)$ in terms of k . Even when this method is rendered effective, as is now known to be possible from Rieger [68], the upper bounds for $g(k)$ so obtained are generally stratospherically high owing to the inductive structure of the method. For this reason the problem of obtaining upper bounds for $g(k)$ of the same strength as the right hand side (41) required a different current of ideas, which came with the work of Hardy and Ramanujan [39] on the partition function.

In their paper [39], Hardy and Ramanujan inaugurated a new analytic method for obtaining the asymptotic behaviour of an arithmetical function, that is, a complex valued function on \mathbf{N} . More precisely, suppose that c is an arithmetical function and that the associated generating series $f(z) = \sum_{n \in \mathbf{N}} c(n)z^n$ has the unit disc for its domain of holomorphy. The Cauchy integral formula then gives the relation

$$c(n) = \frac{1}{2\pi i} \int_{|z|=r} \frac{f(z)}{z^{n+1}} dz, \quad (44)$$

for any $r < 1$ and $n \in \mathbf{N}$. In this setting Hardy and Ramanujan had the extremely fertile insight that for a number of arithmetical functions the dominant contribution to the integral on the right hand side of (44), when r is sufficiently close to 1, comes from the neighbourhood of points $z = e^{2\pi i \frac{p}{q}}$ where $\frac{p}{q}$ is a rational number with “small” denominator q . With the aid of this observation, applied to case when $c(n)$ is the arithmetical function $p(n)$, the number of ways of writing n as a sum of natural numbers, Hardy and Ramanujan [39] obtained a famously sharp asymptotic formula for $p(n)$. In the final section of this paper they discuss briefly the applicability of their method to the problem of studying the number of representations of a natural number by the sum of a given number of squares of integers.

In a pioneering series of papers titled “Some problems of Partitio Numerorum”, Hardy and Littlewood developed the insight of Hardy and Ramanujan into a powerful tool for the treatment of additive problems often called the Hardy-Littlewood circle method, the circle in this name being in reference to the integral on the boundary of a disc on the right hand side of (44). In particular, Hardy and Littlewood applied their method to Waring’s problem by considering this integral with

$$f(z) = \left(1 + \sum_{n \geq 1} 2z^{n^k} \right)^s, \quad (45)$$

and obtained, in the fourth paper [40] of their series published in 1922, the bound $G(k) \leq (k-2)2^{k-1} + 5$, for any $k \geq 1$.

The work of Hardy and Littlewood made it clear that the problem of improving upon their upper bound for $G(k)$ was central to further progress on Waring’s problem. This goal remained elusive up to the end of the 1920s, when I.M. Vinogradov entered the scene. Vinogradov’s first paper on the subject [81], published in 1928, introduced major technical simplifications into the method of Hardy and Littlewood that allowed him to recover their bound with “incomparable brevity and simplicity” ([80], page 101). In effect, Vinogradov replaces the infinite series $f(z)$ of (45) with the finite trigonometric sum

$$f(t) = \sum_{1 \leq x \leq P} e^{2\pi i x^k t}, \quad (46)$$

where x and P denote integers, and the integral on the right hand side of (44) with

$$\int_0^1 f(t)^s e^{-2\pi int} dt \quad (47)$$

On expanding the $f(t)^s$ and using the orthogonality of the exponentials $e^{2\pi int}$ as functions on $[0, 1]$, it is immediate that the integral (47) evaluates to the number of representations $r_s(n)$ of n as a sum of k -th powers of positive integers when $n \leq P^k$. Vinogradov then applies the Hardy-Littlewood-Ramanujan method to deduce the asymptotic behaviour of this integral for suitably large n and P , from which he recovers the Hardy-Littlewood bound for $G(k)$. In the years following [81], Vinogradov introduced a number of important innovations into the treatment of trigonometric sums with the aid of which he obtained in 1935 the remarkable inequality

$$G(k) \leq 6k \log k + k \log 216 . \quad (48)$$

Vinogradov's method, as also the original Hardy-Littlewood method, is completely effective. In other words, it is possible to compute from this method a natural number $N_0(k)$ such that every $n \geq N_0(k)$ is represented as $x_1^k + \dots + x_s^k$ with $s \ll k \log k$ and natural numbers x_i .

Vinogradov's method for the bound (48) rendered viable, for the first time, the following simple two step strategy for showing that (41) is an equality for all $k \geq 1$. We set s to be the right hand side of (41) for a given k .

- (i) Compute using Vinogradov's method a natural number $N_1(k)$ such that the number of k -th powers required to represent any $n \geq N_1(k)$ does not exceed s .
- (ii) Directly verify that every natural number $n < N_1(k)$ is the sum of s k -th powers.

The first step works out because the right hand side of (48) is much smaller than the right hand side of (39) for large k . The step (ii) is then executed by means of a clever argument called the method of ascent, developed largely by L.E. Dickson. This method works in two stages. First, one observes by a direct computation that for a given k and natural numbers n in a range beyond $c(k)$, the number of k -th powers required to represent n decreases sharply from the number required for $c(k)$, that is, s . One then exploits this reduction in the number of k -th powers required to represent these n to show that the number of k -th powers required to represent all larger n up to $N_1(k)$ does not exceed s .

With the field so set by Vinogradov's method, the years 1935 to 1940 saw an intense amount of work on the determination of $g(k)$. A leading role in this effort was played by S.S. Pillai, and essentially independently, by L.E. Dickson. We present below a summary of S.S. Pillai's work on $g(k)$ based in part on a talk given by him at a symposium in 1939 [55] and an unpublished manuscript of

his, which will now appear in [10], pages 656-659. For a description of Dickson's results we refer to his paper [32] and the references in it.

Let k be a natural number ≥ 1 and let a and b be respectively the quotient and remainder obtained on dividing 3^k by 2^k . Thus $3^k = a2^k + b$ and a, b are natural numbers with $b \leq 2^k - 1$. By December, 1935 Pillai showed that if

$$b < 2^k - 1 - a - 1 \quad (49)$$

then (41) is an equality for all sufficiently large k . He published this result in the Journal of the Annamalai University, Vol. V(2) that appeared in March, 1936. In January, 1936, he improved this result and showed that (41) is an equality for all k with $8 \leq k \leq 100$ and also for any $k > 100$ satisfying the condition (49). This result was published in the Journal of the Indian Mathematical Society, Vol. II which appeared in May-June, 1936. He then took up the situation complementary to the condition (49) considering, more precisely, the case when

$$b \geq 2^k - 1 - a + 2. \quad (50)$$

When (50) holds it is no more true that $g(k)$ is given by the right hand side of (41) and Pillai's paper in the Journal of Annamalai University, VI(1) that appeared in October-November, 1936 gives the correct expression for $g(k)$ in this case. Since this expression for $g(k)$ is slightly complicated, we do not reproduce it here, but refer the reader to page 50 of Pillai's paper or page 447 of [42]. In a second paper in the same issue of the Journal of Annamalai University, Pillai completed his determination of $g(7)$ by showing that $g(7) = 143$. Then in 1940, following the work of Van Der Corput on Weyl's inequality, Pillai obtained $g(6) = 73$ in his paper [56]. This result of Pillai was probably the most important mathematical achievement in India of his time.

Pillai's interest in Waring's problem was not limited to the determination of $g(k)$. In his collected works [10] the reader will find his contributions to Waring's problem with prime power summands, to the problem of representing a number as a sum of k non-negative k -th powers and to the polynomial case, together with all his papers cited in our summary above.

When neither of the conditions (49) and (50) hold, we must either have equality in (49) or that $b = 2^k - a - 1$ or $b = 2^k - a$. In the first of these cases, it was shown by I. Niven [51] in 1944 that we in fact have equality in (41). On the other hand, Dickson showed in 1936 that $b \neq 2^k - a - 1$ for any k , leaving us with the possibility that $b = 2^k - a$. This was also shown to be impossible for $k > 1$ by R.K. Rubugunday in 1942 [69].

Raghunath Krishna Rubugunday was born in Chennai (then Madras) in 1918 and after a brilliant performance at school and Presidency college, where he did his B.A. Hons., he left following family tradition - K. Ananda Rau was an uncle on his father's side - for Cambridge. At Cambridge, Rubugunday was classed as Wrangler of Cambridge Tripos Part II in 1938 ([58], page 192) and subsequently came under the influence of Hardy. On his return to India, Rubugunday taught at various universities, his last position being the Head of

the Department of Mathematics at Saugar University (now Dr. Hari Singh Gaur University), Madhya Pradesh. Professor Rubugunday passed away in Chennai in the year 2000.

In summary, we have seen that by 1944 all values of $g(k)$ were determined except for $g(4)$ and $g(5)$ but that this determination was subject to one of the conditions (49) and (50). It has been conjectured that the condition (50) which can be written in the form

$$2^k \left\{ \left(\frac{3}{2} \right)^k \right\} + \left[\left(\frac{3}{2} \right)^k \right] > 2^k \quad (51)$$

does not hold for any $k \geq 4$. The problem of proving this conjecture is sometimes called the ideal Waring's problem because its truth, from what we have said above, will imply that (41) is an equality for all $k \geq 1$. It is known from the work of Mahler that the number of k for which (50) holds is in fact finite, though an effective bound for such a k is unknown at present. For more details on this matter we refer the reader to page 302 of [77].

As the reader will no doubt have noticed by now, an essential feature of Waring's problem of determining $g(k)$ is that the smaller the value of k the harder it has been to determine $g(k)$. This is rooted in the fact that for smaller values of k , $G(k)$ and $g(k)$ do not differ by much. For example, when $k = 4$, the right hand side of (41) evaluates to 19. On the other hand, by a celebrated result of Davenport [27] from 1939 we have $G(4) \leq 16$. When taken together with a remark of Kempner [47] that, for any $n \geq 0$, the number 31.16^n requires at least 16 fourth powers for its representation as their sum, Davenport's result gives $G(4) = 16$.

When $g(k)$ and $G(k)$ are close, the natural number $N_1(k)$ of step (i) above worked out from Vinogradov's method in its original form turns out far too large to be accessible to the ascent argument of step (ii). Thus the determination of $g(5)$ had to wait almost 25 years after the phase of activity we have described. This was done in 1965 by the noted Chinese mathematician Jing-Run Chen who showed in [23] that $g(5) = 37$.

We shall now discuss in some detail the determination of $g(4)$ by Deshouillers, Dress and author in 1986, who showed that $g(4) = 19$, which is to say that every natural number is a sum of no more than 19 biquadrates, that is fourth powers of natural numbers, as originally asserted by Waring. We begin with the work of F.C. Auluck around 1940.

Perhaps spurred by the exciting results of his friend and collaborator S.S. Pillai, Sarvadaman Chowla encouraged Faqir Chand Auluck to apply the method of Vinogradov as modified by Gelbcke to Waring's problem for biquadrates. Auluck, who was born in 1912 in Jalandhar, Punjab, was then a lecturer at the Dyal Singh College, Lahore and had, not long before, secured the distinction of having obtained the first rank in both the B.A. and M.A. degree examinations of the Panjab University, Lahore. Auluck took up

Chowla's suggestion and in 1940 showed that every natural number n such that $\log_{10} \log_{10} n \geq 89$ is indeed a sum of 19 biquadrates [2].

Even if Auluck's bound was, by its author's own admission in the introduction to [2], far beyond the reach of any computing power so as to allow improvements on upper bounds for $g(4)$, it was cited for a long time as the only explicit bound known on the representation by 19 biquadrates. While he continued to work with Chowla and by himself on problems in number theory, Auluck subsequently became a physicist well-known for his work in Statistical Physics. He moved from Lahore to New Delhi where he was eventually Professor Emeritus and Aryabhata Professor of Physics at the University of Delhi. Professor F.C. Auluck died in 1987, aged 75.

In his thesis [74] of 1973, H.E. Thomas made explicit Davenport's refinement of Vinogradov's method in [27] to obtain remarkable gains in Waring's problems for biquadrates. In particular, he improved vastly upon Auluck's bound by showing that every natural number exceeding 10^{1409} is a sum of 19 biquadrates and also that every natural number exceeding 10^{568} is a sum of 22 biquadrates. From his bounds, Thomas concluded that $g(4) \leq 23$, thereby improving substantially on earlier results F.Dress and J.-R. Chen who had $g(4) \leq 30$ and $g(4) \leq 27$, respectively. In the following year, Thomas [75] revisited the problem, and this time by means of a superior ascent technique, he improved his result to $g(4) \leq 22$.

Referring the reader to Deshouillers [29] for a deeper discussion of the method of Thomas, we note that his results were still the best that were known in 1978, when Professor Ramachandra proposed to the author that he consider the problem of showing that $g(4) = 19$. Let us sketch the argument that is used in [4] to show that $g(4) \leq 21$. We caution the reader that in order to keep the following exposition simple, we shall be slightly lax with the details at various points. Here and below we shall write $e(z)$ to denote $e^{2\pi iz}$, for any complex number z .

When Vinogradov's method is implemented for biquadrates, we are eventually reduced to obtaining numerically explicit estimates for the sum

$$S = \sum_{n \leq P} e(\alpha n^4), \quad (52)$$

where α is a suitable point in $[0, 1]$, P is a given large positive integer lying in a given interval, say, between 10^{30} and 10^{53} . To estimate S , which is trivially bounded by P , one applies a device called Weyl's differencing process, originally due to Hermann Weyl in this context. This amounts to taking the square of the absolute value of both sides of (52), rearranging the terms and applying the triangle inequality so as to obtain

$$|S|^2 = \sum_{m, n \leq P} e(\alpha(m^4 - n^4)) \leq \sum_{|h| \leq P} \left| \sum_{n \leq P} e(\alpha((n+h)^4 - n^4)) \right|. \quad (53)$$

Let us note that the polynomial $(n+h)^4 - n^4$ is of degree 3 in the variable n . Thus by an application of Weyl differencing we have succeeded in reducing the estimation of an exponential sum whose phase is a polynomial of degree 4 to a sum of exponential sums with phases polynomials of degree 3. On now applying the Cauchy-Schwarz inequality we deduce from (53) that

$$|S|^4 \leq P \sum_{|h| \leq P} \left| \sum_{n \leq P} e(4\alpha hn^3 + \dots) \right|^2, \quad (54)$$

where we have written $4\alpha hn^3 + \dots$ to denote $(n+h)^4 - n^4$, whose leading terms as a polynomial in n is $4\alpha hn^3$. On now applying the Weyl differencing process to the inner sum on the right hand side of (54), we obtain

$$|S|^4 \leq P \sum_{|h_1| \leq P} \sum_{|h_2| \leq P} \left| \sum_{n \leq P} e(12\alpha h_1 h_2 n^2 + \dots) \right|. \quad (55)$$

A final application of the Cauchy-Schwarz inequality together with the Weyl differencing process gives us the inequality

$$|S|^8 \leq 4P^4 \sum_{|h_1| \leq P} \sum_{h_2 \leq P} \sum_{h_3 \leq P} \left| \sum_{n \leq P} e(24\alpha h_1 h_2 h_3 n + \dots) \right|. \quad (56)$$

Since the innermost sum on the right hand side of (56) has a linear phase, this may be summed as a geometric series. On then applying the triangle inequality and setting $h_1 h_2 h_3 = h$ we deduce that

$$|S|^8 \leq 4P^4 \sum_{h \leq P^3} d_3(h) \min \left(P, \frac{1}{\|24h\alpha\|} \right), \quad (57)$$

where $d_3(h)$ is the number of ways of writing h as a product of three integers with $d_3(0) = 4P^2$. Let us now recall that our aim is to obtain a numerically explicit upper bound for $|S|$ and therefore for the right hand side of (57). It turns out that at the point such a bound is required in Vinogradov's method we already have an estimate of the shape

$$\sum_{h \leq P^3} \min \left(P, \frac{1}{\|24h\alpha\|} \right) \leq C(P)P^3 \log P, \quad (58)$$

where $C(P)$ is an explicitly determined constant. Now, it is known and in fact easily seen, that for any $\epsilon > 0$ there is a constant $C(\epsilon)$ such that $d_3(h) \leq C(\epsilon)P^\epsilon$. On inserting this bound into (57) and using (58) we obtain a bound of the shape

$$|S| \leq C_1(\epsilon)P^{\frac{7}{8}+\epsilon} \quad (59)$$

for any $\epsilon > 0$. Unfortunately, however, when ϵ is small, the constant $C_1(\epsilon)$ turns out to be far too large in comparison to the size of P for such a bound to be of value. Put differently, our problem is to obtain a bound for $|S|$ that may well be worse than (59) asymptotically, that is, as $P \rightarrow +\infty$ but is better than (59) for the given range of P .

The method devised in [4] to address this problem proceeds by introducing an auxillary arithmetical function $f(n)$ in the Cauchy-Schwarz steps (54) and (56). Indeed, let $f(n)$ be any arithmetical function with $f(n) > 0$ for all natural numbers n . By means of the Cauchy-Schwarz inequality we then obtain from (53) that

$$|S|^4 \leq \left(\sum_{|h| \leq P} \frac{1}{f(h)} \right) \sum_{|h| \leq P} f(h) \left| \sum_{n \leq P} e(4\alpha hn^3 + \dots) \right|^2. \tag{60}$$

Let us denote the second sum over h on the right hand side of (60) by S_1 . Then an application of Weyl differencing yields

$$|S_1| \leq \sum_{|l| \leq P} f(l) \sum_{|k| \leq P} \left| \sum_{n \leq P} e(12\alpha lkn^2 + \dots) \right|. \tag{61}$$

On putting $h = lk$ we may rewrite the right hand side of the above inequality as

$$\sum_{|h| \leq P^2} \left(\sum_{\substack{lk=h \\ |l| \leq P \\ |k| \leq P}} f(l) \right) \left| \sum_{n \leq P} e(24\alpha lkn^2 + \dots) \right|. \tag{62}$$

By means of a final application of Cauchy-Schwarz inequality followed by Weyl differencing we obtain from the above relations that

$$|S|^8 \leq AB \sum_{|h| \leq P^3} \left(\sum_{\substack{lk=h \\ |l| \leq P^2, \\ |k| \leq P}} f(l)^2 \right) \min(P, \frac{1}{\|24\alpha h\|}), \tag{63}$$

where A and B are given by the relations

$$A = \left(\sum_{|h| \leq P} \frac{1}{f(h)} \right)^2, B = \sum_{|h| \leq P^2} \frac{1}{f(h)^2} \left(\sum_{\substack{lk=h, \\ |l| \leq P, \\ |k| \leq P}} f(l) \right)^2. \tag{64}$$

In summary, we have replaced $d_3(h)$ by the function

$$\sum_{\substack{lk=h \\ |l| \leq P^2, \\ |k| \leq P}} f(l)^2. \tag{65}$$

When f is chosen to be multiplicative, the above function may be easily estimated in terms of $\sum_{d|n} f^2(d)$. It turns out that a good choice for f is

$$f(n) = n^\beta \prod_{p|n} (1 - p^{-2\beta})^{\frac{1}{2}}, \quad (66)$$

for $n \geq 1$ and a β fixed depending on the range of values for P . With the aid of this device and the numerical computations of Thomas we cited earlier, it was thus possible to show $g(4) \leq 21$ – the claim $g(4) \leq 20$ made by the author in [6] was based on a bound given by Thomas, which Deshouillers [29] pointed out was not substantiated. Thus in 1979 with $g(4) \leq 21$ we were literally two steps away from $g(4) = 19$. Tantalisingly close but not yet there.

Fortunately for the author, Deshouillers and Dress were also working on this problem around the same time, based in part on a marvellous probabilistic idea of Deshouillers. It remained for Deshouillers to realize that our improvements were in fact in different parts of the problem and that a combination of our methods would yield $g(4) = 19$. Once this was checked, the result was announced in [7].

The ideas that went into the proof of $g(4) = 19$ have been recently applied to obtain an explicit version of Davenport's theorem that $G(4) = 16$. More precisely, Deshouillers, Kawada and Wooley [30] have combined these ideas with an ingenious use of a polynomial identity due to Kawada and Wooley [46] to show that every integer exceeding 10^{216} that is not divisible by 16 is a sum of 16 biquadrates. When taken together with the numerical work of Deshouillers, Hennecart and Landreau [31] this result implies the remarkable conclusion that every integer exceeding 13792 is a sum of at most 16 biquadrates, which is Theorem 1 of [30]. The reader will also find in the appendix of [30] a proof of $g(4) = 19$, that requires much less computational effort than earlier, based on the methods of that paper.

In our enthusiasm for a problem that occupied our attention for some years we have mostly hewed to a single path of progress through Waring's problem – that of determining the values of $g(k)$. Naturally there have been other developments, and indeed, in the recent years these developments have yielded extremely impressive results in Waring's problem on $G(k)$ and, more generally, in Diophantine problems to which the circle method has been applied. A proper description of these advances would, however, require another essay and other authors. We conclude by warmly recommending [12] and [77].

Acknowledgements

I am deeply indebted to D. Surya Ramana of Harish-Chandra Research Institute, Allahabad, without whose help it would have been impossible to write this article. I also wish to thank Sanoli Gun, J. Oesterlé, Prem Prakash Pandey, Gyan Prakash, Purusottam Rath, O. Ramaré and R. Thangadurai for their help

at various stages of preparation of this article. I am grateful to Dr. Mrs. Usha Rubugunday for kindly sharing with me some details of the life of Professor R.K. Rubugunday and to Professor Bambah for a conversation on the work of Professor F.C. Auluck.

References

- [1] S.D. Adhikari, *Some Omega Results and Related Questions in the Research Work of Pillai*, in R. Balasubramanian and R. Thangadurai, Eds., *Collected Works of S. Sivasankaranarayana Pillai*, Ramanujan Mathematical Society, 2010.
- [2] F.C. Auluck, On Waring's problem for Biquadrates, *Proc. Indian Academic of Sciences, Sec. A*, 11, 437–450, 1940.
- [3] R. Balasubramanian, *An improvement on a theorem of Titchmarsh on the mean square of $|\zeta(\frac{1}{2} + it)|$* . *Proc. London Math. Soc.* (3) 36 (1978), no. 3, 540–576.
- [4] R. Balasubramanian, *On Waring's problem: $g(4) \leq 21$* , *Hardy-Ramanujan Journal*, Vol. 2, 3–31, 1979.
- [5] R. Balasubramanian, *On the Frequency of Titchmarsh phenomenon for zeta(s) IV*, *Hardy-Ramanujan Journal*, Vol. 9, 1–10, 1986.
- [6] R. Balasubramanian, *On Waring's problem: $g(4) \leq 20$* . *Hardy-Ramanujan J.* 8, 1–40, 1985.
- [7] R. Balasubramanian, J.-M. Deshouillers, F. Dress, *Problème de waring pour les bicarrés 1: Schéma de la solution.*, *C.R. Acad. Sci. Paris., Sér. I math*, 303, 85–88, 1986.
- [8] R. Balasubramanian and K. Ramachandra, *On the Frequency of the Titchmarsh's Phenomenon for zeta(s). III*, *Proc. Indian Acad. Science*, 83, 156–165, 1976.
- [9] R. Balasubramanian, K. Ramachandra and M.V. Subba Rao, *On the error term in the asymptotic formula for the counting function of k-full numbers*, *Acta. Arith.*, Vol. 50, 107–118, 1988.
- [10] R. Balasubramanian and R. Thangadurai, Eds., *Collected Works of S. Sivasankaranarayana Pillai*, Ramanujan Mathematical Society, 2010.
- [11] Bruce Berndt and R.A. Rankin, *Ramanujan: Letters and Commentary*, American Mathematical Society and London Mathematical Society, 1995.
- [12] Timothy D. Browning, *Quantitative Arithmetic of Projective Varieties*, Vol. 277, *Progress in Mathematics*, Birkhauser, 2010.
- [13] S. Chandrasekhar, *On Ramanujan*, in *Ramanujan Revisited*, Academic Press, 1988.
- [14] K. Chandrasekharan, *Arithmetical Functions*, Grundlehren Series, Volume 167, Springer Verlag, 1970.
- [15] K. Chandrasekharan, *S.S. Pillai*, *J. Indian Math. Soc., (N.S.) Part A*, 15, 1–10, 1951.
- [16] K. Chandrasekharan, *T. Vijayaraghavan*, *Math. Student*, 24, 251–267, 1951.

-
- [17] K. Chandrasekharan and S. Meenakshisundaram, *Typical Means*, Tata Institute of Fundamental Research, 1950.
- [18] K. Chandrasekharan and Raghavan Narasimhan, *Hecke's functional equation and arithmetical identities*, Annals of Math., Vol. 74 1–23, 1961.
- [19] K. Chandrasekharan and Raghavan Narasimhan, *Functional equations with multiple gamma factors and the average order of arithmetical functions*, Annals of Math., 76, 93–196, 1962.
- [20] K. Chandrasekharan and Raghavan Narasimhan, *The approximate functional equation for a class of zeta-functions*, Math. Ann., 152, 30–64, 1963.
- [21] K. Chandrasekharan and Raghavan Narasimhan, *On the mean value of the error term for a class of arithmetical functions*, Acta Math., Vol. 112, 41–67, 1964.
- [22] K. Chandrasekharan and Raghavan Narasimhan, *On Lattice Points in Random Spheres*, Bulletin of the A.M.S., 68–71, Vol. 73, 1967.
- [23] J.-R. Chen, *Waring's problem for $g(5)$* , Sci. Scinica, 13, 1547–1568, 1964.
- [24] M.D. Coleman, The Hooley-Huxley contour method for problems in number fields. I. Arithmetic functions. J. Number Theory 74, no. 2, 250–277, 1999.
- [25] M.D. Coleman, The Hooley-Huxley contour method for problems in number fields. III. Frobenian functions. 21st Journ'ees Arithmétiques (Rome, 2001). J. Théor. Nombres Bordeaux 13, no. 1, 65–76, 2001.
- [26] M.D. Coleman, The Hooley-Huxley contour method, for problems in number fields. II. Factorization and divisibility. Mathematika 49 (2002), no. 1-2, 201–225, 2004.
- [27] H. Davenport, *On Waring's problem for fourth powers*, Annals of Mathematics, 40, 731–747, 1940.
- [28] H. Davenport, *T. Vijayaraghavan*, Journal Lond. Math. Soc., 33(2), 252–255, 1958.
- [29] J.-M. Deshouillers, *Problème de Waring pour les bicarrés: le point en 1984*, Paris Seminar, Tome 1, Exposé 33, 1–5, 1984–1985.
- [30] J.-M. Deshouillers, K. Kawada and T.D. Wooley, *On sums of sixteen biquadrates*, Mémoires de la Soc. Math. France, No. 100, 2005.
- [31] J.-M. Deshouiller, F. Hennecart and B. Landreau, *Waring's problem for sixteen biquadrates - Numerical Results*, J. Théor. Nombres Bordeaux, 12, 411–422, 2000.
- [32] L.E. Dickson, *Waring's problem and its generalizations*, Bulletin of the Amer. Math. Soc., 833–842, 1936.
- [33] P. Erdős, *Integers having exactly k prime factors*, Annals of Mathematics, Vol. 49, 53–66, 1948.
- [34] P. Erdős H. N. Shapiro, *On the changes of sign of a certain error function*, Canadian J. Math. 3, 375–385, 1951.
- [35] W.J. Ellison, *Waring's Problem*, American Math. Monthly, Vol. 78, 10–36, 1971.
- [36] G.H. Hardy, *An Extension of a Theorem on Oscillating Series*, Proc. London Math. Soc., Vol. 12, 174–180, 1913.

-
- [37] G.H. Hardy, *Ramanujan: Twelve lectures on Subjects Suggested by His Life and Work*, Cambridge University Press, 1940.
- [38] G.H. Hardy and S. Ramanujan, *The Normal Number of Prime Factors of a Number n* , Quarterly Journal of Mathematics, Vol. 48, 76–92, 1917.
- [39] G.H. Hardy and S. Ramanujan, *Asymptotic formulae in Combinatory Analysis*, Proc. London Math. Society, Vol. 17, 75–115, 1918.
- [40] G.H. Hardy and J.E. Littlewood, *Some problems of Partitio Numerorum IV: The singular series in Waring's problem and the value of the number $G(k)$* , Math. Zeit., 12, 161–188, 1922.
- [41] G.H. Hardy, P.V. Seshu Aiyar and B.M. Wilson, Eds., *Collected papers of Srinivasa Ramanujan*, Cambridge University Press, 1927.
- [42] G.H. Hardy and E.M. Wright, *Introduction to the Theory of Numbers*, Sixth Edition Revised by D.R. Heath-Brown and J.H. Silverman, Oxford University Press, 2008.
- [43] D. Hilbert, *Beweis für die Darstellbarkeit der ganzen Zahlen durch feste Anzahl n -ter Potenzen (Waringsches Problem)*, Math. Annalen, Vol. 67, 381–300, 1909.
- [44] J.G. Huard and K.S. Williams Eds., *The Collected Papers of Sarvadaman Chowla*, Volumes I to III, C.R.M., Canada, 1999.
- [45] J.G. Huard, *Sarvadaman Chowla (1907-1995)*, in *The Collected Papers of Sarvadaman Chowla*, Volumes I, iii–vi, C.R.M., Canada, 1999.
- [46] K. Kawada and T.D. Wooley, *Sums of Fourth Powers and Related Topics*, J. reine angew Math., 512, 173–223, 1999.
- [47] A. Kempner, *Bemerkungen zum Waringschen Problem*, Math. Annalen, Vol. 72, 387–397, 1912.
- [48] M. Kühleitner and W.G. Nowak, *An Omega theorem for a Class of Arithmetical Functions*, Math. Nach., 165, 79–98, 1994.
- [49] B. Ya. Levin, *Lectures on Entire Functions*, Translations of mathematical Monographs, Vol. 150, American Math. Soc., 1996.
- [50] M. Ram Murty, V. Kumar Murty and K.S. Williams, *The work of Sarvadaman Chowla*, in *The Collected Papers of Sarvadaman Chowla*, Volumes I, iii–vi, C.R.M., Canada, 1999.
- [51] Ivan Niven, *An Unsolved Case of the Waring Problem*, American Journal of Mathematics, Vol. 66, No. 1, 137–143, 1944.
- [52] M. L. N. Sarma, *On the error term of a certain sum*, Proc. Indian Acad. Sci. A3, 338, 1936.
- [53] S. Sivasankaranarayana Pillai, *On the number of numbers which contain a fixed number of prime factors*, Math. Student, Vol. 4, 250–251, 1929.
- [54] S. Sivasankaranarayana Pillai, *Report on Sathe's solution of a problem of Hardy's*, unpublished manuscript.
- [55] S. Sivasankaranarayana Pillai, *Symposium on Waring's Problem, Chairman's address*, Math. Student, VII, 165–168, 1939.
- [56] S. Sivasankaranarayana Pillai, *On Waring's Problem $g(6) = 73$* , Proceedings of Indian Academy of Sciences, Sect. A, 12, 30–20, 1940.

- [57] C.T. Rajagopal, *K. Ananda Rau*, Journal of London Math. Soc., Vol. 44, 1–6, 1969.
- [58] R.A. Rankin, *G.H. Hardy as I knew him*, in Number Theory for the Millennium, Volume 3, A.K. Peters Ltd., 2002.
- [59] K. Ananda Rau, *A Note on a Theorem of Mr. Hardy's*, Proc. London Math. Soc., Vol. 17, 334–336, 1918.
- [60] K. Ananda Rau, *On the Convergence and Summability of Dirichlet's Series*, Proc. London Math. Soc., Vol. 34, 414–440, 1932.
- [61] K. Ananda Rau, *The infinite product for $(s - 1)\zeta(s)$* , Math. Zeit., Vol. 20, 1–20, 1924.
- [62] M.S. Raghunathan, *Artless Innocents and Ivory Tower Sophisticates*, Current Science, Vol. 85, No. 3, 2003.
- [63] K. Ramachandra, *Applications of Kronecker's Limit Formulas*, Annals of Mathematics, Vol. 80, 104–148, 1964.
- [64] K. Ramachandra, *Some problems of analytic number theory, I*, Acta Arith., Vol. 31, 313–324, 1976.
- [65] K.G. Ramanathan, *C.P. Ramanujam*, in C.P. Ramanujam, a tribute, Tata Institute of Fundamental Research, 1978.
- [66] C.P. Ramanujam, *Cubic Forms over Algebraic Number Fields*, Proc. Camb. Phil. Soc., Vol. 39, 663–705, 1962.
- [67] C.P. Ramanujam, *Sums of m -th powers in p -adic rings*, Mathematika, 10, 137–146, 1963.
- [68] G.J. Rieger, *Zur Hilbertschen Lösung des Waringschen Problems: Abschätzung von $g(n)$* , Archiv der Math., Vol. 4, 275–281, 1953.
- [69] R.K. Rubugunday, *On $g(k)$ in Waring's problem*, Journal Indian Math. Soc. (2)6, 192–198, 1942.
- [70] S. Raghavan, *Professor K.G. Ramanathan (1920-1992)*, Acta Arith., Vol. 64(1), 1–4, 1993.
- [71] L.G. Sathe, *On a problem of Hardy*, J. Indian Mathematical Society, Vol. 17, 63–82, 83–141, 1953, Vol. 18, 27–42, 43–81, 1954.
- [72] A. Selberg, *Note on a paper of L.G. Sathe*, J. of the Indian Mathematical Society., Vol. 18, 83–87, 1954.
- [73] G. Tenenbaum, *Introduction to Analytic and Probabilistic Number Theory*, Cambridge Advanced Studies in Pure Mathematics, Vol. 46, Cambridge University Press, 1995.
- [74] H.E. Thomas, *A Numerical Approach to Waring's Problem for fourth powers*, Ph.D. Thesis, University of Michigan, 1973.
- [75] H.E. Thomas, *Waring's Problem for Twenty Two Biquadrates*, Trans. Amer. Math. Soc., 193, 427–430, 1974.
- [76] C.L. Siegel, *Advanced Analytic Number Theory*, Tata Institute of Fundamental Research Lecture Notes, 1980.

-
- [77] R.C. Vaughan and T.D. Wooley, *Waring's Problem: A Survey*, in Number Theory for the Millennium, Volume 3, 301–340, A.K. Peters Ltd., 2002.
- [78] T. Vijayaraghavan, *Periodic Simple Continued Fractions*, Proc. London Math. Soc., 26, 403–414, 1927.
- [79] T. Vijayaraghavan, *On the set of points $\{\phi(n)/n\}$* , J. Indian Math. Soc., 12, 98–99, 1920.
- [80] I.M. Vinogradov, *Ivan Matveevič Vinogradov Selected Works*, Springer Verlag, 1985.
- [81] I.M. Vinogradov, *On Waring's Theorem*, Izvestiya Akademii Nauk. SSSR, no. 4, 393–400, 1928.
- [82] I.M. Vinogradov, *On Waring's problem*, Annals of Mathematics, 36, 395–405, 1935.
- [83] P. Zarzycki, *Distribution of primes of imaginary quadratic fields in sectors*. J. Number Theory, Vol. 37, 152–160, 1991.

Endoscopy Theory of Automorphic Forms

Ngô Bao Châu*

Abstract

Historically, Langlands has introduced the theory of endoscopy in order to measure the failure of automorphic forms from being distinguished by their L -functions as well as the defect of stability in the Arthur-Selberg trace formula and ℓ -adic cohomology of Shimura varieties. However, the number of important achievements in the domain of automorphic forms based on the idea of endoscopy has been growing impressively recently. Among these, we will report on Arthur's classification of automorphic representations of classical groups and recent progress on the determination of ℓ -adic galois representations attached to Shimura varieties originating from Kottwitz's work. These results have now become unconditional; in particular, due to recent progress on local harmonic analysis. Among these developments, we will report on Waldspurger's work on the transfer conjecture and the proof of the fundamental lemma.

Mathematics Subject Classification (2010). Main: 11F70; Secondary: 14K10

Keywords. Automorphic forms, endoscopy, transfer conjecture, fundamental lemma, Hitchin fibration.

1. Langlands' Functoriality Conjecture

This section contains an introduction of the functoriality principle conjectured by Langlands in [39].

1.1. L -functions of Dirichlet and Artin. The proof by Dirichlet for the infiniteness of prime numbers in an arithmetic progression of the form $m + Nx$ for some fixed integers m, N with $(m, N) = 1$, was a triumph of

*Supported by the Institute for Advanced Study, the NSF and the Symoniy foundation.
School of Mathematics, Institute for Advanced Study, Princeton NJ 08540 USA.
Département de mathématiques, Université Paris-Sud, 91405 Orsay FRANCE.
E-mail: ngo@ias.edu

the analytic method in elementary number theory, *cf.* [13]. Instead of studying congruence classes modulo N which are prime to N , Dirichlet attached to each character $\chi : (\mathbb{Z}/N\mathbb{Z})^\times \rightarrow \mathbb{C}^\times$ of the group $(\mathbb{Z}/N\mathbb{Z})^\times$ of invertible elements in $\mathbb{Z}/N\mathbb{Z}$, the Euler product

$$L_N(s, \chi) = \prod_{p \nmid N} (1 - \chi(p)p^{-s})^{-1}. \quad (1)$$

This infinite product converges absolutely for all complex numbers s having real part $\Re(s) > 1$ and defines a holomorphic function on this domain of the complex plane. For $N = 1$ and trivial character χ , this function is the Riemann zeta function. As for the Riemann zeta function, general Dirichlet L -function has a meromorphic continuation to the whole complex plane. However, in contrast with the Riemann zeta function that has a simple pole at $s = 1$, the Dirichlet L -function associated with a non trivial character χ admits a holomorphic continuation. This property of holomorphicity was a key point in Dirichlet's proof for the infiniteness of prime numbers in an arithmetic progression. Another important property is the functional equation relating $L(s, \chi)$ and $L(1 - s, \bar{\chi})$.

Let $\sigma : \text{Gal}(\bar{\mathbb{Q}}/\mathbb{Q}) \rightarrow \mathbb{C}^\times$ be a finite order character of the Galois group of the field of rational numbers \mathbb{Q} . For each prime number p , we choose an embedding of the algebraic closure $\bar{\mathbb{Q}}$ of \mathbb{Q} into the algebraic closure $\bar{\mathbb{Q}}_p$ of the field of p -adic numbers \mathbb{Q}_p . This choice induces a homomorphism $\text{Gal}(\bar{\mathbb{Q}}_p/\mathbb{Q}_p) \rightarrow \text{Gal}(\bar{\mathbb{Q}}/\mathbb{Q})$ from the local Galois group at p to the global Galois group. The Galois group $\text{Gal}(\bar{\mathbb{F}}_p/\mathbb{F}_p)$ of the finite field \mathbb{F}_p is a canonical quotient of $\text{Gal}(\bar{\mathbb{Q}}_p/\mathbb{Q}_p)$. We have the exact sequence

$$1 \rightarrow I_p \rightarrow \text{Gal}(\bar{\mathbb{Q}}_p/\mathbb{Q}_p) \rightarrow \text{Gal}(\bar{\mathbb{F}}_p/\mathbb{F}_p) \rightarrow 1 \quad (2)$$

where I_p is the inertia group. Recall that $\text{Gal}(\bar{\mathbb{F}}_p/\mathbb{F}_p)$ is an infinite procyclic group generated by the substitution of Frobenius $x \mapsto x^p$ in $\bar{\mathbb{F}}_p$. Let the inverse of this substitution denote Fr_p .

Let $\sigma : \text{Gal}(\bar{\mathbb{Q}}/\mathbb{Q}) \rightarrow \mathbb{C}^\times$ be a character of finite order. For all but finitely many primes p , say for all $p \nmid N$ for some integer N , the restriction of σ to the inertia group I_p is trivial. In that case $\sigma(\text{Fr}_p) \in \mathbb{C}^\times$ is a well defined root of unity. Artin defines the L -function

$$L_N(s, \sigma) = \prod_{p \nmid N} (1 - \sigma(\text{Fr}_p)p^{-s})^{-1}. \quad (3)$$

Artin's reciprocity law implies the existence of a Dirichlet character χ such that

$$L_N(s, \chi) = L_N(s, \sigma). \quad (4)$$

As a consequence, the $L_N(s, \sigma)$ satisfies all the properties of the Dirichlet L -functions. In particular, it is holomorphic for nontrivial σ and it satisfies a functional equation with respect to the change of variables $s \leftrightarrow 1 - s$.

Finite abelian quotients of $\text{Gal}(\bar{\mathbb{Q}}/\mathbb{Q})$ correspond to finite abelian extensions of \mathbb{Q} . According to Kronecker-Weber's theorem, abelian extensions are obtained by adding roots of unity to \mathbb{Q} . Since general extensions of \mathbb{Q} are not abelian, it is natural to seek a non abelian generalization of Artin's reciprocity law.

Let $\sigma : \text{Gal}(\bar{\mathbb{Q}}/\mathbb{Q}) \rightarrow \text{GL}(n, \mathbb{C})$ be a continuous n -dimensional complex representation. Since Galois groups are profinite groups, the image of σ is a finite subgroup of $\text{GL}(n, \mathbb{C})$. There exists an integer N , such that for every prime $p \nmid N$, the restriction of σ to the inertia group I_p is trivial. In that case, $\sigma(\text{Fr}_p)$ is well defined in $\text{GL}(n, \mathbb{C})$, and its conjugacy class does not depend on the particular choice of embedding $\bar{\mathbb{Q}} \rightarrow \bar{\mathbb{Q}}_p$. The Artin L -function attached to σ is the Euler product

$$L_N(s, \sigma) = \prod_{p \nmid N} \det(1 - \sigma(\text{Fr}_p)p^{-s})^{-1}. \quad (5)$$

Again, this infinite product converges absolutely for a complex number s with real part $\Re(s) > 1$ and defines a holomorphic function on this domain of the complex plane. It follows from the Artin-Brauer theory of characters of finite groups that the Artin L -function has meromorphic continuation to the complex plane.

Conjecture 1 (Artin). *If σ is a nontrivial irreducible n -dimensional complex representation of $\text{Gal}(\bar{\mathbb{Q}}/\mathbb{Q})$, the L -function $L(s, \sigma)$ admits holomorphic continuation to the complex plane.*

The case $n = 1$ follows from Artin's reciprocity theorem and Dirichlet's theorem. The general case would follow from Langlands's conjectural nonabelian reciprocity law. According to this conjecture, it should be possible to attach to σ as above a cuspidal automorphic representation π of the group $\text{GL}(n)$ with coefficients in the ring of the adèles $\mathbb{A}_{\mathbb{Q}}$ so that the Artin L -function of σ has the same Eulerian development as the principal L -function attached to σ . According to the Tamagawa-Godement-Jacquet theory *cf.* [62, 17], the latter extends to an entire function on complex plane that satisfies a functional equation. In the case $n = 2$, if the image of σ is solvable, the reciprocity law was established by Langlands and Tunnel by means of the solvable base change theory. The case where the image of σ in $\text{PGL}_2(\mathbb{C}) = \text{SO}_3(\mathbb{C})$ is the nonsolvable group of symmetries of the icosahedron is not known in general, though some progress on this question has been made [64].

1.2. Elliptic curves. Algebraic geometry is a generous supply of representations of Galois groups. However, most interesting representations have ℓ -adic coefficients instead of complex coefficients. Any system of polynomial equations with rational coefficients, homogeneous or not, defines an algebraic variety. The groups of ℓ -adic cohomology attached to it are equipped with a continuous action of $\text{Gal}(\bar{\mathbb{Q}}/\mathbb{Q})$. In contrast with complex representations, ℓ -adic representations might not have finite image.

The study of the case of elliptic curves is the most successful so far. Let E be an elliptic curve defined over \mathbb{Q} . The first ℓ -adic cohomology group of E is a 2-dimensional \mathbb{Q}_ℓ -vector space equipped with a continuous action of $\text{Gal}(\bar{\mathbb{Q}}/\mathbb{Q})$. In other words, we have a continuous 2-dimensional ℓ -adic representation

$$\sigma_{E,\ell} : \text{Gal}(\bar{\mathbb{Q}}/\mathbb{Q}) \rightarrow \text{GL}(2, \mathbb{Q}_\ell) \quad (6)$$

for every prime ℓ . The \mathbb{Q} -elliptic curve E can be extended to a $\text{Spec}(\mathbb{Z}[N^{-1}])$ -elliptic curve E_N for some integer N , i.e. E can be defined by homogeneous equation with coefficients in $\mathbb{Z}[N^{-1}]$ such that for every prime $p \nmid N$, the reduction of E_N modulo p is an elliptic curve defined over the finite field \mathbb{F}_p . If $p \neq \ell$, this implies that the restriction of $\sigma_{E,\ell}$ to inertia I_p is trivial. It follows that the conjugacy class of $\sigma_{E,\ell}(\text{Fr}_p)$ in $\text{GL}(2, \mathbb{Q}_\ell)$ is well defined. The number of points on E_N with coefficients in \mathbb{F}_p is given by the Grothendieck-Lefschetz fixed points formula

$$|E_N(\mathbb{F}_p)| = 1 - \text{tr}(\sigma_{E,\ell}(\text{Fr}_p)) + p. \quad (7)$$

It follows that $\text{tr}(\sigma_{E,\ell}(\text{Fr}_p))$ is an integer independent of the prime ℓ . Since it is also known that $\det(\sigma_{E,\ell}(\text{Fr}_p)) = p$, the eigenvalues of $\sigma_E(\text{Fr}_p)$ are conjugate algebraic integers of eigenvalue $p^{1/2}$, independent of ℓ . We can therefore drop the ℓ in the expressions $\text{tr}(\sigma_{E,\ell}(\text{Fr}_p))$ and $\det(\sigma_{E,\ell}(\text{Fr}_p))$ as well as in the characteristic polynomial of $\sigma_{E,\ell}(\text{Fr}_p)$.

The L -function attached to the elliptic curve E is defined by Euler product

$$L_N(s, E) = \prod_{p \nmid N} \det(1 - \sigma_E(\text{Fr}_p)p^{-s})^{-1}. \quad (8)$$

Since the complex eigenvalues of $\sigma_E(\text{Fr}_p)$ are of complex absolute value $p^{1/2}$, the above infinite product is absolute convergent for $\Re(s) > 3/2$ and converges to a holomorphic function on this domain of the complex plane.

Shimura, Taniyama and Weil conjectured that there exists a weight two holomorphic modular form f whose L -function $L(s, E)$ has the same Eulerian development as $L_N(s, E)$ at the places $p \nmid N$. It follows, in particular, that $L(s, E)$ has a meromorphic continuation to the complex plane and it satisfies a functional equation. As it was shown by Frey and Ribet, a more spectacular consequence is the last Fermat's theorem is actually true. The Shimura-Taniyama-Weil conjecture is now a celebrated theorem of Wiles and Taylor [73, 63] in the semistable case. The general case is proved in [7].

The Shimura-Taniyama-Weil conjecture fits well with Langlands's reciprocity conjecture, *cf.* [39]. Though the main drive of Wiles's work consists of the theory of deformation of Galois representations, it needed as input the reciprocity law for solvable Artin representations $\sigma : \text{Gal}(\bar{\mathbb{Q}}/\mathbb{Q}) \rightarrow \text{GL}_2(\mathbb{C})$ that was proved by Langlands and Tunnell. The interplay between the p -adic theory of deformations of Galois representations and Langlands's functoriality principle should be a fruitful theme to reflect upon *cf.* [44].

1.3. The Langlands conjectures. Let G be a reductive group over a global field F which can be a finite extension of \mathbb{Q} or the field of rational functions of a smooth projective curve over a finite field. For each absolute value v on F , F_v denotes the completion of F with respect to v , and if v is nonarchimedean, \mathcal{O}_v denotes the ring of integers of F_v . Let \mathbb{A}_F denote the ring of adèles attached to F , defined as the restricted product of the F_v with respect to \mathcal{O}_v .

By discrete automorphic representation, we mean an irreducible representation of the group $G(\mathbb{A}_F)$, the group of adèles points of G , that occurs as a subrepresentation of

$$L^2(G(F)\backslash G(\mathbb{A}_F))_\chi \quad (9)$$

where χ is an unitary character of the center of G [6]. Such a representation can develop as a completed tensor product $\pi = \hat{\otimes}_v \pi_v$ where π_v are irreducible admissible smooth representations of $G(F_v)$ for all nonarchimedean place v . For almost all nonarchimedean place v , π_v has a unique $G(\mathcal{O}_v)$ -invariant line l_v . The Hecke algebra \mathcal{H}_v of compactly supported complex valued functions on $G(F_v)$ that are bi-invariant under the action of $G(\mathcal{O}_v)$ acts on that line. Assume that G is unramified at v then \mathcal{H}_v is a commutative algebra whose structure could be described in terms of a duality between reductive groups, [8].

Reductive groups over an algebraically closed field are classified by their root datum $(X^*, X_*, \Phi, \Phi^\vee)$, where X^* and X_* are the group of characters, respectively cocharacters of a maximal torus and $\Phi \subset X^*, \Phi^\vee \subset X_*$ are, respectively, the finite subset of roots and of coroots, *cf.* [61]. By the exchange of roots and coroots, we have the dual root datum which is the root datum of a complex reductive group \hat{G} . The reductive group G is defined over F and becomes split over a Galois extension E of F . The group $\text{Gal}(E/F)$ acts on the root datum of G in fixing a basis. It thus defines an action of $\text{Gal}(E/F)$ on the complex reductive group \hat{G} . The semi-direct product ${}^L G = \hat{G} \rtimes \text{Gal}(E/F)$ was introduced by Langlands and is known as the L -group attached to G , *cf.* [39].

Suppose G unramified at a nonarchimedean place v ; in other words, assume that the finite extension E is unramified over v . After a choice of embedding $E \rightarrow \bar{F}_v$, the Frobenius element $\text{Fr}_v \in \text{Gal}(\bar{F}_v/\mathbb{F}_v)$, where \mathbb{F}_v denotes the residue field of F_v , defines an element of $\text{Fr}_v \in \text{Gal}(E/F)$. There exists an isomorphism, known as the Satake isomorphism, between the Hecke algebra \mathcal{H}_v and the algebra of \hat{G} -invariant polynomial functions on the connected component $\hat{G} \rtimes \{\text{Fr}_v\}$ of ${}^L G = \hat{G} \rtimes \text{Gal}(E/F)$. The line l_v acted on by the Hecke algebra \mathcal{H}_v defines a semisimple element $s_v \in \hat{G} \rtimes \{\text{Fr}_v\}$ up to \hat{G} -conjugacy in this component.

Unramified representations of $G(F_v)$ are classified by semisimple \hat{G} -conjugacy classes in $\hat{G} \rtimes \{\text{Fr}_v\}$. In order to classify all irreducible admissible smooth representations of $G(F_v)$ for all non-archimedean v , Langlands introduced the group

$$L_{F_v} = W_{F_v} \times \text{SL}(2, \mathbb{C})$$

where W_{F_v} is the Weil group of F_v . The subgroup W_{F_v} of $\text{Gal}(\bar{F}_v/F_v)$ consists of elements whose image in $\text{Gal}(\bar{\mathbb{F}}_v/\mathbb{F}_v)$ is an integral power of Fr_v .

According to theorems of Laumon, Rapoport, and Stuhler in equal characteristic case, and Harris-Taylor and Henniart in unequal characteristic case, there is a natural bijection between the set of n -dimensional representations of L_{F_v} and the set of irreducible admissible smooth representations of $\text{GL}_n(F_v)$ preserving L -factors and ϵ -factors of pairs, [51, 20, 22, 23].

According to Langlands, there should be also a group L_F attached to the global field F such that automorphic representations of $\text{GL}_n(n, \mathbb{A}_F)$ are classified by n -dimensional complex representations of L_F . The hypothetical group L_F should be equipped with a surjective homomorphism to the Weil group W_F .

When F is the field of rational functions of a curve defined over a finite field \mathbb{F}_q , the situation is much better. Instead of complex representations of the hypothetical L -group L_F , one parametrizes automorphic representations by ℓ -adic representations of the Weil group W_F . Recall that in the function field case W_F is the subgroup of $\text{Gal}(\bar{F}/F)$ consisting of elements whose image in $\text{Gal}(\bar{\mathbb{F}}_q/\mathbb{F}_q)$ is an integral power of Fr_q . In a tour de force, Lafforgue proved that there exists a natural bijection between irreducible n -dimensional ℓ -adic representation of the Weil group W_F and cuspidal automorphic representations of $GL_n(\mathbb{A}_F)$ following a strategy initiated by Drinfeld, who settled the case $n = 2$ [14, 46, 47]. In the number fields case, only a part of ℓ -adic representations of W_F coming from motives should correspond to a part of automorphic representations.

Let us come back to the general case where G is a reductive group over a global field that can be either a number field or a function field. According to Langlands, automorphic representations should be partitioned into packets parametrized by conjugacy classes of homomorphisms $L_F \rightarrow {}^L G$ compatible with the projections to W_F . At non-archimedean places, irreducible admissible smooth representations of $G(F_v)$ should also be partitioned into finite packets parametrized by conjugacy of homomorphism $L_{F_v} \rightarrow \hat{G} \rtimes W_{F_v}$ compatible with the projections to W_{F_v} . The parametrization of the local component of an automorphic representation should derive from the global parametrization by the homomorphism $L_{F_v} \rightarrow L_F$ that is only well defined up to conjugation.

This reciprocity conjecture on global parametrization of automorphic representations seems for the moment out of reach, in particular because of the hypothetical nature of the group L_F . In contrast, Langlands' functoriality conjecture is not dependent on the existence of L_F .

Conjecture 2 (Langlands). *Let H and G be reductive groups over a global field F and let ϕ be a homomorphism between their L -groups ${}^L H \rightarrow {}^L G$ compatible with projection to W_F . Then for each automorphic representation π_H of $H(\mathbb{A}_F)$, there exists an automorphic representation π of $G(\mathbb{A}_F)$ such that at each unramified place v where π_H is parametrized by a conjugacy class $s_v(\pi_H)$ in $\hat{H} \rtimes \{\text{Fr}_v\}$, the local component of π is also unramified and parametrized by $\phi(s_v(\pi_H))$.*

At least in the number field case, the existence of L_F seems to depend upon the validity of the functoriality principle. Some of the most important conjectures in number theory and in the theory of automorphic representations. As explained in [39], Artin conjecture follows from the case of functoriality when \hat{H} is trivial. It is also explained in loc. cit how the generalized Ramanujan conjecture and the generalized Sato-Tate conjecture would also follow from the functoriality conjecture.

The approach based on a combination of the converse theorem of Cogdell and Piatetski-Shapiro, and the Langlands-Shahidi method was successful in establishing some startling cases of functoriality beyond endoscopy, *cf.* [26]. However, it suffers obvious limitation as Langlands-Shahidi method is based on the representation of a Levi component of a parabolic group on the Lie algebra of its unipotent radical.

Recently, the p -adic method was also successful in establishing a weak form of the functoriality conjecture. The most spectacular result is the proof of the Sato-Tate conjecture [21] deriving from this weak form. We will not discuss this topic in this survey.

So far, the most successful method in establishing special cases of functoriality is endoscopy. We will discuss this topic in more details in the next section.

2. Endoscopy Theory and Applications

The endoscopy theory is primarily focused in the structure of the packet of representations that have the same conjectural parametrization, either global $L_F \rightarrow {}^L G$ or local $L_{F_v} \rightarrow \hat{G} \rtimes W_{F_v}$. The existence of the packet is closely related to the lack of stability in the trace formula. As shown in [42], the answer to this question derives from the comparison of trace formulas. It is quite remarkable that the inconvenient unstability in the trace formula turned out to be a possibility. The quest for a stable trace formula bringing the necessity of comparing two trace formulas, turned out to be an efficient tool for establishing particular cases of functoriality.

A good number of known cases of functoriality fits into a general scheme that is nowadays known as the theory of endoscopy and twisted endoscopy: Jacquet-Langlands theory, solvable base change, automorphic induction and the Arthur lift from classical groups to linear groups.

Another source of endoscopic phenomenon was the study of continuous cohomology of Shimura varieties as first recognized by Langlands [40]. The work of Kottwitz has definitely shaped this theory by proposing precise conjecture on the ℓ -adic cohomology of Shimura variety as Galois module [34]. This description has been established in many important cases by means of comparison of the Grothendieck-Lefschetz fixed points formula and the Arthur-Selberg trace formula.

2.1. Packets of representations. First intuitions of endoscopy come from the theory of representations of $\mathrm{SL}(2, \mathbb{R})$. The restriction of discrete series representations of $\mathrm{GL}(2, \mathbb{R})$ to $\mathrm{SL}(2, \mathbb{R})$ is reducible. Their irreducible factors having the same Langlands parameter obtained by composition $W(\mathbb{R}) \rightarrow \mathrm{GL}(2, \mathbb{C}) \rightarrow \mathrm{PGL}(2, \mathbb{C})$ and thus belong to the same packet. Packet of representations is understood to be dual stable conjugacy relation between conjugacy classes. For instance, the rotations of angle θ and $-\theta$ centered at the origin of the plane are not conjugate in $\mathrm{SL}(2, \mathbb{R})$, but become conjugate either in $\mathrm{GL}(2, \mathbb{R})$ or in $\mathrm{SL}(2, \mathbb{C})$.

In general, if G is a quasi-split reductive group over a local field F_v , and $\Pi_v(G)$ is the set of irreducible representations of G , Langlands conjectured that $\Pi(G)$ is a disjoint union of finite sets $\Pi_{v, \phi}(G)$ that are called L -packets and indexed by admissible homomorphisms $\phi_v : L_{F_v} \rightarrow {}^L G_v$. The work of Shelstad [59] in the real case suggested the following description of the set $\Pi_v(G)$ in general, *cf.* [42].

Let S_{ϕ_v} denote the centralizer of the image of ϕ_v in \hat{G} , and $S^0(\phi_v)$ its neutral component. Let $Z(\hat{G})$ denote the center of $Z(\hat{G})$ and $Z(\hat{G})^\Gamma$ denote the subgroup of invariants under the action of the Galois group Γ . The group $\mathcal{S}_{\phi_v} = S_{\phi_v}/S_{\phi_v}^0 Z(\hat{G})^\Gamma$ should control completely the structure of the finite set Π_{ϕ_v} and also the characters of the representations belonging to Π_{ϕ_v} . If we further assume ϕ_v tempered, i.e. its image is contained in a relatively compact subset of \hat{G} , then there should be a bijection $\pi \mapsto \langle s, \pi \rangle$ from Π_{ϕ_v} onto the set of irreducible characters of \mathcal{S}_{ϕ_v} . In particular, the cardinal of the finite set Π_{ϕ_v} should equal the number of conjugacy classes of \mathcal{S}_{ϕ_v} .

There is also a conjectural description of multiplicity in the automorphic spectrum of each member of a global L -packet. We can attach any admissible homomorphism $\phi : L_F \rightarrow {}^L G$ local parameter $\phi_v : L_{F_v} \rightarrow {}^L G_v$. By definition, the global L -packet Π_ϕ is the infinite product of local L -packets Π_{ϕ_v} . For a representation $\pi = \otimes_v \pi_v$ with $\pi_v \in \Pi_v$ to appear in the automorphic spectrum, all but finitely many local components must be unramified. For those representations, there is a conjectural description of its automorphic multiplicity $m(\pi, \phi)$ that was made precise by Kottwitz based on the case of SL_2 worked out by Labesse and Langlands *cf.* [38]. In [31], Kottwitz introduced a group \mathcal{S}_ϕ equipped with homomorphism $\mathcal{S}_\phi \rightarrow \mathcal{S}_{\phi_v}$. The conjectural formula for $m(\pi, \phi)$ is

$$m(\pi, \phi) = |\mathcal{S}_\phi|^{-1} \sum_{\epsilon \in \mathcal{S}_\phi} \prod_v \langle \epsilon_v, \pi_v \rangle.$$

For each v , ϵ_v denotes the image of ϵ in \mathcal{S}_{ϕ_v} and $\langle \epsilon_v, \pi_v \rangle$, the value of the character of \mathcal{S}_{ϕ_v} corresponding to π_v evaluated on ϵ_v .

If the above general description has an important advantage of putting the automorphic theory in perspective, it also suffers a considerable inconvenience of being dependent on the hypothetical Langlands group L_F .

For quite a long time, we have known only a few low rank cases including the case of inner forms of $\mathrm{SL}(2)$ due to Labesse and Langlands [38], the

cyclic base change for $\mathrm{GL}(2)$ due to Saito, Shintani and Langlands [41] and the case of $U(3)$ and its base change due to Rogawski [58]. Later, the cyclic base change for $\mathrm{GL}(n)$ was established by Arthur and Clozel [3]. Recently, this field has been undergoing spectacular developments. For quasisplit classical groups, Arthur has been able to establish the existence and the description of local packets as well as an automorphic multiplicity formula for global packets [2]. For p -adic groups, the local description becomes unconditional based on the local Langlands conjecture for $\mathrm{GL}(n)$ proved by Harris-Taylor and Henniart. Arthur's description of global packet as well as his automorphic multiplicity formula is based on cuspidal automorphic representations of $\mathrm{GL}(n)$ instead of the hypothetical group L_F . This description relies on a little bit of intricate combinatorics that goes beyond the scope of this report. The unitary case was also settled by Mœglin [52], the case of inner forms of $\mathrm{SL}(n)$ by Hiraga and Saito [24]. The general case of Jacquet-Langlands correspondence has been also established by Badulescu [4].

Most of the above developments were made possible by the formidable machine that is the Arthur trace formula and its stabilization. The comparison of the trace formula for two different groups, one being endoscopic to the other, proved to be a quite fruitful method. Arthur's parametrization of automorphic forms on quasisplit classical groups derives from the possibility of realizing these groups as twisted endoscopic groups of $\mathrm{GL}(n)$ and the comparison between the twisted trace formula of $\mathrm{GL}(n)$ and the ordinary trace formula for the classical group. This procedure is known as the stabilization of the twisted trace formula. The structure of the L -packets derives from the stabilization of ordinary trace formula for classical groups. For both twisted and untwisted, Arthur needed to assume the validity of certain conjectures on orbital integrals: the transfer and the fundamental lemma.

2.2. Construction of Galois representations. Based on indications given in Shimura's work, Langlands proposed a general strategy to constructing Galois representations attached to automorphic representation incorporated in ℓ -adic cohomology of Shimura varieties. This domain also recorded important developments due to Kottwitz, Clozel, Harris, Taylor, Yoshida, Labesse, Morel, Shin and others.

In particular, a non negligible portion of the global Langlands correspondence for number fields is now known. A number field F is of complex multiplication if it is a totally imaginary quadratic extension of a totally real number field F^+ . In particular, the complex conjugation induces an automorphism c of F that is independent of complex embedding of F . Let $\Pi = \bigotimes_v \Pi_v$ be a cuspidal automorphic representation of $\mathrm{GL}(n, \mathbb{A}_F)$ such that $\Pi^\vee \simeq \Pi \circ c$, whose component at infinity Π_∞ has the same infinitesimal character as some irreducible algebraic representation satisfying certain regularity condition. Then for every prime number ℓ , there exists a continuous representation $\sigma : \mathrm{Gal}(\bar{F}/F) \rightarrow \mathrm{GL}(n, \mathbb{Q}_\ell)$ so that for every prime p of F that does

not lie above ℓ , the local component π_v of π corresponds to the ℓ -adic local representation of $\text{Gal}(\bar{F}_v/F_v)$ via the local Langlands correspondence established by Harris-Taylor and Henniart. This important theorem is due to Clozel, Harris, and Labesse [11], Morel [53] and Shin [60] with some difference in the precision.

Under the above assumptions on the number field F and the automorphic representation Π , there exists a unitary group $U(F^+)$ with respect to the quadratic extension F/F^+ that gives rise to a Shimura variety and an automorphic representation π of U whose base change to $\text{GL}(n, F)$ is Π . The base change from the unitary group U to the linear group $\text{GL}(n, F)$ is a case of the theory of twisted endoscopy. It is based on a comparison of the twisted trace formula for $\text{GL}(n, F)$ and the ordinary trace formula for $U(F^+)$. For more details, see [10, 37].

Following the work of Kottwitz on Shimura varieties, it is possible to attach Galois representation to automorphic forms. Algebraic cuspidal automorphic representations of unitary group appears in ℓ -adic cohomology of Shimura variety. In [35], Kottwitz proved a formula for the number of points on certain type of Shimura varieties with values in a finite field at a place of good reduction, and in [34], he showed how to stabilize this formula in a very similar manner to the stabilization of the trace formula. He also needed to assume the validity of the same conjectures on local orbital integrals as in the case of stabilization of the trace formula.

Kottwitz' formula for the number of points allow to show the compatibility with the local correspondence at the unramified places. More recently, Shin proved a formula for fixed points on Igusa varieties that looks formally similar to Kottwitz' formula that allows him to prove the compatibility with the local correspondence at a ramified place [60].

Morel was able to calculate the intersection cohomology of non-compact unitary Shimura varieties when the other authors confined themselves in the compact case [53]. The description of the intersection cohomology has been conjectured by Kottwitz.

We observe the remarkable similarity between Arthur's works on the classification of automorphic representations of classical groups and the construction of Galois representations attached to automorphic representations by Shimura varieties. Both need the stabilization of a twisted trace formula and of an ordinary trace formula or similar formula thereof.

3. Stabilization of the Trace Formula

The main focus of the theory of endoscopy is the stabilization of the trace formula. The trace formula allows us to derive properties of automorphic representations from a careful study of orbital integrals. The orbital side of the trace formula is not stable but the defect of stability can be expressed by an endoscopic group. It follows the endoscopic case of the functoriality conjecture.

This section will give more details about the stabilization of the orbital side of the trace formula.

3.1. Trace formula and orbital integrals. In order to simplify the exposition, we will consider only semisimple groups G defined over a global field F . The Arthur-Selberg trace formula for G has the following form

$$\sum_{\gamma \in G(F)/\sim} \mathbf{O}_\gamma(f) + \cdots = \sum_{\pi} \mathrm{tr}_\pi(f) + \cdots \quad (10)$$

where γ runs over the set of anisotropic conjugacy classes of $G(F)$ and π over the set of discrete automorphic representations. The trace formula contains also more complicated terms related to hyperbolic conjugacy classes on one side and the continuous spectrum on the other side.

The test function f is of the form $f = \bigotimes_v f_v$ where for v , f_v is a smooth compactly supported function on $G(F_v)$ and for almost all nonarchimedean places v , f_v the unit function of the unramified Hecke algebra of $G(F_v)$. The global orbital integral

$$\mathbf{O}_\gamma(f) = \int_{I_\gamma(F) \backslash G(\mathbb{A})} f(g^{-1}\gamma g) dg \quad (11)$$

is convergent for anisotropic conjugacy classes $\gamma \in G(F)$. Here $I_\gamma(F)$ is the discrete group of F -points on the centralizer I_γ of γ . After choosing a Haar measure $dt = \bigotimes dt_v$ on $I_\gamma(\mathbb{A})$, we can express the above global integral as follows

$$\mathbf{O}_\gamma(f) = \mathrm{vol}(I_\gamma(F) \backslash I_\gamma(\mathbb{A}), dt) \prod_v \mathbf{O}_\gamma(f_v, dg_v/dt_v). \quad (12)$$

The torus I_γ has an integral form well defined up to finitely many places, and the measure dt is chosen so that $I_\gamma(\mathcal{O}_v)$ has volume one for almost all v . Over a nonarchimedean place, the local orbital integral

$$\mathbf{O}_\gamma(f_v, dg_v/dt_v) = \int_{I_\gamma(F_v) \backslash G(F_v)} f(g^{-1}\gamma g) \frac{dg_v}{dt_v} \quad (13)$$

is defined for every locally constant function $f_v \in C_c^\infty(G(F_v))$ with compact support. Local orbital integral $\mathbf{O}_\gamma(f_v, dg_v/dt_v)$ is convergent for every v and equals 1 for almost all v . The volume term is finite when the global conjugacy class γ is anisotropic.

Arthur introduced a truncation operator to deal with the continuous spectrum in the spectral expansion and hyperbolic conjugacy classes in the geometric expansion. In the geometric expansion, Arthur has more complicated local integrals that he calls weighted orbital integrals, see [2].

3.2. Stable orbital integrals. For $\mathrm{GL}(n)$, two regular semisimple elements in $\mathrm{GL}(n, F)$ are conjugate if and only if they are conjugate in $\mathrm{GL}(n, \bar{F})$, where \bar{F} is an algebraic closure of F and this latter condition is tantamount to request that γ and γ' have the same characteristic polynomial. For a general reductive group G , we also have a characteristic polynomial map $\chi : G \rightarrow T/W$ where T is a maximal torus and W is its Weyl group. An element is said to be strongly regular semisimple if its centralizer is a torus. Strongly regular semisimple elements $\gamma, \gamma' \in G(\bar{F})$ have the same characteristic polynomial if and only if they are $G(\bar{F})$ -conjugate. However, there are possibly more than one $G(F)$ -conjugacy classes within the set of strongly regular semisimple elements having the same characteristic polynomial in $G(F)$. These conjugacy classes are said to be stably conjugate.

Let $\gamma, \gamma' \in G(F)$ be such that there exist $g \in G(\bar{F})$ with $\gamma' = g\gamma g^{-1}$. For all $\sigma \in \mathrm{Gal}(\bar{F}/F)$, since γ, γ' are defined over F , $\sigma(g)^{-1}g$ belongs to the centralizer of γ . The map

$$\sigma \mapsto \sigma(g)^{-1}g \quad (14)$$

defines a cocycle with values in $I_\gamma(\bar{F})$ whose image in $G(\bar{F})$ is a boundary. For a fixed $\gamma \in G(F)$, assumed strongly regular semisimple, the set of $G(F)$ -conjugacy classes in the stable conjugacy class of γ can be identified with the subset A_γ of elements $\mathrm{H}^1(F, I_\gamma)$ whose image in $\mathrm{H}^1(F, G)$ is trivial. For local fields, the group $\mathrm{H}^1(F, I_\gamma)$ is finite but for global field, it can be infinite.

For a local non-archimedean field F , A_γ is a subgroup of the finite abelian group $\mathrm{H}^1(F, I_\gamma)$. One can form linear combinations of orbital integrals within a stable conjugacy class using characters of A_γ . In particular, the stable orbital integral

$$\mathbf{SO}_\gamma(f) = \sum_{\gamma'} \mathbf{O}_{\gamma'}(f)$$

is the sum over a set of representatives γ' of conjugacy classes within the stable conjugacy class of γ . One needs to choose in a consistent way Haar measures on different centralizers $I_{\gamma'}(F)$. For strongly regular semisimple γ , the tori $I_{\gamma'}$ for γ' in the stable conjugacy class of γ , are in fact canonically isomorphic, so that we can transfer a Haar measure from $I_\gamma(F)$ to $I_{\gamma'}(F)$. Obviously, the stable orbital integral \mathbf{SO}_γ depends only on the characteristic polynomial of γ . If a is the characteristic polynomial of a strongly regular semisimple element γ , we set $\mathbf{SO}_a = \mathbf{SO}_\gamma$. A stable distribution is an element in the closure of the vector space generated by the distributions of the forms \mathbf{SO}_a with respect to the weak topology.

In some sense, stable conjugacy classes are more natural than conjugacy classes. In order to express the difference between orbital integrals and stable orbital integrals, one needs to introduce other linear combinations of orbital integrals known as κ -orbital integrals. For each character $\kappa : A_\gamma \rightarrow \mathbb{C}^\times$, κ -orbital

integral is a linear combination

$$\mathbf{O}_\gamma^\kappa(f) = \sum_{\gamma'} \kappa(\text{cl}(\gamma')) \mathbf{O}_{\gamma'}(f)$$

over a set of representatives γ' of conjugacy classes within the stable conjugacy class of γ , $\text{cl}(\gamma')$ being the class of γ' in A_γ . For any γ' in the stable conjugacy class of γ , A_γ and $A_{\gamma'}$ are canonical isomorphic so that the character κ on A_γ defines a character of $A_{\gamma'}$. Now, \mathbf{O}_γ^κ and $\mathbf{O}_{\gamma'}^\kappa$ are not equal but differ by the scalar $\kappa(\text{cl}(\gamma'))$ where $\text{cl}(\gamma')$ is the class of γ' in A_γ . Even though this transformation rule is simple enough, we can't a priori define κ -orbital \mathbf{O}_a^κ for a characteristic polynomial a as in the case of stable orbital integral. This is a source of an important technical difficulty in the theory of endoscopy: the transfer factor.

3.3. Stable distributions and the trace formula. Test functions for the trace formula are finite combination of functions f on $G(\mathbb{A})$ of the form $f = \bigotimes_{v \in |F|} f_v$ where for all v , f_v is a smooth function with compact support on $G(F_v)$ and for almost all finite place v , f_v is the characteristic function of $G(\mathcal{O}_v)$ with respect to an integral form of G which is well defined almost everywhere.

The trace formula defines a linear form in f . For each v , it induces an invariant linear form in f_v . There exists a Galois theoretical cohomological obstruction that prevents this linear form from being stably invariant. Let $\gamma \in G(F)$ be a strongly regular semisimple element. Let $(\gamma'_v) \in G(\mathbb{A})$ be an adelic element with γ'_v stably conjugate to γ for all v and conjugate for almost all v . There exists a cohomological obstruction that prevents the adelic conjugacy class (γ'_v) from being rational. In fact the map

$$H^1(F, I_\gamma) \rightarrow \bigoplus_v H^1(F_v, I_\gamma) \tag{15}$$

is not surjective in general. Let \hat{I}_γ denote the dual complex torus of I_γ equipped with a finite action of the Galois group $\Gamma = \text{Gal}(\bar{F}/F)$. For each place v , the Galois group $\Gamma_v = \text{Gal}(\bar{F}_v/F_v)$ of the local field also acts on \hat{I}_γ . By local Tate-Nakayama duality as reformulated by Kottwitz, $H^1(F_v, I_\gamma)$ can be identified with the group of characters of $\pi_0(\hat{I}_\gamma^{\Gamma_v})$. By global Tate-Nakayama duality, an adelic class in $\bigoplus_v H^1(F_v, I_\gamma)$ comes from a rational class in $H^1(F, I_\gamma)$ if and only if the corresponding characters on $\pi_0(\hat{I}_\gamma^{\Gamma_v})$, after restriction to $\pi_0(\hat{I}_\gamma^\Gamma)$, sum up to the trivial character. The original problem with conjugacy classes within a stable conjugacy class, complicated by the presence of the strict subset A_γ of $H^1(F, I_\gamma)$, was solved in Langlands [42] and in a more general setting by Kottwitz [32].

In [42], Langlands outlined a program to derive from the usual trace formula a stable trace formula. The key point is to apply Fourier transform on the finite group $\pi_0(\hat{I}_\gamma^\Gamma)$ and the part of the trace formula corresponding to the stable conjugacy class of γ becomes a sum over the group of characters of $\pi_0(\hat{I}_\gamma^\Gamma)$.

By definition, the term corresponding to the trivial character of $\pi_0(\hat{I}_\gamma^F)$ is the stable trace formula. The other terms can be expressed as product of κ -orbital integrals.

Langlands conjectured that these κ -orbital integrals can also be expressed in terms of stable orbital integrals of endoscopic groups. The precise constant occurring in these conjectures were worked out in his joint work with Shelstad *cf.* [45]. There are in fact two conjectures: the transfer and the fundamental lemma that we will review in a similar but simpler context of Lie algebras. Admitting these conjectures, Langlands and Kottwitz proved that the correction terms in the elliptic part match with the stable trace formula for endoscopic groups. This equality is known under the name of the stabilization of the elliptic part of the trace formula.

The whole trace formula was eventually stabilized by Arthur under more local assumptions that are the weighted transfer and the weighted fundamental lemma *cf.* [1]. Arthur's classification of automorphic forms of quasisplit classical groups depends upon the stabilization of twisted trace formula. For this purpose, Arthur's local assumptions are more demanding: the twisted weighted transfer and the twisted weighted fundamental lemma.

3.4. The transfer and the fundamental lemma. We will state the two conjectures about local orbital integrals known as the transfer conjecture and the fundamental lemma in the case of Lie algebra. The statements in the case of Lie group are very similar but the constant known as the transfer factor more complicated.

Assume for simplicity that G is a split group over a local non-archimedean field F . Let \hat{G} denote the connected complex reductive group whose root system is related to the root system of G by exchanging roots and coroots. Let γ be a regular semisimple F -point on the Lie algebra \mathfrak{g} of G . Its centralizer I_γ is a torus defined over F . By the Tate-Nakayama duality, a character κ of $H^1(F, I_\gamma)$ corresponds to a semisimple element of \hat{G} that is well defined up to conjugacy. Let \hat{H} be the neutral component of the centralizer of κ in \hat{G} . For a given torus I_γ , we can define an action of the Galois group of F on \hat{H} that factors through the component group of the centralizer of κ in \hat{G} . By duality, we obtain a quasi-split reductive group H over F which is an endoscopic group of G .

The endoscopic group H is not a subgroup of G in general. Nevertheless, it is possible to transfer stable conjugacy classes from H to G , and from the Lie algebra $\mathfrak{h} = \text{Lie}(H)$ to \mathfrak{g} . Assume for simplicity that H is also split. The inclusion $\hat{H} = \hat{G}_\kappa \subset \hat{G}$ induces an inclusion of Weyl groups $W_H \subset W$. It follows that there exists a canonical map $\mathfrak{t}/W_H \rightarrow \mathfrak{t}/W$ that realizes the transfer of stable conjugacy classes from \mathfrak{h} to \mathfrak{g} . If $\gamma_H \in \mathfrak{h}(F)$ has characteristic polynomial $a_H \in \mathfrak{t}/W_H(F)$ mapping to the characteristic polynomial a of $\gamma \in G(F)$, we will say that the stable conjugacy class of γ_H transfers to the stable conjugacy class of γ .

Kostant has constructed a section $\mathfrak{t}/W \rightarrow \mathfrak{g}$ of the characteristic polynomial morphism $\mathfrak{g} \rightarrow \mathfrak{t}/W$ cf. [29]. For every $a \in (\mathfrak{t}/W)(F)$, the Kostant section defines a distinguished conjugacy class with the stable conjugacy class of a . As showed by Kottwitz cf. [36], the Kostant section provides us a rather simple definition of the Langlands-Shelstad transfer factor in the case of Lie algebra. Let $\Delta(\gamma_H, \gamma)$ be the unique complex function depending on regular semisimple conjugacy classes $\gamma_H \in \mathfrak{h}(F)$ and $\gamma \in \mathfrak{g}(F)$ with the characteristic polynomial $a_H \in (\mathfrak{t}/W_H)(F)$ of γ_H mapping to the characteristic polynomial $a \in (\mathfrak{t}/W)(F)$ of γ and satisfying the following property

- $\Delta(\gamma_H, \gamma)$ depends only on the stable conjugacy class of γ_H ,
- if γ and γ' are stably conjugate then $\Delta(\gamma_H, \gamma') = \langle \text{inv}(\gamma, \gamma'), \kappa \rangle \Delta(\gamma_H, \gamma)$ where $\text{inv}(\gamma, \gamma')$ is the cohomological invariant lying in $H^1(F, I_\gamma)$ defined by the cocycle (14),
- if γ is conjugate to the Kostant section at a , $\Delta(\gamma_H, \gamma) = |\Delta_G(\gamma)^{-1} \Delta_H(\gamma_H)|^{1/2}$ where Δ_G, Δ_H are the usual discriminant functions on \mathfrak{g} and \mathfrak{h} and $|\cdot|$ denotes the standard absolute value of the non-archimedean field F .

Conjecture 3 (Transfer). *For every $f \in C_c^\infty(G(F))$ there exists $f^H \in C_c^\infty(H(F))$ such that*

$$\text{SO}_{\gamma_H}(f^H) = \Delta(\gamma_H, \gamma) \mathbf{O}_\gamma^\kappa(f) \quad (16)$$

for all strongly regular semisimple elements γ_H and γ with the characteristic polynomial $a_H \in (\mathfrak{t}/W_H)(F)$ of γ_H mapping to the characteristic polynomial $a \in (\mathfrak{t}/W)(F)$ of γ .

Under the assumption γ_H and γ regular semisimple with the characteristic polynomial $a_H \in (\mathfrak{t}/W_H)(F)$ of γ_H mapping to the characteristic polynomial $a \in (\mathfrak{t}/W)(F)$ of γ , their centralizers in H and G are canonically isomorphic tori. We can therefore transfer Haar measures between those locally compact groups.

Assume that we are in unramified situation i.e. both G and H have reductive models over \mathcal{O}_F . Let $1_{\mathfrak{g}(\mathcal{O}_F)}$ be the characteristic function of $\mathfrak{g}(\mathcal{O}_F)$ and $1_{\mathfrak{h}(\mathcal{O}_F)}$ the characteristic function of $\mathfrak{h}(\mathcal{O}_F)$.

Conjecture 4 (Fundamental lemma). *The equality (16) holds for $f = 1_{\mathfrak{g}(\mathcal{O}_F)}$ and $f^H = 1_{\mathfrak{h}(\mathcal{O}_F)}$.*

In the case of Lie group instead of Lie algebra, there is a more general version of the fundamental lemma. Let \mathcal{H}_G be the algebra of $G(\mathcal{O}_F)$ -biinvariant functions with compact support on $G(F)$ and \mathcal{H}_H the similar algebra for $H(F)$. Using Satake isomorphism, we have a canonical homomorphism $b : \mathcal{H}_G \rightarrow \mathcal{H}_H$.

Conjecture 5. *The equality (16) holds for any $f \in \mathcal{H}_G$ and for $f^H = b(f)$.*

In [68], Waldspurger also stated another beautiful conjecture in the same spirit. Let G_1 and G_2 be two semisimple groups with isogeneous root systems i.e. there exists an isomorphism between their maximal tori which maps a root of G_1 on a scalar multiple of a root of G_2 and conversely. In this case, there is an isomorphism $\mathfrak{t}_1/W_1 \simeq \mathfrak{t}_2/W_2$. We can therefore transfer regular semisimple stable conjugacy classes from $\mathfrak{g}_1(F)$ to $\mathfrak{g}_2(F)$ and back.

Conjecture 6 (Nonstandard fundamental lemma). *Let $\gamma_1 \in \mathfrak{g}_1(F)$ and $\gamma_2 \in \mathfrak{g}_2(F)$ be regular semisimple elements having the same characteristic polynomial. Then we have*

$$\mathbf{SO}_{\gamma_1}(1_{\mathfrak{g}_1(\mathcal{O}_F)}) = \mathbf{SO}_{\gamma_2}(1_{\mathfrak{g}_2(\mathcal{O}_F)}). \quad (17)$$

3.5. The long march. Let us remember the long march to the conquest of the transfer conjecture and the fundamental lemma.

The theory of endoscopy for real groups is almost entirely due to Shelstad. She proved, in particular, the transfer conjecture for real groups. The fundamental lemma does not make sense for real groups.

Particular cases of the fundamental lemma were proved in low rank case by Labesse-Langlands for $\mathrm{SL}(2)$ [38], Kottwitz for $\mathrm{SL}(3)$ [30], Rogawski for $\mathrm{U}(3)$ [58], Hales, Schroder and Weissauer for $\mathrm{Sp}(4)$. The first case of twisted fundamental lemma was proved by Saito, Shintani and Langlands in the case of base change for $\mathrm{GL}(2)$. The conjecture 4 in the case of stable base change was proved by Kottwitz [33] for unit and then 5 by Clozel and Labesse independently for Hecke algebra. Kazhdan [27], and Waldspurger [66] proved 4 for $\mathrm{SL}(n)$. More recently, Laumon and myself proved the case $\mathrm{U}(n)$ [50] in equal characteristic.

The following result is to a large extent a collective work.

Theorem 7. *The conjectures 3, 4, 5 and 6 are true for p -adic fields.*

In the landmark paper [67], Waldspurger proved that the fundamental lemma implies the transfer conjectures. Due to his and Hales' works, the case of Lie group follows from the case of Lie algebra. Waldspurger also proved that the twisted fundamental lemma follows from the combination of the fundamental lemma with his nonstandard variant [68]. In [19], Hales proved that if we know the fundamental lemma for the unit for almost all places, we know it for the entire Hecke algebra for all places. In particular, if we know the fundamental lemma for the unit element at all but finitely many places, we also know it at the remaining places. More details on Hales' argument can be found in [53].

The problem is reduced to the fundamental lemma for Lie algebra. Following Waldspurger and, independently, Cluckers, Hales and Loeser, it is enough to prove the fundamental lemma for a local field in characteristic p , see [69] and [12].

For local fields of characteristic p , the approach using algebraic geometry was eventually successful. This approach originated in the work of Kazhdan and Lusztig who introduced the affine Springer fiber, cf. [28]. In [18], Goresky,

Kottwitz and MacPherson gave an interpretation of the fundamental lemma in terms of the cohomology of the affine Springer. They also introduced the use of the equivariant cohomology and proved the fundamental lemma for unramified elements assuming the purity of cohomology of affine Springer fiber. Later in [49], Laumon proved the fundamental lemma for general element in the Lie algebra of unitary group also by using the equivariant cohomology and admitting the same purity assumption. The conjecture of purity of cohomology of affine Springer fiber is still unproved.

The Hitchin fibration was introduced in this context in [54]. Laumon and I used this approach, combined with [49], to prove the fundamental lemma for unitary group in [50]. The equivariant cohomology is no longer used for effective calculation of cohomology but to prove a qualitative property of the support of simple perverse sheaves occurring in the cohomology of Hitchin fibration. Later, I realized that the equivariant cohomology does not work in general simply due to the lack of toric action. The general case was proved in [56] with essentially the same strategy as in [50] but with a major difference. Since the equivariant cohomology does not provide a general argument for the determination of the support of simple perverse sheaves occurring in the cohomology of Hitchin fibration, an entirely different argument was needed. This new argument is a blend of an observation of Goresky and MacPherson on perverse sheaves and Poincaré duality with some particular geometric properties of algebraic integrable systems *cf.* [57].

4. Affine Springer Fibers and the Hitchin Fibration

In this section, we will describe the geometric approach to the fundamental lemma.

4.1. Affine Springer fibers. Let $k = \mathbb{F}_q$ be a finite field with q elements. Let G be a reductive group over k and \mathfrak{g} its Lie algebra. Let $F = k((\pi))$ and $\mathcal{O}_F = k[[\pi]]$. Let $\gamma \in \mathfrak{g}(F)$ be a regular semisimple element. According to Kazhdan and Lusztig [28], there exists a k -scheme \mathcal{M}_γ whose set of k points is

$$\mathcal{M}_\gamma(k) = \{g \in G(F)/G(\mathcal{O}_F) \mid \text{ad}(g)^{-1}(\gamma) \in \mathfrak{g}(\mathcal{O}_F)\}.$$

They proved that the affine Springer fiber \mathcal{M}_γ is finite dimensional and locally of finite type.

The centralizer $I_\gamma(F)$ acts on $\mathcal{M}_\gamma(k)$. The group $I_\gamma(F)$ can be given a structure of infinite dimensional group $\tilde{\mathcal{P}}_\gamma$ over k , acting on \mathcal{M}_γ . There exists a unique quotient \mathcal{P}_γ of $\tilde{\mathcal{P}}_\gamma$ such that the above action factors through \mathcal{P}_γ and there exists an open subvariety of \mathcal{M}_γ over which \mathcal{P}_γ acts simply transitively.

Here is a simple but important example. Let $G = \mathrm{SL}_2$ and let γ be the diagonal matrix

$$\gamma = \begin{pmatrix} \pi & 0 \\ 0 & -\pi \end{pmatrix}.$$

In this case \mathcal{M}_γ is an infinite chain of projective lines with the point ∞ in each copy being identified with the point 0 of the next one. The group \mathcal{P}_γ is $\mathbb{G}_m \times \mathbb{Z}$ with \mathbb{G}_m acting on each copy of \mathbb{P}^1 by rescaling and the generator of \mathbb{Z} acting by translation from each copy to the next one. The dense open orbit is obtained by removing from \mathcal{M}_γ its double points.

We have a cohomological interpretation for stable κ -orbital integrals. Let us fix an isomorphism $\bar{\mathbb{Q}}_\ell \simeq \mathbb{C}$ so that κ can be seen as taking values in $\bar{\mathbb{Q}}_\ell$. Then we have the formula

$$\mathbf{O}_\gamma^\kappa(1_{\mathfrak{g}(\mathcal{O}_F)}) = \#\mathcal{P}_\gamma^0(k)^{-1} \mathrm{tr}(\mathrm{Fr}_q, \mathrm{H}^*(\mathcal{M}_\gamma \otimes_k \bar{k}, \bar{\mathbb{Q}}_\ell)_\kappa)$$

where Fr_q denotes the action of the geometric Frobenius on the ℓ -adic cohomology of the affine Springer fiber. In the case where the component group $\pi_0(\mathcal{P}_\gamma)$ is finite, $\mathrm{H}^*(\mathcal{M}_\gamma, \bar{\mathbb{Q}}_\ell)_\kappa$ is the biggest direct summand of $\mathrm{H}^*(\mathcal{M}_\gamma, \bar{\mathbb{Q}}_\ell)$ on which \mathcal{P}_γ acts through the character κ . By taking $\kappa = 1$, we obtained a cohomological interpretation of the stable orbital integral

$$\mathbf{SO}_\gamma(1_{\mathfrak{g}(\mathcal{O}_F)}) = \#\mathcal{P}_\gamma^0(k)^{-1} \mathrm{tr}(\mathrm{Fr}_q, \mathrm{H}^*(\mathcal{M}_\gamma, \bar{\mathbb{Q}}_\ell)_{st})$$

where the index st means the direct summand where \mathcal{P}_γ acts trivially. When $\pi_0(\mathcal{P}_\gamma)$ is infinite, the definition of $\mathrm{H}^*(\mathcal{M}_\gamma, \bar{\mathbb{Q}}_\ell)_{st}$ and $\mathrm{H}^*(\mathcal{M}_\gamma, \bar{\mathbb{Q}}_\ell)_\kappa$ is a little bit more complicated.

Cohomological interpretation of the fundamental lemma follows from the above cohomological interpretation of stable and κ -orbital integrals. In general, it does not seem possible to prove the cohomological fundamental lemma by a direct method because the ℓ -adic cohomology of the affine Springer fiber is as complicated as the orbital integrals. Nevertheless, in the case of unramified conjugacy classes, by using a large torus action of the affine Springer fiber and the Borel-Atiyah-Segal localization theorem for equivariant cohomology, Goresky, Kottwitz and MacPherson proved a formula for the ℓ -adic cohomology of unramified affine fibers in assuming the purity conjecture. It should be noticed however that there may be no torus action on the affine Springer fibers associated to most ramified conjugacy classes.

4.2. The Hitchin fibration. The Hitchin fibration appears in a quite remote area from the trace formula and the theory of endoscopy. It is fortunate that the geometry of the Hitchin fibration and the arithmetic of endoscopy happen to be just different smiling faces of Bayon Avalokiteshvara.

In [25], Hitchin constructed a large family of algebraic integrable systems. Let X be a smooth projective complex curve and Bun_G^{st} the moduli space of stable G -principal bundles on X . The cotangent bundle $T^*\mathrm{Bun}_G^{st}$ is naturally

a symplectic variety so that its algebra of analytic functions is equipped with a Poisson bracket $\{f, g\}$. It has dimension $2d$ where d is the dimension of Bun_G . Hitchin proves the existence of d Poisson commuting algebraic functions on $T^*\text{Bun}_G$ that are algebraically independent

$$f = (f_1, \dots, f_d) : T^*\text{Bun}_G^{st} \rightarrow \mathbb{C}^d. \quad (18)$$

The Hamiltonian vector fields associated to f_1, \dots, f_d form d commuting vector fields along the fiber of f . Hitchin proved that generic fibers of f are open subsets of abelian varieties and Hamiltonian vector fields are linear.

To recall the construction of Hitchin, it is best to relax the stability condition and consider the algebraic stack Bun_G of all principal G -bundles instead of its open substack Bun_G^{st} of stable bundles. Following Hitchin, a Higgs bundle is a pair (E, ϕ) , where $E \in \text{Bun}_G$ is a principal G -bundle over X and ϕ is a global section of $\text{ad}(E) \otimes K$, K being the canonical bundle of X . Over the stable locus, the moduli space \mathcal{M} of all Higgs bundles coincide with $T^*\text{Bun}_G^{st}$ by Serre's duality.

According to Chevalley and Kostant, the algebra $\mathbb{C}[\mathfrak{g}]^G$ of adjoint invariant function is a polynomial algebra generated by homogeneous functions a_1, \dots, a_r of degree $e_1 + 1, \dots, e_r + 1$ where e_1, \dots, e_r are the exponents of the root system. If (E, ϕ) is a Higgs bundle then $a_i(\phi)$ is well defined as a global section of $K^{\otimes(e_i+1)}$. This defines a morphism $f : \mathcal{M} \rightarrow \mathcal{A}$ where \mathcal{A} is the affine space

$$\mathcal{A} = \bigoplus_{i=1}^r \text{H}^0(X, K^{\otimes(e_i+1)}).$$

whose dimension equals somewhat miraculously the dimension d of $\dim(\text{Bun}_G)$. This construction applies also to a more general situation where K is replaced by an arbitrary line bundle, but of course the symplectic form as well as the equality of dimension are lost. It is not difficult to extend Hitchin's argument to prove that, after passing from the coarse moduli space to the moduli stack, the generic fiber of f is isomorphic to an extension of a finite group by an abelian variety. More canonically, the generic fiber of f is a principal homogeneous space under the action of the extension of a finite group by an abelian variety. On the infinitesimal level, this action is nothing but the action of the Hamiltonian vector fields along the fibers of f . We observe that Hamiltonian vector fields act also on singular fibers of f , and we would like to understand the the geometry of those fibers by this action.

In [54], we constructed a smooth Picard stack $g : \mathcal{P} \rightarrow \mathcal{A}$ that acts on $f : \mathcal{M} \rightarrow \mathcal{A}$. In particular, for every $a \in \mathcal{A}$, \mathcal{P}_a acts on \mathcal{M}_a in integrating the infinitesimal action of the Hamiltonian vector fields. For generic parameters a , the action of \mathcal{P}_a on \mathcal{M}_a is simply transitive but for degenerate parameters a , it is not. We observe the important product formula

$$[\mathcal{M}_a/\mathcal{P}_a] = \prod_{v \in X} [\mathcal{M}_{a,v}/\mathcal{P}_{a,v}] \quad (19)$$

that expresses the quotient $[\mathcal{M}_a/\mathcal{P}_a]$ as an algebraic stack as the product of affine Springer fibers $\mathcal{M}_{a,v}$ by its group of symmetry $\mathcal{P}_{a,v}$. For almost all v , $\mathcal{M}_{a,v}$ is a discrete set acted on simply transitively by $\mathcal{P}_{a,v}$.

In order to get an insight of the product formula, it is best to switch the base field from the field of complex numbers to a finite field k . In this case, it is instructive to count the number of k -points on the Hitchin fiber \mathcal{M}_a as well as on the quotients $[\mathcal{M}_a/\mathcal{P}_a]$. In order to get actual numbers, we assume that the component group $\pi_0(\mathcal{P}_a)$ is finite. This is the case for a in an open subset \mathcal{A}^{ell} of \mathcal{A} , called the elliptic part, to which we will restrict ourselves from now on.

More details about the following discussion can be found in [54, 55]. For $a \in \mathcal{A}^{ell}(k)$, the fiber \mathcal{M}_a is a proper Deligne-Mumford stack and the number of its k -points can be expressed as a sum

$$|\mathcal{M}_a(k)| = \sum_{\gamma \in \mathfrak{g}(F)/\sim, \chi(f)=a} \mathbf{O}_\gamma(1_D) \tag{20}$$

over rational conjugacy classes $\gamma \in \mathfrak{g}(F)/\sim$, F denoting the function field of X within the stable conjugacy class defined by a , of global orbital integral (11) of certain adelic function 1_D , whose local expression $1_D = \prod_{v \in |X|} 1_{D_v}$ is given by the choice of a global section of the line bundle $K = \mathcal{O}_X(D)$. The number of k -points on the quotient $[\mathcal{M}_a/\mathcal{P}_a]$ can be expressed as a product of stable orbital integrals

$$|[\mathcal{M}_a/\mathcal{P}_a](k)| = \prod_{v \in |X|} \mathbf{SO}_a(1_{K_v}) \tag{21}$$

We will now look for an expression of the sum of global orbital integrals (20) in terms of stable orbital (21) plus correcting terms as in the stabilization of the trace formula. In our geometric terms, this expression becomes

$$|\mathcal{M}_a(k)| = |\mathcal{P}_a^0(k)| \sum_{\kappa} \mathbf{O}_{\gamma_a}^\kappa(1_D) \tag{22}$$

where $\mathbf{O}_{\gamma_a}^\kappa$ are κ -orbital integrals attached to the Kostant conjugacy class γ_a in the stable class a with respect to a Frobenius invariant character $\kappa : \pi_0(\mathcal{P}_a) \rightarrow \mathbb{Q}_\ell^\times$. The component group $\pi_0(\mathcal{P}_a)$ or the smile of Avalokiteshvara is the origin of endoscopic pain.

The cohomological interpretation of the formula (22) is the decomposition into direct sum of the cohomology of \mathcal{M}_a with respect to the action of $\pi_0(\mathcal{P}_a)$

$$\mathbf{H}^*(\mathcal{M}_a \otimes_k \bar{k}, \mathbb{Q}_\ell) = \bigoplus_{\kappa: \pi_0(\mathcal{P}_a) \rightarrow \mathbb{Q}_\ell^\times} \mathbf{H}^*(\mathcal{M}_a \otimes_k \bar{k}, \mathbb{Q}_\ell)_\kappa. \tag{23}$$

It is not obvious to understand how this decomposition depends on a since the component group $\pi_0(\mathcal{P}_a)$ also depends on a . According to a theorem of Grothendieck, the component groups $\pi_0(\mathcal{P}_a)$ for varying a can be interpolated

as fiber of a sheaf of abelian groups $\pi_0(\mathcal{P})$ for the étale topology of \mathcal{A} . Restricted to the elliptic part \mathcal{A}^{ell} , $\pi_0(\mathcal{P})$ is a sheaf of finite abelian groups. One of the difficulties to understand the decomposition (23) lies in the fact that $\pi_0(\mathcal{P})$ is not a constant sheaf. Nevertheless, the sheaf $\pi_0(\mathcal{P})$ acts on the perverse sheaves of cohomology

$${}^p\mathrm{H}^n(f_*\mathbb{Q}_\ell|_{\mathcal{A}})$$

and decomposes it into a direct sum canonically indexed by a finite set of semisimple conjugacy classes of the dual group \hat{G}

$${}^p\mathrm{H}^n(f_*\mathbb{Q}_\ell|_{\mathcal{A}^{ell}}) = \bigoplus_{[\kappa] \in \hat{G}/\sim} {}^p\mathrm{H}^n(f_*\mathbb{Q}_\ell|_{\mathcal{A}^{ell}}).$$

This peculiar decomposition reflects the combinatorial complexity of the stabilization of the trace formula, see [54, 55]. Among the direct summand, the main term corresponding to $\kappa = 1$ is called the stable piece. For instance, the surprising appearance of semisimple conjugacy classes of the dual group reflects the presence of the equivalence classes of endoscopic groups in the stabilization of the trace formula.

The stabilization of the trace formula as envisioned by Langlands and Kottwitz suggests that the $[\kappa]$ -part in the above decomposition should correspond to the stable part in the similar decomposition for an endoscopic group. This prediction can be realized in a clean geometric formulation after we pass to the étale scheme $\tilde{\mathcal{A}}$ over \mathcal{A} cf. [56] which depends on the choice of a point $\infty \in X$. It was constructed in such a way that over $\tilde{\mathcal{A}}$, $\pi_0(\mathcal{P})$ becomes a quotient of the constant sheaf, whose sections over any connected test scheme are cocharacters of the maximal torus T . Over $\tilde{\mathcal{A}}^{ell}$, we obtain a finer decomposition

$${}^p\mathrm{H}^n(f_*\mathbb{Q}_\ell|_{\tilde{\mathcal{A}}^{ell}}) = \bigoplus_{\kappa \in \hat{T}} {}^p\mathrm{H}^n(f_*\mathbb{Q}_\ell|_{\tilde{\mathcal{A}}^{ell}})_\kappa$$

indexed by a finite subset of the maximal torus \hat{T} in \hat{G} .

Let $\kappa \in \hat{T}$ correspond to a nontrivial piece in the above decomposition. The κ -component of the above direct sum is supported by the locus $\tilde{\mathcal{A}}_\kappa^{ell}$ in $\tilde{\mathcal{A}}^{ell}$ given by the elements $\tilde{a} \in \tilde{\mathcal{A}}^{ell}$ such that $\kappa : \mathbf{X}_*(T) \rightarrow \mathbb{Q}_\ell^\times$ factors through $\pi_0(\mathcal{P}_{\tilde{a}})$. This locus is not connected; its connected components are classified by homomorphism $\rho : \pi_1(X, \infty) \rightarrow \pi_0(\hat{G}_\kappa)$. Such a homomorphism defines a reductive group scheme H over X whose dual group is \hat{H}_ρ by outer twisting. It can be checked that the connected component of $\tilde{\mathcal{A}}_\kappa^{ell}$ corresponding to ρ is just the Hitchin base \mathcal{A}_{H_ρ} for the reductive group scheme H_ρ . Let $\iota_{\kappa, \rho} : \tilde{\mathcal{A}}_{H_\rho} \rightarrow \tilde{\mathcal{A}}$ denote this closed immersion.

Theorem 8. *Let G be a split semisimple group. There exists an isomorphism*

$$\bigoplus_n {}^p\mathrm{H}^n(f_*\mathbb{Q}_\ell|_{\tilde{\mathcal{A}}^{ell}})_\kappa[2r](r) \sim \bigoplus_\rho (\iota_{\kappa, \rho})_* \bigoplus_n {}^p\mathrm{H}^n(f_{H_\rho, *}\mathbb{Q}_\ell|_{\tilde{\mathcal{A}}_{H_\rho}^{ell}})_{st}$$

where ρ are homomorphisms $\rho : \pi_1(X, \infty) \rightarrow \pi_0(\hat{G}_\kappa)$ and where r is some multiple of $\deg(K)$.

Here we stated our theorem in the case of split group, but it is valid for quasi-split group as well. In fact, the theorem was first proved for quasi-split unitary group by Laumon and myself in [50] before the general case was proved in [56]. To be more precise, the above theorem is proved under the assumption that the characteristic of the residue field is at least twice the Coxeter number of G .

The fundamental lemma for Lie algebra in equal characteristic case follows from the above theorem by a local-global argument. The unequal characteristic case follows from the equal characteristic case by theorem of Waldspurger [69] and Cluckers, Hales, Loeser [12]. Waldspurger assumes that p does not divide the order of the Weyl group and Cluckers, Hales, Loeser needs a much stronger lower bound on p . In number field case, these assumptions do not matter as Hales proved that the validity of the fundamental lemma at almost all places implies its validity at the remaining places. Currently, the fundamental lemma for local fields of positive characteristic small with respect to G , is not known.

4.3. Support theorem. The main ingredient in the proof of theorem 8 is the determination of the support of simple perverse sheaves that appear as constituent of perverse cohomology of $f_*\mathbb{Q}_\ell$.

Let C be a pure ℓ -adic complex over a scheme S of finite type over a finite field k . Its perverse cohomology ${}^p\mathrm{H}^n(C)$ are then perverse sheaves and geometrically semisimple according to a theorem of Beilinson, Bernstein, Deligne and Gabber *cf.* [5]. According to Goresky and MacPherson, geometrically simple perverse sheaves are of the following form: let Z be a closed irreducible subscheme of $S \otimes_k \bar{k}$ with $i : Z \rightarrow S \otimes_k \bar{k}$ denoting the closed immersion, let U be a smooth open subscheme of Z with $j : U \rightarrow Z$ denoting the open immersion, let \mathcal{K} be a local system on U , then $K = i_*j_{!*}\mathcal{K}[\dim(Z)]$ is a simple perverse sheaf, $j_{!*}$ being the functor of intermediate extension, and every simple perverse sheaf on $S \otimes_k \bar{k}$ is of this form. In particular, the support $Z = \mathrm{supp}(K)$ of a simple perverse sheaf is well defined. For a pure ℓ -adic complex C over a scheme S , we can ask the question what is the set of supports of simple perverse sheaves occurring as direct factors of the perverse sheaves of cohomology ${}^p\mathrm{H}^n(C)$.

The main topological ingredient in the proof of theorem 8 is the determination of this set of supports. We state only the result in characteristic zero. In characteristic p , we prove a weaker result, more complicated to state but enough for the purposes of the fundamental lemma.

Theorem 9. *Assume the base field k is the field of complex numbers. Then for any simple perverse sheaf K direct factor of ${}^p\mathrm{H}^n(f_*\mathbb{Q}_\ell|_{\tilde{\mathcal{A}}^{\mathrm{ell}}})_{st}$, the support of K is $\tilde{\mathcal{A}}^{\mathrm{ell}}$. Similarly, if K is a direct factor of ${}^p\mathrm{H}^n(f_*\mathbb{Q}_\ell|_{\tilde{\mathcal{A}}^{\mathrm{ell}}})_\kappa$, then the support of K is of the form $\iota_\rho(\tilde{\mathcal{A}}_{H_\rho})$ for certain homomorphism $\rho : \pi_1(X, \infty) \rightarrow \pi_0(\hat{G}_\kappa)$.*

If we know two perverse sheaves having simple constituents of the same support, in order to construct an isomorphism between them, it is enough to construct an isomorphism over an open subset of the support. Over a small enough open subscheme, the isomorphism can be constructed directly.

Let us explain the proof of the nonstandard fundamental lemma conjectured by Waldspurger. Let G_1, G_2 be semisimple groups with isogeneous root systems. Their Hitchin moduli spaces $\mathcal{M}_1, \mathcal{M}_2$ map to the same base $\mathcal{A} = \mathcal{A}_1 = \mathcal{A}_2$. Let restrict to the elliptic locus and put $\mathcal{A} = \mathcal{A}^{ell}$. In order to prove $(f_{1*}\mathbb{Q}_\ell)_{st} \sim (f_{2*}\mathbb{Q}_\ell)_{st}$, it is enough to prove that they are isomorphic over an open subscheme of \mathcal{A} , as we know every simple perverse sheaf occurring in either one of these two complexes have support \mathcal{A}^{ell} . Over an open subscheme of \mathcal{A}^{ell} , \mathcal{M}_1 is acted on simply transitively by extension of a finite group by an abelian scheme and so is \mathcal{M}_2 . The nonstandard fundamental lemma follows now from the fact that the above two abelian schemes are isogeneous and isogeneous abelian varieties have the same cohomology.

4.4. Weighted fundamental lemma. According to Waldspurger, the twisted fundamental lemma follows from the usual fundamental lemma and its nonstandard variant. Combining with his theorem that the fundamental lemma implies the transfer, the local results needed to stabilize the elliptic part of the trace formula and the twisted trace formula.

The classification of automorphic forms on quasisplit classical group requires the full power of the stabilization of the entire trace formula. For this purpose, Arthur needs more the twisted weighted fundamental lemma. This conjecture is an identity between twisted weighted orbital integrals.

The weighted fundamental lemma is now a theorem due to Chaudouard and Laumon *cf.* [9]. In the particular case of $\mathrm{Sp}(4)$, it was previously proved by Whitehouse *cf.* [72]. They introduced a condition of χ -stability in Higgs bundles such that the restriction of the Hitchin map $f : \mathcal{M} \rightarrow \mathcal{A}$ to the open subset \mathcal{A}^\heartsuit of stable conjugacy classes that are generically regular semisimple and to moduli stack of χ -stable bundles $\mathcal{M}_{\chi-st}^\heartsuit$

$$f_{\chi-st}^\heartsuit : \mathcal{M}_{\chi-st}^\heartsuit \rightarrow \mathcal{A}^\heartsuit$$

is a proper morphism. This is an extension of the proper morphism $f^{ell} : \mathcal{M}^{ell} \rightarrow \mathcal{A}^{ell}$ that depends on a stability parameter χ . Chaudouard and Laumon extended the support theorem from f^{ell} to $f_{\chi-st}^\heartsuit$. They also showed that the number of points on a hyperbolic fiber of \mathcal{A}^\heartsuit can be expressed in terms of weighted orbital integrals. The weighted fundamental lemma follows. It is quite remarkable that the moduli space depends on the stability parameter χ , though the number of points and the ℓ -adic complex of cohomology don't.

Finally, Waldspurger showed that the twisted weighted fundamental lemma follows from the weighted fundamental lemma and its nonstandard variant. He also showed that, if these statements are known for a local field of characteristic

p , they are also known for a p -adic local field with the same residue field, provided the residual characteristic does not divide the order of the Weyl group.

5. Functoriality Beyond Endoscopy

The unstability of the trace formula has been instrumental in establishing the first cases of the functoriality conjecture. The stable trace formula now fully established by Arthur should be the main tool in our quest for more general functoriality.

In [43], Langlands proposed new insights for the general case of functoriality principle. He observed that we are primarily concerned with the question how to distinguish automorphic representations π of G whose hypothetical parametrization $\sigma : L_F \rightarrow {}^L G$ has image contained in a smaller subgroup. Assume π of Ramanujan type (or tempered), the Zariski closure of the image of σ is not far from being determined by the order of the pole at 1 of the L -functions $L(s, \rho, \pi)$ for all representations ρ of ${}^L G$. Though we are not in position to work directly with these L -functions individually, the stable trace formula can be effective in dealing with the sum of L -functions attached to all automorphic representations π or the sum of their logarithmic derivative. Nontempered representations, especially the trivial representation, represent an obstacle to this strategy as they contribute to this sum the dominant term. The subsequent article [15], directly inspired from [43], might have proposed a method to subtract the dominant contribution. Other works [65, 48, 16], more or less inspired from [43], are the first encouraging steps on this new path that might lead us to the general case of functoriality.

Acknowledgment

I would like to express my deep gratitude to Laumon and Kottwitz who have been helping and encouraging me in the long march in pursuit of the lemma. I would like to thank Langlands for his comments on this report and to Mœglin for an useful conversation on its content. I would like to thank Dottie Phares for helping me with english.

References

- [1] Arthur, J., *A stable trace formula. III. Proof of the main theorems*. Ann. of Math. (2) 158 (2003), no. 3, 769–873.
- [2] Arthur, J., *An introduction to the trace formula*. in Harmonic analysis, the trace formula, and Shimura varieties, 1–263, Clay Math. Proc., 4, Amer. Math. Soc., Providence, RI, 2005.
- [3] Arthur, J., Clozel, L., *Simple algebras, base change, and the advanced theory of the trace formula*. Annals of Mathematics Studies, 120. Princeton University Press, Princeton, NJ, 1989.

-
- [4] Badulescu, I, *Global Jacquet-Langlands correspondence, multiplicity one and classification of automorphic representations*. With an appendix by Neven Grbac. Invent. Math. 172 (2008), no. 2, 383–438.
 - [5] Beilinson A., Bernstein J., Deligne P.: Faisceaux pervers. *Astérisque* 100 (1982).
 - [6] Borel, A., Jacquet, H., *Automorphic forms and automorphic representations*, in Proc. of Symp. in Pure Math. 33 ed. by A. Borel and W. Casselman, Amer. Math. Soc., 1977.
 - [7] Breuil, C.; Conrad, B.; Diamond, F.; Taylor, R., *On the modularity of elliptic curves over \mathbf{Q} : wild 3-adic exercises*. J. Amer. Math. Soc. 14 (2001), no. 4, 843–939
 - [8] Cartier, P. Representation of p -adic groups: A survey, in Proc. of Symp. in Pure Math. 33 ed. by A. Borel and W. Casselman, Amer. Math. Soc., 1977.
 - [9] Chaudouard, P.-H., Laumon, G., *Le lemme fondamental pondéré*, preprint.
 - [10] Clozel, L. *Représentations galoisiennes associées aux représentations automorphes autoduales de $GL(n)$* , Publ. IHES 73 (1991), 97145.
 - [11] Clozel, L., Harris, M., Labesse, J.-P. *Construction of automorphic Galois representations*. Chevaleret’s Book Project.
 - [12] Cluckers, R., Hales, T., Loeser, F, *Transfer Principle for the Fundamental Lemma*, Chevaleret’s Book Project.
 - [13] Dirichlet, G., *Démonstration d’un théorème sur la progression arithmétique*, 1834, *Werke* Bd. I, p.307.
 - [14] Drinfeld, V. *Langlands’ conjecture for $GL(2)$ over functional fields*. Proceedings of the International Congress of Mathematicians (Helsinki, 1978), pp. 565–574, Acad. Sci. Fennica, Helsinki, 1980.
 - [15] Frenkel, E., Langlands, R., Ngô, B.C. *Formule des traces et functorialité: le début d’un programme*, preprint.
 - [16] Frenkel, E., Ngô, B.C. *Geometrization of trace formulas*, preprint.
 - [17] Godement, R., Jacquet, H., *Zeta functions of simple algebras*. Lecture Notes in Mathematics, Vol. 260. Springer-Verlag, Berlin-New York, 1972.
 - [18] Goresky M., Kottwitz R., MacPherson R.: *Homology of affine Springer fiber in the unramified case*. Duke Math. J. 121 (2004) 509–561.
 - [19] Hales, T., *On the fundamental lemma for standard endoscopy: reduction to unit elements*. Canad. J. Math. 47 (1995), no. 5, 974–994.
 - [20] Harris, M., Taylor, R., *The geometry and cohomology of some simple Shimura varieties*. With an appendix by Vladimir G. Berkovich. Annals of Mathematics Studies, 151. Princeton University Press, Princeton, NJ, 2001.
 - [21] M.Harris, N.Shepherd-Barron and R.Taylor *A family of Calabi-Yau varieties and potential automorphy*. Annals of Math. 171 (2010), 779-813.
 - [22] Henniart, G., *Une preuve simple des conjectures de Langlands pour $GL(n)$ sur un corps p -adique*. Invent. Math. 139 (2000), no. 2, 439–455.
 - [23] Henniart, G. *On the local Langlands and Jacquet-Langlands correspondences*. International Congress of Mathematicians. Vol. II, 1171–1182, Eur. Math. Soc., Zurich, 2006.

- [24] Hiraga, K., Saito, H., *On L -packets for inner forms of $SL(n)$* , preprint.
- [25] Hitchin N.: Stable bundles and integrable systems. *Duke Math. J.* 54 (1987) 91–114.
- [26] Kim, H., Shahidi, F. *Symmetric cube L -functions for GL_2 are entire*. *Ann. of Math.* (2) 150 (1999), no. 2, 645–662.
- [27] Kazhdan, D., *On lifting in Lie group representations, II*, 209–249, *Lecture Notes in Math.*, 1041, Springer, Berlin, 1984.
- [28] Kazhdan, D. Lusztig, G. *Fixed point varieties on affine flag manifolds*. *Israel J. Math.* 62 (1988), no. 2, 129–168.
- [29] Kostant, B., *Lie group representations on polynomial rings*. *Amer. J. Math.* 85 (1963) 327–404.
- [30] Kottwitz, R., *Unstable orbital integrals on $SL(3)$* . *Duke Math. J.* 48 (1981), no. 3, 649–664
- [31] Kottwitz, R., *Stable trace formula: cuspidal tempered terms*. *Duke Math. J.* 51 (1984), no. 3, 611–650.
- [32] Kottwitz, R. *Stable trace formula: singular elliptic terms*. *Math. Ann.* 275 (1986), no. 3, 365–399.
- [33] Kottwitz, R. *Base change for unit elements of Hecke algebras*. *Compositio Math.* 60 (1986), no. 2, 237–250.
- [34] Kottwitz, R., *Shimura varieties and λ -adic representations*. in *Automorphic forms, Shimura varieties, and L -functions, Vol. I* (Ann Arbor, MI, 1988), 161–209, *Perspect. Math.*, 10, Academic Press, Boston, MA, 1990.
- [35] Kottwitz, R., *Points on some Shimura varieties over finite fields*. *J. Amer. Math. Soc.* 5 (1992), no. 2, 373–444.
- [36] Kottwitz, R., *Transfer factors for Lie algebras*. *Represent. Theory* 3 (1999), 127–138
- [37] Labesse, J.-P. *Changement de base CM et séries discrètes*. Chevaleret’s Book Project.
- [38] Labesse, J.-P., Langlands, R. *L -indistinguishability for $SL(2)$* , *Can. J. Math.* 31 (1979), p. 726–785.
- [39] Langlands, R., *Problems in the Theory of Automorphic Forms*, *Lecture Notes in Mathematics*, Vol. 170. Springer-Verlag, Berlin-New York, 1970.
- [40] Langlands, R., Letter to Lang (1970) and Langlands’ comments on this letter, available at <http://publications.ias.edu/rpl>.
- [41] Langlands, R. *Base change for $GL(2)$* . *Annals of Mathematics Studies*, 96. Princeton University Press, Princeton, N.J., 1980.
- [42] Langlands, R., *Les débuts d’une formule des traces stables*. [Mathematical Publications of the University of Paris VII], 13. Université de Paris VII, U.E.R. de Mathématiques, Paris, 1983. v+188 pp.
- [43] Langlands R. *Beyond endoscopy*. available at <http://publications.ias.edu/rpl>.
- [44] Langlands, R., *A review of Haruzo Hida’s p -adic automorphic forms on Shimura varieties*. *Bull. of the A.M.S.* 44 (2007) no. 2, 291–308.

- [45] Langlands, R., Shelstad, D., *On the definition of transfer factors* Math. Ann. 278 (1987), no. 1-4, 219–271.
- [46] Lafforgue, L. *Chtoucas de Drinfeld et correspondance de Langlands*. Invent. Math. 147 (2002), no. 1, 1–241.
- [47] Lafforgue, L. *Chtoucas de Drinfeld, formule des traces d’Arthur-Selberg et correspondance de Langlands*. Proceedings of the International Congress of Mathematicians, Vol. I (Beijing, 2002), 383–400, Higher Ed. Press, Beijing, 2002.
- [48] Lafforgue, L. *Construire des noyaux de la fonctorialité*, preprint.
- [49] *Sur le lemme fondamental pour les groupes unitaires*, preprint.
- [50] Laumon, G., Ngô, B.-C., *Le lemme fondamental pour les groupes unitaires*. Ann. of Math. (2) 168 (2008), no. 2, 477–573.
- [51] Laumon, G., Rapoport, M., Stuhler U. *\mathcal{D} -elliptic sheaves and the Langlands correspondence*. Invent. Math. 113 (1993), no. 2, 217–338.
- [52] Mœglin, C., *Classification et changement de base pour les séries discrètes des groupes unitaires p -adiques*. Pacific J. Math. 233 (2007), no. 1, 159–204.
- [53] Morel, S. *On the cohomology of certain noncompact Shimura varieties*. With an appendix by Robert Kottwitz. Annals of Mathematics Studies, 173. Princeton University Press, Princeton, NJ, 2010.
- [54] Ngô, B.C. *Fibration de Hitchin et endoscopie*. Inv. Math. 164 (2006) 399–453.
- [55] Ngô, B.C. *Fibration de Hitchin et structure endoscopique de la formule des traces*. International Congress of Mathematicians. Vol. II, 1213–1225, Eur. Math. Soc., Zurich, 2006.
- [56] Ngô, B.C. *Le lemme fondamental pour les algèbres de Lie*, to appear in Publ. Math. de l’I.H.É.S.
- [57] Ngô, B.C. *Decomposition theorem and abelian fibration*, Chevaleret’s book project.
- [58] Rogawski, J. *Automorphic Representations of Unitary Groups in Three Variables*. Annals of Math. Studies 123 (1990).
- [59] Shelstad, D., *L -Indistinguishability for Real Groups*. Math. Annalen 259 (1982), 385–430.
- [60] Shin, S. *Galois representations arising from some compact Shimura varieties*. to appear in Ann. of Math.
- [61] Springer, A. *Reductive groups*, in Proc. of Symp. in Pure Math. 33 ed. by A. Borel and W. Casselman, Amer. Math. Soc., 1977.
- [62] Tamagawa, T., *On ζ -functions of a division algebra*, Ann. of Math. (2) 77 (1963) 387–405.
- [63] Taylor, R.; Wiles, A., *Ring-theoretic properties of certain Hecke algebras*. Ann. of Math. (2) 141 (1995), no. 3, 553–572.
- [64] Taylor, R., *On icosahedral Artin representations. II*. Amer. J. Math. 125 (2003), no. 3, 549–566.
- [65] Venkatesh, A., *“Beyond endoscopy” and special forms on $GL(2)$* . J. Reine Angew. Math. 577 (2004), 23–80.

-
- [66] Waldspurger, J.-L. *Sur les intégrales orbitales tordues pour les groupes linéaires: un lemme fondamental*. *Canad. J. Math.* 43 (1991), no. 4, 852–896.
- [67] Waldspurger, J.-L. *Le lemme fondamental implique le transfert*. *Compositio Math.* 105 (1997), no. 2, 153–236.
- [68] Waldspurger, J.-L. *L’endoscopie tordue n’est pas si tordue*. *Mem. Amer. Math. Soc.* 194 (2008), no. 908, x+261 pp.
- [69] Waldspurger, J.-L. *Endoscopie et changement de caractéristique*. *J. Inst. Math. Jussieu* 5 (2006), no. 3, 423–525.
- [70] Waldspurger, J.-L., *A propos du lemme fondamental pondéré tordu*. *Math. Ann.* 343 (2009), no. 1, 103–174.
- [71] Waldspurger, J.-L., *Endoscopie et changement de caractéristique: intégrales orbitales pondérées*. *Ann. Inst. Fourier (Grenoble)* 59 (2009), no. 5, 1753–1818
- [72] Whitehouse, D., *The twisted weighted fundamental lemma for the transfer of automorphic forms from $\mathrm{GSp}(4)$. Formes automorphes. II. Le cas du groupe $\mathrm{GSp}(4)$* . *Astrisque* No. 302 (2005), 291–436.
- [73] Wiles, A., *Modular elliptic curves and Fermat’s last theorem*. *Ann. of Math. (2)* 141 (1995), no. 3, 443–551.

On the Controllability of Nonlinear Partial Differential Equations

Jean-Michel Coron*

Abstract

A control system is a dynamical system on which one can act by using controls. A classical issue is the controllability problem: Is it possible to reach a desired target from a given starting point by using appropriate controls? We survey some methods to handle this problem when the control system is modeled by means of a nonlinear partial differential equation and when the nonlinearity plays a crucial role.

Mathematics Subject Classification (2010). Primary 93B05 93C20 93C10; Secondary 35Q30 35L50.

Keywords. Controllability, systems governed by partial differential equations, nonlinearity, Lie brackets.

1. Introduction

A control system is a dynamical system on which one can act by using suitable *controls*. Very often it is modeled by a differential equation of the following type

$$\dot{y} = f(y, u). \quad (1)$$

The variable y is the state and belongs to some space \mathcal{Y} . The variable u is the control and belongs to some space \mathcal{U} . The spaces \mathcal{Y} and \mathcal{U} can be of infinite dimension and the differential equation (1) can be a partial differential equation (PDE). There are many problems that appear when studying a control system. One of the most common ones is the *controllability* problem, which, roughly speaking, is the following one. Given two states, is it possible to steer the control system from the first one to the second one? In the framework of (1), this means that, given the state $a \in \mathcal{Y}$ and the state $b \in \mathcal{Y}$, does there exist

*Université Pierre et Marie Curie-Paris 6 and Institut universitaire de France, Laboratoire Jacques-Louis Lions, 4 place Jussieu, F-75005 France. E-mail: coron@ann.jussieu.fr

a map $u : [0, T] \rightarrow \mathcal{U}$ such that the solution of the Cauchy problem $\dot{y} = f(y, u(t))$, $y(0) = a$, satisfies $y(T) = b$? If the answer is yes, the control system is said to be *controllable*.

The purpose of this article is to survey some results on the controllability of nonlinear control systems in the case where the nonlinearity plays a crucial role. This is, for example, the case when the linearized control system around the equilibrium of interest is not controllable. This is also the case when the nonlinearity is big at infinity and one looks for global results. For convenience, we start by recalling in Section 2 some classical controllability results for control systems in finite dimension. Then, in Section 3, we turn to systems modeled by means of nonlinear partial differential equations.

2. Controllability of Finite Dimensional Control Systems

Let, for $i \in \{0, 1, \dots, m\}$, $f_i \in C^\infty(\mathbb{R}^n; \mathbb{R}^n)$. In this section, our control system is

$$\dot{y} = f(y, u) = f_0(y) + \sum_{i=1}^m u_i f_i(y), \tag{2}$$

where the state is $y = (y_1, \dots, y_n)^{\text{tr}} \in \mathbb{R}^n$ and the control is $u = (u_1, \dots, u_m)^{\text{tr}} \in \mathbb{R}^m$. We assume that $(y_e, u_e) \in \mathbb{R}^n \times \mathbb{R}^m$ is an equilibrium, i.e., $f(y_e, u_e) = 0$.

Example 1 (*Inverted pendulum on a cart*). This is the traditional example that one can find in most of the textbooks on control theory. This control system consists of a cart with an inverted pendulum on it, as represented on Figure 1. The mass of the cart is M . The pendulum rod is considered massless; its length is denoted by l . The mass of the point mass at the end of the rod is denoted by m . The force applied to the cart is the control and is denoted by F . Let $x_1 := \xi$, $x_2 := \theta$, $x_3 := \dot{\xi}$, $x_4 := \dot{\theta}$ and $u := F$. The dynamical equations governing the motion of this control system can be written in the form $\dot{y} = f(y, u)$, with $y = (y_1, y_2, y_3, y_4)^{\text{tr}}$ and

$$f(y, u) := \begin{pmatrix} y_3 \\ y_4 \\ \frac{mly_4^2 \sin y_2 - mg \sin y_2 \cos y_2}{M + m \sin^2 y_2} + \frac{u}{M + m \sin^2 y_2} \\ \frac{-mly_4^2 \sin y_2 \cos y_2 + (M + m)g \sin y_2}{(M + m \sin^2 y_2)l} - \frac{u \cos y_2}{(M + m \sin^2 y_2)l} \end{pmatrix}. \tag{3}$$

Example 2 (*Baby stroller*). Let us consider the following control system, which models a baby stroller,

$$\dot{y}_1 = u_1 \cos y_3, \dot{y}_2 = u_1 \sin y_3, \dot{y}_3 = u_2, \tag{4}$$

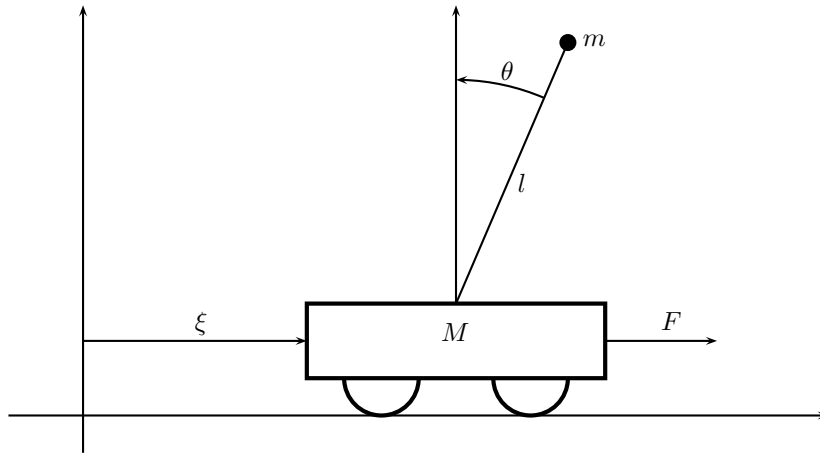

Figure 1. An inverted pendulum on a moving cart.

where the state is $(y_1, y_2, y_3)^{\text{tr}} \in \mathbb{R}^3$ and the control is $(u_1, u_2)^{\text{tr}} \in \mathbb{R}^2$. The variable y_3 is an angle which gives the orientation of the baby stroller and y_1, y_2 are the coordinates of the midpoint between the two back wheels; see Figure 2.

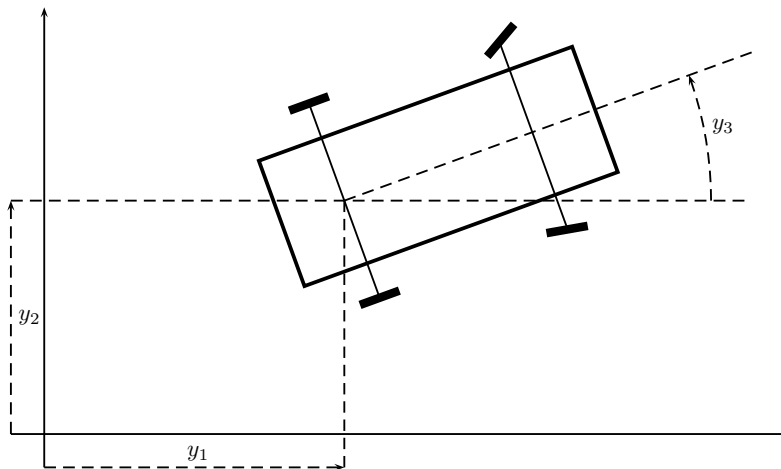

Figure 2. A baby stroller.

This control system is sometimes also called the “unicycle” or “shopping cart” control system. Note that, however, in many shops, in many shops, the four wheels of a shopping cart are castor wheels. For the baby stroller control system, only the two front wheels are castor wheels: The back wheels have a fixed direction

(relatively to the baby stroller). For the control system (4), $n = 3$, $m = 2$ and, for every $y = (y_1, y_2, y_3)^{\text{tr}} \in \mathbb{R}^3$, $f_1(y) = (\cos y_3, \sin y_3, 0)^{\text{tr}}$, $f_2(y) = (0, 0, 1)^{\text{tr}}$.

There are many possible choices for natural definitions of local controllability. The most popular one is the following one.

Definition 3 (Small-Time Local Controllability (STLC)). The control system $\dot{y} = f(y, u)$ is small-time locally controllable at (y_e, u_e) if, for every real number $\varepsilon > 0$, there exists a real number $\eta > 0$ such that, for every $y^0 \in B_\eta(y_e) := \{y \in \mathbb{R}^n; |y - y_e| < \eta\}$ and for every $y^1 \in B_\eta(y_e)$, there exists $u \in L^\infty((0, \varepsilon); \mathbb{R}^m)$ satisfying $|u(t) - u_e| \leq \varepsilon$ for almost every $t \in (0, \varepsilon)$ and such that, if $\dot{y} = f(y, u(t))$ and $y(0) = y^0$, then $y(\varepsilon) = y^1$.

The simplest control systems are linear control systems, i.e. systems such that $f(y, u) = Ay + Bu$, for some $A \in \mathcal{L}(\mathbb{R}^n; \mathbb{R}^n)$ and some $B \in \mathcal{L}(\mathbb{R}^m; \mathbb{R}^n)$, where $\mathcal{L}(\mathbb{R}^k; \mathbb{R}^l)$ denotes the set of linear maps from \mathbb{R}^k into \mathbb{R}^l . For linear systems, a necessary and sufficient condition for STLC is given by the Kalman rank condition that we recall in the next theorem.

Theorem 2.1 (Kalman’s rank condition). *The linear control system $\dot{y} = Ay + Bu$ is small-time locally controllable at $(0, 0) \in \mathbb{R}^n \times \mathbb{R}^m$ if and only if*

$$\text{Span} \{A^i Bu; u \in \mathbb{R}^m, i \in \{0, 1, \dots, n - 1\}\} = \mathbb{R}^n. \tag{5}$$

In “real life” there are very few linear control systems. But, by linearization, controllability of linear control systems is important to study the controllability of nonlinear systems. This is similar to the following classical result: Let $F \in C^1(\mathbb{R}^k, \mathbb{R}^l)$ and let $a \in \mathbb{R}^k$. Then, if $F'(a)$ is onto, F is locally onto at a , i.e., the image by F of every neighborhood of a is a neighborhood of $F(a)$. This just follows from the inverse mapping theorem. For the control system (2) and the equilibrium (y_e, u_e) , the analog of $F'(a)$ is the linearized control system at the equilibrium (y_e, u_e) , i.e. the linear control system

$$\dot{y} = \frac{\partial f}{\partial y}(y_e, u_e)y + \frac{\partial f}{\partial u}(y_e, u_e)u, \tag{6}$$

where the state is $y \in \mathbb{R}^n$ and the control is $u \in \mathbb{R}^m$. Using again the inverse mapping theorem, one has the easy but important following theorem.

Theorem 2.2 (Linear test). *If the linear control system (6) is small-time locally controllable at $(0, 0) \in \mathbb{R}^n \times \mathbb{R}^m$, then $\dot{y} = f(y, u)$ is small-time locally controllable at (y_e, u_e) .*

Example 4. We go back to the inverted pendulum on a cart, already considered in Example 1. The dynamics is $\dot{y} = f(y, u)$ where $f : \mathbb{R}^4 \times \mathbb{R}$ is defined by (3). Note that $f(0, 0) = 0$. Hence $(0, 0) \in \mathbb{R}^4 \times \mathbb{R}$ is an equilibrium of the

control system $\dot{y} = f(y, u)$. The linearized control system at this equilibrium is $\dot{y} = Ay + Bu$ with

$$A := \begin{pmatrix} 0 & 0 & 1 & 0 \\ 0 & 0 & 0 & 1 \\ 0 & -\frac{mg}{M} & 0 & 0 \\ 0 & \frac{(M+m)g}{Ml} & 0 & 0 \end{pmatrix}, B := \frac{1}{Ml} \begin{pmatrix} 0 \\ 0 \\ l \\ -1 \end{pmatrix}.$$

Simple computations show that

$$\det(B, AB, A^2B, A^3B) = -\frac{g^2}{M^4l^4} \neq 0.$$

Hence the linear control system $\dot{y} = Ay + Bu$ satisfies the Kalman rank condition (5) and therefore, by Theorem 2.1, is small-time locally controllable at $(0, 0) \in \mathbb{R}^4 \times \mathbb{R}$. By Theorem 2.2, this implies that the cart-pendulum system is small-time locally controllable at the equilibrium $(0, 0) \in \mathbb{R}^4 \times \mathbb{R}$.

Example 5. We return to the baby stroller control system (4) considered in Example 2. Note that $(0, 0) \in \mathbb{R}^3 \times \mathbb{R}^2$ is an equilibrium of this control system. The linearized control system around this equilibrium is the linear control system

$$\dot{y}_1 = u_1, \dot{y}_2 = 0, \dot{y}_3 = u_2, \quad (7)$$

where the state is $(y_1, y_2, y_3)^{\text{tr}} \in \mathbb{R}^3$ and the control is $(u_1, u_2)^{\text{tr}} \in \mathbb{R}^2$. The linear control system (7) is clearly not controllable (one cannot control y_2).

Of course, if the linearized control system around an equilibrium is not controllable, one cannot conclude anything about the small-time local controllability of the nonlinear control system at this equilibrium. This leads naturally to the question: What to do if the linearized control system is not controllable? In finite dimension the basic tool to deal with this problem is the use of (iterated) Lie brackets. Let us recall that, if $X \in C^\infty(\mathbb{R}^n; \mathbb{R}^n)$ and $Y \in C^\infty(\mathbb{R}^n; \mathbb{R}^n)$ are two smooth vector fields on \mathbb{R}^n , the Lie bracket $[X, Y]$ of X and Y is the vector field on \mathbb{R}^n defined by $[X, Y](y) := Y'(y)X(y) - X'(y)Y(y)$. Examples of iterated Lie brackets are $[X, [X, Y]]$, $[[Y, X], [X, [X, Y]]]$ etc.

Let us explain why Lie brackets are natural objects to study the local controllability problem. Let us start with the case $f_0 = 0$ (then the control system is called a driftless control system). Hence the control system is

$$\dot{y} = \sum_{i=1}^m u_i f_i(y), \quad (8)$$

where the state is $y = (y_1, \dots, y_n)^{\text{tr}} \in \mathbb{R}^n$ and the control is $u = (u_1, \dots, u_m) \in \mathbb{R}^m$. Let us fix $\eta_1 \in \mathbb{R}$, $\eta_2 \in \mathbb{R}$ and $a \in \mathbb{R}^n$. For $\varepsilon > 0$, we consider the following

control $u : (0, 4\varepsilon) \rightarrow \mathbb{R}^m$

$$\begin{aligned} u(t) &= (\eta_1, 0, 0, \dots, 0)^{\text{tr}}, & t \in (0, \varepsilon), \\ u(t) &= (0, \eta_2, 0, \dots, 0)^{\text{tr}}, & t \in (\varepsilon, 2\varepsilon), \\ u(t) &= (-\eta_1, 0, 0, \dots, 0)^{\text{tr}}, & t \in (2\varepsilon, 3\varepsilon), \\ u(t) &= (0, -\eta_2, 0, \dots, 0)^{\text{tr}}, & t \in (3\varepsilon, 4\varepsilon). \end{aligned}$$

Let $y : [0, 4\varepsilon] \rightarrow \mathbb{R}^n$ be the solution of the Cauchy problem $\dot{y} = \sum_{i=1}^m u_i(t)f_i(y)$, $y(0) = a$. Straightforward computations lead to

$$y(4\varepsilon) = a + \varepsilon^2 \eta_1 \eta_2 [f_1, f_2](a) + \mathcal{O}(\varepsilon^3) \text{ as } \varepsilon \rightarrow 0.$$

With these controls, starting from a , we have therefore succeeded to move in the directions $[f_1, f_2](a)$ and $-[f_1, f_2](a)$. This can be “iterated”: suitable controls allow to move in the directions $\pm[f_1, [f_1, f_2]](a)$, $\pm[[f_2, f_1], [f_1, [f_1, f_2]]](a)$ etc. (see in particular [76]) and one has the following theorem.

Theorem 2.3 ([63, 16]). *Let $y_e \in \mathbb{R}^n$. Let us assume that*

$$\{h(y_e); h \in \text{Lie}(\{f_1, \dots, f_m\})\} = \mathbb{R}^n. \tag{9}$$

Then the control system (8) is small-time locally controllable at the equilibrium $(y_e, 0) \in \mathbb{R}^n \times \mathbb{R}^m$.

(A proof of this theorem is also given in [23, Section 3.3].) In (9) and in the following, for a nonempty subset \mathcal{E} of $C^\infty(\mathbb{R}^n; \mathbb{R}^n)$, $\text{Lie}(\mathcal{E})$ denotes the Lie algebra generated by \mathcal{E} , i.e. the smallest (for the inclusion) vector subspace \mathcal{V} of $C^\infty(\mathbb{R}^n; \mathbb{R}^n)$ containing \mathcal{E} and such that $[X, Y] \in \mathcal{V}$, for every $X \in \mathcal{V}$ and for every $Y \in \mathcal{V}$.

In fact, for driftless control systems, one can also get a global controllability result relying on iterated Lie brackets. One has the following theorem.

Theorem 2.4 ([63, 16]). *Let Ω be a nonempty open connected subset of \mathbb{R}^n . Let us assume that*

$$\{h(y); h \in \text{Lie}(\{f_1, \dots, f_m\})\} = \mathbb{R}^n, \forall y \in \Omega. \tag{10}$$

Then the control system (8) is globally controllable in every time in Ω in the following sense: For every $y^0 \in \Omega$, for every $y^1 \in \Omega$ and for every $T > 0$, there exists $u \in L^\infty((0, T); \mathbb{R}^m)$ such that the solution of the Cauchy problem

$$\dot{y} = \sum_{i=1}^m u_i(t)f_i(y), \quad y(0) = y^0,$$

satisfies $y(T) = y^1$ and $y([0, T]) \subset \Omega$.

(A proof of this theorem is again also given in [23, Section 3.3].) When (10) does not hold, the set of points which can be reached from a given point while remaining in Ω is an immersed submanifold of Ω whose tangent space can be precisely described: See [73].

Example 6. Let us return to the baby stroller control system (4). This control system can be written as $\dot{y} = u_1 f_1(y) + u_2 f_2(y)$, with $f_1(y) := (\cos y_3, \sin y_3, 0)^{\text{tr}}$ and $f_2(y) := (0, 0, 1)^{\text{tr}}$. One has $[f_1, f_2](y) = (\sin y_3, -\cos y_3, 0)^{\text{tr}}$. Hence $f_1(y)$, $f_2(y)$ and $[f_1, f_2](y)$ span all of \mathbb{R}^3 , for every $y \in \mathbb{R}^3$. This implies the small-time local controllability of the baby stroller at $(y, 0) \in \mathbb{R}^3 \times \mathbb{R}^2$, for every $y \in \mathbb{R}^3$ (see Theorem 2.3) and also the global controllability in every time of this control system (see Theorem 2.4).

When there is a drift term f_0 , iterated Lie brackets are still useful. Let us explain, for example, how to move in the direction $\pm[f_0, f_1]$. Let $\eta \in \mathbb{R}$. Let $a \in \mathbb{R}^n$ be such that $f_0(a) = 0$. Let, for $\varepsilon > 0$, $u : (0, 2\varepsilon) \rightarrow \mathbb{R}^m$ be defined by

$$\begin{aligned} u(t) &:= (-\eta, 0, \dots, 0)^{\text{tr}}, & t \in (0, \varepsilon), \\ u(t) &:= (\eta, 0, \dots, 0)^{\text{tr}}, & t \in (\varepsilon, 2\varepsilon). \end{aligned}$$

Let $y : [0, 2\varepsilon] \rightarrow \mathbb{R}^n$ be the solution of the Cauchy problem

$$\dot{y} = f_0(y) + \sum_{i=1}^m u_i(t) f_i(y), \quad y(0) = a.$$

Straightforward computations lead now to $y(2\varepsilon) = a + \varepsilon^2 \eta [f_0, f_1](a) + \mathcal{O}(\varepsilon^3)$ as $\varepsilon \rightarrow 0$. Hence, starting from a , one can move in the directions $\pm[f_0, f_1](a)$.

Let us emphasize also that the Kalman rank condition (5) is also a condition on (iterated) Lie brackets. Indeed, for $k \in \mathbb{N}$, $X \in C^\infty(\mathbb{R}^n; \mathbb{R}^n)$ and $Y \in C^\infty(\mathbb{R}^n; \mathbb{R}^n)$, one defines $\text{ad}_X^k Y \in C^\infty(\mathbb{R}^n; \mathbb{R}^n)$ by induction on the integer k by $\text{ad}_X^0 Y := Y$, $\text{ad}_X^k Y := [X, \text{ad}_X^{k-1} Y]$. Let us write the linear control system $\dot{y} = Ay + Bu$ as $\dot{y} = f_0(y) + \sum_{i=1}^m u_i f_i(y)$ with

$$f_0(y) := Ay, \quad f_i(y) := B_i, \quad B_i \in \mathbb{R}^n, \quad (B_1, \dots, B_m) := B.$$

Then

$$\text{ad}_{f_0}^k f_i = (-1)^k A^k B_i, \quad \forall k \in \mathbb{N}, \quad \forall i \in \{1, \dots, m\}. \quad (11)$$

Hence the Kalman rank condition (5) can be written in the following way

$$\text{Span} \{ \text{ad}_{f_0}^k f_i(0); k \in \{0, \dots, n-1\}, i \in \{1, \dots, m\} \} = \mathbb{R}^n. \quad (12)$$

Moreover, one easily checks that Kalman rank condition (5) is also equivalent to

$$\{h(0); h \in \text{Lie}(\{f_0, \dots, f_m\})\} = \mathbb{R}^n. \quad (13)$$

It turns out that, for analytic systems, condition (13) is necessary for small-time local controllability at the equilibrium $(0, 0)$: One has the following theorem.

Theorem 2.5 ([46, 62]). *Assume that*

$$f_0(y_e) = 0. \tag{14}$$

Assume that the control system (2) is small-time locally controllable at the equilibrium point $(y_e, 0)$ and that the f_i 's ($i \in \{0, \dots, m\}$) are analytic. Then

$$\{h(y_e); h \in \text{Lie}(\{f_0, \dots, f_m\})\} = \mathbb{R}^n. \tag{15}$$

Hence, condition (15) is necessary for small-time local controllability of analytic control systems (Theorem 2.5) and is also sufficient for small-time local controllability for control systems without drift (Theorem 2.3) as well as for linear control systems (Theorem 2.1 and (11)). However this condition is far from being sufficient for small-time local controllability in general. Let us give a simple example. We take $n = 2$ and $m = 1$ and consider the control system

$$\dot{y}_1 = y_2^2, \dot{y}_2 = u, \tag{16}$$

where the state is $y := (y_1, y_2)^{\text{tr}} \in \mathbb{R}^2$ and the control is $u \in \mathbb{R}$. This control system can be written as $\dot{y} = f_0(y) + uf_1(y)$ with $f_0(y) := (y_2^2, 0)^{\text{tr}}$, $f_1(y) := (0, 1)^{\text{tr}}$. One has $[f_1, [f_1, f_0]] = (2, 0)^{\text{tr}}$ and therefore $f_1(0)$ and $[f_1, [f_1, f_0]](0)$ span all of \mathbb{R}^2 . However the control system (16) is clearly not small-time locally controllable at the equilibrium $(0, 0) \in \mathbb{R}^2 \times \mathbb{R}$ since $\dot{y}_1 \geq 0$.

One knows powerful sufficient conditions for small-time local controllability. Let us mention, in particular, [1, 2, 3, 9, 10, 54, 34, 74, 75, 77] and references therein. One knows also powerful necessary conditions which are stronger than the one given in Theorem 2.5. See, in particular, [74, Proposition 6.3] and [72]. However, one does not know an (interesting) necessary and sufficient condition for small-time local controllability. One has the following challenging open problem.

Open problem 2.6. *Let k be a positive integer. Let \mathcal{X}_k be the set of vector fields in \mathbb{R}^n whose components are polynomials of degree k . Let*

$$S := \{(f_0, f_1) \in \mathcal{X}_k \times \mathcal{X}_k; f_0(0) = 0, \dot{y} = f_0(y) + uf_1(y) \text{ is STLC}\}.$$

Is S a semi-algebraic set?

Let us recall that a semi-algebraic set is a subset of a real finite dimensional space (here \mathcal{X}_k^2) defined by a finite sequence of polynomial equations and polynomial inequalities on the coordinates or any finite union of such sets. Let us point out that the set of $(f_0, f_1) \in \mathcal{X}_k^2$ satisfying the Lie algebra rank condition (15) at $y_e = 0$ is a semi-algebraic set: See [64, 41, 40].

3. Controllability of PDE Control Systems

We now turn to the cases of control systems modeled by partial differential equations. Again the simplest cases concern the case of linear partial differential

equations. There are many powerful tools to study the controllability of linear control systems in infinite dimension. The most popular ones are based on the duality between observability and controllability (related to the J.-L. Lions Hilbert uniqueness method [58, 59]). This leads to try to prove observability inequalities. There are many methods to prove these observability inequalities. For example, let us mention the following methods (together with the pioneering works where they have been introduced in control theory)

- Ingham's inequalities [67],
- Multipliers method [47, 58, 59],
- Microlocal analysis [5],
- Carleman's inequalities [49, 56, 50, 36]. (See also [78] in these proceedings.)

However there are still plenty of open problems on the controllability of linear partial differential equations.

Of course, when one wants to study the local controllability around an equilibrium of a control system in infinite dimension, the first step is again to study the controllability of the linearized control system. If this linearized control system is controllable, one can usually deduce the local controllability of the nonlinear system. However this might be sometimes difficult due to some loss of derivatives issues. One may need to use suitable complicated iterative schemes. If the nonlinearity is not too big at infinity, one can get a global controllability result (see in particular [79, 55, 80] for semilinear wave equations and [31, 36, 33] for semilinear parabolic equations).

Let us now focus on cases where either the linearized control system around the equilibrium is not controllable or when the nonlinearity is too big at infinity to use this method for global controllability. Let us start with an example for the first case, namely the Euler control system. (For the second case, see the Navier-Stokes control system below.) Let Ω be a smooth connected nonempty bounded open subset of \mathbb{R}^n . Let Γ_0 be a nonempty open subset of the boundary $\partial\Omega$ of Ω . We denote by $\nu : \partial\Omega \rightarrow \mathbb{R}^n$ the outward unit normal vector field to Ω . The controllability problem is the following one. Let $T > 0$. Let $y^0, y^1 : \bar{\Omega} \rightarrow \mathbb{R}^n$ be such that

$$\operatorname{div} y^0 = \operatorname{div} y^1 = 0 \text{ in } \Omega \text{ and } y^0 \cdot \nu = y^1 \cdot \nu = 0 \text{ on } \partial\Omega \setminus \Gamma_0. \quad (17)$$

Does there exist $y : [0, T] \times \bar{\Omega} \rightarrow \mathbb{R}^n$ and $p : [0, T] \times \bar{\Omega} \rightarrow \mathbb{R}$ such that

$$y_t + (y \cdot \nabla)y + \nabla p = 0, \operatorname{div} y = 0, \text{ in } (0, T) \times \Omega, \quad (18)$$

$$y \cdot \nu = 0 \text{ on } [0, T] \times (\partial\Omega \setminus \Gamma_0), \quad (19)$$

$$y(0, \cdot) = y^0, y(T, \cdot) = y^1? \quad (20)$$

(For simplicity we do not specify the regularity of y^0, y^1, y, p etc: For these regularities, see the given references.) This system models the flow in Ω of an inviscid, incompressible fluid with constant density, which is equal to one without loss of generality. The vector $y(t, x) \in \mathbb{R}^n$ is the velocity of the fluid and $p(t, x) \in \mathbb{R}$ is the pressure, both at time t and position $x \in \Omega$. Condition (19) states that the fluid does not flow through the boundary $\partial\Omega \setminus \Gamma_0$: It slips on this boundary without friction. The first equation of (18) is Newton's second law: It states that the acceleration of a fluid particle is proportional to the pressure-force acting on it. The second equation of (18) is the incompressibility condition: It states that the volume of any part of the fluid does not change under the flow.

Note that, in the above formulation, the control does not appear explicitly: We consider a control system as an underdetermined equation. However one can specify the control if one wants to do so. Many choices are in fact possible. For example, one can take as the control $y \cdot \nu$ on Γ_0 with $\int_{\Gamma_0} y \cdot \nu = 0$ together with $\text{curl } y$ if $n = 2$ and the tangent vector $(\text{curl } y) \times \nu$ if $n = 3$ at the points of $[0, T] \times \Gamma_0$ where $y \cdot \nu < 0$, where $\text{curl } y$ is the vorticity of the velocity field y .

The problem of the controllability of this control system (and of the Navier-Stokes control system considered below) has been raised in [60, 61].

We start by giving an obstruction to the controllability for $n = 2$, when there is a connected component Γ_1 of $\partial\Omega$ which does not meet Γ_0 . Let γ_0 be a given curve in $\bar{\Omega}$. Let, for $t \in [0, T]$, $\gamma(t)$ be the Jordan curve obtained, at time $t \in [0, T]$, from the points of the fluids which, at time 0, were on γ_0 . The Kelvin law tells us that, if $\gamma(t)$ does not intersect Γ_0 , $\int_{\gamma(t)} y(t, \cdot) \cdot \vec{ds} = \int_{\gamma_0} y(0, \cdot) \cdot \vec{ds}$, $\forall t \in [0, T]$. We take $\gamma_0 := \Gamma_1$. Then $\gamma(t) = \Gamma_1$ for every $t \in [0, T]$. Hence, if $\int_{\Gamma_1} y^1 \cdot \vec{ds} \neq \int_{\Gamma_1} y^0 \cdot \vec{ds}$, one cannot steer the control system from y^0 to y^1 .

More generally, for every $n \in \{2, 3\}$, if Γ_0 does not intersect every connected component of the boundary $\partial\Omega$ of Ω , the Euler control system is not controllable. This is the only obstruction to the controllability of the Euler control system. Indeed, one has the following theorem.

Theorem 3.1 ([18, 21] for $n = 2$ and [42, 43] for $n = 3$). *Assume that Γ_0 intersects every connected component of $\partial\Omega$. Then the Euler control system is globally controllable in every time: For every $T > 0$, for every $y^0, y^1 : \Omega \rightarrow \mathbb{R}^n$ such that (17) holds, there exist $y : [0, T] \times \bar{\Omega} \rightarrow \mathbb{R}^n$ and $p : [0, T] \times \bar{\Omega} \rightarrow \mathbb{R}$ such that (18), (19) and (20) hold.*

Let us sketch the main ideas of the proof of this controllability result. For simplicity we assume that $n = 2$. One first studies (as usual) the controllability of the linearized control system around 0. This linearized control system is the underdetermined system

$$y_t + \nabla p = 0, \text{div } y = 0, \text{ in } (0, T) \times \Omega, \text{ and } y \cdot \nu = 0 \text{ on } [0, T] \times (\partial\Omega \setminus \Gamma_0). \tag{21}$$

Taking the curl of the first equation of (21), one gets $(\operatorname{curl} y)_t = 0$. Thus $\operatorname{curl} y$ is constant along the trajectories for the linearized control system, which shows that (21) is not controllable.

In Section 2, for finite dimensional control systems, we saw that when the linearized control system is not controllable, the usual tool to use is (iterated) Lie brackets. This can also be used for some infinite dimensional control systems. See in particular [4, 68] for Euler and Navier-Stokes equations and [13] for a Schrödinger equation. However one does not know how to use this tool for numerous examples of infinite dimensional control systems (including our Euler control system). Let us explain the difficulty on the simplest PDE control system, namely

$$y_t + y_x = 0, \quad t \in (0, T), \quad x \in (0, L), \quad \text{and } y(t, 0) = u(t), \quad t \in (0, T). \quad (22)$$

This is a control system where, at time t , the state is $y(t, \cdot) : (0, L) \rightarrow \mathbb{R}$ and the control is $u(t) \in \mathbb{R}$. A natural state space is $\mathcal{Y} := L^2(0, L)$ and for the control u it then suffices to take $u \in L^2(0, T)$ in order to have a well-posed Cauchy problem. Of course, using the explicit expression of the solutions of (22), it is easy to see that this control system is controllable on $[0, T]$ if and only if $T \geq L$. Let us try to understand what is $[f_0, f_1]$ for the control system (22). We proceed as in Section 2. Let $\eta \in \mathbb{R}$. Let us consider, for $\varepsilon > 0$, the control defined on $[0, 2\varepsilon]$ by

$$u(t) := -\eta \text{ for } t \in (0, \varepsilon), \quad u(t) := \eta \text{ for } t \in (\varepsilon, 2\varepsilon).$$

Let $y : (0, 2\varepsilon) \times (0, L) \rightarrow \mathbb{R}$ be the (weak) solution of the Cauchy problem

$$\begin{aligned} y_t + y_x &= 0, \quad t \in (0, 2\varepsilon), \quad x \in (0, L), \\ y(t, 0) &= u(t), \quad t \in (0, 2\varepsilon), \quad y(0, x) = 0, \quad x \in (0, L). \end{aligned}$$

Then one readily gets, if $2\varepsilon \leq L$,

$$y(2\varepsilon, x) = \eta, \quad x \in (0, \varepsilon), \quad y(2\varepsilon, x) = -\eta, \quad x \in (\varepsilon, 2\varepsilon), \quad y(2\varepsilon, x) = 0, \quad x \in (2\varepsilon, L).$$

Unfortunately

$$\left| \frac{y(2\varepsilon, \cdot) - y(0, \cdot)}{\varepsilon^2} \right|_{L^2(0, L)} \rightarrow +\infty \text{ as } \varepsilon \rightarrow 0^+.$$

In fact, for every $\phi \in H^2(0, L)$, one gets, after suitable computations,

$$\lim_{\varepsilon \rightarrow 0^+} \frac{1}{\varepsilon^2} \int_0^L \phi(x)(y(2\varepsilon, x) - y(0, x)) dx = -\eta \phi'(0). \quad (23)$$

So, in some sense, (23) says that, for the control system (22), $[f_0, f_1](0) = \delta'_0$. Unfortunately it is not clear how to use this derivative of a Dirac mass at 0 in the framework of our controllability problem.

Remark 3.2. *In fact the above problem already appears for $f_1 = \text{ad}_{f_0}^0 f_1$. Proceeding as for $[f_0, f_1]$, one finds that, in some sense, we could say that, for the control system (22), $\text{ad}_{f_0}^0 f_1(0) = \delta_0$.*

In order to overcome this difficulty, we use the return method, a method introduced in [17] for a stabilization problem. Let us explain this method first in the framework of the local controllability of a control system in finite dimension. Thus we consider the control system $\dot{y} = f(y, u)$, where $y \in \mathbb{R}^n$ is the state and $u \in \mathbb{R}^m$ is the control. We assume that f is of class C^∞ and satisfies $f(0, 0) = 0$. The return method consists in reducing the local controllability of a nonlinear control system to the existence of suitable trajectories and to the controllability of linear systems. The idea is the following one: Assume that, for every positive real number T and every positive real number ε , there exists a measurable bounded function $\bar{u} : [0, T] \rightarrow \mathbb{R}^m$ with $\|\bar{u}\|_{L^\infty(0, T)} \leq \varepsilon$ such that, if we denote by \bar{y} the (maximal) solution of $\dot{\bar{y}} = f(\bar{y}, \bar{u}(t))$, $\bar{y}(0) = 0$, then

$$\bar{y}(T) = 0, \tag{24}$$

$$\text{the linearized control system around } (\bar{y}, \bar{u}) \text{ is controllable on } [0, T]. \tag{25}$$

Then, from the inverse mapping theorem, one gets the existence of $\eta > 0$ such that, for every $y^0 \in \mathbb{R}^n$ and for every $y^1 \in \mathbb{R}^n$ such that $|y^0| < \eta$ and $|y^1| < \eta$, there exists $u \in L^\infty((0, T); \mathbb{R}^m)$ such that

$$|u(t) - \bar{u}(t)| \leq \varepsilon, \quad t \in (0, T),$$

and such that, if $y : [0, T] \rightarrow \mathbb{R}^n$ is the solution of the Cauchy problem $\dot{y} = f(y, u(t))$, $y(0) = y^0$, then $y(T) = y^1$. Since $T > 0$ and $\varepsilon > 0$ are arbitrary, one gets that $\dot{x} = f(x, u)$ is small-time locally controllable at the equilibrium $(0, 0) \in \mathbb{R}^n \times \mathbb{R}^m$.

Let us show how this method works on the baby stroller control system (4). For every $\bar{u} \in C^\infty([0, T]; \rightarrow \mathbb{R}^2)$ such that, for every t in $[0, T]$, $\bar{u}(T-t) = -\bar{u}(t)$, every solution $\bar{y} : [0, T] \rightarrow \mathbb{R}^3$ of $\dot{\bar{y}}_1 = \bar{u}_1 \cos \bar{y}_3$, $\dot{\bar{y}}_2 = \bar{u}_1 \sin \bar{y}_3$, $\dot{\bar{y}}_3 = \bar{u}_2$, satisfies $\bar{y}(0) = \bar{y}(T)$. We impose $\bar{y}(0) = 0$. We then have $\bar{y}(T) = 0$. The linearized control system around (\bar{y}, \bar{u}) is

$$\dot{y}_1 = -\bar{u}_1 y_3 \sin \bar{y}_3 + u_1 \cos \bar{y}_3, \quad \dot{y}_2 = \bar{u}_1 y_3 \cos \bar{y}_3 + u_1 \sin \bar{y}_3, \quad \dot{y}_3 = u_2. \tag{26}$$

Using a Kalman rank condition for time varying linear systems (see [69] or [23, Theorem 1.18, page 11]), one can easily check that the linear control system (26) is controllable if (and only if) $\bar{u} \neq 0$. Hence we have given a new proof of the small-time local controllability of the baby stroller control system (4) at $(0, 0) \in \mathbb{R}^3 \times \mathbb{R}^2$ which does not use Lie brackets: this proof uses only controllability results for linear (time-varying) control systems.

The next proposition shows some kind of converse: The return method essentially always works if the control system is small-time locally controllable. More precisely, let us go back to the control system (2) and assume that (14) holds.

We also assume that (15) holds. (Let us recall that, if the f_i 's are analytic, (15) is a necessary condition for small-time local controllability at $(y_e, 0) \in \mathbb{R}^n \times \mathbb{R}^m$: See Theorem 2.5). Then one has the following proposition.

Proposition 3.3 ([70, 19]). *Let us assume that the control system (2) is small-time locally controllable at $(y_e, 0) \in \mathbb{R}^n \times \mathbb{R}^m$. Then, for every $\varepsilon > 0$, there exists $\bar{u} \in L^\infty((0, \varepsilon); \mathbb{R}^m)$ satisfying $|u(t)| \leq \varepsilon$ for almost every $t \in (0, T)$ such that, if $\bar{y} : [0, \varepsilon] \rightarrow \mathbb{R}^n$ is the solution of $\dot{\bar{y}} = f(\bar{y}, \bar{u}(t))$, $\bar{y}(0) = y_e$, then*

$$\bar{y}(T) = y_e,$$

the linearized control system around (\bar{y}, \bar{u}) is controllable.

However there is a fundamental drawback for the return method: it does not provide any insight on strategies to construct (\bar{y}, \bar{u}) .

Let us show how to construct (\bar{y}, \bar{u}) for our Euler control system. One looks for $(\bar{y}, \bar{p}) : [0, T] \times \bar{\Omega} \rightarrow \mathbb{R}^n \times \mathbb{R}$ such that

$$\bar{y}_t + (\bar{y} \cdot \nabla \bar{y}) + \nabla \bar{p} = 0, \quad \operatorname{div} \bar{y} = 0, \quad \text{in } (0, T) \times \Omega, \quad (27)$$

$$\bar{y} \cdot \nu = 0 \quad \text{on } [0, T] \times (\partial\Omega \setminus \Gamma_0), \quad (28)$$

$$\bar{y}(T, \cdot) = \bar{y}(0, \cdot) = 0, \quad (29)$$

$$\text{the linearized control system around } (\bar{y}, \bar{p}) \text{ is controllable.} \quad (30)$$

We construct (\bar{y}, \bar{p}) if $n = 2$ and Ω is simply connected. Let us take $\theta : \bar{\Omega} \rightarrow \mathbb{R}$ such that

$$\Delta\theta = 0 \text{ in } \Omega, \quad \frac{\partial\theta}{\partial\nu} = 0 \text{ on } \partial\Omega \setminus \Gamma_0. \quad (31)$$

Then, let $\alpha : [0, T] \rightarrow [0, +\infty)$ be such that $\alpha(0) = \alpha(T) = 0$. Finally, we define $(\bar{y}, \bar{p}) : [0, T] \times \bar{\Omega} \rightarrow \mathbb{R}^2 \times \mathbb{R}$ by

$$\bar{y}(t, x) := \alpha(t)\nabla\theta(x), \quad \bar{p}(t, x) := -\dot{\alpha}(t)\theta(x) - \frac{\alpha(t)^2}{2}|\nabla\theta(x)|^2.$$

Then (\bar{y}, \bar{p}) is a trajectory of the Euler control system which goes from 0 to 0, i.e. it satisfies (27)–(28)–(29). Let us now study (30). The linearized control system around (\bar{y}, \bar{p}) is

$$\begin{cases} y_t + (\bar{y} \cdot \nabla)y + (y \cdot \nabla)\bar{y} + \nabla p = 0, & \operatorname{div} y = 0, & \text{in } [0, T] \times \Omega, \\ y \cdot \nu = 0 & \text{on } [0, T] \times (\partial\Omega \setminus \Gamma_0). \end{cases} \quad (32)$$

Taking once more the curl of the first equation, one gets

$$(\operatorname{curl} y)_t + (\bar{y} \cdot \nabla)(\operatorname{curl} y) = 0 \text{ in } [0, T] \times \Omega. \quad (33)$$

This is a simple transport equation on $\operatorname{curl} y$. If there exists $a \in \bar{\Omega}$ such that $\nabla\theta(a) = 0$, then $\bar{y}(t, a) = 0$ and $(\operatorname{curl} y)_t(t, a) = 0$, which shows that (33) is not controllable. This is the only obstruction: If

$$\nabla\theta \text{ does not vanish in } \bar{\Omega}, \quad (34)$$

one can (easily) prove that (33), and then (32), are controllable if $\int_0^T \alpha(t)dt$ is large enough. For the construction of $\theta : \bar{\Omega} \rightarrow \mathbb{R}$ satisfying (31) and (34), let Γ_+ and Γ_- be two nonempty open connected subsets of Γ_0 such that

$$\bar{\Gamma}_+ \cap \bar{\Gamma}_- = \emptyset, \bar{\Gamma}_+ \cup \bar{\Gamma}_- \subset \Gamma_0.$$

Let $g : \partial\Omega \rightarrow \mathbb{R}$ be such that

$$\{x \in \partial\Omega; g(x) > 0\} = \Gamma_+, \{x \in \partial\Omega; g(x) < 0\} = \Gamma_-, \int_{\partial\Omega} g(s)ds = 0.$$

Let $\theta : \bar{\Omega} \rightarrow \mathbb{R}$ be the solution of the following Neumann problem

$$\Delta\theta = 0 \text{ in } \Omega, \frac{\partial\theta}{\partial\nu} = g \text{ on } \partial\Omega, \int_{\Omega} \theta = 0.$$

Then one can check that (34) holds (apply the strong maximum principle to the harmonic conjugate of θ together with Morse or degree theory).

From the above argument, one expects only a local controllability result around 0. However this local controllability result leads to a global controllability result by using the following simple scaling argument, which works in every dimension n . If $(y, p) : [0, 1] \times \bar{\Omega} \rightarrow \mathbb{R}^n \times \mathbb{R}$ is a solution of our Euler control system (18)-(19), then, for every $\varepsilon > 0$, $(y^\varepsilon, p^\varepsilon) : [0, \varepsilon] \times \bar{\Omega} \rightarrow \mathbb{R}^n \times \mathbb{R}$ defined by

$$y^\varepsilon(t, x) := \frac{1}{\varepsilon}y\left(\frac{t}{\varepsilon}, x\right), p^\varepsilon(t, x) := \frac{1}{\varepsilon^2}p\left(\frac{t}{\varepsilon}, x\right)$$

is also a solution of our Euler control system.

Let us now turn to the controllability of a Navier-Stokes control system. The Navier-Stokes control system is deduced from the Euler control system by adding the linear term $-\mu\Delta y$: The equation is now

$$y_t - \mu\Delta y + (y \cdot \nabla)y + \nabla p = 0, \text{ div } y = 0, \text{ in } (0, T) \times \Omega, \tag{35}$$

where $\mu > 0$ is the viscosity of the fluid (a positive constant). For the boundary condition, one requires now that

$$y = 0 \text{ on } [0, T] \times (\partial\Omega \setminus \Gamma_0), \tag{36}$$

meaning that the viscous fluid sticks to the boundary $\partial\Omega \setminus \Gamma_0$. Here, for the control u , one can take, for example, $y = u$ on $[0, T] \times \Gamma_0$.

Due to the regularizing effect of the Navier-Stokes equations, the “right” controllability problem is not to go from a given state to another given state. The right problem is to go from a state to a given trajectory. For simplicity we assume that this given trajectory is 0. The controllability problem is then the following one. Let $T > 0$. Let $y^0 : \bar{\Omega} \rightarrow \mathbb{R}^n$ be such that

$$\text{div } y^0 = 0 \text{ in } \Omega, y^0 = 0 \text{ on } \partial\Omega \setminus \Gamma_0,$$

Does there exist $y : [0, T] \times \bar{\Omega} \rightarrow \mathbb{R}^n$ and $p : [0, T] \times \bar{\Omega} \rightarrow \mathbb{R}$ such that (35) (36) hold, $y(0, \cdot) = y^0$ and $y(T, \cdot) = 0$? One has the following theorem.

Theorem 3.4 ([51, 52]; see also [35, 37, 38, 32]). *Such a (y, p) exists if y^0 is small enough (in $L^{2n-2}(\Omega)^n$).*

A challenging open problem is the following one.

Open problem 3.5. *Does (y, p) exist even if y^0 is not small?*

One has a positive answer to this problem if $\Gamma_0 = \partial\Omega$:

Theorem 3.6 ([20, 25, 39]). *Such a (y, p) always exists if $\Gamma_0 = \partial\Omega$.*

Note that the linearized control system around $(0, 0)$ is controllable (this is a key point for the proof of Theorem 3.4 and this property is known to be true even if $\Gamma_0 \neq \partial\Omega$). However this result seems to give only a local controllability result (i.e. Theorem 3.4). The main idea is to consider other trajectories going from 0 to 0 which have a better controllability around them. Let us explain this in the context of a linear perturbation of a quadratic control system in finite dimension. We consider the following control system

$$\dot{y} = F(y) + Bu(t), \quad (37)$$

where the state is $y \in \mathbb{R}^n$, the control is $u \in \mathbb{R}^m$, B is a $n \times m$ matrix and $F \in C^1(\mathbb{R}^n; \mathbb{R}^n)$ is quadratic: $F(\lambda y) = \lambda^2 F(y)$, $\forall \lambda \in [0, +\infty)$, $\forall y \in \mathbb{R}^n$. We assume that there exists a trajectory $(\bar{y}, \bar{u}) \in C^0([0, T_0]; \mathbb{R}^n) \times L^\infty((0, T_0); \mathbb{R}^m)$ of the control system (37) such that the linearized control system around (\bar{y}, \bar{u}) is controllable and such that $\bar{y}(0) = \bar{y}(T_0) = 0$.

Remark 3.7. *One has $F(0) = 0$. Hence $(0, 0)$ is an equilibrium of the control system (37). The linearized control system around this equilibrium is $\dot{y} = Bu$, which is not controllable if (and only if) B is not onto.*

Let A be a $n \times n$ matrix and let us consider the following control system

$$\dot{y} = Ay + F(y) + Bu(t), \quad (38)$$

where the state is $y \in \mathbb{R}^n$, the control is $u \in \mathbb{R}^m$. For the application to incompressible fluids, (37) is the Euler control system and (38) is the Navier-Stokes control system.

One has the following (easy) theorem.

Theorem 3.8. *Under the above assumptions, the control system (38) is globally controllable in arbitrary time: For every $T > 0$, for every $y^0 \in \mathbb{R}^n$ and for every $y^1 \in \mathbb{R}^n$, there exists $u \in L^\infty((0, T); \mathbb{R}^m)$ such that*

$$(\dot{y} = f(y, u(t)), y(0) = y^0) \Rightarrow (y(T) = y^1).$$

Proof of Theorem 3.8. Let $y^0 \in \mathbb{R}^n$ and $y^1 \in \mathbb{R}^n$. Let

$$G : \mathbb{R} \times L^\infty((0, T_0); \mathbb{R}^m) \rightarrow \mathbb{R}^n \\ (\varepsilon, \tilde{u}) \mapsto \tilde{y}(T_0) - \varepsilon y^1$$

where $\tilde{y} : [0, T_0] \rightarrow \mathbb{R}^n$ is the solution of $\dot{\tilde{y}} = F(\tilde{y}) + \varepsilon A\tilde{y} + B\tilde{u}(t)$, $\tilde{y}(0) = \varepsilon y^0$. The map G is of class C^1 in a neighborhood of $(0, \bar{u})$. One has $G(0, \bar{u}) = 0$. Moreover $G'_u(0, \bar{u})v = y(T_0)$ where $y : [0, T_0] \rightarrow \mathbb{R}^n$ is the solution of $\dot{y} = F'(y)y + Bv$, $y(0) = 0$. Hence $G'_u(0, \bar{u})$ is onto. Therefore there exist $\varepsilon_0 > 0$ and a C^1 -map $\varepsilon \in (-\varepsilon_0, \varepsilon_0) \mapsto \tilde{u}^\varepsilon \in L^\infty((0, T_0); \mathbb{R}^m)$ such that

$$G(\varepsilon, \tilde{u}^\varepsilon) = 0, \forall \varepsilon \in (-\varepsilon_0, \varepsilon_0),$$

$$\tilde{u}^0 = \bar{u}.$$

Let $\tilde{y}^\varepsilon : [0, T_0] \rightarrow \mathbb{R}^n$ be the solution of the Cauchy problem $\dot{\tilde{y}}^\varepsilon = F(\tilde{y}^\varepsilon) + \varepsilon A\tilde{y}^\varepsilon + B\tilde{u}^\varepsilon(t)$, $\tilde{y}^\varepsilon(0) = \varepsilon y^0$. Then $\tilde{y}^\varepsilon(T_0) = \varepsilon y^1$. Let $y : [0, \varepsilon T_0] \rightarrow \mathbb{R}^n$ and $u : [0, \varepsilon T_0] \rightarrow \mathbb{R}^m$ be defined by

$$y(t) := \frac{1}{\varepsilon} \tilde{y}^\varepsilon\left(\frac{t}{\varepsilon}\right), u(t) := \frac{1}{\varepsilon^2} \tilde{u}^\varepsilon\left(\frac{t}{\varepsilon}\right).$$

Then $\dot{y} = F(y) + Ay + Bu$, $y(0) = y^0$ and $y(\varepsilon T_0) = y^1$. This concludes the proof of Theorem 3.8 if T is small enough. If T is not small, it suffices, with $\varepsilon > 0$ small enough, to go from y^0 to 0 during the interval of time $[0, \varepsilon]$, stay at 0 during the interval of time $[\varepsilon, T - \varepsilon]$ and finally go from 0 to y^1 during the interval of time $[T - \varepsilon, T]$.

The ‘‘morality’’ behind Theorem 3.8 is that the quadratic term $F(y)$ wins against the linear term Ay . Note, however, that for Euler/Navier-Stokes equations the linear term $\mu\Delta y$ contains more derivatives than the quadratic term $(y \cdot \nabla)y$. This creates many new difficulties and the proof requires important modifications. In particular, one first gets a global approximate controllability result and then concludes with a local controllability result (see Theorem 3.4).

Of course, as one can see by looking at the proof of Theorem 3.8, this method works only if we have a (good) convergence of the solution of the Navier-Stokes equations to the solution of the Euler equations when the viscosity tends to 0. Let us recall that this is not known even in dimension $n = 2$ if there is no control. More precisely, let us assume that Ω is of class C^∞ , that $n = 2$ and that $\varphi \in C_0^\infty(\Omega; \mathbb{R}^2)$ is such that $\operatorname{div} \varphi = 0$. Let $T > 0$. Let $y \in C^\infty([0, T] \times \bar{\Omega}; \mathbb{R}^2)$ and $p \in C^\infty([0, T] \times \bar{\Omega})$ be the solution to the Euler equations

$$(E) \begin{cases} y_t + (y \cdot \nabla)y + \nabla p = 0, \operatorname{div} y = 0, \text{ in } (0, T) \times \Omega, \\ y \cdot \nu = 0 \text{ on } [0, T] \times \partial\Omega, \\ y(0, \cdot) = \varphi \text{ on } \bar{\Omega}. \end{cases}$$

Let $\varepsilon \in (0, 1]$. Let $y^\varepsilon \in C^\infty([0, T] \times \bar{\Omega}; \mathbb{R}^2)$ and $p^\varepsilon \in C^\infty([0, T] \times \bar{\Omega})$ be the solution to the Navier-Stokes equations

$$(NS) \begin{cases} y_t^\varepsilon - \varepsilon\Delta y^\varepsilon + (y^\varepsilon \cdot \nabla)y^\varepsilon + \nabla p^\varepsilon = 0, \operatorname{div} y^\varepsilon = 0, \text{ in } (0, T) \times \Omega, \\ y^\varepsilon = 0 \text{ on } [0, T] \times \partial\Omega, \\ y^\varepsilon(0, \cdot) = \varphi \text{ on } \bar{\Omega}. \end{cases}$$

One knows that there exists $C > 0$ such that $|y^\varepsilon|_{C^0([0, T]; L^2(\Omega; \mathbb{R}^2))} \leq C$, for every $\varepsilon \in (0, 1]$. One has the following challenging open problem.

Open problem 3.9. (i) Does y^ε converge weakly to y in $L^2((0, T) \times \Omega; \mathbb{R}^2)$ as $\varepsilon \rightarrow 0^+$?

(ii) Let K be a compact subset of Ω and m be a positive integer. Does $y_{|[0, T] \times K}^\varepsilon$ converge to $y_{|[0, T] \times K}$ in $C^m([0, T] \times K; \mathbb{R}^2)$ as $\varepsilon \rightarrow 0^+$? (Of course, due to the difference of boundary conditions between the Euler equations and the Navier-Stokes equations, one does not have a positive answer to this last question if $K = \overline{\Omega}$.)

The return method turns out to give controllability results on many other partial differential equations, for example, Burgers equations [48, 15, 53], Saint-Venant equations [22] (see also below), Vlasov Poisson equations [44], Isentropic Euler equations [45], Schrödinger equations [6, 7], Korteweg-de Vries equations [14], Hyperbolic equation [26], Navier-Stokes equations with a control force having a vanishing component [27], Ensemble controllability of Bloch equation [8]. For finite dimensional control systems, this method is much less interesting since one then has at one's disposal the powerful tool of iterated Lie brackets; see however [71].

As mentioned above, there is an important difficulty in the application of the return method, namely it is often difficult to construct the reference trajectory (\bar{y}, \bar{u}) satisfying $\bar{y}(0) = 0$, (24) and (25). Let us present a method to take care of this problem in some cases and that has been applied to get controllability results for the Saint-Venant equation (shallow water equation) in [22] (which is motivated by [30]) and a Schrödinger equation [6, 7] (which is motivated by [66]). Let us deal with the control system modeled by the Saint-Venant equation. It concerns the motion of a 1-D tank containing an inviscid incompressible irrotational fluid. The tank is subject to one-dimensional horizontal moves. We assume that the horizontal acceleration of the tank is small compared to the gravity constant and that the height of the fluid is small compared to the length of the tank. This motivates the use of the Saint-Venant equations (also called shallow water equations) to describe the motion of the fluid; see e.g. [29, Section 4.2]. After suitable scaling arguments, the length of the tank, the gravity constant and the height of the fluid at rest can be taken to be equal to 1; see [22]. Then the dynamics equations are (see [30])

$$\begin{cases} H_t(t, x) + (Hv)_x(t, x) = 0, \\ v_t(t, x) + \left(H + \frac{v^2}{2}\right)_x(t, x) = -u(t), \\ v(t, 0) = v(t, 1) = 0, \\ \frac{ds}{dt}(t) = u(t), \quad \frac{dD}{dt}(t) = s(t), \end{cases} \quad (39)$$

where, see Figure 3, at time t and position $x \in [0, 1]$,

- $H(t, x)$ is the height of the fluid,

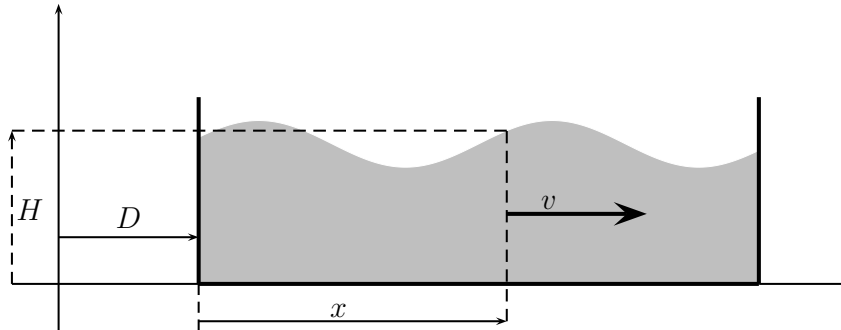

Figure 3. Fluid in the 1-D tank

- $v(t, x)$ is the horizontal water velocity of the fluid *in a referential attached to the tank* (in the Saint-Venant model, the points on the same vertical line have the same horizontal velocity),
- $u(t)$ is the horizontal acceleration of the tank in the absolute referential,
- $s(t)$ is the horizontal velocity of the tank,
- $D(t)$ is the horizontal displacement of the tank.

This is a control system, where at time t , the control is $u(t) \in \mathbb{R}$ and the state is $Y(t) = (H(t, \cdot), v(t, \cdot), s(t), D(t))$.

One is interested in the local controllability of the control system (39) around the equilibrium point $(Y_e, u_e) := ((1, 0, 0, 0), 0)$. Of course, the total mass of the fluid is conserved so that, for every solution of (39),

$$\frac{d}{dt} \int_0^1 H(t, x) dx = 0. \tag{40}$$

(One gets (40) by integrating the first equation of (39) on $[0, 1]$ and by using the third equation of (39).) Moreover, if H and v are of class C^1 , it follows from the second and third equation of (39) that

$$H_x(t, 0) = H_x(t, 1) \quad (= -u(t)). \tag{41}$$

Therefore, we introduce the vector space \mathcal{E} of functions

$$Y = (H, v, s, D) \in C^1([0, 1]) \times C^1([0, 1]) \times \mathbb{R} \times \mathbb{R}$$

such that $H_x(0) = H_x(1)$ and $v(0) = v(1) = 0$. We consider the affine subspace $\mathcal{Y} \subset \mathcal{E}$ of $Y = (H, v, s, D) \in \mathcal{E}$ satisfying

$$\int_0^1 H(x) dx = 1. \tag{42}$$

For general controllability results for 1-D quasilinear hyperbolic systems, let us refer to [57]. However, the results of [57] cannot be applied here since they all deal with cases where the linearized control system around the equilibrium of interest is controllable and, as pointed in [30], the linearized control system of (39) around the equilibrium point (Y_e, u_e) is not controllable. However, as for the Euler control system (18)-(19), the nonlinearity allows to get the controllability: One has the following theorem, where $|\varphi|_1$ denotes the usual C^1 -norm of $\varphi \in C^1([0, 1])$.

Theorem 3.10 ([22]). *There exists $T > 0$ satisfying the following property: For every ε , there exists $\eta > 0$ such that, for every $Y_0 = (H_0, v_0, s_0, D_0) \in \mathcal{Y}$ and for every $Y_1 = (H_1, v_1, s_1, D_1) \in \mathcal{Y}$ such that*

$$|H_0 - 1|_1 + |v_0|_1 + |s_0| + |D_0| < \eta, |H_1 - 1|_1 + |v_1|_1 + |s_1| + |D_1| < \eta,$$

there exists (H, v, s, D, u) satisfying

H and v are in $C^1([0, T] \times [0, 1])$, s and D are in $C^1([0, T])$, u in $C^0([0, T])$,

(39) holds for every $(t, x) \in [0, T] \times [0, 1]$,

$(H(0, \cdot), v(0, \cdot), s(0), D(0)) = Y_0$ and $(H(T, \cdot), v(T, \cdot), s(T), D(T)) = Y_1$,

$|H(t, \cdot) - 1|_1 + |v(t, \cdot)|_1 + |s(t)| + |D(t)| + |u(t)| < \varepsilon, \forall t \in [0, T]$.

Note that, as a consequence of this theorem, it is possible to move the tank from a given position to a desired position with the fluid at rest at the beginning and at the end (see also [30] for such motion for the linearized control system).

For simplicity, we explain some of the main ideas of the proof of Theorem 3.10 on the following toy control problem in finite dimension

$$\dot{y}_1 = y_2, \dot{y}_2 = -y_1 + y_2 y_3 + u, \dot{y}_3 = y_4, \dot{y}_4 = -y_3 + 2y_1 y_2, \quad (43)$$

where the state is $y = (y_1, y_2, y_3, y_4)^{\text{tr}} \in \mathbb{R}^4$ and the control is $u \in \mathbb{R}$. The linearized control system of (43) around $(0, 0) \in \mathbb{R}^4 \times \mathbb{R}$ is

$$\dot{y}_1 = y_2, \dot{y}_2 = -y_1 + u, \dot{y}_3 = y_4, \dot{y}_4 = -y_3. \quad (44)$$

This linear control system is again not controllable (look at $(y_3, y_4)^{\text{tr}}$). The analog of Theorem 3.10 for the control system (43) is the following proposition.

Proposition 3.11. *There exists $T > 0$ such that, for every $\varepsilon > 0$, there exists $\eta > 0$ such that, for every $y^0 \in \mathbb{R}^4$ and every $y^1 \in \mathbb{R}^4$ with $|y^0| < \eta$ and $|y^1| < \eta$, there exists $u \in L^\infty((0, T); \mathbb{R})$ satisfying $|u(t)| < \varepsilon$ for almost every $t \in (0, T)$ and the following property: If $y = (y_1, y_2, y_3, y_4)^{\text{tr}} : [0, T] \rightarrow \mathbb{R}^4$ is the solution of the Cauchy problem*

$$\dot{y}_1 = y_2, \dot{y}_2 = -y_1 + y_2 y_3 + u, \dot{y}_3 = y_4, \dot{y}_4 = -y_3 + 2y_1 y_2, y(0) = y^0,$$

then $y(T) = y^1$.

Let us prove this proposition by using the return method and quasi-static deformations. (Of course, for the finite dimensional control system (43), a simpler method relying on iterated Lie brackets can be used; but one does not know how to adapt this method to the Saint-Venant control system (39).) In order to use the return method, one needs, at least, to know trajectories of the control system (43) such that the linearized control systems around these trajectories are controllable. The simplest trajectories one can consider are the trajectories

$$((y_1^\gamma, y_2^\gamma, y_3^\gamma, y_4^\gamma)^{\text{tr}}, u^\gamma) := ((\gamma, 0, 0, 0)^{\text{tr}}, \gamma), \tag{45}$$

where γ is any real number different from 0. These trajectories are here just equilibrium points (they could be more complicated: for the Saint-Venant and Schrödinger control systems these special trajectories do depend on time). The linearized control system around the trajectory $(y^\gamma, u^\gamma) := ((y_1^\gamma, y_2^\gamma, y_3^\gamma, y_4^\gamma)^{\text{tr}}, u^\gamma)$ is the linear control system

$$\dot{y}_1 = y_2, \dot{y}_2 = -y_1 + u, \dot{y}_3 = y_4, \dot{y}_4 = -y_3 + 2\gamma y_2, \tag{46}$$

Using the usual Kalman rank condition for controllability (Theorem 2.1), one easily checks that this linear control system is small-time locally controllable at $(0, 0) \in \mathbb{R}^4 \times \mathbb{R}$ if (and only if) $\gamma \neq 0$. Let us now choose $\gamma \neq 0$ and $\tau_1 > 0$. Then, by this controllability of (46) and Theorem 2.2, there exists $\delta_1 > 0$ such that for every $y^0 \in B(y^\gamma, \delta_1) := \{y \in \mathbb{R}^4; |y - y^\gamma| < \delta_1\}$ and for every y^1 in $B(y^\gamma, \delta_1)$ there exists $u \in L^\infty((0, \tau_1); \mathbb{R})$ such that $|u(t) - \gamma| < \gamma$ for almost every $t \in (0, \tau_1)$ and

$$\begin{aligned} (\dot{y}_1 = y_2, \dot{y}_2 = -y_1 + y_2 y_3 + u, \dot{y}_3 = y_4, \dot{y}_4 = -y_3 + 2y_1 y_2, y(0) = y^0) \\ \Rightarrow (y(\tau_1) = y^1). \end{aligned}$$

Let us first deal with the weaker statement where one replaces, in Proposition 3.11, “There exists $T > 0$ such that, for every $\varepsilon > 0$, there exists $\eta > 0$ such that...” by “For every $\varepsilon > 0$, there exist $T > 0$ and $\eta > 0$ such that...”. Then, by the continuity of the solutions of the Cauchy problem with respect to the initial condition, it suffices to check that

- (i) there exist $\tau_2 > 0$ and a trajectory $(\tilde{y}, \tilde{u}) : [0, \tau_2] \rightarrow \mathbb{R}^4 \times \mathbb{R}$ of the control system (43) such that $\tilde{y}(0) = 0$ and $|\tilde{y}(\tau_2) - y^\gamma| < \delta_1$.
- (ii) there exist $\tau_3 > \tau_2 + \tau_1$ and a trajectory $(\hat{y}, \hat{u}) : [\tau_2 + \tau_1, \tau_3] \rightarrow \mathbb{R}^4 \times \mathbb{R}$ of the control system (43) such that $\hat{y}(\tau_3) = 0$ and $|\hat{y}(\tau_2 + \tau_1) - y^\gamma| < \delta_1$.

In order to prove (i), we consider quasi-static deformations. Let $g \in C^2([0, 1]; \mathbb{R})$ be such that $g(0) = 0$ and $g(1) = 1$. Let $\tilde{u} : [0, 1/\varepsilon] \rightarrow \mathbb{R}$ be defined by $\tilde{u}(t) = \gamma g(\varepsilon t)$. Let $\tilde{y} := (\tilde{y}_1, \tilde{y}_2, \tilde{y}_3, \tilde{y}_4)^{\text{tr}} : [0, 1/\varepsilon] \rightarrow \mathbb{R}^4$ be defined by

$$\dot{\tilde{y}}_1 = \tilde{y}_2, \dot{\tilde{y}}_2 = -\tilde{y}_1 + \tilde{y}_2 \tilde{y}_3 + \tilde{u}, \dot{\tilde{y}}_3 = \tilde{y}_4, \dot{\tilde{y}}_4 = -\tilde{y}_3 + 2\tilde{y}_1 \tilde{y}_2, \tilde{y}(0) = 0.$$

One easily checks that

$$\tilde{y}(1/\varepsilon) \rightarrow (\gamma, 0, 0, 0)^{\text{tr}} \text{ as } \varepsilon \rightarrow 0,$$

which ends the proof of (i).

In order to get (ii) one just needs to modify a little bit the above construction. In order to have the required statement “There exists $T > 0$ such that, for every $\varepsilon > 0$, there exists $\eta > 0$ such that...”, one needs some further estimates which are omitted.

Remark 3.12. *If $g(y) := (y_2, -y_1 + \gamma + y_2y_3, y_3, -y_3 + 2y_1y_2)^{\text{tr}}$, then the eigenvalues of $g'(y^\gamma)$ are i and $-i$. This is why the quasi-static deformations are so easy to perform. If this linear map had eigenvalues with strictly positive real part, it is still possible to perform in some cases quasi-static deformations by stabilizing the equilibria by suitable feedbacks, as it has been pointed out in [28] for a parabolic equation.*

The method which we have used in order to prove Proposition 3.11 has still an important drawback: Due to the quasi-static deformation parts, it leads to too conservative estimates on the time T for controllability. Let us now propose another method which gives the optimal estimate on the time T for local controllability. This method, called “power series expansion” has been introduced for the first time in infinite dimension for a KdV control system in [24], a paper motivated by [65]. (For other applications of this method, see [7, 11, 12].) This method consists in looking for “higher order variations” which allows to move in the directions which are missed by the controllability of the linearized control system. These directions are $\pm(0, 0, 1, 0)$ and $\pm(0, 0, 0, 1)$ for the control system (43). Let us describe this method in order to show that Proposition 3.11 holds more precisely for every $T > \pi$. (Again, for the finite dimensional control system (43), a simpler method relying on iterated Lie brackets can be used; but, again, one does not know how to adapt these methods to the PDE control systems considered in [24, 7, 11, 12].)

One first looks to the linearized control system around 0, i.e. the linear control system (44). Let $T > 0$ and let $(e_i)_{i \in \{1, \dots, 4\}}$ be the usual basis of \mathbb{R}^4 . One easily sees that, for every $i \in \{1, 2\}$, there exists $u_i \in L^\infty(0, T)$ such that

$$(\dot{y}_1 = y_2, \dot{y}_2 = -y_1 + u_i, \dot{y}_3 = y_4, \dot{y}_4 = -y_3, y(0) = 0) \Rightarrow (y(T) = e_i).$$

Let us assume for the time being that, for every $i \in \{3, 4\}$, there exist $u_i^\pm \in L^\infty(0, T)$ such that

$$\begin{aligned} (\dot{y}_1 = y_2, \dot{y}_2 = -y_1 + u_i^\pm, \dot{y}_3 = y_4, \dot{y}_4 = -y_3 + 2y_1y_2, y(0) = 0) \\ \Rightarrow (y(T) = \pm e_i). \end{aligned} \quad (47)$$

Note that in the left hand side of (47), we have put $\dot{y}_2 = -y_1 + u_i^\pm$ and not $\dot{y}_2 = -y_1 + y_2y_3 + u_i^\pm$. The reason is that the y_i with $i \in \{1, 2\}$ and u

are considered to be of order 1, and the y_i with $i \in \{3, 4\}$ are considered to be of order 2. With this choice of scaling, the left hand side of (47) is the approximation of order 2 of the control system (43). Then, let $b := \sum_{i=1}^4 b_i e_i$. Let, for $i \in \{3, 4\}$,

$$u_i := u_i^+ \text{ if } b_i \geq 0 \text{ and } u_i := u_i^- \text{ if } b_i < 0.$$

Let $u \in L^\infty(0, T)$ be defined by $u := \sum_{i \in \{1, 2\}} b_i u_i + \sum_{i \in \{3, 4\}} |b_i|^{1/2} u_i$. Let $y : [0, T] \rightarrow \mathbb{R}^4$ be the solution of the Cauchy problem

$$\dot{y}_1 = y_2, \dot{y}_2 = -y_1 + y_2 y_3 + u, \dot{y}_3 = y_4, \dot{y}_4 = -y_3 + 2y_1 y_2, y(0) = 0.$$

Then straightforward estimates lead to $y(T) = b + o(b)$ as $b \rightarrow 0$. Hence, using the Brouwer fixed point theorem (and standard estimates on ordinary differential equations), one gets the local controllability of (43) (around $(0, 0) \in \mathbb{R}^4 \times \mathbb{R}$) in the considered time T (and therefore Proposition 3.11 for that T). It then remains to prove the existence of $u_i^\pm \in L^\infty(0, T)$ for every $i \in \{3, 4\}$ and for $T > \pi$. Easy computations show that

$$\begin{aligned} & (\dot{y}_1 = y_2, \dot{y}_3 = y_4, \dot{y}_4 = -y_3 + 2y_1 y_2, y(0) = 0) \\ \Rightarrow & \left(y_3(T) = \int_0^T y_1^2(t) \cos(T - t) dt, y_4(T) = y_1^2(T) - \int_0^T y_1^2(t) \sin(T - t) dt \right). \end{aligned}$$

Then, taking $u_i^\pm := y_1 + \dot{y}_2$, it is not hard to get that the existence of $u_i^\pm \in L^\infty(0, T)$ for every $i \in \{3, 4\}$ holds if (and only if) $T > \pi$. Unfortunately, one does not know how to use this power series expansion method for the Saint-Venant control system (39) and the optimal value of T in Theorem 3.10 is not known.

References

- [1] Andrei A. Agrachev. Newton diagrams and tangent cones to attainable sets. In *Analysis of controlled dynamical systems (Lyon, 1990)*, volume 8 of *Progr. Systems Control Theory*, pages 11–20. Birkhäuser Boston, Boston, MA, 1991.
- [2] Andrei A. Agrachev and Revaz V. Gamkrelidze. Local controllability and semi-groups of diffeomorphisms. *Acta Appl. Math.*, 32(1):1–57, 1993.
- [3] Andrei A. Agrachev and Revaz V. Gamkrelidze. Local controllability for families of diffeomorphisms. *Systems Control Lett.*, 20(1):67–76, 1993.
- [4] Andrei A. Agrachev and Andrei V. Sarychev. Navier-Stokes equations: controllability by means of low modes forcing. *J. Math. Fluid Mech.*, 7(1):108–152, 2005.
- [5] Claude Bardos, Gilles Lebeau, and Jeffrey Rauch. Sharp sufficient conditions for the observation, control, and stabilization of waves from the boundary. *SIAM J. Control Optim.*, 30(5):1024–1065, 1992.

-
- [6] Karine Beauchard. Local controllability of a 1-D Schrödinger equation. *J. Math. Pures Appl. (9)*, 84(7):851–956, 2005.
- [7] Karine Beauchard and Jean-Michel Coron. Controllability of a quantum particle in a moving potential well. *J. Funct. Anal.*, 232(2):328–389, 2006.
- [8] Karine Beauchard, Jean-Michel Coron, and Pierre Rouchon. Controllability issues for continuous-spectrum systems and ensemble controllability of Bloch equations. *Comm. Math. Phys.*, 296(2):525–557, 2010.
- [9] Rosa Maria Bianchini. High order necessary optimality conditions. *Rend. Sem. Mat. Univ. Politec. Torino*, 56(4):41–51 (2001), 1998. Control theory and its applications (Grado, 1998).
- [10] Rosa Maria Bianchini and Gianna Stefani. Sufficient conditions for local controllability. *Proc. 25th IEEE Conf. Decision and Control, Athens*, pages 967–970, 1986.
- [11] Eduardo Cerpa. Exact controllability of a nonlinear Korteweg-de Vries equation on a critical spatial domain. *SIAM J. Control Optim.*, 46(3):877–899 (electronic), 2007.
- [12] Eduardo Cerpa and Emmanuelle Crépeau. Boundary controllability for the nonlinear Korteweg-de Vries equation on any critical domain. *Ann. Inst. H. Poincaré Anal. Non Linéaire*, 26(2):457–475, 2009.
- [13] Thomas Chambrion, Paolo Mason, Mario Sigalotti, and Ugo Boscain. Controllability of the discrete-spectrum Schrödinger equation driven by an external field. *Ann. Inst. H. Poincaré Anal. Non Linéaire*, 26(1):329–349, 2009.
- [14] Marianne Chapouly. Global controllability of a nonlinear Korteweg-de Vries equation. *Commun. Contemp. Math.*, 11(3):495–521, 2009.
- [15] Marianne Chapouly. Global controllability of nonviscous and viscous Burgers-type equations. *SIAM J. Control Optim.*, 48(3):1567–1599, 2009.
- [16] Wei-Liang Chow. Über Systeme von linearen partiellen Differentialgleichungen erster Ordnung. *Math. Ann.*, 117:98–105, 1939.
- [17] Jean-Michel Coron. Global asymptotic stabilization for controllable systems without drift. *Math. Control Signals Systems*, 5(3):295–312, 1992.
- [18] Jean-Michel Coron. Contrôlabilité exacte frontière de l'équation d'Euler des fluides parfaits incompressibles bidimensionnels. *C. R. Acad. Sci. Paris Sér. I Math.*, 317(3):271–276, 1993.
- [19] Jean-Michel Coron. Linearized control systems and applications to smooth stabilization. *SIAM J. Control Optim.*, 32(2):358–386, 1994.
- [20] Jean-Michel Coron. On the controllability of the 2-D incompressible Navier-Stokes equations with the Navier slip boundary conditions. *ESAIM Control Optim. Calc. Var.*, 1:35–75 (electronic), 1995/96.
- [21] Jean-Michel Coron. On the controllability of 2-D incompressible perfect fluids. *J. Math. Pures Appl. (9)*, 75(2):155–188, 1996.
- [22] Jean-Michel Coron. Local controllability of a 1-D tank containing a fluid modeled by the shallow water equations. *ESAIM Control Optim. Calc. Var.*, 8:513–554, 2002. A tribute to J. L. Lions.

- [23] Jean-Michel Coron. *Control and nonlinearity*, volume 136 of *Mathematical Surveys and Monographs*. American Mathematical Society, Providence, RI, 2007.
- [24] Jean-Michel Coron and Emmanuelle Crépeau. Exact boundary controllability of a nonlinear KdV equation with critical lengths. *J. Eur. Math. Soc. (JEMS)*, 6(3):367–398, 2004.
- [25] Jean-Michel Coron and Andrei V. Fursikov. Global exact controllability of the 2D Navier-Stokes equations on a manifold without boundary. *Russian J. Math. Phys.*, 4(4):429–448, 1996.
- [26] Jean-Michel Coron, Olivier Glass, and Zhiqiang Wang. Exact boundary controllability for 1-d quasilinear hyperbolic systems with a vanishing characteristic speed. *SIAM J. Control Optim.*, 48(5):3105–3122, 2009.
- [27] Jean-Michel Coron and Sergio Guerrero. Local null controllability of the two-dimensional Navier-Stokes system in the torus with a control force having a vanishing component. *J. Math. Pures Appl. (9)*, 92(5):528–545, 2009.
- [28] Jean-Michel Coron and Emmanuel Trélat. Global steady-state controllability of one-dimensional semilinear heat equations. *SIAM J. Control Optim.*, 43(2):549–569 (electronic), 2004.
- [29] Lokenath Debnath. *Nonlinear water waves*. Academic Press Inc., Boston, MA, 1994.
- [30] François Dubois, Nicolas Petit, and Pierre Rouchon. Motion planning and nonlinear simulations for a tank containing a fluid. In *European Control Conference (Karlsruhe, Germany, September 1999)*, 1999.
- [31] Caroline Fabre, Jean-Pierre Puel, and Enrique Zuazua. Approximate controllability of the semilinear heat equation. *Proc. Roy. Soc. Edinburgh Sect. A*, 125(1):31–61, 1995.
- [32] Enrique Fernández-Cara, Sergio Guerrero, Oleg Yu. Imanuvilov, and Jean-Pierre Puel. Local exact controllability of the Navier-Stokes system. *J. Math. Pures Appl. (9)*, 83(12):1501–1542, 2004.
- [33] Enrique Fernández-Cara and Enrique Zuazua. Null and approximate controllability for weakly blowing up semilinear heat equations. *Ann. Inst. H. Poincaré Anal. Non Linéaire*, 17(5):583–616, 2000.
- [34] Halina Frankowska. An open mapping principle for set-valued maps. *J. Math. Anal. Appl.*, 127(1):172–180, 1987.
- [35] Andrei V. Fursikov and Oleg Yu. Imanuvilov. On exact boundary zero-controllability of two-dimensional Navier-Stokes equations. *Acta Appl. Math.*, 37(1-2):67–76, 1994.
- [36] Andrei V. Fursikov and Oleg Yu. Imanuvilov. *Controllability of evolution equations*, volume 34 of *Lecture Notes Series*. Seoul National University Research Institute of Mathematics Global Analysis Research Center, Seoul, 1996.
- [37] Andrei V. Fursikov and Oleg Yu. Imanuvilov. Local exact controllability of the Navier-Stokes equations. *C. R. Acad. Sci. Paris Sér. I Math.*, 323(3):275–280, 1996.
- [38] Andrei V. Fursikov and Oleg Yu. Imanuvilov. Local exact controllability of two-dimensional Navier-Stokes equations. *Sbornik Math.*, 187(9):1355–1390, 1996.

- [39] Andrei V. Fursikov and Oleg Yu. Imanuvilov. Exact controllability of the Navier-Stokes and Boussinesq equations. *Russian Math. Surveys*, 54:565–618, 1999.
- [40] Andrei Gabrielov. Multiplicity of a zero of an analytic function on a trajectory of a vector field. In *The Arnoldfest (Toronto, ON, 1997)*, volume 24 of *Fields Inst. Commun.*, pages 191–200. Amer. Math. Soc., Providence, RI, 1999.
- [41] Andrei Gabrielov, Frédéric Jean, and Jean-Jacques Risler. Multiplicity of polynomials on trajectories of polynomial vector fields in \mathbf{C}^3 . In *Singularities Symposium—Lojasiewicz 70 (Kraków, 1996; Warsaw, 1996)*, volume 44 of *Banach Center Publ.*, pages 109–121. Polish Acad. Sci., Warsaw, 1998.
- [42] Olivier Glass. Contrôlabilité exacte frontière de l'équation d'Euler des fluides parfaits incompressibles en dimension 3. *C. R. Acad. Sci. Paris Sér. I Math.*, 325(9):987–992, 1997.
- [43] Olivier Glass. Exact boundary controllability of 3-D Euler equation. *ESAIM Control Optim. Calc. Var.*, 5:1–44 (electronic), 2000.
- [44] Olivier Glass. On the controllability of the Vlasov-Poisson system. *J. Differential Equations*, 195(2):332–379, 2003.
- [45] Olivier Glass. On the controllability of the 1-D isentropic Euler equation. *J. Eur. Math. Soc. (JEMS)*, 9(3):427–486, 2007.
- [46] Robert Hermann. On the accessibility problem in control theory. In *Internat. Sympos. Nonlinear Differential Equations and Nonlinear Mechanics*, pages 325–332. Academic Press, New York, 1963.
- [47] Lop Fat Ho. Observabilité frontière de l'équation des ondes. *C. R. Acad. Sci. Paris Sér. I Math.*, 302(12):443–446, 1986.
- [48] Thierry Horsin. On the controllability of the Burgers equation. *ESAIM Control Optim. Calc. Var.*, 3:83–95 (electronic), 1998.
- [49] Oleg Yu. Imanuvilov. Boundary controllability of parabolic equations. *Uspekhi Mat. Nauk*, 48(3(291)):211–212, 1993.
- [50] Oleg Yu. Imanuvilov. Controllability of parabolic equations. *Mat. Sb.*, 186(6):109–132, 1995.
- [51] Oleg Yu. Imanuvilov. On exact controllability for the Navier-Stokes equations. *ESAIM Control Optim. Calc. Var.*, 3:97–131 (electronic), 1998.
- [52] Oleg Yu. Imanuvilov. Remarks on exact controllability for the Navier-Stokes equations. *ESAIM Control Optim. Calc. Var.*, 6:39–72 (electronic), 2001.
- [53] Oleg Yu. Imanuvilov and Jean-Pierre Puel. On global controllability of 2-D Burgers equation. *Discrete Contin. Dyn. Syst.*, 23(1-2):299–313, 2009.
- [54] Matthias Kawski. High-order small-time local controllability. In H.J. Sussmann, editor, *Nonlinear controllability and optimal control*, volume 133 of *Monogr. Textbooks Pure Appl. Math.*, pages 431–467. Dekker, New York, 1990.
- [55] Irena Lasiecka and Roberto Triggiani. Exact controllability of semilinear abstract systems with application to waves and plates boundary control problems. *Appl. Math. Optim.*, 23(2):109–154, 1991.
- [56] Gilles Lebeau and Luc Robbiano. Contrôle exact de l'équation de la chaleur. *Comm. Partial Differential Equations*, 20(1-2):335–356, 1995.

- [57] Ta-tsien Li. *Controllability and Observability for Quasilinear Hyperbolic Systems*, volume 3 of *AIMS Series on Applied Mathematics*. American Institute of Mathematical Sciences (AIMS), Springfield, MO, 2010.
- [58] Jacques-Louis Lions. *Contrôlabilité exacte, perturbations et stabilisation de systèmes distribués. Tome 1*, volume 8 of *Recherches en Mathématiques Appliquées*. With appendices by E. Zuazua, C. Bardos, G. Lebeau and J. Rauch.
- [59] Jacques-Louis Lions. Exact controllability, stabilization and perturbations for distributed systems. *SIAM Rev.*, 30(1):1–68, 1988.
- [60] Jacques-Louis Lions. Exact controllability for distributed systems. Some trends and some problems. In *Applied and industrial mathematics (Venice, 1989)*, volume 56 of *Math. Appl.*, pages 59–84. Kluwer Acad. Publ., Dordrecht, 1991.
- [61] Jacques-Louis Lions. Are there connections between turbulence and controllability? *9th INRIA International Conference, Antibes*, June 12–15, 1990.
- [62] Tadashi Nagano. Linear differential systems with singularities and an application to transitive Lie algebras. *J. Math. Soc. Japan*, 18:398–404, 1966.
- [63] Petr K. Rashevski. About connecting two points of complete nonholonomic space by admissible curve. *Uch Zapiski Ped. Inst. Libknexta*, 2:83–94, 1938.
- [64] Jean-Jacques Risler. A bound for the degree of nonholonomy in the plane. *Theoret. Comput. Sci.*, 157(1):129–136, 1996.
- [65] Lionel Rosier. Exact boundary controllability for the Korteweg-de Vries equation on a bounded domain. *ESAIM Control Optim. Calc. Var.*, 2:33–55 (electronic), 1997.
- [66] Pierre Rouchon. Control of a quantum particle in a moving potential well. In *Lagrangian and Hamiltonian methods for nonlinear control 2003*, pages 287–290. IFAC, Laxenburg, 2003.
- [67] David L. Russell. Nonharmonic Fourier series in the control theory of distributed parameter systems. *J. Math. Anal. Appl.*, 18:542–560, 1967.
- [68] Armen Shirikyan. Approximate controllability of three-dimensional Navier-Stokes equations. *Comm. Math. Phys.*, 266(1):123–151, 2006.
- [69] Leonard M. Silverman and Henry E. Meadows. Controllability and time-variable unilateral networks. *IEEE Trans. Circuit Theory*, CT-12:308–314, 1965.
- [70] Eduardo D. Sontag. Finite-dimensional open-loop control generators for nonlinear systems. *Internat. J. Control*, 47(2):537–556, 1988.
- [71] Eduardo D. Sontag. Control of systems without drift via generic loops. *IEEE Trans. Automat. Control*, 40(7):1210–1219, 1995.
- [72] Gianna Stefani. On the local controllability of a scalar-input control system. In C.I. Byrns and A. Lindquist, editors, *Theory and applications of nonlinear control systems (Stockholm, 1985)*, pages 167–179. North-Holland, Amsterdam, 1986.
- [73] Héctor J. Sussmann. Orbits of families of vector fields and integrability of distributions. *Trans. Amer. Math. Soc.*, 180:171–188, 1973.
- [74] Héctor J. Sussmann. Lie brackets and local controllability: a sufficient condition for scalar-input systems. *SIAM J. Control Optim.*, 21(5):686–713, 1983.

-
- [75] Héctor J. Sussmann. A general theorem on local controllability. *SIAM J. Control Optim.*, 25(1):158–194, 1987.
- [76] Héctor J. Sussmann and Wensheng Liu. Motion planning and approximate tracking for controllable systems without drift. In *Proceedings of the 25th Annual Conference on Information Sciences and Systems (Johns Hopkins University, USA, 1991)*, pages 547–551, 1991.
- [77] Alexander I. Tret'yak. Necessary conditions for optimality of odd order in a time-optimality problem for systems that are linear with respect to control. *Mat. Sb.*, 181(5):625–641, 1990.
- [78] Xu Zhang. A unified controllability/observability theory for some stochastic and deterministic partial differential equations. In *Proceedings of the International Congress of Mathematicians Hyderabad, India, 2010*.
- [79] Enrique Zuazua. Exact boundary controllability for the semilinear wave equation. In Haïm Brezis and Jacques-Louis Lions, editors, *Nonlinear partial differential equations and their applications. Collège de France Seminar, Vol. X (Paris, 1987–1988)*, volume 220 of *Pitman Res. Notes Math. Ser.*, pages 357–391. Longman Sci. Tech., Harlow, 1991.
- [80] Enrique Zuazua. Exact controllability for semilinear wave equations in one space dimension. *Ann. Inst. H. Poincaré Anal. Non Linéaire*, 10(1):109–129, 1993.

Probabilistically Checkable Proofs and Codes

Irit Dinur*

Abstract

NP is the complexity class of problems for which it is easy to check that a solution is correct. In contrast, finding solutions to certain **NP** problems is widely believed to be hard. The canonical example is the SAT problem: given a Boolean formula, it is notoriously difficult to come up with a satisfying assignment, whereas given a proposed assignment it is trivial to plug in the values and verify its correctness. Such an assignment is an “**NP**-proof” for the satisfiability of the formula.

Although the verification is simple, it is not *local*, i.e., a verifier must typically read (almost) the entire proof in order to reach the right decision. In contrast, the landmark PCP theorem [4, 3] says that proofs can be encoded into a special “PCP” format, that allows speedy verification. In the new format it is guaranteed that a PCP proof of a false statement will have many many errors. Thus such proofs can be verified by a randomized procedure that is *local*: it reads only a *constant* (!) number of bits from the proof and with high probability detects an error if one exists.

How are these PCP encodings constructed? First, we describe the related and possibly cleaner problem of constructing *locally testable codes*. These are essentially error correcting codes that are testable by a randomized local algorithm. We point out some connections between local testing and questions about stability of various mathematical systems. We then sketch two known ways of constructing PCPs.

Mathematics Subject Classification (2010). 68Q17, 68Q15

Keywords. Probabilistically Checkable Proofs, PCP, Locally Testable Codes.

*The Weizmann Institute of Science Rehovot, 76100 ISRAEL.
E-mail: irit.dinur@weizmann.ac.il

1. Introduction

In this paper we discuss the computational complexity class **NP** and a robust characterization of this class through Probabilistically Checkable Proofs (PCPs). We describe the

NP is the complexity class of problems for which it is easy to check that a solution is correct. In contrast, finding solutions to **NP** problems is widely believed to be hard. Consider for example the problem 3-SAT¹. Given a 3-CNF Boolean formula, it is notoriously difficult to come up with a satisfying assignment, whereas given a proposed assignment it is trivial to plug in the values and verify its correctness. Such an assignment is an “**NP**-proof” for the satisfiability of the formula. Indeed, an alternative way to define **NP** is as the class of all sets $L \subset \{0,1\}^*$ that have efficient proof systems: proof systems in which there is a polynomial-time algorithm that verifies correctness of the statement $x \in L$ with assistance of a proof. This significantly generalizes systems such as Frege’s propositional calculus in which a proof system is defined by a set of axioms and inference rules, and a valid proof consists of a sequence of steps that are either axioms or inferred from previous steps through an inference rule.

Intuitively, a proof is very sensitive to error. A false theorem can be “proven” by a proof that consists of only one erroneous step. Similarly, a 3-SAT formula φ can be unsatisfiable, yet have an assignment that satisfies all clauses save one. In these cases, the verifier must check *every single proof step / clause* in order to make sure that the proof is correct.

Probabilistically Checkable Proofs. In contrast, the PCP theorem gives each set in **NP** an alternative proof system, in which proofs are robust. In this system a proof for a false statement is guaranteed to have so many errors that a verifier can randomly read only a few bits from the proof and decide, with high probability of success, whether the proof is valid or not.

More formally, a PCP verifier for a set $L \in \mathbf{NP}$ is an extension of the standard NP verifier. Whereas the standard verifier is given an input $x \stackrel{?}{\in} L$ and access to a proof π and is required to accept or reject, the PCP verifier is also allowed to read some r random bits. However, it is restricted to read only at most q bits from the proof. The class $PCP[r, q]$ is defined to contain all languages L for which there is a verifier V that uses $O(r)$ random bits, reads $O(q)$ bits from the proof, and guarantees the following. Let $V^\pi(x, \rho)$ denote the output of V on input x , randomness ρ , and proof π .

- (Completeness:) If $x \in L$ then there is a proof π such that

$$\Pr_{\rho}[V^{\pi}(x, \rho) \text{ accepts}] = 1.$$

¹3-SAT is defined in Section 2.

- (Soundness:) If $x \notin L$ then for any proof π ,

$$\Pr_{\rho}[V^{\pi}(x, \rho) \text{ accepts}] \leq \frac{1}{2}.$$

The PCP theorem says that every $L \in \mathbf{NP}$ has a verifier that uses at most $O(\log n)$ random bits and reads only $O(1)$ bits from the proof. In other words,

Theorem 1.1 (PCP Theorem, [4, 3]). $\mathbf{NP} \subseteq \text{PCP}[\log n, 1]$.

Consider, as an example, the PCP verifier for 3-SAT. Given an instance, i.e. a 3-CNF Boolean formula φ , the PCP verifier reads φ , but is only allowed access to a *constant* q number of bits from a proof string π . What should be written in these bits? This clearly cannot be the “obvious” proof which is just an assignment to the variables of φ . Such a proof will miserably fail the soundness condition: unsatisfiable formulae that can be almost satisfied will fool the verifier into accepting with too high a probability.

Locally Testable Codes. The fact that in a PCP proof system, a proof for a false statement is guaranteed to have many errors begs the analogy to error correcting codes. An error correcting code is a mapping $C : \{0, 1\}^k \rightarrow \{0, 1\}^n$ in which even a tiny distance between two message strings $x \neq y \in \{0, 1\}^k$ is guaranteed to become huge: the encoded strings $C(x), C(y)$ will differ on at least (say) 20% of their bits. In this analogy, it is the number of erroneous steps in a proof that needs to be greatly amplified.

Can a PCP proof be constructed simply by encoding the standard NP proof? This seems like a promising path to follow since error correcting codes are easy to come by. In fact, the answer is yes, but with a caveat. A simple error correcting code will certainly not do the trick. The encoding must be much more subtle, and the main additional ingredient that is needed is *local testability*. Local testability is the ability to decide if a string is a valid codeword by looking at a (randomly selected) small part of it. This leads us to the definition of *locally testable codes (LTCs)* whose construction is the combinatorial heart of constructing PCPs. LTCs are a clean mathematical analog of PCPs whose definition is direct and requires no mention of computation. We will discuss testability and LTCs in Section 4.

Stability. Local testability is related to the notion of stability of mathematical systems. Generally speaking, a system of constraints (e.g. equations) is considered stable if small perturbations of the system result in small perturbations of the solution set. In such systems the only way to approximately satisfy the system is by taking a valid solution and perturbing it. In other words, approximate solutions are always perturbations of exact solutions.

In the discrete setting, when the constraints are, for example, Boolean, a system of constraints is *stable* if any approximate solution, i.e. one that satisfies

many of the constraints, must be close to a perfect solution, i.e. one that satisfies the entire system. This notion naturally appears in various other mathematical contexts, and there are interesting connections between results on PCPs and stability results in areas such as discrete Fourier analysis, geometry, probability, and arithmetic combinatorics.

Stability and hardness of approximation. The PCP machinery allows one to transform any system (that belongs to **NP**) into a stable system. The transformation can be done efficiently, even if solving the system is infeasible. For example, the following is equivalent to the PCP theorem:

Theorem 1.2 (Informal Statement). *There is an efficiently computable transformation r_{PCP} that on input a 3-CNF formula φ generates a 3-CNF formula $\varphi' = r_{\text{PCP}}(\varphi)$ such that the set $s(\varphi') = \{x \mid x \text{ satisfies } \varphi'\}$ is stable (i.e., whenever x' satisfies many of the clauses of φ' it must be close to some $x \in s(\varphi')$).*

Feige et. al. [16] were the first to discover the equivalence of this theorem and Theorem 1.1, and this has had far reaching implications for the complexity of approximation problems. We will discuss this further in Section 3.2.

Let us point out that Theorem 1.2 implies that if $\mathbf{P} \neq \mathbf{NP}$ there is no algorithm that inputs a 3-CNF formula and approximates the maximal number of satisfiable clauses to within increasingly better precision. The reason is that by applying such an algorithm on $r_{\text{PCP}}(\varphi)$ one can determine if φ is satisfiable or not, thus solving an **NP**-complete problem.

In other words, we have just established the hardness of finding, even approximately, the maximal number of satisfiable clauses in a 3-SAT formula.

Gap amplification. The key to constructing PCPs is a transformation that amplifies errors in a proof, had there been any in the first place. The original proof and formulation of the PCP theorem stemmed out of research on proof verification. The techniques used in the proof are largely based on algebraic encodings and testing results that are generally called “low degree tests”. More recently, a combinatorial proof was given by the author [13]. This proof is described more naturally as a hardness of approximation result, and it relies on rapid mixing of random walks on expanding graphs. In Section 5 we sketch these two approaches.

Organization. We begin in Section 2 with basic definitions, as well as an introduction of the class **NP** aimed at the non-experts. In Section 3 we formally state the PCP theorem, and connect it to hardness of approximation problems. In Section 4 we discuss stability and local testable codes, and give a concrete example of a locally testable code. This is intended to provide some intuition as to how PCPs work. Finally, in Section 5 we sketch the algebraic and combinatorial constructions of PCPs.

2. Preliminaries

2.1. Computational Problems. A computational (search) problem is formally described by a relation $S \subset \{0, 1\}^* \times \{0, 1\}^*$. We interpret the pair $(x, y) \in S$ to mean that y is a valid solution for problem instance x . Some examples are

- **SATISFY** = $\{(\varphi, a)\}$ where φ describes a Boolean logic formula; and a describes a satisfying assignment to the variables (i.e., an assignment under which the formula evaluates to true).
- **CLIQUE** = $\{(G, K)\}$ where G describes a graph, and K describes a clique in the graph, i.e. a set of vertices each pair of which are connected by an edge.
- **PROOFS** = $\{(T, \pi)\}$ where T describes a theorem in some fixed logic proof system, and π describes a proof for T in that proof system.

An optimization problem is a search problem S together with a valuation function $v : \{0, 1\}^* \rightarrow \mathbb{R}^+$ that assigns a value to each solution. For example the maximum clique problem is the search problem **CLIQUE** together with a valuation function that counts the number of vertices in a given solution. The goal is to find a clique of largest size.

An algorithm is called *efficient* if its running time is bounded by a polynomial function in the length of the input. Whenever we consider an algorithm it is implicitly assumed to be efficient. An algorithm solves an optimization (maximization or minimization) problem if for every instance $x \in \{0, 1\}^*$ it finds a $y \in \{0, 1\}^*$ such that $(x, y) \in S$ (if one exists) and $v(y)$ is optimal (maximal or minimal).

An *r-approximation* algorithm for a given combinatorial optimization problem is an algorithm that always finds a solution whose value is within multiplicative factor r of the optimal value.

It is often simpler to work with decision problems. A decision problem, or a language, is a set $L \subset \{0, 1\}^*$. For a search problem S , denote by $S(x) = \{y \mid (x, y) \in S\}$. A set L is called a *decision version* of a search problem S if

$$L = \{x \in \{0, 1\}^* \mid S(x) \neq \phi\}$$

2.2. The class NP. It is natural to restrict attention to search problems in which a correct solution can be efficiently recognized, regardless of how it is reached.

Definition 1. An **NP** search problem is a search problem S for which there is an efficient algorithm that inputs an instance x and a purported solution for it y such that $|y| \leq |x|^{O(1)}$ and outputs ‘yes’ if and only if $(x, y) \in S$.

Definition 2 (The Class NP). The class **NP** is the set of languages $L \subseteq \{0, 1\}^*$ that are decision versions of **NP** search problems.

A canonical example of a language in **NP** is Satisfiability (SAT). It consists of all satisfiable formulae φ . The corresponding search problem, described earlier as SATISFY, consists of all pairs (φ, a) where φ describes a logical Boolean formula, and a describes an assignment to the variables that satisfies the formula. Clearly, one can efficiently verify that a is a valid solution simply by plugging in the values and simplifying. Intuitively, this seems much easier to do than to actually find a from scratch. Indeed, an equivalent way to state the famous $\mathbf{P} \neq \mathbf{NP}$ conjecture is to say that there is no efficient way to always find a given φ .

We next describe an optimization problem called max-CSP, which is **NP**-complete. First, let us define a constraint.

Definition 3 (Constraint). Let $V = \{v_1, \dots, v_n\}$ be a set of variables that take values in some finite alphabet Σ . A q -ary constraint $C = (\psi, i_1, \dots, i_q)$ consists of a q -tuple of indices $i_1, \dots, i_q \in [n]$ and a predicate $\psi : \Sigma^q \rightarrow \{0, 1\}$. A constraint is *satisfied* by a given assignment $a : V \rightarrow \Sigma$ iff $\psi(a(v_{i_1}), a(v_{i_2}), \dots, a(v_{i_q})) = 1$.

The CSP problem with parameters q and $|\Sigma|$ is defined as follows. The problem instance is a set V of variables, an alphabet Σ , and a set of constraints C_1, \dots, C_m . The goal is to find an assignment to the variables that satisfies all of the constraints. Several well-known problems in **NP** are special cases of CSP. For example,

- 3-SAT is the problem when $\Sigma = \{0, 1\}$, all constraints have $q = 3$ and a predicate that can be written as a disjunction of three literals, e.g. $\psi(a, b, c) = a \vee \neg b \vee c$.
- 3-COL is usually defined as a problem on graphs: given a graph, find a 3 coloring of the vertices $\chi : V \rightarrow \{1, 2, 3\}$ such that no two adjacent vertices are colored by the same color. Clearly, this is a special case of CSP if we take variable for each vertex, $q = 2$, $\Sigma = \{1, 2, 3\}$, and let each edge represent a constraint whose predicate is the unequal predicate $\psi(a, b) = 1$ iff $a \neq b$.
- 3-LIN is the CSP problem when $\Sigma = \{0, 1\}$, all constraints have $q = 3$ and all predicates are affine equations over the field $GF(2)$.

The related optimization problem max-CSP is the problem of finding an assignment that maximizes the number of satisfied constraints.

2.3. NP and Efficient Proof Systems. An equivalent definition of the class **NP**, is as a class of efficient proof systems. Roughly speaking, a logic proof system consists of a set of axioms and inference rules, such that any of its theorems can be obtained through a sequence of steps each of which is either an axiom, or is inferred from previous steps through application of

one of the inference rules. As an example, one should keep in mind Frege's propositional calculus (see [11]) which consists of six axioms and one inference rule. A proof system has two important properties called *completeness* and *soundness*. Completeness means that every provable statement is true, and soundness means that every true statement has a proof.

One can generalize this notion of a proof system as follows. First, observe that one can fully describe the proof system through its verification process, which we will call its *verifier* from now on. The verifier is nothing but an algorithm that checks that each step is either an axiom or a result of applying a derivation rule on some previous steps. Now, since the verifier fully defines the proof system, we generalize by allowing a wider class of verifiers. Indeed, we allow the verifier to be *any* efficient algorithm. We insist on the efficiency of the verifier to maintain the intuitive notion that checking a proof should be an easy and technical matter, unlike, perhaps, coming up with one.

More formally,

Definition 4. A language $L \subset \{0,1\}^*$, has an *efficient proof system* if there is an efficient algorithm, called a verifier, that inputs a string x and also a purported proof string y . The verifier runs in time polynomial in $|x|$ and either accepts or rejects, and

- (Completeness:) If $x \in L$ then there is some y that the verifier accepts. (In other words for every $x \in L$ there is an acceptable proof y).
- (Soundness:) If $x \notin L$ then for every y the verifier rejects. (In other words, no proof y will be able to prove a false statement).

In this proof system the set L is interpreted to be the set of all 'theorems', or 'true' statements.

Definition 5 (The class **NP**, second definition). The class **NP** is the set of all languages L that have efficient proof systems.

For example, the set SAT of all logical Boolean formulae that are satisfiable has an efficient proof system. The verifier is a simple algorithm that expects, as proof, a string y that represents a satisfying assignment, and then plugs it in the formula and simplifies. From this example it becomes clear that **NP** provides a rich variety of proof systems, quite different from the sequential ones with which we began our discussion.

Reductions and NP completeness One can move quite freely between different **NP** languages through *reductions*. A reduction from L_1 to L_2 is a mapping $r : \{0,1\}^* \rightarrow \{0,1\}^*$ that has two properties. First, it is computable in polynomial time, and second, it guarantees that $x \in L_1$ if and only if $r(x) \in L_2$. There are languages in **NP**, called **NP-complete**, that are "hardest" in the sense that any other **NP** language can be reduced to them. SAT is a canonical example

for an **NP**-complete set, and there are many others. The **NP**-completeness of SAT implies that for every $L \in \mathbf{NP}$ there is a reduction r mapping it to SAT.

Through the notion of reductions we can see that one set can have many different NP verifiers (or proof systems). For example, let L denote the set of all graphs containing a clique of size at least k , for some k . Since $L \in \mathbf{NP}$ and since SAT is NP-complete, there is a reduction from L to SAT. This gives rise to the following (not so natural) verifier for L : Given an instance $G \in L$, the verifier will first run the reduction to compute the formula $r(G)$, and then check that the proof is a satisfying assignment for this formula.

This example demonstrates that one **NP** set can have many proof systems, quite different from one another. We will see in Section 3 that some of these proof systems turn out to have quite remarkable properties.

2.4. Error Correcting Codes. The *Hamming* distance of a pair of strings $x, y \in \{0, 1\}^n$ is denoted $\text{Dist}(x, y)$ and is the number of bits on which they differ. The relative Hamming distance is denoted by $\text{dist}(x, y)$ and is equal to $\text{Dist}(x, y)/n$.

We define an error correcting code with relative distance δ to be a mapping $C : \{0, 1\}^k \rightarrow \{0, 1\}^n$ for which the following holds:

$$\forall x \neq y \in \{0, 1\}^k, \quad \text{dist}(C(x), C(y)) \geq \delta.$$

We usually think of an error correcting code as part of an asymptotic family of codes C_k one for each message length k , but this will be suppressed from the following discussion.

Let us remark that error correcting codes with constant relative distance are not hard to come by. A $GF(2)$ -linear mapping $C : \{0, 1\}^k \rightarrow \{0, 1\}^n$ with $n = \Theta(k)$ that is defined by an $n \times k$ matrix with 0/1 entries selected independently at random will have constant relative distance with overwhelming probability.

3. The PCP Theorem

Probabilistically Checkable Proofs (PCPs) have evolved from the celebrated notion of interactive proofs [23, 5] and the complexity class IP. This line of research was originally motivated by cryptography and the study of what it means for two entities to prove something to one another. Soon it led to a list of remarkable complexity-theoretic results (e.g., see [30, 40, 9, 17, 7]), which seemed to suggest existence of a PCP verifier for every language in **NP**. At the same time, a surprising connection was discovered by [16], showing that existence of such a PCP verifier would imply that it is NP-hard to determine the size of the maximum clique in a graph, *even approximately*. With this additional motivation, the proof was soon found, first partially in [4] and then fully in [3], and came to be known as the PCP theorem (Theorem 1.1).

In this section we present the PCP theorem in two guises. First we follow the standard presentation, as done in the introduction, but in more formal details. Next, we present the PCP theorem as an NP-hardness result about approximating constraint satisfaction problems.

3.1. The PCP theorem - formal statement. The PCP theorem [4, 3] describes, for every language $L \in \mathbf{NP}$, a proof system in which the verifier is both enhanced with additional randomness and restricted in its access to the proof.

Notation For any $n \in \mathbb{N}$ we denote by $[n]$ the set of n elements $\{1, \dots, n\}$. For a string $s \in \{0, 1\}^n$ and a set of indices $I = \{i_1 < \dots < i_t\} \subset [n]$, we denote by $s|_I$ the t -bit string $s_{i_1} s_{i_2} \dots s_{i_t}$ obtained by restricting s to I .

We now define formally the class $PCP[r, q]$ through the notion of an (r, q) -verifier.

Definition 6. An (r, q) -verifier for a language $L \in \mathbf{NP}$ is given an input $x \in \{0, 1\}^n$ and is also allowed to read r random bits. It then computes a set of q indices $I = \{i_1, \dots, i_q\}$ and a Boolean predicate $\psi : \{0, 1\}^q \rightarrow \{0, 1\}$ and accepts if and only if $\psi(\pi|_I) = 1$.

Definition 7. The class $PCP_{c,s}[r, q]$ contains all languages L for which there is an $(O(r), O(q))$ -verifier V such that

- (Completeness:) If $x \in L$ then there is a proof π such that

$$\Pr[\psi(\pi|_I) = 1] \geq c,$$

- (Soundness:) If $x \notin L$ then for any proof π ,

$$\Pr[\psi(\pi|_I) = 1] \leq s.$$

where the probability is over the r bits of randomness of the verifier that are used to compute ψ, I .

The PCP theorem says that every language in NP has a verifier that uses at most $O(\log n)$ random bits and reads only $O(1)$ bits from the proof. Here n denotes the input length and the $O(\cdot)$ notation refers to asymptotic growth of $n \rightarrow \infty$. In other words,

Theorem 3.1 (PCP Theorem, [4, 3]). $\mathbf{NP} \subseteq \mathbf{PCP}_{1, \frac{1}{2}}[O(\log n), O(1)]$.

3.2. The PCP theorem – a hardness of approximation result. The beautiful connection discovered by Feige et. al. [16] shed new light on the hardness of approximating combinatorial optimization problems. (A formal definition of approximation and optimization problems can be found in Section 2). This entire field was soon completely transformed, when many known algorithms found nearly matching lower bounds via the PCP theorem.

Approximation algorithms are a natural way to cope with **NP**-hard problems. By the late 1980's approximation algorithms have been developed for a variety of NP-hard problems. Different problems were found to have approximation algorithms with vastly differing values of the approximation ratio r . Predating the discovery of the PCP theorem and the connection of [16], there were no lower bounds on approximation: it seemed possible that approximation is never NP-hard when $r > 1$, and even that every **NP**-problem can be approximated up to any precision, in polynomial time.

An extreme example is the difference between the approximation behavior of minimum vertex cover² and maximum independent set³. In any graph $G = (V, E)$, if S is an independent set then $V \setminus S$ is a vertex cover. Thus finding an exact solution for one problem is the same as for the other. In contrast, the best approximation for the maximum independent set is within a factor only slightly below the trivial factor of n , whereas vertex cover can be 2-approximated quite easily.

The PCP theorem implied, for the first time, that numerous problems (including, for example, the problems mentioned above) are hard to approximate to within some constant factor. This has had a tremendous impact on the study of combinatorial optimization problems, and today the PCP theorem stands at the heart of nearly all hardness-of-approximation results.

The equivalence between the PCP theorem (as stated in Theorem 3.1) and a hardness of approximation result is easily described in terms of the constraint satisfaction problem CSP (see definition in Section 2). First, let us state a typical hardness of approximation result. We will then prove that it is equivalent to the PCP theorem.

Theorem 3.2. *For every $L \in \mathbf{NP}$ there is an absolute constant $q \in \mathbb{N}$ and a reduction that maps $x \in L$ to a CSP instance with $|\Sigma| = 2$ and q -ary constraints such that if $x \in L$ then there is an assignment satisfying all constraints, and if $x \notin L$ then every assignment satisfies at most $\frac{1}{2}$ of them.*

Proposition 3.3 ([16]). *Theorem 3.1 and Theorem 3.2 are equivalent.*

Proof. (\Rightarrow): Let $L \in \mathbf{NP}$ and let Ver be the (r, q) -verifier for L with $r = O(\log |x|)$ and $q = O(1)$. Recall that for each random string ρ , when Ver is

²In the minimum vertex cover problem, one is given a graph and needs to find a smallest set of vertices that touch all edges.

³In the maximum independent set problem, one is given a graph and needs to find a largest set of vertices that spans no edges.

run on the input x with randomness ρ , it computes a predicate and a set of indices, i.e., a q -ary constraint. The reduction will simulate Ver on every possible random string, thus generating a list of $2^{O(\log n)}$ constraints over variables that represent the proof bits. This is the output CSP instance of the reduction. It is easy to see that the completeness and soundness of Ver translate to the desired behavior of the CSP instance.

(\Leftarrow): Let $L \in \mathbf{NP}$, we design an $(O(\log n), O(1))$ -verifier for it. The verifier will input x , run the reduction computing from x a CSP instance, and then expect the proof π to contain an assignment to the variables of the CSP instance $\mathcal{C} = \{C_1, \dots, C_m\}$. The verifier will use its randomness select a random constraint $C_i = (\psi, i_1, \dots, i_q) \in \mathcal{C}$, read the corresponding bits from the proof and accept iff $\psi(\pi_{\{i_1, \dots, i_q\}}) = 1$. \square

We discuss the proof of this theorem in Section 5.

3.3. Further Results. One way to study the class \mathbf{NP} is by examining its limits, or “boundary”. The search for tightest parameters and parameter tradeoffs of PCP verifiers that still capture \mathbf{NP} has been the focus of research in the past two decades. Some questions of particular interest are

- Suppose the verifier is restricted to make exactly $q \geq 2$ queries. What is the smallest possible probability of error? (this refers to the probability that the verifier accepts an $x \notin L$, or rejects an $x \in L$).
- Viewing a PCP as an encoding of an NP proof, what is the smallest possible encoding length? For example, could there be a mapping that takes an n bit NP proof into an $O(n)$ bit PCP? Currently, the shortest known PCPs take n bit \mathbf{NP} proofs to PCPs of length $n \cdot (\log n)^{O(1)}$.

In terms of inapproximability, similar efforts have been made. Here, one is interested in finding, for each approximation problem, what is the largest r for which it is still \mathbf{NP} -hard⁴ to r -approximate the problem. In several cases this r matches the best known approximation algorithm, and in other cases there is still a huge gap.

The Unique Games Conjecture. One direction that has been very successful in recent years stems from the unique games conjecture of Khot [25]. This conjecture says that a certain restricted type of CSP instance is \mathbf{NP} -hard. This can be viewed as a conjectured “strengthening” of the PCP theorem. There have been many works [28, 27, 14, 29, 12, 39, 35] showing that if this conjecture were true, then various approximation problems would be even harder to approximate, often to within factors that match their best approximation algorithms. Very recently Arora et. al [2] found a slightly subexponential algorithms

⁴A problem is NP-hard if an algorithm for can be used to solve any other problem in \mathbf{NP} .

for unique games. This can be taken as evidence that the unique games CSP may not be **NP** hard, and in the least, it seems easier than other CSP's such as 3-SAT.

4. Local Testing and Stability

The idea that global phenomena can be determined based on local behavior is commonplace. Whether it is astronomers that study the universe through observing a tiny fraction of it, or statisticians deducing about entire populations from polled data. Even when local observations are somewhat noisy we still manage to deduce global properties quite nicely, or at least so we think. In fact, what makes this paradigm go through is the fact that these properties are *stable*.

Generally speaking, a system of constraints (e.g. equations) characterizes a set in a stable manner if any approximate solution to the system is nothing but a perturbation of some exact solution.

A system of constraints over Boolean variables is *stable* if any solution that satisfies many of the constraints must be close to a solution that satisfies the entire system.

In theoretical computer science the focus shifts to the solution set itself rather than the constraints that characterize it. A set that can be characterized by a stable set of local constraints (i.e., where each constraint looks at only at most q bits of the proposed solution) is called *locally testable*.

In what follows we will formally define local testability. Next, we will give an example of a locally testable property. We will then define and discuss locally testable codes, which are an important notion in the construction of PCPs. Finally, we will discuss connections to other mathematical areas in which similar stability phenomena are studied.

4.1. Local Testing. A property of binary strings is a subset $L \subset \{0, 1\}^*$, alternatively described as a sequence $(L_n)_{n \in \mathbb{N}}$, where $L_n \subseteq \{0, 1\}^n$. We next define what a locally testable property is. First let us recall that a constraint over a string $x \in \{0, 1\}^n$ is defined by a predicate $\psi : \{0, 1\}^q \rightarrow \{0, 1\}$ and q indices $i_1, \dots, i_q \in [n]$ and is satisfied on string $x \in \{0, 1\}^n$ if $\psi(x_{i_1}, \dots, x_{i_q}) = 1$.

Definition 8 (Local testability). A property $L_n \subset \{0, 1\}^n$ is locally testable with q queries and error ϵ if there is a set of q -ary constraints C_1, \dots, C_m over n bits such that for every $x \in \{0, 1\}^n$

- If $x \in L$ then $\Pr_{j \in [m]}[x \text{ satisfies } C_j] = 1$
- If $x \notin L$ then $\Pr_{j \in [m]}[x \text{ satisfies } C_j] \leq \epsilon$

A property $(L_n)_{n \in \mathbb{N}}$ is locally testable if L_n is locally testable for every $n \in \mathbb{N}$.

What is it that makes a property testable? Questions regarding what types of properties are locally testable are the topic of a field called *property testing*. This field started out from works on testing low algebraic degree of functions [4, 3, 16, 37, 19, 6, 33] similar to the example below, and more recently has evolved into property testing of graph properties [21], codes [37, 22], and various other types of objects. For a survey, see [20, 36].

4.2. Example: low degree testing. In this section we describe a property that is locally testable. The purpose is to give a sense of what it means to be locally testable. As our example, we chose the linearity testing of [10] which also plays a role in the actual construction of PCPs. We will return to this example later when we describe the PCP construction.

Let our universe consist of all functions $f : \mathbb{F}_2^k \rightarrow \mathbb{F}_2$, where $\mathbb{F}_2 = \{0, 1\}$ is the field with two elements, and $k \in \mathbb{N}$. The property under consideration is the subset of all *linear* functions:

$$\text{LIN} = \left\{ f : \mathbb{F}_2^k \rightarrow \mathbb{F}_2 \mid \exists a_1, \dots, a_k \in \mathbb{F}_2, \text{ s.t. } \forall x \ f(x) = \sum_{i=1}^k a_i x_i \right\}.$$

Although we only defined local testability for properties of strings, Definition 8 easily extends to functions by identifying a function $f : \mathbb{F}_2^k \rightarrow \mathbb{F}_2$ with the string $f \in \{0, 1\}^{2^k}$ that describes its truth table.

In order to show that the property LIN is testable, we must find a set of local constraints that characterize the property in a stable way. This seems easy: for each pair of points $x, y \in \mathbb{F}_2^k$ think of the constraint that is satisfied if and only if

$$f(x) + f(y) = f(x + y).$$

Denoting this constraint by $C_{x,y}$ we define $\mathcal{C} = \{C_{x,y}\}_{x,y \in \mathbb{F}_2^k}$ to be our system of constraints. It remains to verify that the definition of testability holds.

For sanity check we observe that if f is linear then every constraint will be satisfied. Moreover, if every constraint is satisfied then surely the function is linear. What is less obvious is what happens when f satisfies almost all of the constraints, but not quite all. Does it necessarily have to be close to some linear function?. A priori, one could imagine a function g for which

$$\Pr_{x,y \in \mathbb{F}_2^k} [g(x) + g(y) = g(x + y)] > 0.99 \tag{1}$$

and yet g is far from every linear function.

Nevertheless, the linearity testing theorem of [10] implies that any g for which (1) holds must agree with some linear function on at least 99% of the domain.

Theorem 4.1 ([10, 8]). *Let $g : \mathbb{F}_2^k \rightarrow \mathbb{F}_2$ be a function for which $\text{dist}(g, \text{LIN}) \leq \frac{1}{2}$. Then*

$$\Pr_{x,y \in \mathbb{F}_2^k} [g(x) + g(y) \neq g(x + y)] \geq \text{dist}(g, \text{LIN}).$$

The proof of this theorem turns out to be a relatively simple exercise in discrete Fourier analysis. However, even straightforward generalizations of it (for example, for the property of functions having degree 2, 3, etc.) require significantly more work [1, 38, 24, 42] and many open questions still remain.

4.3. Locally testable codes. Let us return to the main topic of this paper, Probabilistically Checkable Proofs. Recall our attempt to construct probabilistically checkable proofs by encoding the **NP** proof. This encoding should amplify errors in the original proof had there been any. The PCP verifier must check that the given proof string is valid, i.e., that it is a valid encoding of a valid **NP** proof. Focusing on the first part of the requirement (i.e., that of being a valid encoding) is the task of locally testing a code.

Definition 9 (Locally testable code). A locally testable code is an error correcting code $C : \{0, 1\}^k \rightarrow \{0, 1\}^n$ whose image $Im(C) = \{C(x) \mid x \in \{0, 1\}^k\}$ is locally testable.

One usually considers error correcting codes with large relative distance, $\delta = \Omega(1)$. In such cases, every bit in the encoding should depend, on average, on a constant fraction of the message bits. In contrast, the fact that $Im(C)$ is locally testable means that there are very local correlations between the encoding bits. These two requirements are in tension with one another, and this is partly what makes the construction of locally testable codes more challenging.

There are few known constructions of LTCs with reasonable parameters. A first example is the Hadamard code

$$H : \{0, 1\}^k \rightarrow \{0, 1\}^{2^k}$$

that encodes a message $a = (a_1, \dots, a_k) \in \{0, 1\}^k$ by a string $H(a) \in \{0, 1\}^{2^k}$ that is the truth table of the linear function f defined by $f(x) = \sum_{i=1}^k a_i x_i$. First, note that if $a \neq b \in \{0, 1\}^k$ then $\text{dist}(H(a), H(b)) = \frac{1}{2}$, so this code has good relative distance. Next, note that H is locally testable. This follows from the testability of the property LIN described in the previous section.

The main drawback of the Hadamard code as an LTC is its encoding length, encoding k bits by 2^k . There are much more efficient constructions, yet they are much more complicated and less ‘explicit’. In general these come by stripping down a construction of an equivalent PCP. It is a challenging question to find a construction of an LTC that is as explicit as the Hadamard code, yet with better parameters.

4.4. Connections with other fields. Questions about stability of systems appear in various other fields of mathematics. Below we describe a few examples that have some direct connections with PCPs.

4.4.1. Approximate Polynomials. Polynomial functions obey local constraints that come essentially from interpolation formulae. For example, a degree d univariate polynomial obeys many constraints on $d + 2$ points: simply use the first $d + 1$ points to compute the value on the remaining point, and test that this is indeed the value. That these constraints are also stable is the topic of “low degree tests” which play a key role in the proof of [4, 3] of the PCP theorem.

Similarly a multi-variate polynomial of degree d that must behave in a certain way on subspaces of dimension $d + 1$ (again due to interpolation). The fraction of subspaces on which a function behaves like a polynomial is exactly captured by the so-called Gowers $d + 1$ uniformity norm.

A sequence of works [1, 38, 24, 42] has been focused on characterizing what functions have Gowers uniformity norm that is strictly above the value the norm of a random function. This is called the inverse conjecture for the Gowers uniformity norm, see also [41]. These questions are related to questions in arithmetic combinatorics which study the behavior of sets containing many arithmetic progressions. In PCPs, such results have been used for constructing PCPs with near optimal tradeoff between the number of queries and the error probability [39].

4.4.2. Approximate Dictatorships. Dictatorships are functions $f : \{0, 1\}^n \rightarrow \{0, 1\}$ that depend on only one variable. There are n such basic functions, $\chi_i(x_1, \dots, x_n) = x_i$ for each $i \in [n]$. There are many different ways to characterize dictatorships in the hypercube, and each way leads to a different, and often interesting, stability question. Here are two examples.

- One can measure the *average sensitivity* of a function. This is the probability that $f(x) = f(x + e_i)$ when $x \in \{0, 1\}^n$ and $i \in [n]$ are chosen at random (and e_i is the unit vector with 1 in the i -th coordinate). For balanced functions this value is minimized on dictators. A stability question is to characterize all functions with average sensitivity that is within a constant factor of the minimum. Friedgut [18] proved that such functions must be close to “juntas” which are functions that depend on a constant number of their n variables. Friedgut’s theorem has been used in results related to the hardness of approximating the minimum vertex cover in a graph [15, 28].
- The “majority is stablest” theorem is concerned with the noise sensitivity of Boolean functions. This is the probability that $f(x) = f(y)$ when y is a “noisy” copy of x , i.e. when each coordinate of x is flipped with probability ϵ . Dictatorships are the least sensitive to noise, and the conjecture above says that every function that is “far” from being a dictatorship must have sensitivity at least as much as the majority function does (the majority function evaluates to 1 on inputs x that have more 1’s than 0’s). The “majority is stablest” theorem was conjectured in [27] as part

of an inapproximability result about MAX-CUT. It was later proved in [32] and led to the discovery of a powerful ‘invariance principle’ [32, 31]. At the heart of these results one needs a method to differentiate between dictatorships and between functions that are “smooth” and have no variable that has large influence. The ‘invariance principle’ is a generalization of the central-limit-theorem showing that smooth polynomials behave almost the same regardless of how each individual variable is distributed.

Raghavendra [35] relied on the invariance principle to prove a very general inapproximability result for CSP’s.

We point the reader to Khot’s article [26] for more illuminating examples.

5. Construction of Probabilistically Checkable Proofs

The original proof and formulation of the PCP theorem came from study of proof verification. The techniques are largely based on algebraic encodings and testing results that are generally called “low degree tests”. More recently, a combinatorial proof was given by the author [13]. This proof is framed more naturally as a hardness of approximation result, and it relies on rapid mixing of random walks on expanding graphs. In this section we sketch these two approaches.

5.1. PCPs using algebra. The original proof of the PCP theorem, relies on “algebraic” encodings of **NP** witnesses by low degree functions. This proof proceeds by constructing a $(O(\log n), O(1))$ -verifier for every language in **NP**, thus proving Theorem 3.1.

5.1.1. A verifier for linear CSPs. Before constructing a $(\log n, 1)$ -verifier for every **NP** language, let us construct such a verifier for the CSP language defined by linear and affine predicates. In other words, the input is a set of linear or affine constraints, say each over two variables, and the goal is to verify that a given assignment a satisfies all constraints. This is really only a baby case since a verifier can determine efficiently whether the system is satisfiable without looking at a proof at all. Nevertheless, it gives some intuition for the actual proof.

We can encode the assignment a that satisfies all of these constraints using the so-called *Hadamard* code, that was described in Section 4.3. The PCP verifier would expect as proof the encoding $H(a)$ of an assignment. Since the Hadamard code is a locally testable code, the verifier can test that a purported proof w is a valid encoding of some a . Moreover, it is not hard to see, that since this encoding consists of all linear forms in the input message a , it is also easy to test whether a satisfies some set of affine predicates.

5.1.2. The general case. Moving on to the general case, here are some of the points that are resolved along the way.

- First, we need to be able to encode non-linear predicates. It turns out that it suffices to consider degree 2 predicates since these are already expressive enough to capture **NP** (in other words, the CSP problem with degree 2 predicates is **NP**-complete).
- Our second concern is the exponential length of the Hadamard encoding. The PCP encoding should be efficient. In particular, we cannot afford to encode n bits of message by 2^n bits, as done by the Hadamard code. This again is resolved by considering polynomials of higher degree, say $d = \log n$, over a larger field (of size say $(\log n)^{O(1)}$). In other words, the encoding of an n -bit assignment would be the point evaluation of a polynomial function $p : \mathbb{F}^m \rightarrow \mathbb{F}$ whose restriction to some predefined set of points $S \subset \mathbb{F}^m$ agrees with the original assignment. This brings the length of the encoding down, but causes a new problem. Although “low degree tests” for such functions have been proven, these tests necessarily use at least d queries to test whether a function has degree d . This is no longer constant when $d = \log n$.
- In order to reduce the number of queries from $\log n$ to $O(1)$ one relies on several steps and most importantly, on *composition*. We do not describe this here.
- Finally, we neglected to describe how to check that the encoded proof encodes a *valid* proof, i.e., one that satisfies the original constraints. This is done by additional machinery and in particular using a so-called sum-check procedure. For details see [4, 3].

5.2. PCPs using random walks on graphs. We now describe a combinatorial proof of the PCP theorem due to the author, see [13, 34]. This proof is best described as an inapproximability result, i.e., as a proof for Theorem 3.2, which we quote again for convenience:

Theorem 3.2. *For every $L \in \mathbf{NP}$ there is a $q \in \mathbb{N}$ and a reduction that maps $x \stackrel{?}{\in} L$ to a CSP instance with $|\Sigma| = 2$ and q -ary constraints such that if $x \in L$ then there is an assignment satisfying all constraints, and if $x \notin L$ then every assignment satisfies at most $\frac{1}{2}$ of them.*

It is enough to fix L to be one **NP**-complete language, say 3 – COL. Recall that in this problem the input is a graph $G = (V, E)$ and the goal is to decide whether there is a coloring $c : V \rightarrow \{1, 2, 3\}$ such that for every $(u, v) \in E$, $c(u) \neq c(v)$.

We construct an algorithm that inputs a graph G and outputs a new graph G' such that

- If G is 3 colorable then so is G' .

- If G is not 3 colorable, then every coloring of the vertices of G' must have at least some $\epsilon > 0$ fraction of unsatisfied (i.e., monochromatic) edges.

Let the *unsat* value of a graph G , denoted $\text{unsat}(G)$, be the minimum fraction of monochromatic edges, when going over all possible 3-colorings of G

$$\text{unsat}(G) = \min_{c:V \rightarrow [3]} \left[\Pr_{(u,v) \in E} [c(u) = c(v)] \right].$$

Note that G is 3-colorable if and only if $\text{unsat}(G) = 0$. If G is not 3-colorable then surely $\text{unsat}(G) \geq 1/|E|$.

Our algorithm proceeds by a sequence of encodings,

$$G \rightarrow G_1 \rightarrow G_2 \rightarrow \cdots \rightarrow G'$$

where the *unsat* value is amplified a little in each step.

The basic transformation $G_i \rightarrow G_{i+1}$ will amplify this value by a constant multiplicative factor. This will be done without harming the 3-colorability of G in case it was 3-colorable. In other words, if G_i is 3-colorable, then so is G_{i+1} , but otherwise $\text{unsat}(G_{i+1}) \geq 2 \cdot \text{unsat}(G_i)$ (unless $\text{unsat}(G_i)$ exceeds some constant threshold).

After repeating this basic step $O(\log n)$ times the *unsat* value will become some absolute constant and we are done. The transformation taking G_i to G_{i+1} only causes a linear increase in the size of G , so repeating it this many times ($O(\log n)$) will not cause the output to be too large.

5.2.1. Amplifying the *unsat* value. Let us sketch a description of the transformation taking G_i to G_{i+1} . For notation convenience we denote the input and output graphs of the transformation by G, H instead of G_i, G_{i+1} .

This transformation involves two main steps.

1. In the first step G is encoded by a graph G' and a 3-coloring for G is encoded by a k -coloring for G' , where $k > 3$ is some constant. The vertices of G' are the same as those of G , and the color of a vertex in G' is supposed to encode the colors of all of its neighbors in G . The constraints on the edges of G' are not “inequality” constraints as in a proper k -colorability problem, but rather more general constraints that check that the local colorings are consistent with each other. E.g., if two vertices assign a different color to a common neighbor then this is an inconsistency.

Finally, we place an edge between two vertices in G' if they are at distance up to 100 from each other.

By construction, if G were 3-colorable, then there is a k -coloring that satisfies all of the new constraints. The main thing to prove is the converse. Under some (expansion) conditions on the structure of G , one can show that if the *unsat* value of G was α , the fraction of unsatisfiable constraints on G' is at least 2α .

2. The second step involves an alphabet reduction, taking the k -colorability instance G' back into a 3-colorability instance H without harming the *unsat* value too much. This step relies on composition similarly to the way it is applied in the original proof of the PCP theorem, and is beyond our scope.

Acknowledgements

I wish to thank Adi Akavia, Elazar Goldenberg, Or Meir, Igor Shinkar and Oded Schwartz for helpful comments.

References

- [1] N. Alon, T. Kaufman, M. Krivelevich, S. Litsyn, and D. Ron. Testing Reed-Muller codes. *IEEE Transactions on Information Theory*, 51(11):4032–4039, 2005.
- [2] S. Arora, B. Barak, and D. Steurer. Subexponential algorithms for unique games and related problems. submitted, 2010.
- [3] S. Arora, C. Lund, R. Motwani, M. Sudan, and M. Szegedy. Proof verification and intractability of approximation problems. *Journal of the ACM*, 45(3):501–555, 1998.
- [4] S. Arora and S. Safra. Probabilistic checking of proofs: A new characterization of NP. *Journal of the ACM*, 45(1):70–122, 1998.
- [5] L. Babai. Trading group theory for randomness. In *Proc. 17th ACM Symp. on Theory of Computing*, pages 421–429, 1985.
- [6] L. Babai, L. Fortnow, L. Levin, and M. Szegedy. Checking computations in polylogarithmic time. In *Proc. 23rd ACM Symp. on Theory of Computing*, pages 21–31, 1991.
- [7] L. Babai, L. Fortnow, and C. Lund. Non-deterministic exponential time has two-prover interactive protocols. *Computational Complexity*, 1:3–40, 1991.
- [8] M. Bellare, D. Coppersmith, J. H. Stad, M. Kiwi, and M. Sudan. Linearity testing over characteristic two. *IEEE Transactions on Information Theory*, 42(6):1781–1795, 1996.
- [9] M. Ben-Or, S. Goldwasser, J. Kilian, and A. Wigderson. Multi prover interactive proofs: How to remove intractability assumptions. In *Proc. 20th ACM Symp. on Theory of Computing*, pages 113–131, 1988.
- [10] M. Blum, M. Luby, and R. Rubinfeld. Self-testing/correcting with applications to numerical problems. In *Proc. 22nd ACM Symp. on Theory of Computing*, pages 73–83, 1990.
- [11] S. Buss. An introduction to proof theory. *Handbook of proof theory*, pages 1–78, 1998.

-
- [12] S. Chawla, R. Krauthgamer, R. Kumar, Y. Rabani, and D. Sivakumar. On the hardness of approximating multicut and sparsest-cut. *Computational Complexity*, 15(2):94–114, 2006.
- [13] I. Dinur. The PCP theorem by gap amplification. *Journal of the ACM*, 54(3), 2007.
- [14] I. Dinur, E. Mossel, and O. Regev. Conditional hardness for approximate coloring. *SIAM Journal on Computing*, 39(3):843–873, 2009. Prelim version in STOC 2006.
- [15] I. Dinur and S. Safra. On the hardness of approximating minimum vertex cover. *Annals of Mathematics*, 162(1):439–485, 2005. Preliminary version appeared in STOC 2002.
- [16] U. Feige, S. Goldwasser, L. Lovász, S. Safra, and M. Szegedy. Approximating clique is almost NP-complete. *Journal of the ACM*, 43(2):268–292, 1996.
- [17] L. Fortnow, J. Rompel, and M. Sipser. On the power of multi-prover interactive protocols. *Theoretical Computer Science*, 134(2):545–557, 1994.
- [18] E. Friedgut. Boolean functions with low average sensitivity depend on few coordinates. *Combinatorica*, 18(1):27–35, 1998.
- [19] P. Gemmell, R. Lipton, R. Rubinfeld, M. Sudan, and A. Wigderson. Self-testing/correcting for polynomials and for approximate functions. In *Proc. 23rd ACM Symp. on Theory of Computing*, pages 32–42, 1991.
- [20] O. Goldreich. Introduction to testing graph properties. Manuscript, 2010.
- [21] O. Goldreich, S. Goldwasser, and D. Ron. Property testing and its connection to learning and approximation abstract. *Journal of the ACM*, 45(4):653–750, 1998.
- [22] O. Goldreich and M. Sudan. Locally testable codes and PCPs of almost-linear length. *J. of the ACM*, 53(4):558–655, 2006.
- [23] S. Goldwasser, S. Micali, and C. Rackoff. The knowledge complexity of interactive proofs. *SIAM Journal on Computing*, 18:186–208, 1989.
- [24] B. Green and T. Tao. An inverse theorem for the gowers U3 norm. arXiv:math/0503014v3, 2005.
- [25] S. Khot. On the power of unique 2-prover 1-round games. In *Proceedings of the thirty-fourth annual ACM symposium on Theory of computing*, pages 767–775. ACM Press, 2002.
- [26] S. Khot. Inapproximability of NP-complete problems, discrete fourier analysis, and geometry. 2010.
- [27] S. Khot, G. Kindler, E. Mossel, and R. O’Donnell. Optimal inapproximability results for MAX-CUT and other 2-variable CSPs? *SIAM J. Computing*, 37:319–357, 2007.
- [28] S. Khot and O. Regev. Vertex cover might be hard to approximate to within $2 - \epsilon$. In *Proc. of 18th IEEE Annual Conference on Computational Complexity (CCC)*, pages 379–386, 2003.
- [29] S. Khot and N. Vishnoi. The unique games conjecture, integrality gap for cut problems and embeddability of negative type metrics into ℓ_1 . In *Proc. 46th IEEE Symp. on Foundations of Computer Science*, pages 53–62, 2005.

-
- [30] C. Lund, L. Fortnow, H. Karloff, and N. Nisan. Algebraic methods for interactive proof systems. *Journal of the ACM*, 39(4):859–868, October 1992.
 - [31] E. Mossel. Gaussian bounds for noise correlation of functions. *GAF*, 19:1713–1756, 2010.
 - [32] E. Mossel, R. O’Donnell, and K. Oleszkiewicz. Noise stability of functions with low influences: invariance and optimality. *Ann. Math.*, 171(1):295–341, 2010.
 - [33] A. Polishchuk and D. Spielman. Nearly linear size holographic proofs. In *Proc. 26th ACM Symp. on Theory of Computing*, pages 194–203, 1994.
 - [34] J. Radhakrishnan and M. Sudan. On Dinur’s proof of the PCP theorem. *Bulletin of the AMS*, 44:19–61, 2007.
 - [35] P. Raghavendra. Optimal algorithms and inapproximability results for every CSP? In *Proc. 40th ACM Symp. on Theory of Computing*, pages 245–254, 2008.
 - [36] D. Ron. Property testing (a tutorial). *Handbook on Randomization*, 2, 2001.
 - [37] R. Rubinfeld and M. Sudan. Testing polynomial functions efficiently and over rational domains. In *Proc. 3rd Annual ACM-SIAM Symp. on Discrete Algorithms*, pages 23–32, 1992.
 - [38] A. Samorodnitsky. Low degree tests at large distances. In *Proc. 39th ACM Symp. on Theory of Computing*, 2007.
 - [39] A. Samorodnitsky and L. Trevisan. Gowers uniformity, influence of variables, and PCPs. In *Proc. 38th ACM Symp. on Theory of Computing*, pages 11–20, 2006.
 - [40] A. Shamir. $IP = PSPACE$. *Journal of the ACM*, 39(4):869–877, October 1992. Prelim. version in 1990 FOCS, pages 11–15.
 - [41] T. Tao. The inverse conjecture for the Gowers norm over finite fields via the correspondence principle. Blog post on <http://terrytao.wordpress.com>, 2008.
 - [42] T. Tao and T. Ziegler. The inverse conjecture for the gowers norm over finite fields via the correspondence principle. *Analysis and PDE*. to appear, see arXiv:0810.5527.

Ergodic Structures and Non-conventional Ergodic Theorems

Hillel Furstenberg*

Mathematics Subject Classification (2000). Primary 28D99; Secondary 11B75.

Keywords. arithmetic progression, characteristic factors, distal, dynamical system, ergodic, Gowers seminorm, measure, nilpotent, nilsystem, recurrence, Szemerédi

1. Introduction

Ergodic theory treats measure preserving dynamical systems. We recall: a quadruple $\mathbf{X} = (X, \mathcal{B}, \mu, T)$ is a *measure preserving system* (m.p.s.) if (X, \mathcal{B}, μ) is a measure space with $\mu(X) < \infty$, and $T : X \rightarrow X$ is a measurable, measure preserving map. That is to say, for $B \in \mathcal{B}$, $T^{-1}(B) \in \mathcal{B}$ and $\mu(T^{-1}B) = \mu(B)$. The dynamical character of such a system appears when the transformation T is iterated so that $T^n x$ describes the state at the time n when the initial state is x . There are two theorems at the foundation of classical ergodic theory:

Poincaré's Recurrence Theorem. *If (X, \mathcal{B}, μ, T) is an m.p.s. and $A \in \mathcal{B}$ with $\mu(A) > 0$, then for some $n = 1, 2, 3, \dots$, $\mu(A \cap T^{-n}A) > 0$.*

It is not hard to deduce from this that in fact almost every point of A returns to A infinitely often.

Birkhoff's Pointwise Ergodic Theorem. *If (X, \mathcal{B}, μ, T) is an m.p.s. and $f \in L^1(X, \mathcal{B}, \mu)$, then for almost every $x \in X$, the limit as $N \rightarrow \infty$ of ergodic averages*

$$A_N(f, x) = \frac{1}{N} \sum_{n=0}^{N-1} f(T^n x) \quad (1.1)$$

exists, and the limit function $\bar{f}(x) = \lim A_N(f, x)$ satisfies $\bar{f}(Tx) = \bar{f}(x)$ and $\int \bar{f} d\mu = \int f d\mu$.

*Einstein Institute of Mathematics, The Hebrew University of Jerusalem, Safra Campus Giv'at Ram, Manchester House 202, Jerusalem, 91904, Israel. E-mail: harry@math.huji.ac.il

Our focus here will be on “non-conventional ergodic averages”,

$$\frac{1}{N} \sum_{n=0}^{N-1} f_1(T^{p_1(n)}x) f_2(T^{p_2(n)}x) \cdots f_k(T^{p_k(n)}x) \quad (1.2)$$

and their limits, in which several functions are involved simultaneously, and these are evaluated on the orbit of a point x at polynomial times $p_1(n), p_2(n), \dots, p_k(n)$ respectively. The polynomial character of the times has no special dynamical significance, but is meaningful for diophantine applications.

The diophantine significance of expressions of the form (1.2) showed up first in the ergodic theoretic proof of Szemerédi’s theorem. This theorem states that if a set E of integers has positive upper density, then it contains arbitrarily long arithmetic progressions. It can be shown — via a correspondence principle ([EW10], [TT09, p. 163]) — that this is equivalent to the following extension of the Poincaré recurrence theorem:

The Multiple Recurrence Theorem. *For any m.p.s. $\mathbf{X} = (X, \mathcal{B}, \mu, T)$, if $A \in \mathcal{B}$ with $\mu(A) > 0$ and $k \in \mathbb{N}$, then for some n*

$$\mu(A \cap T^{-n}A \cap T^{-2n}A \cap \cdots \cap T^{-kn}A) > 0. \quad (1.3)$$

This recurrence result was first proved by a consideration of averages. Namely, ([FU77]) one showed that for any k ,

$$\liminf_{N \rightarrow \infty} \frac{1}{N} \sum_{n=0}^{N-1} \mu(A \cap T^{-n}A \cap T^{-2n}A \cap \cdots \cap T^{-kn}A) > 0. \quad (1.4)$$

This raises the question as to whether the limit in question exists, and this will be the case, if, setting $f(x) = 1_A(x)$ the “non-conventional average”

$$\lim_{N \rightarrow \infty} \frac{1}{N} \sum_{n=0}^{N-1} f(T^n x) f(T^{2n} x) \cdots f(T^{kn} x)$$

exists in $L^2(X, \mathcal{B}, \mu)$. This in fact is true but considerably more effort was required to obtain this “mean ergodic theorem” than was needed for (1.4). (See [EW10], [BL96] and [FU81] for a more detailed exposition.)

One is now able to extend the two types of phenomena further to polynomial times, as we’ll see. We can talk of a “polynomial mean ergodic theorem” as well as a “polynomial multiple recurrence theorem”. The former is of interest in its own right as a legitimate topic in ergodic theory; the latter is of interest also for its diophantine and combinatorial implications. The polynomial mean ergodic theorem is the statement that for any bounded measurable functions f_1, f_2, \dots, f_k and integer valued polynomials $p_1(n), p_2(n), \dots, p_k(n)$, the averages in (1.2) converge, as $N \rightarrow \infty$, in $L^2(X, \mathcal{B}, \mu)$. It is believed that

one also has almost everywhere convergence but this has been proved so far only for some special cases. A polynomial multiple recurrence theorem is the analogue of (1.3) or (1.4) with $n, 2n, \dots, kn$ replaced by a suitable set of polynomials. Some restrictions on the polynomials $p_j(n)$ have to be made since, e.g., it is easy to construct systems with $\mu(A \cap T^{-(2n+1)}A) = 0$ for certain A for all n .

2. Ergodicity, Factors and the Basic Structure Theorems

A system (X, \mathcal{B}, μ, T) is *ergodic* if for $A, B \in \mathcal{B}$ with $\mu(A), \mu(B) > 0$ there exists n with $\mu(A \cap T^{-n}B) > 0$. This is equivalent to the condition that if f is measurable and $f \circ T = f$ then f is almost everywhere constant. The ergodic theorem implies in this case that the limit \bar{f} of (1.1) is constant, and the condition $\int f d\mu = \int f d\mu$ implies that $\bar{f}(x) = \frac{1}{\mu(X)} \int f d\mu$. We will be assuming throughout that $\mu(X) = 1$, so that for ergodic systems we obtain $A_N(f, x) \rightarrow \int f d\mu$ a.e.

For two measure spaces (X, \mathcal{B}, μ) and (Y, \mathcal{D}, ν) , a map $\pi : X \rightarrow Y$ is *measurable* if the σ -algebra $\pi^{-1}(\mathcal{D}) \subset \mathcal{B}$ and π is *measure preserving* if for $D \in \mathcal{D}$, $\mu(\pi^{-1}(D)) = \nu(D)$. For (X, \mathcal{B}, μ) a “Lebesgue space” we have the notion of “decomposition of μ relative to (Y, \mathcal{D}, ν) ” and *conditional expectation*. (See [GL03], [FU81] for details). Namely there is an almost everywhere defined map from Y to probability measures on X , $y \rightarrow \mu_y$, so that $\mu = \int \mu_y d\nu(y)$, meaning that $\int f d\mu = \int \{ \int f d\mu_y \} d\nu(y)$ for $f \in L^1(X, \mathcal{B}, \mu)$. The function $\phi(y) = \int f d\mu_y$ is denoted $E(f|\pi^{-1}(\mathcal{D}))$ (See [DO53]). The lift of the latter function to X , $E(f|\pi^{-1}(\mathcal{D})) \circ \pi$ belongs to $L^1(X, \mathcal{B}, \mu)$ and for $f \in L^2(X, \mathcal{B}, \mu)$, the linear map $f \rightarrow E(f|\pi^{-1}(\mathcal{D})) \circ \pi$ is the orthogonal projection of $L^2(X, \mathcal{B}, \mu)$ to the subspace $L^2(Y, \mathcal{D}, \nu) \circ \pi$. We will use the notation $E(f|Y)$ interchangeably for the function $E(f|\pi^{-1}(\mathcal{D}))$ on Y and its lift to X .

For two measure preserving systems $(X, \mathcal{B}, \mu, T), (Y, \mathcal{D}, \nu, S)$ we will speak of a measurable, measure preserving map $\pi : X \rightarrow Y$ as a *homomorphism* if for a.e. $x \in X$, $S\pi(x) = \pi(Tx)$. It will follow that for almost every y , $T(\mu_y) = \mu_{Sy}$ and that $E(f \circ T|Y) = E(f|Y) \circ S$ as functions on Y . When we have a homomorphism of a system \mathbf{X} to a system \mathbf{Y} we speak of the latter as a *factor* of the former and of the former as an *extension* of the latter.

Suppose $\mathbf{Y} = (Y, \mathcal{D}, \nu, S)$ is a *degenerate* system meaning that $Sy = y$ for each $y \in Y$, and suppose $\pi : \mathbf{X} \rightarrow \mathbf{Y}$ is a homomorphism. Then the measures μ_y are T -invariant for a.e. y . We can then form systems $(X, \mathcal{B}, \mu_y, T)$. One now has the *ergodic decomposition theorem*:

Theorem. *For any m.p.s. $\mathbf{X} = (X, \mathcal{B}, \mu, T)$ there is a degenerate factor $\mathbf{Y} = (Y, \mathcal{S}, \nu, S)$ for which the systems $(X, \mathcal{B}, \mu_y, T)$ are almost all ergodic.*

A consequence of this ergodic decomposition theorem, together with the representation $\mu = \int \mu_y d\nu(y)$, is that the issues we are dealing with, recurrence and convergence of ergodic averages, can be confined to the case of an ergodic system. We proceed to present a structure theorem for ergodic systems. We will describe two types of extensions for ergodic systems and the basic structure theorem for ergodic systems will be the assertion that combining these two forms of extensions one can arrive at any ergodic system starting from the trivial 1-point system.

For a compact metric space M we denote by $Isom(M)$ the compact group of isometries of M . We will say that $\mathbf{X} = (X, \mathcal{B}, \mu, T)$ is an *isometric* extension of $\mathbf{Y} = (Y, \mathcal{D}, \nu, S)$ if the former can be represented as $X = Y \times M$ for compact metric M with $\mu = \nu \times m_M$ where $m_M \in \mathcal{P}(M)$ is invariant under isometries, and $T(y, u) = (Sy, \rho(y)u)$ where $\rho : Y \rightarrow Isom(M)$ is measurable. When \mathbf{Y} is a trivial system and \mathbf{X} an ergodic isometric extension, it can be seen that $X \approx M$ is a compact abelian group and $Tx = ax$ where $a \in M$ generates a dense subgroup of M . We call such a system a *Kronecker system* and denote the action of S additively: $z \rightarrow z + \alpha$, and denote the system $(M, \text{Borel sets, Haar measure, translation by } \alpha)$ briefly by (M, α) .

Let $\mathbf{X} = (X, \mathcal{B}, \mu, T)$ be an ergodic m.p.s. with Kronecker factor (Z, α) and let $\varphi : X \rightarrow Z$ define the corresponding homomorphism. Any character $\chi : Z \rightarrow S^1$ satisfies $\chi(z + \alpha) = \chi(\alpha)\chi(z)$ and so lifting to X , if $f = \chi \circ \varphi$, $f(Tx) = \chi \circ \varphi(Tx) = \chi(\varphi(x) + \alpha) = \chi(\alpha)\chi \circ \varphi(x) = \chi(\alpha)f(x)$, we obtain an eigenfunction f of the operator $f \rightarrow f \circ T$. For ergodic systems all eigenfunctions come about in this way, and indeed, using the group of eigenfunctions of the induced operator $Tf = f \circ T$, we can construct a “universal” Kronecker factor $(\tilde{Z}, \tilde{\alpha})$ of \mathbf{X} such that all Kronecker factors of \mathbf{X} are factors of $(\tilde{Z}, \tilde{\alpha})$. We refer to $(\tilde{Z}, \tilde{\alpha})$ as *the* Kronecker factor of \mathbf{X} .

A broader family of systems is obtained by taking successive isometric extensions of previously defined systems. This leads to the notion of a *distal* system: \mathbf{X} is *distal* if it is a member of a (possibly) transfinite tower of systems $\{\mathbf{X}_\eta, \eta \text{ ordinal}\}$ having at its base \mathbf{X}_0 the trivial 1-point system, and with $\mathbf{X}_{\eta+1}$ an isometric extension of \mathbf{X}_η , and for a limit ordinal η , $\mathbf{X}_\eta = \lim_{\xi < \eta} \mathbf{X}_\xi$.

The other type of extension which will appear in our general structure theorem is that of a (relatively) weakly mixing extension, which we abbreviate to WM extension. Recall that a system is (absolutely) weakly mixing if $\mathbf{X} \times \mathbf{X}$ is ergodic. In the relative notion we introduce the “relative product”. If $(X_i, \mathcal{B}_i, \mu_i)$, $i = 1, 2$, are two measure spaces, $f_i, i = 1, 2$, two measurable function on these spaces respectively, we denote by $f_1 \otimes f_2$ the function on $X_1 \times X_2$ with $f_1 \otimes f_2(x_1, x_2) = f_1(x_1)f_2(x_2)$. Suppose \mathbf{X}_1 and \mathbf{X}_2 are both extensions of a system \mathbf{Y} there will be a unique measure $\tilde{\mu}$ on $X_1 \times X_2$ with $\int f_1 \otimes f_2 d\tilde{\mu} = \int E(f_1|Y)E(f_2|Y)d\nu(y)$. If $\mathbf{X}_i = (X_i, \mathcal{B}_i, \mu_i, T_i)$ then $T_1 \times T_2$ will

preserve the measure $\tilde{\mu}$. We can speak of the m.p.s. $(X_1 \times X_2, \mathcal{B}_1 \times \mathcal{B}_2, \tilde{\mu}, T_1 \times T_2)$ which we denote $\mathbf{X}_1 \times_{\mathbf{Y}} \mathbf{X}_2$. We now make the definition:

Definition. A system \mathbf{X} is a *WM extension* of a factor \mathbf{Y} if $\mathbf{X} \times_{\mathbf{Y}} \mathbf{X}$ is ergodic.

Our main structure theorem is:

Theorem. *Every ergodic system is a WM extension of its maximal distal factor.*

It follows from this that every ergodic system arises by taking successively isometric and WM extensions beginning with the trivial system.

The ergodic decomposition theorem together with the foregoing structure theorem were made use of in the original proof of (linear) multiple recurrence in the form (1.4) which implies Szemerédi's theorem. (See [FKO82]). A variant of that argument in the spirit of the proof of Szemerédi's theorem for commuting transformations ([FK78]) is the following. Call a system an MR system when (1.4) holds for all sets A of positive measure and for all k . It is relatively straightforward to show that a WM extension of an MR system is MR. Using van der Waerden's theorem on arithmetic progressions, one can show that the MR property is also preserved under isometric extensions. Finally one argues that every system has a maximal MR factor and this proves that every ergodic system is MR. Ultimately by ergodic decomposition the phenomenon of (linear) multiple recurrence is established.

A similar strategy was adopted by V. Bergelson and A. Leibman in [BL96] to obtain a polynomial multiple recurrence theorem:

Theorem. *Let $p_1(n), p_2(n), \dots, p_k(n)$ be polynomials with integer coefficients and with vanishing constant term ($p_i(0) = 0$), then for any m.p.s. $\mathbf{X} = (X, \mathcal{B}, \mu, T)$ and a set $A \in \mathcal{B}$ with $\mu(A) > 0$, there exists $n \neq 0$ with*

$$\mu(A \cap T^{-p_1(n)} A \cap T^{-p_2(n)} A \cap \dots \cap T^{-p_k(n)} A) > 0$$

The proof in [FK78] of multiple recurrence which is needed for Szemerédi's theorem on arithmetic progressions and its higher dimensional analogues makes use of the related, classical van der Waerden theorem. For the Bergelson-Leibman polynomial version, a polynomial version of van der Waerden's theorem is needed and this too is established in their paper [BL96].

We remark that the formulation in the foregoing theorem is not the final word on multiple recurrence. The result can be refined to include certain sets of polynomials which do not vanish at 0, but this will require additional machinery which will be discussed.

We may make use of the same correspondence principle alluded to earlier to derive the following result regarding "polynomial progressions":

Theorem. *Let $E \subset \mathbb{Z}$ be a subset of positive upper density, and let $p_1(n), p_2(n), \dots, p_k(n)$ be k polynomials vanishing for $n = 0$. Then E contains a progression $\{a, a + p_1(n), a + p_2(n), \dots, a + p_k(n)\}$ with $n \neq 0$.*

3. Characteristic Factors and the van der Corput Lemma

We shall refer to families $\{p_1(n), p_2(n), \dots, p_k(n)\}$ of integer valued polynomials as *schemes*.

Definition. If \mathbf{X} is a m.p.s. and \mathbf{Y} is a factor of \mathbf{X} , we shall say that \mathbf{Y} is a *characteristic factor* for the scheme $\{p_1(n), \dots, p_k(n)\}$ if for every choice of $f_1, f_2, \dots, f_k \in L^\infty(X, \mathcal{B}, \mu)$,

$$\begin{aligned} & \frac{1}{N} \sum_0^{N-1} T^{p_1(n)} f_1 T^{p_2(n)} f_2 \dots T^{p_k(n)} f_k \\ & - \frac{1}{N} \sum_0^{N-1} T^{p_1(n)} E(f_1|Y) T^{p_2(n)} E(f_2|Y) \dots T^{p_k(n)} E(f_k|Y) \rightarrow 0 \end{aligned}$$

in $L^2(X, \mathcal{B}, \mu)$.

Here we have abbreviated $f \circ T$ to Tf . Finding a characteristic factor for a scheme often gives a reduction of the problem of evaluating limit behavior of non-conventional averages to special systems. This will be the case in the proof of the polynomial mean ergodic theorem, which is carried out by first showing the convergence for nilsystems and showing that the latter serve as characteristic factors for all polynomial schemes.

Perhaps the principal tool in identifying characteristic factors is the following lemma which we will refer to as the ‘‘Hilbert space van der Corput lemma’’:

Lemma. *Let \mathcal{H} be a Hilbert space with inner product $\langle \cdot, \cdot \rangle$. Let $\{u_n\}$ be a bounded sequence of vectors in \mathcal{H} and assume that for each m , the limit*

$$\gamma_m = \lim_{N \rightarrow \infty} \frac{1}{N} \sum_{n=1}^N \langle u_n, u_{n+m} \rangle$$

exists. If $\frac{1}{M} \sum_1^M \gamma_m \rightarrow 0$ as $M \rightarrow \infty$, then $\|\frac{1}{N} \sum_1^N u_n\| \rightarrow 0$.

We will illustrate the use of this lemma in showing that for any ergodic system \mathbf{X} , its Kronecker factor (Z, α) is a characteristic factor for the scheme $\{n, 2n\}$. It suffices to show that if $E(f|Z) = 0$ or $E(g|Z) = 0$ then

$$\frac{1}{N} \sum_{n=1}^N T^n f T^{2n} g \rightarrow 0$$

in $L^2(X, \mathcal{B}, \mu)$. Regarding the products $T^n f T^{2n} g$ as elements in $L^2(X, \mathcal{B}, \mu)$, we set $u_n = T^n f T^{2n} g$. Then

$$\langle u_n, u_{n+m} \rangle = \int T^n (f T^m \bar{f}) T^{2n} (g T^{2m} \bar{g}) d\mu = \int f T^m \bar{f} \cdot T^n (g T^{2m} \bar{g}) d\mu$$

By the ergodic theorem the average of these expressions over n exists and by ergodicity

$$\begin{aligned} \gamma_m &= \lim_{N \rightarrow \infty} \frac{1}{N} \sum_{n=1}^N \langle u_n, u_{n+m} \rangle = \int f T^m \bar{f} d\mu \int g T^{2m} \bar{g} d\mu \\ &= \int f \otimes g (T \times T^2)^m \bar{f} \otimes \bar{g} d(\mu \times \mu). \end{aligned}$$

The average over m exists: $\frac{1}{M} \sum_1^M \gamma_m \rightarrow \int f \otimes g H d(\mu \times \mu)$ where $T \times T^2 H = H$. Now invariant functions on a product system are formed from products of eigenfunctions for the individual systems, from which it follows that if either $E(f|Z) = 0$ or $E(g|Z) = 0$, then $\int f \otimes g H d(\mu \times \mu) = 0$. This proves that the Kronecker factor is a characteristic factor for $\{n, 2n\}$ as claimed. We remark that following T. Ziegler [ZI07], for any scheme and any system there exists a “minimal” characteristic factor. If we take into account expressions $\frac{1}{N} \sum_{n=1}^N T^n \varphi^2 T^{2n} \bar{\varphi}$ where φ is an eigenfunction we see that all eigenfunctions of T appear in any characteristic factor for $\{n, 2n\}$. Thus we have identified the minimal characteristic factor for $\{n, 2n\}$ as the Kronecker factor.

One conclusion that can be drawn is the existence of $\lim \frac{1}{N} \sum_{n=1}^N T^n f T^{2n} g$ in $L^2(X, \mathcal{B}, \mu)$ for any system. From the foregoing this is reduced to the special case of a Kronecker system and L^2 -convergence is readily established in this case. Namely, for convergence in L^2 it suffices to consider f, g in an L^4 -dense subset of L^2 , and particularly for f, g continuous. For this case we can use the equidistribution of $\{n\alpha\}$ in Z :

$$\frac{1}{N} \sum_{n=1}^N f(z + n\alpha)g(z + 2n\alpha) \rightarrow \int f(z + \theta)g(z + 2\theta)d\theta$$

which is true pointwise and consequently also in L^2 .

Since strong convergence in $L^2(X, \mathcal{B}, \mu)$ implies weak convergence, we can formulate a consequence of the foregoing:

For $f, g, h \in L^\infty(X, \mathcal{B}, \mu)$,

$$\begin{aligned} \frac{1}{N} \sum \int f(x)g(T^n x)h(T^{2n} x)d\mu &\rightarrow \\ \int E(f|Z)(z)E(g|Z)(z + \theta)E(h|Z)(z + 2\theta)dzd\theta. \end{aligned}$$

An instructive interpretation of this is that as x ranges over X and n ranges over non-negative integers, the triple $(x, T^n x, T^{2n} x)$ ranges “freely” over $X \times X \times X$ subject to the condition that $\varphi(x), \varphi(T^n x), \varphi(T^{2n} x)$ form an arithmetic progression in Z , where $\varphi : X \rightarrow Z$ is the projection of X to its Kronecker factor. Thus the role played by the characteristic factor here is that of determining the constraints on $(x, T^n x, T^{2n} x)$. It is remarkable that the constraints are purely algebraic.

There is a situation when no constraints exist on $(x, T^{p_1(n)}x, T^{p_2(n)}x, \dots, T^{p_k(n)}x)$. Another way of saying this is to say that the characteristic factor of \mathbf{X} for $\{p_1(n), p_2(n), \dots, p_k(n)\}$ is trivial so that

$$\frac{1}{N} \sum T^{p_1(n)} f_1 T^{p_2(n)} f_2 \dots T^{p_k(n)} f_k \rightarrow \int f_1 d\mu \cdot \int f_2 d\mu \dots \int f_k d\mu$$

in $L^2(X, \mathcal{B}, \mu)$. This will be the case when \mathbf{X} is weakly mixing - or a WM extension of the trivial system - provided the polynomials $p_i - p_j$ for $i \neq j$ differ not only in their constant term. This result was proved by Bergelson [BE87] and the proof makes repeated use of the Hilbert space van der Corput lemma.

4. Geometric Progressions in Nilpotent Groups and on Nilmanifolds

Turning to the general case, one finds that for $k > 2$ the $(k + 1)$ -tuples $(x, T^n x, T^{2n} x, \dots, T^{kn} x)$ are subject to further restrictions not implicit in the projection to a $(k+1)$ -term arithmetic progression in the Kronecker factor of the system $\mathbf{X} = (X, \mathcal{B}, \mu, T)$. These come from “nil-factors”, i.e., factors (Y, \mathcal{D}, ν, S) where $Y = \mathcal{N}/\Gamma$, \mathcal{N} a nilpotent Lie group, Γ a cocompact discrete subgroup. ν is an \mathcal{N} -invariant measure, and $S(u\Gamma) = a_\circ u\Gamma$ for a_\circ fixed in \mathcal{N} . The existence of a nil-factor $\pi : X \rightarrow \mathcal{N}/\Gamma$ for a nilpotent group \mathcal{N} of level $k - 1$ imposes an algebraic condition on $(k + 1)$ -tuples $(x, T^n x, T^{2n} x, \dots, T^{kn} x)$. This condition can be stated as the requirement that $(\pi(x), \pi(T^n x), \dots, \pi(T^{kn} x))$ belong to a submanifold of $(\mathcal{N}/\Gamma)^{k+1}$ which we designate $HP_{k+1}(\mathcal{N}/\Gamma)$. H-P stands for Hall and Petresco who studied the term by term products of geometric progressions for non-commutative groups, these no longer having to be geometric progressions.

Definition. Let $G \supset G^{(1)} \supset G^{(2)} \supset \dots$ be the lower central series of a group G , $G^{(i+1)} = [G, G^{(i)}]$. A $(k + 1)$ -term sequence $\{u_0, u_1, u_2, \dots, u_k\}$ is an HP_{k+1} -sequence if there exist $x_1 \in G, x_2 \in G^{(1)}, \dots, x_k \in G^{(k-1)}$ so that

$$u_1 = x_1 u_0, u_2 = x_2 x_1^2 u_0, u_3 = x_3 x_2^3 x_1^3 u_0, u_4 = x_4 x_3^4 x_2^4 x_1^4 u_0, \dots, u_k = x_k x_{k-1}^k \dots x_1^k u_0.$$

The significance of this notion is that the HP_{k+1} sequences form a group in G^{k+1} ([LE98], [TT09, p. 217]). We can define the projection of such sequences on a homogeneous space G/Γ as HP_{k+1} -progressions which form a subvariety of $(G/\Gamma)^{k+1}$. The role played by nilpotence comes from the following:

Lemma. *If \mathcal{N} is k -step nilpotent, i.e., $\mathcal{N}^{(k)} = \{1\}$, then the first $k + 1$ terms of an HP_ℓ -progression, $\ell > k + 1$, determine all successive terms.*

Now let \mathbf{X} be an arbitrary m.p.s. possessing a k -step nilfactor, then the projections $\pi(x), \pi(T^n x), \dots, \pi(T^{\ell n} x)$ form a $HP_{\ell+1}$ sequence on the factor and this imposes new constraints on $(x, T^n x, T^{2n} x, \dots, T^{\ell n} x)$. As in the case of $\{n, 2n\}$ these constraints turn out to be the only ones on $(x, T^n x, T^{2n} x, \dots, T^{kn} x)$. To make this precise we formulate the notion of a k -step pro-nilsystem: a k -step pro-nilsystem is an inverse limit of nilsystems $\varprojlim \mathcal{N}_j / \Gamma_j$ where \mathcal{N}_j is a nilpotent Lie group with $\mathcal{N}_j^{(k)} = \{1\}$, and on each of these the measure preserving action is translation by an element of \mathcal{N}_j , so that the inverse system is consistently defined. Every ergodic system \mathbf{X} will have a maximal k -step pro-nilflow factor \mathbf{Z}_k and Ziegler's theorem asserts that \mathbf{Z}_k is characteristic for $\{n, 2n, \dots, kn\}$, and, more generally, for any linear family $\{a_1 n, a_2 n, \dots, a_k n\}$ with distinct a_i [ZI07].

As remarked earlier, a consequence of this identification of the characteristic factor for any ergodic system enables us to prove convergence in $L^2(X, \mathcal{B}, \mu)$ of

$$\frac{1}{N} \sum_{n=1}^N f_1(T^{a_1 n} x) f_2(T^{a_2 n} x) \cdots f_k(T^{a_k n} x)$$

as $N \rightarrow \infty$, since this will now follow for any system once it is known for translations on nilmanifolds. For nilmanifolds this was established in 1969 by W. Parry ([PA69]), and is also a special case of theorems of N. Shah ([SH96]) and Leibman ([LE05]). An explicit description of the limit appears in [ZI05] and for the special case $k = 3$ was given by E. Lesigne ([Le89]). The entire theory was developed for $k = 3$ by J.P. Conze and E. Lesigne in [CL84] and [CL87], who first recognized the role of nilmanifolds for 3-term non-conventional averages.

In fact pro-nilsystems serve as characteristic factors for any scheme, and both the polynomial mean ergodic theorem and polynomial multiple recurrence can be deduced from this. With the identification of the characteristic factor for any scheme, the polynomial mean ergodic theorem as well as a polynomial multiple recurrence theorem will follow for arbitrary measure preserving systems, once they are known for nilsystems. As regards the polynomial mean ergodic theorem one has available for nilsystems a pointwise ergodic theorem which is valid for all points for continuous functions by results of Leibman ([LE05]). In addition, the analysis of distribution of polynomial orbits on a nilmanifold leads to the following refinement of our earlier multiple recurrence theorem:

Call a set of integer valued polynomial $\{q_1(n), \dots, q_r(n)\}$ *intersective* if for any $m \in \mathbb{N}$, there exists n such that m divides each $q_i(n)$. Then if $\{q_1(n), \dots, q_r(n)\}$ is an intersective family, for any m.p.s. $\mathbf{X} = (X, \mathcal{B}, \mu, T)$ and $A \in \mathcal{B}$ with $\mu(A) > 0$ there exists an integer n with $\mu(A \cap T^{-q_1(n)} A \cap T^{-q_2(n)} A \cap \dots \cap T^{-q_r(n)} A) > 0$.

Note that the sufficient condition for multiple recurrence given in §2 is a special case of the above. But there are intersective families of polynomials which don't have a common 0 and so the present theorem is strictly stronger

than the earlier one. This is noteworthy since the theorem in [BL96] makes use implicitly of the distal factor of a given ergodic system, whereas the present refinement in [BLL08] makes use of a special distal factor - namely, the pro-nilfactor.

5. Conze-Lesigne Factors

The main result of these investigations is identifying the nilfactor of an ergodic system as the characteristic factor for all schemes. Two approaches have been taken up and these show up in considering the schemes $\{a_1n, a_2n, \dots, a_kn\}$. The approach of Conze and Lesigne has been mentioned and this was generalized by T. Ziegler from the case $k = 3$ to arbitrary k ([ZI07]). In line with this approach is the treatment in [FW96] of characteristic factors for $\{a_1n, a_2n, a_3n\}$ which, as is shown there, is also characteristic for $\{n, n^2\}$. This was the first instance of a non-linear scheme to be treated, and for which a mean ergodic theorem was proved. B. Host and B. Kra have an entirely different approach leading ultimately to the same conclusion ([HK05]).

We begin with what can be called the Conze-Lesigne approach. With Ziegler ([ZI07]) we denote by $\mathbf{Y}_k = \mathbf{Y}_k(\mathbf{X})$ the “universal” characteristic factor for schemes $\{a_1n, a_2n, \dots, a_kn\}$ which, first of all, is shown to exist. It is manifest that \mathbf{Y}_{k+1} is an extension of \mathbf{Y}_k . It can be shown to be an isometric extension and moreover an extension $Y_{k+1} = Y_k \times W_k$, where W_k is a compact abelian group. The action on Y_{k+1} is given by $T(y, w) = (Ty, \rho(y)w)$ and further analysis shows that the “cocycle” ρ is not arbitrary but satisfies a functional equation. This has led to the important notion of a “Conze-Lesigne cocycle” which appears in contemporary treatments of more general convergence questions. In the simplest situation $k = 2$ where \mathbf{Y}_2 has already been shown to coincide with the Kronecker factor $(\tilde{Z}, \tilde{\alpha})$ of \mathbf{X} , the Conze-Lesigne condition takes the form: there exist measurable functions K and L with

$$\frac{\rho(z+u)}{\rho(z)} = K(u) \frac{L(u, z+\alpha)}{L(u, z)}.$$

Conze and Lesigne arrived at this equation in their direct treatment of convergence of ergodic averages, but Ziegler makes use of it and its analogs for higher k to show that the k -universal factor is a $(k-1)$ -step pro-nilsystem which can be denoted $\mathbf{Z}_{k-1}(\mathbf{X})$.

6. Gowers Seminorms and Host-Kra Factors

In his proof of Szemerédi’s theorem ([GO01]), T. Gowers introduced a notion of mixing (he calls it “uniformity”) which is useful in studying non-conventional averages. With B. Host and B. Kra one defines an ergodic theoretic analog of an

expression studied by Gowers: the k -seminorm $\|f\|_k$ of a bounded measurable function which can be defined inductively by

$$\|f\|_{k+1}^{2^{k+1}} = \lim_{N \rightarrow \infty} \frac{1}{N} \sum_{n=1}^N \|f \cdot T^n f\|_k^{2^k},$$

and $\|f\|_0 = \int f d\mu$. These are non-decreasing with k so that the condition $\|f\|_k = 0$ becomes more and more restrictive. It can be shown that if f is orthogonal to the distal component of a system \mathbf{X} , then $\|f\|_k = 0$ for all k . On the other hand $\|f\|_k = 0$ if $f \perp g$ for functions g on X coming from the $(k - 1)$ -step pro-nilfactor, and indeed this nilfactor can be characterized by this quantitative condition on its orthogonal complement. A direct definition of $\|f\|_k$ is given in [HK05] where the seminorm appears as an autocorrelation of values of a function on “cubes”, these being special 2^k -tuples of points in X . For our purposes, the main result is the theorem of Leibman [LE05,1].

Theorem. *For any $r, b \in \mathbb{N}$ there exists $k \in \mathbb{N}$ such that for any system of non-constant essentially distinct integer valued polynomials p_1, \dots, p_r of degree $\leq b$ and any $f_1, f_2, \dots, f_r \in L^\infty(X, \mathcal{B}, \mu)$ for a m.p.s. \mathbf{X} for which $\|f_1\|_k = 0$, one has*

$$\frac{1}{N} \sum_0^{N-1} T^{p_1(n)} f_1 T^{p_2(n)} f_2 \dots T^{p_r(n)} f_r \rightarrow 0$$

in $L^2(X, \mathcal{B}, \mu)$ as $N \rightarrow \infty$.

It follows from this theorem that for any scheme $\{p_1(n), p_2(n), \dots, p_r(n)\}$, the $(k - 1)$ -step pro-nilfactor of \mathbf{X} serves as a characteristic factor provided k is sufficiently large.

Pro-nilfactors appear as characteristic in a related but different context. Namely one can form multi-parameter averages:

$$\lim_{N_1, N_2, \dots, N_k \rightarrow \infty} \frac{1}{N_1 N_2 \dots N_k} \sum_{n_1=1}^{N_1} \sum_{n_2=1}^{N_2} \dots \sum_{n_k=1}^{N_k} \prod_{\varepsilon_1, \dots, \varepsilon_k \in \{0,1\}} T^{\varepsilon_1 n_1 + \dots + \varepsilon_k n_k} f_{\varepsilon_1 \varepsilon_2 \dots \varepsilon_k} d\mu.$$

These were first considered by Bergelson for $k = 2$, who showed that

$$\lim_{N_1, N_2 \rightarrow \infty} \frac{1}{N_1 N_2} \sum_{n_1=1}^{N_1} f(T^{n_1} x) f(T^{n_1} x) g(T^{n_2} x) h(T^{n_1+n_2} x)$$

exists in $L^2(X, \mathcal{B}, \mu)$. It turns out that $\mathbf{Z}_{k-1}(\mathbf{X})$ is a characteristic factor (in this extended sense) for this expression as well. ([BE00])

We have only skimmed the surface of a large area, which is still growing. Much work has already been done when powers of a single transformation are replaced by more general commuting transformations. Another notion of interest is that of *IP*-limit (see [BE06]) replacing the usual average. This plays a central role in establishing a density version of the Hales-Jewett theorem. See [FK85] and [BM00] for further details.

References

- [BE87] V. Bergelson, *Weakly mixing PET*, Ergodic Theory and Dynamical Systems **7** (1987), 337–349.
- [BE00] V. Bergelson, *The multifarious Poincaré recurrence theorem* in *Descriptive Set Theory and Dynamical Systems*, Eds. M. Foreman, A.S. KeCHRIS, A. Louveau, B. Weiss. Cambridge Univ. Press, New York, 2000, 31–57.
- [BE06] V. Bergelson, *Combinatorial and diophantine applications of ergodic theory*, in *Handbook of Dynamical Systems, vol. 1B* with appendix by A. Leibman, p. 844.
- [BL96] V. Bergelson and A. Leibman, *Polynomial extensions of van der Waerden’s and Szemerédi’s theorems*, J. Amer. Math. Soc. **9** (1996), 725–753.
- [BLL08] V. Bergelson, A. Leibman and E. Lesigne, *Intersective polynomials and the polynomial Szemerédi theorem*, Adv. Math. **219** (2008), no. 1, p. 369.
- [BM00] V. Bergelson and R. McCutcheon, *An ergodic IP polynomial Szemerédi theorem*, Mem. Amer. Math. Soc. **146** (2000), no. 695, viii+106 pp.
- [CL84] J.P. Conze and E. Lesigne, *Théorèmes ergodiques pour des mesures diagonales*, Bull. Soc. Math. France **112** (1984), no. 2, 143–175.
- [CL87] J.P. Conze and E. Lesigne, *Sur un théorème ergodique pour des mesures diagonales*, Publ. Inst. Recherch Math. Rennes 1987-1, Univ. Rennes I Rennes.
- [DO53] J.L. Doob, *Stochastic Processes*, Wiley, New York, 1953.
- [EW10] M. Einsiedler and T. Ward, *Ergodic Theory with a view towards Number Theory*, Springer, Berlin, 2010, p. 178.
- [FK78] H. Furstenberg and Y. Katznelson, *An ergodic Szemerédi theorem for commuting transformations*, J. Analyse Math. **34** (1978), 275–291 (1979).
- [FK85] H. Furstenberg and Y. Katznelson, *An ergodic Szemerédi theorem for IP-systems and combinatorial theory*, J. Analyse Math. **45** (1985), 117–168.
- [FU77] H. Furstenberg, *Ergodic behavior of diagonal measures and a theorem of Szemerédi on arithmetic progressions*, J. Analyse Math. **31** (1977), 204–256.
- [FU81] H. Furstenberg, *Recurrence in Ergodic theory and Combinatorial Number Theory*, Princeton University Press, Princeton, NJ, 1981.
- [FKO82] H. Furstenberg, Y. Katznelson and D. Ornstein, *The ergodic theoretical proof of Szemerédi’s theorem*, Bull. Amer. Math. Soc. (N.S.) **7** (1982), no. 2, 527–552.
- [FW96] H. Furstenberg and B. Weiss, *A mean ergodic theorem for $\frac{1}{N} \sum f(T^n x)g(T^{n^2} x)$* in *Convergence in Ergodic theory and Probability*, Columbus OH, Ohio State University Math. Res. Inst. Publicatins, vol. 5, p. 193.
- [GL03] E. Glasner, *Ergodic Theory via Joinings*, Mathematical Surveys and Monographs, vol. **101**, A.M.S., Providence, RI, 2003.
- [GO01] W.T. Gowers, *A new proof of Szemerédi’s theorem*, Geom. and Functional Analysis **11** (2001), 465.

- [HK01] B. Host and B. Kra, *Convergence of Conze-Lesigne average*, Ergodic Theory and Dynamical Systems **21** (2001) no. 2, 493–509.
- [HK05] B. Host and B. Kra, *Nonconventional ergodic averages and nilmanifolds*, Annals of Math. (2) **161** (2005), p. 397.
- [LE98] A. Leibman, *Polynomial sequences in groups*, J. Algebra **201** (1998), 189–206.
- [LE05] A. Leibman, *Convergence of multiple ergodic averages along polynomials of several variables*, Israel Journal of Mathematics **146** (2005), p. 303.
- [LE05,1] A. Leibman, *Pointwise convergence of ergodic averages for polynomial sequences of translations on a nilmanifold*, Ergodic Theory and Dynamical Systems **25** (2005), part 1, p. 201.
- [Le89] E. Lesigne, *Théorèmes ergodiques pour une translation sur une nilvariété*, Ergodic Theory and Dynamical Systems **9** (part 1, 1989), p. 115.
- [PA69] W. Parry, *Ergodic properties of affine transformations and flows on nilmanifolds*, Amer. J. Math. **91** (1969), p. 757.
- [SH96] N. Shah, *Invariant measures and orbit closures on homogeneous spaces for actions of subgroups*, Lie Groups and Ergodic Theory, (Mumbai 1996), 229, Tata Institute Studies in Mathematics **14**.
- [TT09] T. Tao, *A Ratner-type theorem for nilmanifolds*, in *Poincaré’s Legacies, Part I*, Amer. Math. Society, Providence, RI, 2009, p. 217.
- [ZI05] T. Ziegler, *A non-conventional ergodic theorem for a nilsystem*, Ergodic Theory and Dynamical Systems **25** part 4, (2005), p. 1357.
- [ZI07] T. Ziegler, *Universal Characteristic factors and Furstenberg averages*, J. Amer. Math. Soc. **20** (2007), p. 53.

Isogeometric Analysis

Thomas J.R. Hughes* and John A. Evans

Abstract

We present an introduction to Isogeometric Analysis, a new methodology for solving partial differential equations (PDEs) based on a synthesis of Computer Aided Design (CAD) and Finite Element Analysis (FEA) technologies. A prime motivation for the development of Isogeometric Analysis is to simplify the process of building detailed analysis models for complex engineering systems from CAD representations, a major bottleneck in the overall engineering process. However, we also show that Isogeometric Analysis is a powerful methodology for providing more accurate solutions of PDEs, and we summarize recently obtained mathematical results and describe open problems.

Mathematics Subject Classification (2010). Primary 65N30; Secondary 65D07.

Keywords. isogeometric analysis, finite element analysis, NURBS, error estimates, vibrations, Kolmogorov n -widths, smooth discretizations, compatible discretizations

1. Introduction

Designers generate CAD (Computer Aided Design) files and these must be translated into analysis-suitable geometries, meshed and input to large-scale finite element analysis (FEA) codes. This task is far from trivial and for complex engineering designs is now estimated to take over 80% of the overall analysis time, and engineering designs are becoming increasingly more complex; see Figure 1. For example, presently, a typical automobile consists of about 3,000 parts, a fighter jet over 30,000, the Boeing 777 over 100,000, and a modern nuclear submarine over 1,000,000. Engineering design and analysis are not separate endeavors. Design of sophisticated engineering systems is based on a wide range of computational analysis and simulation methods, such as structural mechanics, fluid dynamics, acoustics, electromagnetics, heat transfer, etc. Design speaks to analysis, and analysis speaks to design. However, analysis-suitable models

*Institute for Computational Engineering and Sciences, University of Texas at Austin, 1 University Station, Austin, Texas 78735, U.S.A. E-mail: hughes@ices.utexas.edu

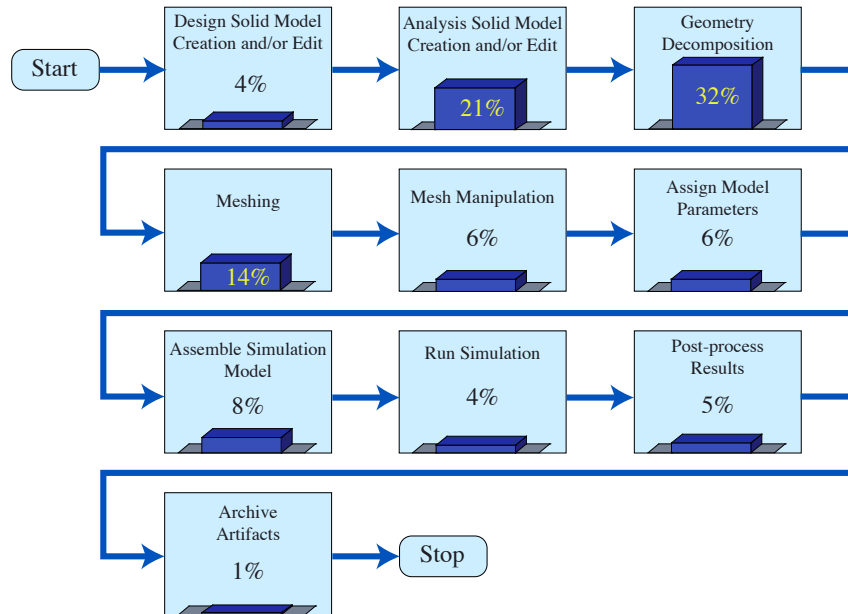

Figure 1. Engineering designs are becoming increasingly complex, making analysis a time consuming and expensive endeavor. (Courtesy of General Dynamics / Electric Boat Division.)

are not automatically created or readily meshed from CAD geometry. Although not always appreciated in the academic analysis community, model generation is much more involved than simply generating a mesh. There are many time consuming, preparatory steps involved. And one mesh is no longer enough. According to Steve Gordon, Principal Engineer, General Dynamics Electric Boat Corporation, “We find that today’s bottleneck in CAD-CAE integration is not only automated mesh generation, it lies with efficient creation of appropriate ‘simulation-specific’ geometry.” (In the commercial sector analysis is usually referred to as CAE, which stands for Computer Aided Engineering.) The anatomy of the process has been studied by Ted Blacker, Manager of Simulation Sciences, Sandia National Laboratories. At Sandia, mesh generation accounts for about 20% of overall analysis time, whereas creation of the analysis-suitable geometry requires about 60%, and only 20% of overall time is actually devoted to analysis per se; see Figure 2. The 80/20 modeling/analysis ratio seems to be a very common industrial experience, and there is a strong desire to reverse it, but so far little progress has been made, despite enormous effort to do so. The integration of CAD and FEA has proven a formidable problem. It seems that fundamental changes must take place to fully integrate engineering design and analysis processes.

It is apparent that the way to break down the barriers between engineering design and analysis is to reconstitute the entire process, but at the same

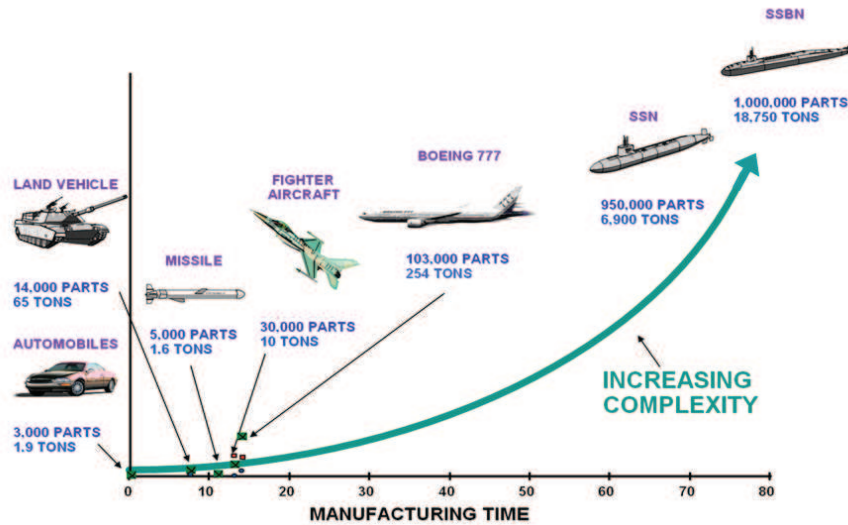

Figure 2. Estimation of the relative time costs of each component of the model generation and analysis process at Sandia National Laboratories. Note that the process of building the model completely dominates the time spent performing analysis. (Courtesy of Michael Hardwick and Robert Clay, Sandia National Laboratories.)

time maintain compatibility with existing practices. A fundamental step is to focus on one, and only one, geometric model, which can be utilized directly as an analysis model, or from which geometrically precise analysis models can be automatically built. This will require a change from classical FEA to an analysis procedure based on CAD representations. This concept is referred to as *Isogeometric Analysis*, and it was introduced in [21]. Since then a number of additional papers have appeared [1, 2, 3, 5, 6, 7, 8, 9, 13, 14, 16, 18, 19] as well as a book [12].

There are a number of candidate computational geometry technologies that may be used in Isogeometric Analysis. The most widely used in engineering design are NURBS (non-uniform rational B-splines), the industry standard (see [17, 22, 23, 11]). The major strengths of NURBS are that they are convenient for free-form surface modeling, can exactly represent all conic sections, and therefore circles, cylinders, spheres, ellipsoids, etc., and that there exist many efficient and numerically stable algorithms to generate NURBS objects. They also possess useful mathematical properties, such as the ability to be refined through knot insertion, C^{p-1} -continuity for p th-order NURBS, and the variation diminishing and convex hull properties. NURBS are ubiquitous in CAD systems, representing billions of dollars in development investment. One may argue the merits of NURBS versus other computational geometry technologies, but their preeminence in engineering design is indisputable. As such, they were the natural starting point for Isogeometric Analysis and their use in an analysis setting is the focus of this paper.

T-splines [24, 25] are a recently developed forward and backward generalization of NURBS technology. T-splines extend NURBS to permit local refinement and coarsening, and are very robust in their ability to efficiently sew together adjacent patches. Commercial T-spline plug-ins have been introduced in Maya and Rhino, two NURBS-based design systems (see references [27] and [28]). Initiatory investigations of T-splines in an Isogeometric Analysis context have been undertaken by [4] and [15]. These works point to a promising future for T-splines as an isogeometric technology.

2. Basics of NURBS-based Isogeometric Analysis

In FEA there is one notion of a mesh and one notion of an element, but an element has two representations, one in the parent domain and one in the physical space. Elements are usually defined by their nodal coordinates and the degrees-of-freedom are usually the values of the basis functions at the nodes. Finite element basis functions are typically interpolatory and may take on positive and negative values. Finite element basis functions are often referred to as “interpolation functions,” or “shape functions.” See [20] for a discussion of the basic concepts.

In NURBS, the basis functions are usually not interpolatory. There are two notions of meshes, the control mesh¹ and the physical mesh. The control points define the control mesh, and the control mesh interpolates the control points. The control mesh consists of multilinear elements, in two dimensions they are bilinear quadrilateral elements, and in three dimensions they are trilinear hexahedra. The control mesh does not conform to the actual geometry. Rather, it is like a scaffold that controls the geometry. The control mesh has the look of a typical finite element mesh of multilinear elements. The control variables are the degrees-of-freedom and they are located at the control points. They may be thought of as “generalized coordinates.” Control elements may be degenerated to more primitive shapes, such as triangles and tetrahedra. The control mesh may also be severely distorted and even inverted to an extent, while at the same time, for sufficiently smooth NURBS, the physical geometry may still remain valid (in contrast with finite elements).

The physical mesh is a decomposition of the actual geometry. There are two notions of elements in the physical mesh, the patch and the knot span. The patch may be thought of as a macro-element or subdomain. Most geometries utilized for academic test cases can be modeled with a single patch. Each patch has two representations, one in a parent domain and one in physical space.

¹The control mesh is also known as the “control net,” the “control lattice,” and curiously the “control polygon” in the univariate case.

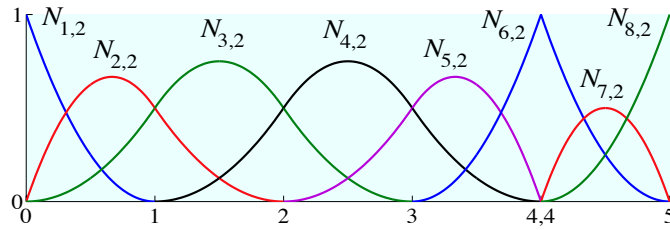

Figure 3. Quadratic B-spline basis functions for open, non-uniform knot vector $\Xi = \{0, 0, 0, 1, 2, 3, 4, 4, 5, 5, 5\}$.

In two-dimensional topologies, a patch is a rectangle in the parent domain representation. In three dimensions it is a cuboid.

Each patch can be decomposed into knot spans. Knots are points, lines, and surfaces in one-, two-, and three-dimensional topologies, respectively. Knot spans are bounded by knots. These define element domains where basis functions are smooth (*i.e.*, C^∞). Across knots, basis functions will be C^{p-m} where p is the degree² of the polynomial and m is the multiplicity of the knot in question. Knot spans are convenient for numerical quadrature. They may be thought of as micro-elements because they are the smallest entities we deal with. They also have representations in both a parent domain and physical space. When we speak of “elements” without further description, we usually mean knot spans.

There is one other very important notion that is a key to understanding NURBS, the *index space* of a patch. It uniquely identifies each knot and discriminates among knots having multiplicity greater than one.

NURBS basis functions are the rational counterpart of standard B-spline basis functions. For a discussion of the construction of B-spline basis functions on the parent domain from preassigned knot vectors, see Chapter 2 of [12]. A quadratic example is presented in Figure 3. B-spline basis functions exhibit many desirable properties, including partition of unity, compact support, and point-wise positivity. Multi-dimensional basis functions are defined through a tensor product, and basis functions are defined in physical space through a *push-forward*, *i.e.* by considering a composition with the inverse of the geometrical mapping. In Isogeometric Analysis, the *isoparametric* concept is invoked. That is, the same basis is used for both geometry and analysis. Analogues of h - and p -refinement also exist in Isogeometric Analysis in the form of knot insertion and order elevation, and there is a new refinement scheme called k -refinement. See Chapter 2.1.4 of [12].

²There is a terminology conflict between the geometry and analysis communities. Geometers will say a cubic polynomial has degree 3 and order 4. In geometry, order equals degree plus one. Analysts will say a cubic polynomial is order three, and use the terms order and degree synonymously. This is the convention we adhere to.

See Table 2 for a summary of NURBS paraphernalia employed in Isogeometric Analysis. A schematic illustration of the ideas is presented in Figure 4 for a NURBS surface in \mathbb{R}^3 . For more details on B-splines and NURBS, see [17, 22, 23, 11].

Index Space		
Control Mesh	Physical Mesh	
Multilinear Control Elements	Patches	Knot Spans
<p>Topology:</p> <p>1D: Straight lines defined by two consecutive control points</p>	<p>Patches: Images of rectangular meshes in the parent domain mapped into the actual geometry. Patches may be thought of as macro-elements or subdomains.</p>	<p>Topology of knots in the parent domain:</p> <p>1D: Points</p> <p>2D: Lines</p> <p>3D: Planes</p>
<p>2D: Bilinear quadrilaterals defined by four control points</p>	<p>Topology:</p> <p>1D: Curves</p> <p>2D: Surfaces</p> <p>3D: Volumes</p>	<p>Topology of knots in the physical space:</p> <p>1D: Points</p> <p>2D: Curves</p> <p>3D: Surfaces</p>
<p>3D: Trilinear hexahedra defined by eight control points</p>	<p>Patches are decomposed into knot spans, the smallest notion of an element.</p>	<p>Topology of knots spans, <i>i.e.</i>, “elements”:</p> <p>1D: Curved segments connecting consecutive knots</p> <p>2D: Curved quadrilaterals bounded by four curves</p> <p>3D: Curved hexahedra bounded by six curved surfaces</p>

Table 1. NURBS paraphernalia in Isogeometric Analysis

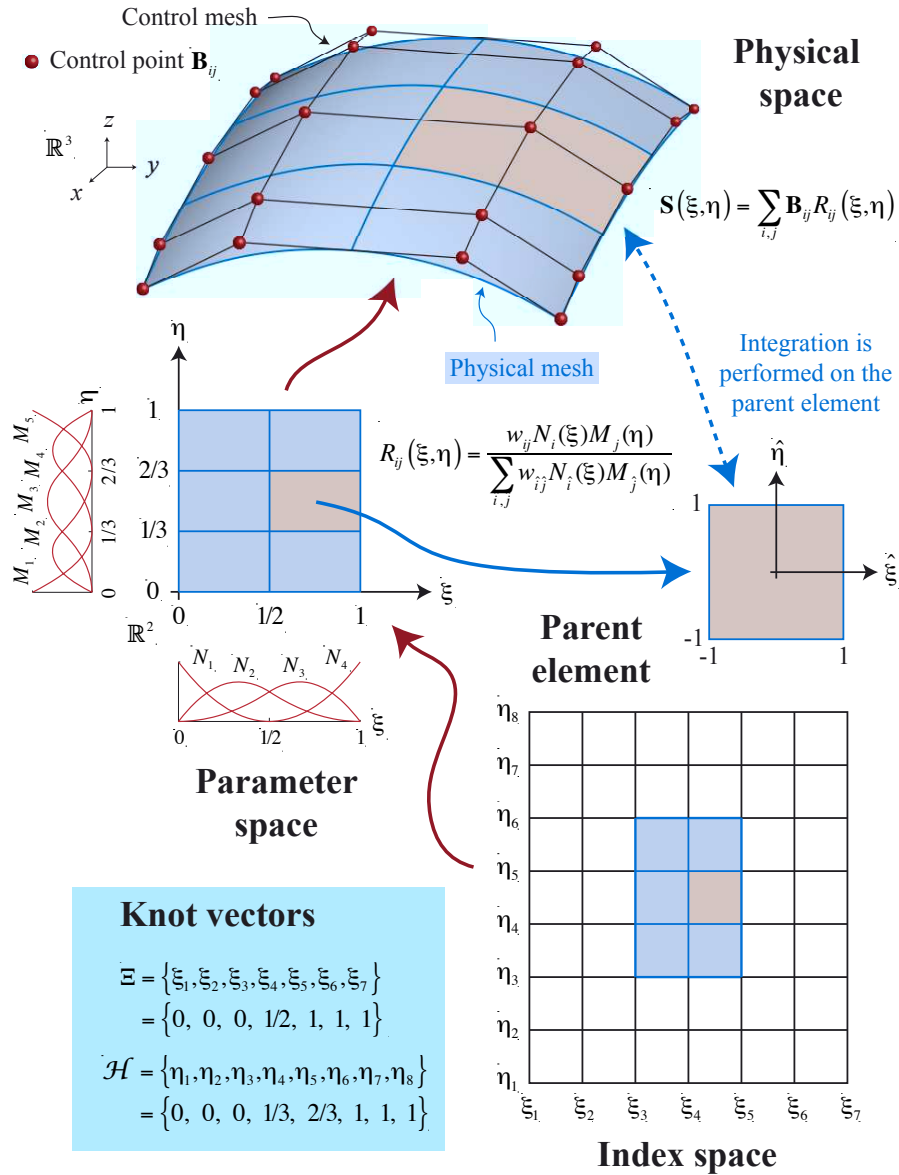

Figure 4. Schematic illustration of NURBS paraphernalia for a one-patch surface model. Open knot vectors and quadratic C^1 -continuous basis functions are used. Complex multi-patch geometries may be constructed by assembling control meshes as in standard FEA. Also depicted are C^1 -quadratic ($p = 2$) basis functions determined by the knot vectors. Basis functions are multiplied by control points and summed to construct geometrical objects, in this case a surface in \mathbb{R}^3 . The procedure used to define basis functions from knot vectors is described in detail in Chapter 2 of [12].

3. Boundary Value Problems

As an example of solving a differential equation posed over the domain defined by a NURBS geometry, let us consider Laplace's equation. The goal is to find $u : \bar{\Omega} \rightarrow \mathbb{R}$ such that

$$\Delta u + f = 0 \quad \text{in } \Omega, \quad (1a)$$

$$u = g \quad \text{on } \Gamma_D, \quad (1b)$$

$$\nabla u \cdot \mathbf{n} = h \quad \text{on } \Gamma_N, \quad (1c)$$

$$\beta u + \nabla u \cdot \mathbf{n} = r \quad \text{on } \Gamma_R, \quad (1d)$$

where $\overline{\Gamma_D \cup \Gamma_N \cup \Gamma_R} = \Gamma \equiv \partial\Omega$, $\Gamma_D \cap \Gamma_N \cap \Gamma_R = \emptyset$, and \mathbf{n} is the unit outward normal vector $\partial\Omega$. The functions $f : \Omega \rightarrow \mathbb{R}$, $g : \Gamma_D \rightarrow \mathbb{R}$, $h : \Gamma_N \rightarrow \mathbb{R}$, and $r : \Gamma_R \rightarrow \mathbb{R}$ are all given, as is the constant β . Equation (1) constitutes the **strong form** of the boundary value problem (BVP). The boundary conditions given in (1b), (1c), and (1d) represent the three major types of boundary conditions one is likely to encounter. These are Dirichlet conditions, Neumann conditions, and Robin conditions, respectively.

For a sufficiently smooth domain, and under certain restrictions on g , h , and r , a unique solution u satisfying (1) is known to exist, but an analytical expression will usually be impossible to obtain. However, we may seek an approximate solution of the form

$$u^h = \sum_A d_A N_A \quad (2)$$

where N_A is a basis function and d_A is an unknown to be determined. We generically refer to techniques for doing so as **numerical methods**. Different numerical methods are simply different techniques for finding d_A such that $u^h \approx u$. We focus here on the Bubnov-Galerkin method that underlies most of modern FEA.

The technique begins by defining a weak, or variational, counterpart of (1). To do so, we need to characterize two classes of functions. The first is to be composed of candidate, or trial solutions. From the outset, these functions will be required to satisfy the Dirichlet boundary condition of (1b).

To define the trial and weighting spaces formally, let us first define the space of square integrable functions on Ω . This space, called $L^2(\Omega)$, is defined as the collection of all functions $u : \Omega \rightarrow \mathbb{R}$ such that

$$\int_{\Omega} u^2 d\Omega < +\infty. \quad (3)$$

Let us consider a multi-index $\boldsymbol{\alpha} \in \mathbb{N}^d$ where d is the number of spatial dimensions in the space. For $\boldsymbol{\alpha} = \{\alpha_1, \dots, \alpha_d\}$, we define $|\boldsymbol{\alpha}| = \sum_{i=1}^d \alpha_i$. We now have a concise way to represent derivative operators. Let $D^{\boldsymbol{\alpha}} = D_1^{\alpha_1} D_2^{\alpha_2} \dots D_d^{\alpha_d}$, where $D_i^j = \frac{\partial^j}{\partial x_i^j}$. So that certain expressions to be employed in the formulation

make sense, we shall require that the derivatives of the trial solutions be square-integrable. Such a function is said to be in the Sobolev space $H^1(\Omega)$, which is characterized by

$$H^1(\Omega) = \{u \mid D^\alpha u \in L^2(\Omega), |\alpha| \leq 1\}. \quad (4)$$

We may now define the collection of **trial solutions**, denoted by \mathcal{S} , as all of the function which have square-integrable derivatives and that also satisfy

$$u|_{\Gamma_D} = g. \quad (5)$$

This is written as

$$\mathcal{S} = \{u \mid u \in H^1(\Omega), u|_{\Gamma_D} = g\}. \quad (6)$$

The second collection of functions in which we are interested is called the **weighting functions**. This collection is very similar to the trial functions, except that we have the homogeneous counterpart of the Dirichlet boundary condition. That is, the weighting functions are denoted by a set \mathcal{V} defined by

$$\mathcal{V} = \{w \mid w \in H^1(\Omega), w|_{\Gamma_D} = 0\}. \quad (7)$$

We may now obtain a variational statement of the BVP by multiplying (1a) by an arbitrary test function $w \in \mathcal{V}$ and integrating by parts, incorporating (1c) and (1d) as needed. The resulting weak form of the problem is now: Given f , g , h , and r , find $u \in \mathcal{S}$ such that for all $w \in \mathcal{V}$

$$\begin{aligned} & \int_{\Omega} \nabla w \cdot \nabla u \, d\Omega + \beta \int_{\Gamma_R} w u \, d\Gamma \\ &= \int_{\Omega} w f \, d\Omega + \int_{\Gamma_N} w h \, d\Gamma + \int_{\Gamma_R} w r \, d\Gamma. \end{aligned} \quad (8)$$

This weak form may be rewritten as

$$a(w, u) = L(w) \quad (9)$$

where

$$a(w, u) = \int_{\Omega} \nabla w \cdot \nabla u \, d\Omega + \beta \int_{\Gamma_R} w u \, d\Gamma, \quad (10)$$

and

$$L(w) = \int_{\Omega} w f \, d\Omega + \int_{\Gamma_N} w h \, d\Gamma + \int_{\Gamma_R} w r \, d\Gamma. \quad (11)$$

This concise notation, or variants thereof, is quite common in the finite element literature. For problems other than the Laplace equation, the details vary, but the basic form remains. It captures the essential mathematical features of the variational method (as well as suggesting features of a finite element implementation) that are more general than the details of the equation itself.

The solution to (8), or equivalently (9), is called a **weak solution**. Under appropriate regularity assumptions, it can be shown that the weak solution and the strong solution of (1) are equivalent; see [20].

The Bubnov-Galerkin method, abbreviated as Galerkin's method, consists of constructing finite-dimensional approximations of \mathcal{S} and \mathcal{V} , denoted \mathcal{S}^h and \mathcal{V}^h , respectively. Strictly speaking, these will be subsets such that

$$\mathcal{S}^h \subset \mathcal{S}, \quad (12)$$

$$\mathcal{V}^h \subset \mathcal{V}. \quad (13)$$

Furthermore, these will be associated with subsets of the space spanned by the isoparametric basis. In Isogeometric Analysis, these spaces consist of mapped NURBS functions.

We can further characterize \mathcal{S}^h by recognizing that if we have a *given* function $g^h \in \mathcal{S}^h$ such that $g^h|_{\Gamma_D} = g$, then for every $u^h \in \mathcal{S}^h$, there exists a unique $v^h \in \mathcal{V}^h$ such that

$$u^h = v^h + g^h. \quad (14)$$

We can now write a variational equation of the form of (9). The Galerkin form of the problem is: Given g^h , h , and r , find $u^h = v^h + g^h$, where $v^h \in \mathcal{V}^h$, such that for all w^h in \mathcal{V}^h

$$a(w^h, u^h) = L(w^h). \quad (15)$$

Recalling (14) and the bilinearity of $a(\cdot, \cdot)$, we can rewrite (15) as

$$a(w^h, v^h) = L(w^h) - a(w^h, g^h). \quad (16)$$

In this latter form, the unknown information is on the left-hand-side, while everything on the right-hand-side is given, as before.

The finite-dimensional nature of the function spaces used in Galerkin's method leads to a coupled system of linear algebraic equations. Let the solution space consist of all linear combinations of a given set of NURBS functions $N_A : \hat{\Omega} \rightarrow \mathbb{R}$, where $A = 1, \dots, n_{np}$. Without loss of generality, we may assume a numbering for these functions such that there exists an integer $n_{eq} < n_{np}$ such that

$$N_A|_{\Gamma_D} = 0 \quad \forall A = 1, \dots, n_{eq}. \quad (17)$$

Thus, for all $w^h \in \mathcal{V}^h$, there exist constants c_A , $A = 1, \dots, n_{eq}$ such that

$$w^h = \sum_{A=1}^{n_{eq}} N_A c_A. \quad (18)$$

Furthermore, the function g^h (frequently called a "lifting") is given similarly by coefficients g_A , $A = 1, \dots, n_{np}$. In practice, we will always choose g^h such that $g_1 = \dots = g_{n_{eq}} = 0$ as they have no effect on its value on Γ_D , and so

$$g^h = \sum_{A=n_{eq}+1}^{n_{np}} N_A g_A. \quad (19)$$

Finally, recalling again (14), for any $u^h \in \mathcal{S}^h$ there exist d_A , $A = 1, \dots, n_{eq}$ such that

$$u^h = \sum_{A=1}^{n_{eq}} N_A d_A + \sum_{B=n_{eq}+1}^{n_{np}} N_B g_B = \sum_{A=1}^{n_{eq}} N_A d_A + g^h. \quad (20)$$

Proceeding to define

$$K_{AB} = a(N_A, N_B), \quad (21)$$

$$F_A = L(N_A) - a(N_A, g^h), \quad (22)$$

and

$$\mathbf{K} = [K_{AB}], \quad (23)$$

$$\mathbf{F} = \{F_A\}, \quad (24)$$

$$\mathbf{d} = \{d_A\}, \quad (25)$$

for $A, B = 1 \dots, n_{eq}$, we can rewrite (16) as the matrix problem

$$\mathbf{Kd} = \mathbf{F}. \quad (26)$$

The matrix \mathbf{K} is commonly referred to as the stiffness matrix, and \mathbf{F} and \mathbf{d} are referred to as the force and displacement vectors, respectively.

It is important to note that \mathbf{K} is a sparse matrix. This is a result of the fact that the support of each basis function is highly localized. Thus, for many combinations of A and B in the $n_{eq} \times n_{eq}$ global stiffness matrix, $K_{AB} = a(N_A, N_B) = 0$. We can take advantage of this fact in order to reduce the amount of work necessary in building and solving the algebraic system. Things are further simplified by employing Gaussian quadrature to perform integrations. This process is detailed in Section 3.3.1 of [12]. Even though the NURBS functions are not necessarily polynomials, Gaussian quadrature seems to be very effective for integrating them. Though this approach to integration is only approximate, it is important to note that integrating the classical polynomial functions by quadrature on elements with curved sides is only an approximation as well.

Once Galerkin's method has been applied and an approximation, u^h , has been obtained, it is fair to inquire as to just how good of an approximation it is. Results for classical FEA and Isogeometric Analysis are discussed in the next session. It turns out that, for elliptic problems such as the one considered in this section, the solution is optimal in a very natural sense; see Chapter 4 of [20].

4. Error Estimates for NURBS

4.1. FEA. Well established *a priori* approximation results exist for classical finite elements applied to elliptic problems (see, for example, the classic text

by [10]). The Sobolev space of order r is defined by

$$H^r(\Omega) = \{\mathbf{u} | D^\alpha \mathbf{u} \in L^2(\Omega), |\alpha| \leq r\}. \quad (27)$$

The norm associated with $H^r(\Omega)$ is given by

$$\|\mathbf{u}\|_r^2 = \sum_{|\alpha| \leq r} \int_{\Omega} (D^\alpha \mathbf{u}) \cdot (D^\alpha \mathbf{u}) \, dx. \quad (28)$$

In classical FEA, the fundamental error estimate for the elliptic boundary value problem, expressed as a bound on the difference between the exact solution, \mathbf{u} , and the FEA solution, \mathbf{u}^h , takes the form

$$\|\mathbf{u} - \mathbf{u}^h\|_m \leq Ch^\beta \|\mathbf{u}\|_r, \quad (29)$$

where $\|\cdot\|_m$ and $\|\cdot\|_r$ are the norms corresponding to Sobolev spaces $H^m(\Omega)$ and $H^r(\Omega)$, respectively, h is a characteristic length scale related to the size of the elements in the mesh, $\beta = \min(p+1-m, r-m)$ where p is the polynomial order of the basis, and C is a constant that does not depend on \mathbf{u} or h .

The term of interest in (29) is h^β . The mesh parameter, h , can be defined in several ways, with the specific definition affecting C . A fairly general definition is the diameter of the smallest circle (in two dimensions) or sphere (in three dimensions) that is large enough to circumscribe any element in the mesh. The **order of convergence**, β , expresses how the error changes under refinement of the mesh. In particular, if we use h -refinement to bisect each of the elements in the mesh (*i.e.*, h is replaced with $h/2$), we would expect the error to decrease by a factor of $(1/2)^\beta$.

4.2. NURBS. The extremely technical details of the process of obtaining a result analogous to (29) for NURBS can be found in [3]. Here we present the basic ideas, but encourage the interested reader to consult the original publication.

For classical FEA polynomials, the result in (29) is obtained by first establishing the interpolation properties of the basis. Let Π_m be the projection operator from $H^m(\Omega)$ into the space spanned by the FEA basis. Then the optimal interpolate is the function

$$\eta^h = \Pi_m u \quad (30)$$

such that

$$\|u - \eta^h\|_m \leq \|u - v^h\|_m \quad \forall v^h \in \mathcal{S}^h, \quad (31)$$

where \mathcal{S}^h is the finite element space. To establish just how good this optimal approximation is (*i.e.*, to determine how can $\|u - \eta^h\|_m$ be bounded), we obtain a bound on each element, and then sum over all of the elements to get a global result. With this interpolation result in hand, the second step in the process is

to relate the result of the Galerkin finite element method, u^h , to the optimal interpolate, η^h . In particular, it can be shown that the order of convergence of the finite element solution is the same as for the optimal interpolate. Taken together, these two results yield the bound (29), which states that (up to a constant) Galerkin's method gives us the optimal result.

When we seek an analogous result for NURBS, we face several difficulties. The first is that the approximation properties of this rational basis are harder to determine than are those of a standard polynomial basis. In particular, note that the weights are determined by the geometry and so are out of our control when we attempt to approximate a field over that geometry and cannot be adjusted to improve the result. The second difficulty originates from the large support of the spline functions. Standard interpolation estimates seek to find a best fit within each element and then aggregate these results to obtain an approximation over the entire domain. This is non-trivial with the spline functions because the support of each function spans several elements, and so we cannot determine optimal values for the control variables by looking at each element individually. The issue is further complicated by the possibility of differing levels of continuity (and thus differing sizes of the supports of the functions) throughout the domain.

To overcome the fact that the basis is rational rather than polynomial, we first note that the parameter space $\hat{\Omega}$ can be considered to be the unit cube $[0, 1]^d$. No generality is lost in this assumption as dividing a knot vector by a constant or adding a constant does not change the resulting physical domain in any way. Let us first denote a NURBS basis function as:

$$R_i(\xi) = \frac{N_i(\xi)w_i}{W(\xi)}, \quad (32)$$

with

$$W(\xi) = \sum_{i=1}^n N_i(\xi)w_i \quad (33)$$

where N_i is the corresponding B-spline basis function. The important thing to note is that the weighting function³, $W(\xi)$, does not change as we h -refine the mesh (it does not change under p -refinement either, though this is not the case we are interested in at present). While both the weights and the basis functions change, they do so in such a way as to leave $W(\xi)$ unaltered. Similarly, the geometrical mapping from the parameter space into the physical space, $\mathbf{F} : \hat{\Omega} \rightarrow \Omega$, does not change as we insert new knot values. See Figure 5. It remains exactly the same at all levels of refinement. To take advantage of this fact, we consider the function we wish to approximate, $u : \Omega \rightarrow \mathbb{R}^\ell$. As the geometrical mapping is one-to-one, we can pull this back to the parametric

³Do not confuse this use of the term "weighting function" with the unrelated use of the same terminology in Galerkin's method.

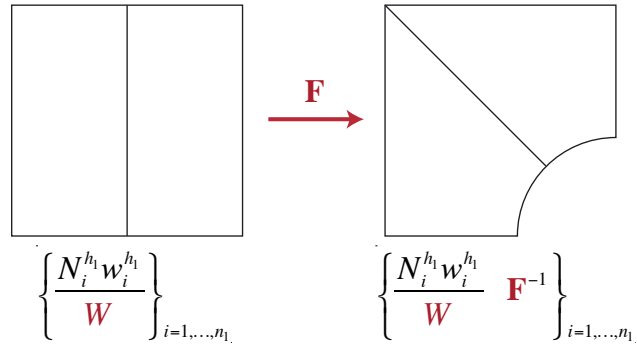

(a) Coarse mesh

(b) First h -refinement(c) Second h -refinement

Figure 5. As we h -refine the mesh, the basis functions N_i and weights w_i change, but the geometrical mapping \mathbf{F} and the weighting function W are *completely fixed* at the coarsest level of discretization. They do not change under refinement.

domain to define $\hat{u} = u \circ \mathbf{F}^{-1} : \hat{\Omega} \rightarrow \mathbb{R}^\ell$. Lastly, we can lift the image of the function using the weighting function to define $\tilde{u} = \{W\hat{u}, W\} : \hat{\Omega} \rightarrow \mathbb{R}^{\ell+1}$. Recalling that we obtain the rational basis in \mathbb{R}^d by a projective transformation (equivalent to dividing by W) of a B-spline basis in \mathbb{R}^{d+1} , we see that the ability of the rational NURBS basis to approximate u on Ω is intimately related to the ability of the underlying B-spline basis to approximate \tilde{u} on $\hat{\Omega}$. Thus we have reduced the problem of understanding a rational basis on a general domain to that of understanding a polynomial basis on the unit cube.

The second hurdle is more technical. The fact that each function has support over many elements and that the continuity across the various element boundaries can vary from one boundary to the next greatly complicates matters compared with the classical case. [3] address this difficulty by proving approximation results in so-called “bent” Sobolev spaces in which the continuity varies throughout the domain. A sequence of lemmas is established leading up to an approximation result that includes not only the norm in these bent Sobolev spaces of the function u being approximated, but also the gradient of the mapping, $\nabla \mathbf{F}$. This last term presents no problem because, as already discussed, it does not change as the mesh is refined, and thus does not affect the rate of convergence. The resulting approximation result is: Let k and l be integer indices such that $0 \leq k \leq l \leq p + 1$, and let $u \in H^l(\Omega)$; then

$$\sum_{e=1}^{n_{el}} |u - \Pi_k u|_{H^k(\Omega^e)}^2 \leq C \sum_{e=1}^{n_{el}} h_e^{2(l-k)} \sum_{i=0}^l \|\nabla \mathbf{F}\|_{L^\infty(\mathbf{F}^{-1}(\Omega^e))}^{2(i-l)} |u|_{H^i(\Omega^e)}^2. \quad (34)$$

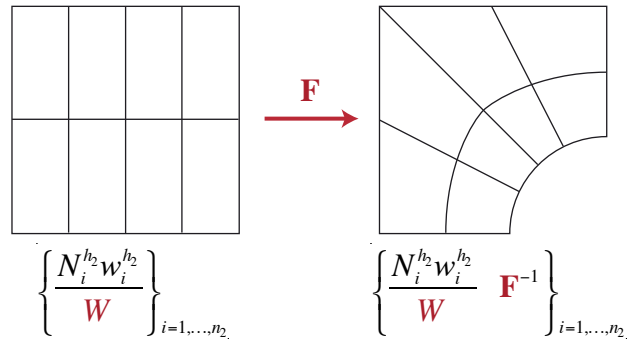
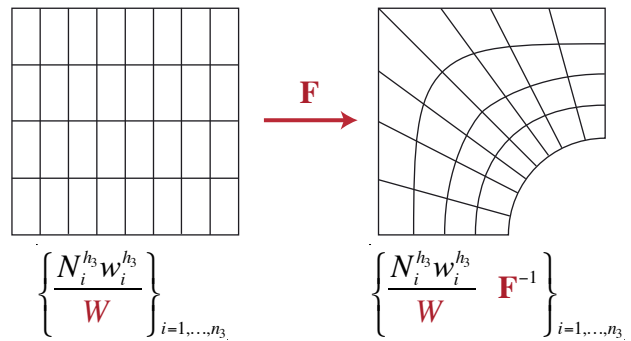
The constant C depends on p and the shape (but not size) of the domain Ω , as well as the shape regularity of the mesh. The factors involving the gradient of the mapping render the estimate dimensionally consistent.

Finally, with the approximation result of (34) in hand, establishing the manner in which the Isogeometric Analysis solution, u^h , relates to the optimal interpolate, η^h , proceeds exactly as in the classical case. Combining these results yields the desired result: *The Isogeometric Analysis solution obtained using NURBS of order p has the same order of convergence as we would expect in a classical FEA setting using classical basis functions with a polynomial order of p .* This is an exceptionally strong result as it is independent of the order of continuity that the mesh possesses. That is, bisecting all of the elements in an FEA mesh (thus cutting the mesh parameter from h to $h/2$) requires the introduction of many more degrees-of-freedom than does bisection of the same number of NURBS elements while maintaining $p - 1$ continuity (see Section 2.1.4 of [12]). This means that NURBS can converge at the same rate as FEA polynomials, while remaining much more efficient.

4.3. Explicit h - k - p -estimates for NURBS. The theoretical study of [3] is continued in [6], focusing on the relation between the degree p and the global regularity k of a NURBS space and its approximation properties. Indeed, error estimates that are explicit in terms of the mesh-size h , and p , k are

obtained. The approach is restricted to C^{k-1} approximations, with $2k - 1 \leq p$. The interesting case of higher regularity, up to $k = p$, is still open. However, the results give an indication of the role of the smoothness k and offer a first mathematical justification of the potential of Isogeometric Analysis based on globally smooth NURBS. The main result, in a simplified form and in the two-dimensional setting, is the following: let v be a function to be approximated. Then there exists a NURBS approximation Πv such that

$$|v - \Pi v|_{H^\ell(\Omega_e)} \leq C(p - k + 1)^{-(\sigma - \ell)} h_e^{\sigma - \ell} \|v\|_{H^\sigma(\Omega_e)} \quad (35)$$

where Ω_e is a mesh element of diameter h_e in the NURBS physical domain Ω , $2k \leq \sigma \leq p + 1$, and $\ell \leq k$. In [6], different asymptotic regimes are studied. In particular, when v is smooth, the strong advantage of higher k is shown.

5. Vibrations

The study of structural vibrations or, more specifically, of eigenvalue problems allows us to examine in more detail the approximation properties of the smooth NURBS functions independently of any geometrical considerations. In general, *spectrum analysis* is the term applied to the study of how numerically computed natural frequencies, ω_n^h , compare with the analytically computed natural frequencies, ω_n . We will see that, for a given number of degrees-of-freedom and bandwidth, the use of NURBS results in dramatically improved accuracy in spectral calculations over classical FEA.

Let us begin by considering one of the simplest vibrational model problems in one dimension: the longitudinal vibrations of an elastic rod. If we consider the domain $\Omega = (0, L) \subset \mathbb{R}$, there is no longer an issue of geometrical accuracy. FEA basis functions and NURBS⁴ are equally capable of representing this domain exactly, and so the quality of the results will depend entirely on the approximation properties of the basis.

To understand the formulation of the eigenproblem representing the longitudinal vibrations of a “fixed-fixed” elastic rod, let us begin by considering the elastodynamics equation from which it is derived. The behavior of the rod, which is assumed to move only in the longitudinal direction, is governed by the equations of linear elasticity combined with Newton’s second law, resulting in

$$(Eu_{,x})_{,x} - \rho u_{,tt} = 0 \quad \text{in} \quad \Omega \times (0, T), \quad (36a)$$

$$u = 0 \quad \text{on} \quad \Gamma \times (0, T), \quad (36b)$$

where $\Omega = (0, L)$, $\rho : (0, L) \rightarrow \mathbb{R}$ is the density per unit length of the rod, $E : (0, L) \rightarrow \mathbb{R}$ is Young’s modulus, and the “fixed-fixed” condition (36b)

⁴In this simple domain, the NURBS reduce to the special case of B-splines.

ensures that the ends of the rod do not move. For an actual dynamics problem, we would need to augment (36) with appropriate initial conditions of the form

$$u(x, 0) = u_0(x), \quad (37)$$

$$u_{,t}(x, 0) = v_0(x). \quad (38)$$

At present, however, we are not interested in the transient behavior of the rod. Instead, we are interested in the natural frequencies and modes in which the rod vibrates. We obtain these by separation of variables. In a slight abuse of notation, we assume $u(x, t)$ to have the form

$$u(x, t) = u(x)e^{i\omega t}, \quad (39)$$

where $u(x)$ is a function of only the spatial variable, x , while $i = \sqrt{-1}$, and ω is the natural frequency. Inserting (39) into (36a) and dividing by the common exponential term results in the eigenproblem we are seeking:

$$(Eu_{,x})_{,x} + \omega^2 \rho u = 0 \quad \text{in } \Omega, \quad (40a)$$

$$u = 0 \quad \text{on } \Gamma. \quad (40b)$$

Equation (40) constitutes an eigenproblem for the rod. The nontrivial solutions are countably infinite. That is, for $k = 1, 2, \dots, \infty$, there is an eigenvalue $\lambda_k = (\omega_k)^2$ and corresponding eigenfunction $u_{(k)}$ satisfying (40). Furthermore, $0 < \lambda_1 \leq \lambda_2 \leq \dots$, and the eigenfunctions are orthogonal. Though the eigenfunctions are only defined up to a multiplicative constant, we can remove the arbitrariness by augmenting the orthogonality condition to include normality.

Following the now familiar process, we multiply (40a) by a test function w and integrate by parts to obtain the weak form of the equation: Find all eigenpairs $\{u, \lambda\}$, $u \in \mathcal{S}$, $\lambda = \omega^2 \in \mathbb{R}^+$, such that for all $w \in \mathcal{V}$

$$a(w, u) - \omega^2 (w, \rho u) = 0, \quad (41)$$

where

$$a(w, u) = \int_0^L w_{,x} E u_{,x} dx, \quad (42)$$

$$(w, \rho u) = \int_0^L w \rho u dx. \quad (43)$$

Note that, due to the homogeneous boundary conditions, $\mathcal{S} = \mathcal{V} = H_0^1(0, L) = \{u \in H^1(0, L) | u(0) = u(L) = 0\}$.

The Galerkin formulation is obtained by restricting ourselves to finite-dimensional subspaces $\mathcal{S}^h \subset \mathcal{S}$ in the usual way. That is, w and u in (41)

will be replaced by finite dimensional approximations w^h and u^h of the form

$$w^h = \sum_{A=1}^{n_{eq}} N_A d_A \quad \text{and} \quad u^h = \sum_{B=1}^{n_{eq}} N_B c_B, \quad (44)$$

respectively. The resulting eigenpairs will contain approximations of both natural modes $u_{(k)}^h$ and the natural frequencies ω_k^h . The problem becomes: Find all $\omega^h \in \mathbb{R}^+$ and $u^h \in \mathcal{S}^h$ such that for all $w^h \in \mathcal{V}^h$

$$a(w^h, u^h) - (\omega^h)^2 (w^h, \rho u^h) = 0. \quad (45)$$

Substituting the shape-function expansions for w^h and u^h in (45) gives rise to a matrix eigenvalue problem: Find natural frequency $\omega_k^h \in \mathbb{R}^+$ and eigenvector Ψ_k , $k = 1, \dots, n_{eq}$, such that

$$(\mathbf{K} - (\omega_k^h)^2 \mathbf{M}) \Psi_k = \mathbf{0}, \quad (46)$$

where

$$\mathbf{K} = [K_{AB}], \quad (47)$$

$$\mathbf{M} = [M_{AB}], \quad (48)$$

with

$$K_{AB} = a(N_A, N_B), \quad (49)$$

$$M_{AB} = (N_A, \rho N_B), \quad (50)$$

and Ψ_k is the vector of control variables corresponding to $u_{(k)}^h$.

As before, we refer to \mathbf{K} as the *stiffness matrix*. The new object, \mathbf{M} , is the *mass matrix*. Noting that $\rho > 0$, and that the NURBS basis functions are pointwise non-negative, we see from (43) that every entry in the mass matrix is also non-negative. This claim cannot be made for standard finite elements.

Let us consider the case where ρ , E , and L are each taken to be 1. Analytically, (40a) can be solved to obtain $\omega_n = n\pi$ for $n = 1, \dots, \infty$. We can assess the quality of the numerical method by comparing the ratio of the computed modes, ω_n^h , with the analytical result. That is, $(\omega_n^h/\omega_n) = 1$ indicates that the numerical frequency is identical to the analytical result. In practice, the discrete frequencies will always obey the relationship

$$\omega_n \leq \omega_n^h \quad \text{for } n = 1, \dots, n_{eq}, \quad (51)$$

and so we expect the ratio (ω_n^h/ω_n) to be greater than 1 (see, *e.g.*, [26]), with larger values indicating decreased accuracy.

Figure 6 shows a comparison of k -method (C^{p-1} p th-order NURBS) and p -method (C^0 p th-order finite elements) numerical spectra for $p = 1, \dots, 4$ (we recall that for $p = 1$ the two methods coincide). Here, the superiority of the isogeometric approach is evident, as one can see that for C^0 finite elements the higher modes *diverge* with p . This negative result shows that even higher-order

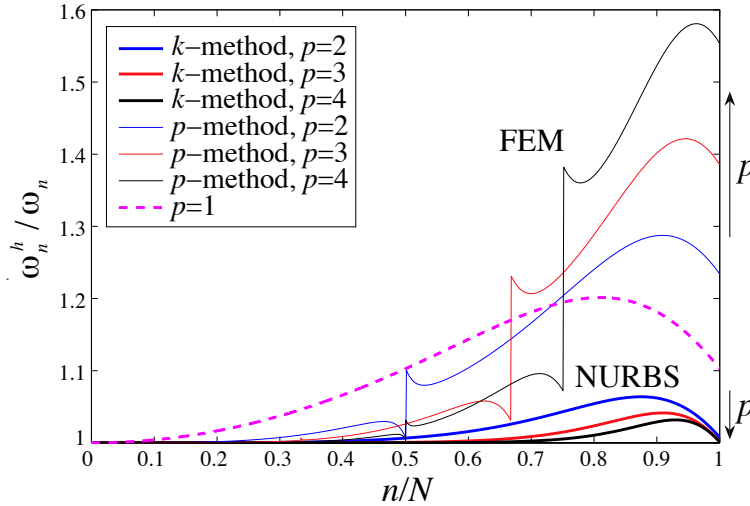

Figure 6. Longitudinal vibrations of an elastic rod. Comparison of k -method and p -method numerical spectra.

finite elements have no approximability for higher modes in vibration analysis, and possibly explains the fragility of higher-order finite element methods in nonlinear and dynamic applications in which higher modes necessarily participate. In contrast, the entire NURBS spectrum converges for all modes. This dramatic result is all the more compelling when we recall that the result is independent of the geometry in this one-dimensional setting. Results such as these can be understood from a more fundamental functional analysis perspective through the notion of Kolmogorov n -widths.

6. Kolmogorov n -widths

The approximation result (34) is a basic tool for proving convergence of NURBS to the solution of partial differential equations with h -refined meshes (see [3] for examples). Note that the continuity of the basis functions does not explicitly appear in (34). Consequently, the order of convergence in (34) depends only on the order of the basis functions employed. However, the results of eigenvalue calculations indicate that there is a dramatic difference between C^0 - and C^{p-1} -continuous p^{th} -order basis functions (see, *e.g.*, Figure 6). In Figure 6, as p is increased, the upper part of the spectrum *diverges* for C^0 -continuous classical finite elements whereas it *converges* for C^{p-1} -continuous NURBS (*i.e.*, B-splines in this case). This phenomenon is not revealed by standard approximation theory results of the form (34). Consequently, we much conclude that there is a lot of information hiding in the so-called “constant” C in (34). Indeed, the refined approximation result (35) illustrates an explicit dependence

of the constant on polynomial order *and* continuity. However, the result is quite limited in its application as it is restricted to C^{k-1} approximations, with $2k - 1 \leq p$.

It would be desirable to develop a mathematical framework that revealed behavior like that seen in Figures 6 from the outset. The concept of Kolmogorov n -widths seems to hold the potential to do so. A sketch of some of the main ideas follows: Let X be a normed, linear space, equipped with norm $\|\cdot\|_X$. In the cases of primary interest here, X would be a Sobolev space. Let X_n be an n -dimensional subspace of X . Assume we wish to approximate a given $x \in A \subset X$, where A is a subset of X , with a member $x_n \in X_n$. We define the *distance* between x and X_n as

$$E(x, X_n; X) = \inf_{x_n \in X_n} \|x - x_n\|_X, \quad (52)$$

where inf stands for infimum (see Figure 7). If there exists an x_n^* such that

$$\|x - x_n^*\|_X = E(x, X_n; X) \quad (53)$$

then x_n^* is called the *best approximation* of x .

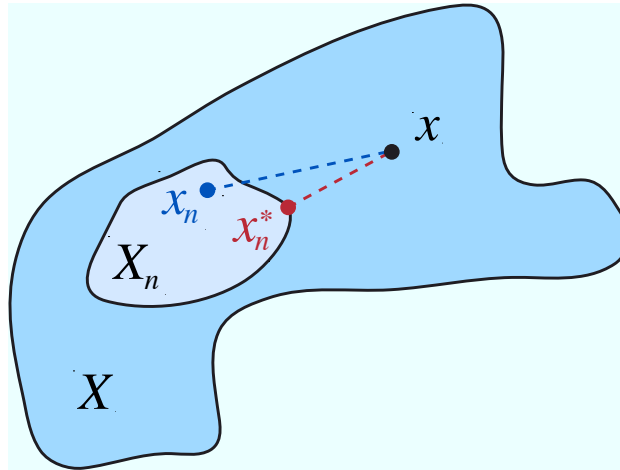

Figure 7. The point x_n^* is the closest approximation in X_n to x with respect to the norm $\|\cdot\|_X$.

Now we assume we are interested in approximating all $x \in A$. For each $x \in A$, the best we can do is expressed by (53). The question we wish to have answered is, for which $x \in A$ do we get the *worst* best-approximation? In other words, for which $x \in A$ is $\inf_{x_n \in X_n} \|x - x_n\|_X$ the largest? The idea is to anticipate situations such as those depicted in Figures 6. The worst best-approximation is obtained by computing the supremum of (53) over all $x \in A$;

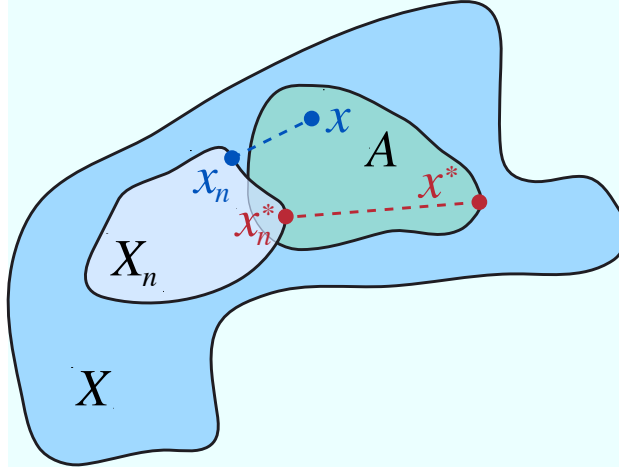

Figure 8. The distance between subspaces X_n and A is determined by the “worst-case scenario.” That is, if the distance between point $x^* \in A$ and its best approximation $x_n^* \in X_n$ is the supremum over all such best-fit pairs, then $\|x^* - x_n^*\|_X$ defines the distance between X_n and A .

we define the *deviation*, or “sup-inf,” as

$$E(A, X_n; X) = \sup_{x \in A} \inf_{x_n \in X_n} \|x - x_n\|_X. \tag{54}$$

See Figure 8 for a schematic illustration. Sup-inf’s are useful for comparing the approximation quality of different finite element subspaces, such as C^0 and C^{p-1} splines, but prior to that we might ask what is the best n -dimensional subspace for approximating A ? This is given by the *Kolmogorov n -width*, or “inf-sup-inf,” namely,

$$d_n(A, X) = \inf_{\substack{X_n \subset X \\ \dim X_n = n}} \sup_{x \in A} \inf_{x_n \in X_n} \|x - x_n\|_X \tag{55}$$

$$= \inf_{\substack{X_n \subset X \\ \dim X_n = n}} E(A, X_n; X). \tag{56}$$

If there exists an \tilde{X}_n such that

$$E(A, \tilde{X}_n; X) = d_n(A, X), \tag{57}$$

then \tilde{X}_n is called an *optimal n -dimensional subspace*. In this case, we can define the *optimality ratio*, that is, the sup-inf divided by the inf-sup-inf, for a given X_n :

$$\Lambda(A, X_n; X) = \frac{E(A, X_n; X)}{d_n(A, X)}. \tag{58}$$

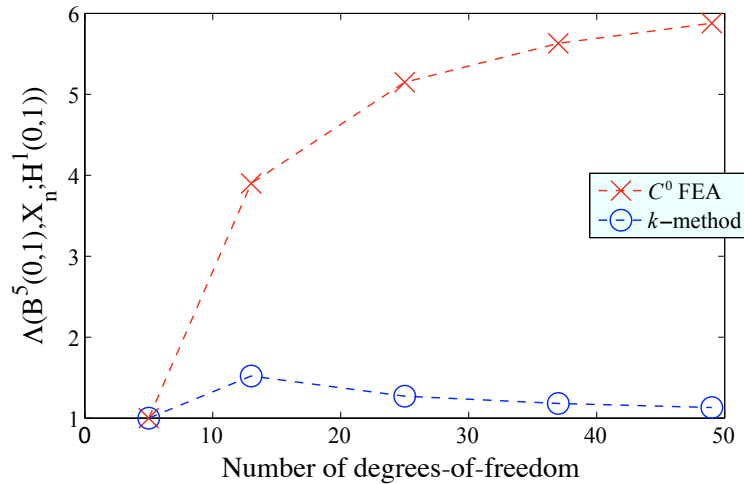

Figure 9. The optimality ratio for approximating the H^5 unit ball in H^1 using quartic ($p = 4$) elements. As the number of degrees-of-freedom increases, the optimality ratio of C^0 FEA functions diverges, while the optimality ratio of C^3 -continuous splines converges toward 1.

To illustrate how one might use this measure for comparing spaces, consider the following example of a uniform mesh on the unit interval $[0, 1]$. Let $X = H^1(0, 1)$, the Sobolev space of square-integrable functions with square-integrable derivatives. Let

$$A = B^5(0, 1) = \{x | x \in H^5(0, 1), \|x\|_X \leq 1\}, \quad (59)$$

where $H^5(0, 1)$ is the Sobolev space of functions having five square-integrable derivatives. $B^5(0, 1)$ is referred to as the unit ball in $H^5(0, 1)$ in the $H^1(0, 1)$ -topology. A comparison of optimality ratios for quartic C^0 and C^3 splines is shown in Figure 9. Note that as n increases, the optimality ratio of the C^3 case approaches 1. Apparently, the C^3 case is converging toward an optimal subspace. In contrast, in the C^0 case, the optimality ratio converges to approximately 5.5, indicating that for each n there is at least one member of $B^5(0, 1)$ that is much more poorly approximated by C^0 splines than C^3 splines. This result seems to be qualitatively consistent with what we saw in Figures 6. Smooth spline bases, that is the k -method, exhibit better behavior than classical C^0 elements. For further results and methodology used to compute them, see [16].

7. Smooth Isogeometric Discretizations

From the mathematical side, one of the most interesting aspects of Isogeometric Analysis is the possibility to have smooth approximation fields. Smooth discrete

spaces can be directly used with partial differential equations of order higher than two. One interesting example is the stream-function approach to the Stokes problem (see [1]). The solution of the Stokes variational equations is the pair⁵ $(\mathbf{u}, p) \in (H_D^1(\Omega))^2 \times L^2(\Omega)$ such that

$$\begin{cases} \int_{\Omega} \mathbf{grad}(\mathbf{u}) : \mathbf{grad}(\mathbf{v}) + \int_{\Omega} p \operatorname{div} \mathbf{v} = \int_{\Omega} \mathbf{f} \cdot \mathbf{v} & \forall \mathbf{v} \in H_D^1(\Omega) \\ \int_{\Omega} q \operatorname{div} \mathbf{u} = 0 & \forall q \in L^2(\Omega), \end{cases} \quad (60)$$

where $H_D^1(\Omega)$ is the Sobolev space of H^1 functions vanishing on $\Gamma_D \subset \partial\Omega$. For two-dimensional problems, the divergence-free field \mathbf{u} can be represented as the **curl** of a potential, the so called *stream function*, that is $\mathbf{u} = \mathbf{curl} \psi$. Since $\operatorname{div}(\mathbf{curl} \psi) = 0$, one can replace (60) with

$$\begin{aligned} \int_{\Omega} \mathbf{grad}(\mathbf{curl} \psi) : \mathbf{grad}(\mathbf{curl} \phi) &= \int_{\Omega} \mathbf{f} \cdot \mathbf{curl} \phi & \forall \phi \in H^2(\Omega) \\ &+ \text{boundary conditions.} \end{aligned} \quad (61)$$

The advantage of the above formulation is that at the discrete level, replacing $H^2(\Omega)$ with a suitable NURBS space with at least global C^1 -continuity, one obtains an approximation $u_h = \mathbf{curl} \psi_h$ which is exactly divergence-free.

The application of this approach to a more realistic problem is presented in [2] where the capability of various numerical methods to correctly reproduce the stability range of finite strain (nonlinear) problems in the incompressible regime is studied. The stream-function isogeometric NURBS approach is applied to a linearized problem at each Newton step of the finite strain problem. This technique is able to sharply estimate the stability limits of the continuous problem in contrast with various standard finite element methods. For example, a simple benchmark problem (an elastic incompressible square in plain strain under constant body load and clamped on three sides) is shown to be stable under compression up to a loading factor of 6.6, while various finite element methods show instabilities around a loading factor of 1.

Another application area where smooth isogeometric discretizations can be utilized is the numerical simulation of phase-field models. Phase-field models provide an alternative description for phase-transition phenomena. The key idea in the phase-field approach is to replace sharp interfaces by thin transition regions where the interfacial forces are smoothly distributed. The transition regions are part of the solution of the governing equations and, thus, front tracking is avoided. Phase-field models are typically characterized by higher-order differential operators and hence require smooth discretization techniques. Isogeometric Analysis has been applied to several phase-field models, including the Cahn-Hilliard equation [18] and the Navier-Stokes-Korteweg equations [19].

⁵Here p is the *pressure* instead of the degree.

8. Vector Field Discretizations

An alternate approach to stream-functions which can also handle problems with a solenoidal constraint is the construction of B-splines or NURBS spaces which fulfill the divergence-free property exactly. This is possible once again due to the smoothness of isogeometric spaces, leading to an extension of classical Raviart-Thomas elements. These new discretizations can be used for a much wider class of problems (*e.g.*, Stokes flow (60)) than classical Raviart-Thomas elements. In [9], smooth Raviart-Thomas B-splines and NURBS spaces are introduced and their study is initiated. In [7], these spaces are used in the simulation of incompressible fluid flows.

The mathematical structure behind the construction in [9] can be understood in the framework of the Exterior Calculus. This has been done in [8] where a De Rham complex for B-spline spaces⁶ is constructed. Notably, there exist B-spline spaces X_h^i , $i = 0, \dots, 3$, of any degree and commuting projectors Π^i , $i = 0, \dots, 3$ such that

$$\begin{array}{ccccccc}
 H^1(\Omega) & \xrightarrow{\text{grad}} & \mathbf{H}(\text{curl}; \Omega) & \xrightarrow{\text{curl}} & \mathbf{H}(\text{div}; \Omega) & \xrightarrow{\text{div}} & L^2(\Omega) \\
 \Pi^0 \downarrow & & \Pi^1 \downarrow & & \Pi^2 \downarrow & & \Pi^3 \downarrow \\
 X_h^0 & \xrightarrow{\text{grad}} & X_h^1 & \xrightarrow{\text{curl}} & X_h^2 & \xrightarrow{\text{div}} & X_h^3.
 \end{array} \quad (62)$$

The above diagram paves the way to stable discretizations of a wide class of differential problems. For example, it provides *spurious free* smooth approximation of the Maxwell eigenproblem: find $\omega \in \mathbb{R}$, and $\mathbf{u} \in \mathbf{H}(\text{curl}; \Omega)$, $\mathbf{u} \neq \mathbf{0}$ such that

$$\int_{\Omega} \text{curl } \mathbf{u} \cdot \text{curl } \mathbf{v} = \omega^2 \int_{\Omega} \mathbf{u} \cdot \mathbf{v} \quad \forall \mathbf{v} \in \mathbf{H}(\text{curl}; \Omega). \quad (63)$$

For more details, see [8].

9. Conclusions

We have presented a brief mathematical introduction to Isogeometric Analysis, a new numerical methodology for solving partial differential equations (PDEs) that combines and synthesizes Computer Aided Design (CAD) and Finite Element Analysis (FEA) technologies. A main motivation of Isogeometric Analysis is to simplify the process of building FEA models from CAD files, a major bottleneck in the overall engineering process. However, Isogeometric Analysis has also provided new insights and methods for solving PDEs. By way of an

⁶Note that these are B-splines and not NURBS.

example, we have shown that Isogeometric Analysis can provide more accurate solutions of PDEs than classical C^0 -continuous finite elements. However, these differences are not revealed by standard error analysis procedures utilizing functional analysis techniques in that they are rather insidiously hidden in “constants” in functional analysis inequalities. The example also illustrates a striking deficiency of classical, higher-order, C^0 -continuous finite elements, namely, the errors in higher modes diverge with increasing polynomial order. This surprising result seems to explain the observed fragility of these finite element spaces when used to obtain the solution of nonlinear problems, which often involve higher-mode behavior. We also reported on initial investigations using Kolmogorov n -widths to computationally determine the relative merits of finite-dimensional approximating spaces. This amounts to an *a priori* approach capable of exposing deficiencies of approximating spaces for computing the solutions of PDEs.

We have also noted that the smooth, higher-order basis functions of Isogeometric Analysis open the way to efficiently solving higher-order PDEs on complex domains. Problems of this kind, such as those representing multi-phase phenomena, have proven very difficult for standard FEA approaches. Finally, we briefly reviewed recent mathematical work in Isogeometric Analysis devoted to the construction of smooth, divergence-free, approximating spaces for vector field problems, and mentioned seminal functional analysis results that explicitly reveal the improvements garnered by the smooth approximating spaces used in Isogeometric Analysis.

Acknowledgements

We thank Lourenço Beirão de Veiga, Annalisa Buffa, and Giancarlo Sangalli for providing us with a summary of their most recent results that we have included herein. T.J.R. Hughes was partially supported by the Office of Naval Research under Contract Number N00014-08-0992 and by the National Science Foundation under NSF Grant Number 0700204. J.A. Evans was partially supported by the Department of Energy Computational Science Graduate Fellowship, provided under Grant Number DE-FG02-97ER25308.

References

- [1] F. Auricchio, L. Beirão de Veiga, A. Buffa, C. Lovadina, and A. Reali, *A fully “locking-free” isogeometric approach for plane elasticity problems: A stream-function formulation*, Computer Methods in Applied Mechanics and Engineering, 197, (2007) 160–172.
- [2] F. Auricchio, L. Beirão de Veiga, C. Lovadina, and A. Reali, *The importance of the exact satisfaction of the incompressibility constraint in nonlinear elastic-*

- ity: Mixed FEMs versus NURBS-based approximations*, Computer Methods in Applied Mechanics and Engineering, 199, (2010) 314–323.
- [3] Y. Bazilevs, L. Beirão de Veiga, J.A. Cottrell, T.J.R. Hughes, and G. Sangalli, *Isogeometric analysis: approximation, stability, and error estimates for h-refined meshes*, Mathematical Models and Methods in Applied Sciences, 16, (2006) 1031–1090.
- [4] Y. Bazilevs, V.M. Calo, J.A. Cottrell, J.A. Evans, T.J.R. Hughes, S. Lipton, M.A. Scott, and T.W. Sederberg, *Isogeometric analysis using T-splines*, Computer Methods in Applied Mechanics and Engineering, 199, (2010) 229–263.
- [5] Y. Bazilevs, V.M. Calo, Y. Zhang, and T.J.R. Hughes, *Isogeometric fluid-structure interaction analysis with applications to arterial blood flow*, Computational Mechanics, 38, (2006) 310–322.
- [6] L. Beirão da Veiga, A. Buffa, J. Rivas, and G. Sangalli, *Some estimates for h-p-k-refinement in isogeometric analysis*, Technical report, IMATI-CNR Preprint, 2009.
- [7] A. Buffa, C. De Falco, and G. Sangalli, *Isogeometric analysis: New stable elements for the Stokes equation*, Technical Report, IMATI-CNR Preprint, 2010.
- [8] A. Buffa, J. Rivas G. Sangalli, and R. Vázquez, *Isogeometric analysis in electromagnetics: Theory and Testing*, Technical Report, IMATI-CNR Preprint, 2010.
- [9] A. Buffa, G. Sangalli, and R. Vázquez, *Isogeometric analysis in electromagnetics: B-splines approximation*, Computer Methods in Applied Mechanics and Engineering, 199, (2010) 1143–1152.
- [10] P.G. Ciarlet, *The Finite Element Method for Elliptic Problems*, North-Holland, 1978.
- [11] E. Cohen, R.F. Reisenfeld, and F. Elber, *Geometric Modeling with Splines: An Introduction*, A.K. Peters, Ltd., 2001.
- [12] J.A. Cottrell, T.J.R. Hughes, and Y. Bazilevs, *Isogeometric Analysis: Toward Integration of CAD and FEA*, Wiley, 2009.
- [13] J.A. Cottrell, T.J.R. Hughes, and A. Reali, *Studies of refinement and continuity in isogeometric analysis*, Computer Methods in Applied Mechanics and Engineering, 196, (2007) 4160–4183.
- [14] J.A. Cottrell, A. Reali, Y. Bazilevs, and T.J.R. Hughes, *Isogeometric analysis of structural vibrations*, Computer Methods in Applied Mechanics and Engineering, 195, (2006) 5257–5296.
- [15] M.R. Dorfel, B. Juttler, and B. Simeon, *Adaptive isogeometric analysis by local h-refinement with T-splines*, Computer Methods in Applied Mechanics and Engineering, 199, (2010) 264–275.
- [16] J.A. Evans, Y. Bazilevs, I. Babuška, and T.J.R. Hughes, *n-widths, sup-infs, and optimality ratios for the k-version of the isogeometric finite element method*, Computer Methods in Applied Mechanics and Engineering, 198, (2009) 1726–1741.
- [17] G.E. Farin, *NURBS Curves and Surfaces: From Projective Geometry to Practical Use*, A.K. Peters, Ltd., 1999.

-
- [18] H. Gomez, V.M. Calo, Y. Bazilevs, and T.J.R. Hughes, *Isogeometric analysis of the Cahn-Hilliard phase-field model*, Computer Methods in Applied Mechanics and Engineering, 197, (2008) 4333–4352.
- [19] H. Gomez, T.J.R. Hughes, X. Noguera, and V.M. Calo, *Isogeometric analysis of the isothermal Navier-Stokes-Korteweg equations*, Computer Methods in Applied Mechanics and Engineering, 199, (2010) 1828–1840.
- [20] T.J.R. Hughes, *The Finite Element Method: Linear Static and Dynamic Finite Element Analysis*, Dover, 2000.
- [21] T.J.R. Hughes, J.A. Cottrell, and Y. Bazilevs, *Isogeometric analysis: CAD, finite elements, NURBS, exact geometry and mesh refinement*, Computer Methods in Applied Mechanics and Engineering, 194, (2005) 4135–4195.
- [22] L. Piegl and W. Tiller, *The NURBS Book (Monographs in Visual Communication), Second Edition*, Springer-Verlag, 1997.
- [23] D.F. Rogers, *An Introduction to NURBS with Historical Perspective*, Academic Press, 2001.
- [24] T.W. Sederberg, D.L. Cardon, G.T. Finnigan, N.S. North, J.M. Zheng, and T. Lyche, *T-spline simplification and local refinement*, ACM Transactions on Graphics, 23, (2004) 276–283.
- [25] T.W. Sederberg, J.M. Zheng, A. Bakenov, and A. Nasri, *T-splines and T-NURCCs*, ACM Transactions on Graphics, 22, (2003) 477–484.
- [26] G. Strang and G.J. Fix, *An Analysis of the Finite Element Method*, Prentice-Hall, 1973.
- [27] T-Splines, Inc. <http://www.tsplines.com/maya/> (2010).
- [28] T-Splines, Inc. <http://www.tsplines.com/rhino/> (2010).

Recent Developments on the Global Behavior to Critical Nonlinear Dispersive Equations

Carlos E. Kenig*

Abstract

We will discuss some recent developments in the area of non-linear dispersive and wave equations, concentrating on the long time behavior of solutions to critical problems. The issues that arise are global well-posedness, scattering and finite time blow-up. In this direction we will discuss a method to study such problems (which we call the “concentration compactness/rigidity theorem” method) developed by the author and Frank Merle. The ideas used here are natural extensions of the ones used earlier, by many authors, to study critical non-linear elliptic problems, for instance in the context of the Yamabe problem and in the study of harmonic maps. They also build on earlier works on energy critical defocusing problems. Elements of this program have also proved fundamental in the determination of “universal profiles” at the blow-up time. This has been carried out in recent works of Duyckaerts, the author and Merle. The method will be illustrated with concrete examples, from works of several authors.

Mathematics Subject Classification (2010). 35L70, 35Q55

In the last 25 years or so, there has been considerable interest in the study of non-linear partial differential equations, modeling phenomena of wave propagation, coming from physics and engineering. The areas that gave rise to these equations are water waves, optics, lasers, ferromagnetism, general relativity and many others. These equations have also connections to geometric flows, and Minkowski and Kähler geometries. Examples of such equations are the generalized KdV equations

$$\begin{cases} \partial_t u + \partial_x^3 u + u^k \partial_x u = 0, & x \in \mathbb{R}, t \in \mathbb{R} \\ u|_{t=0} = u_0 \end{cases}, \quad (1)$$

*Department of Mathematics, University of Chicago, Chicago, IL 60637, USA. E-mail: cek@math.uchicago.edu

the non-linear Schrödinger equations:

$$\begin{cases} i\partial_t u + \Delta u + |u|^p u = 0 & x \in \mathbb{R}^N, t \in \mathbb{R} \\ u|_{t=0} = u_0 \end{cases} \quad (2)$$

and the non-linear wave equation

$$\begin{cases} \partial_t^2 u - \Delta u = |u|^p u & (x, t) \in \mathbb{R}^N \times \mathbb{R} \\ u|_{t=0} = u_0 \\ \partial_t u|_{t=0} = u_1 \end{cases} . \quad (3)$$

Inspired by the theory of ordinary differential equations, one defines a notion of well-posedness for these initial value problems, with data u_0 in a given function space B . Since these equations are time-reversible, the intervals of time to be considered are symmetric around the origin. Well-posedness entails existence, uniqueness of a solution, which describes a continuous curve in the space B , for $t \in I$, the interval of existence, and continuous dependence of this curve on the initial data. If I is finite, we call this local well-posedness, if I is the whole line, we call this global well-posedness. The first stage of development of the theory concentrated on what I will call the “local theory of the Cauchy problem”, which established local well-posedness results on Sobolev spaces B , or global well-posedness for small data in B . Pioneering works were due to Sigal [Si], Strichartz [Str], Kato [Ka1, Ka2], Ginibre–Velo [GV1], Pecher [P], Tsutsumi [Ts] and many others. In the late 80’s, in collaboration with Ponce and Vega (see [KPV1, KPV2], etc.) we introduced the systematic use of the machinery of modern harmonic analysis to study the “local theory of the Cauchy problem”. Further contributions came from work of Bourgain ([B1, B2], etc.) and Klainerman–Machedon ([KlM], etc.), Tataru ([Tat1, Tat2], etc.), Tao ([T4, T5], etc.) and many others. The resulting body of techniques has proved very powerful in many problems and has attracted the attention of a large community of researchers.

In recent years, there has been a great deal of interest in the study, for non-linear dispersive equations, of the long-time behavior of solutions, for large data. Issues like blow-up, global existence and scattering have come to the forefront, especially in critical problems. These problems are natural extensions of non-linear elliptic problems which were studied earlier. To explain this connection, recall that in the late 1970’s and early 1980’s, there was a great deal of interest in the study of semi-linear elliptic equations, to a great degree motivated by geometric applications. For instance, recall the Yamabe problem: let (M, g) be a compact Riemannian manifold of dimension $N \geq 3$. Is there a conformal metric $\tilde{g} = cg$, so that the scalar curvature of (M, \tilde{g}) is constant? In this context, the equation $(\Delta u = \sum_{j=1}^N \frac{\partial^2 u}{\partial x_j^2})$ for $x \in \mathbb{R}^N$

$$\Delta u + |u|^{\frac{4}{N-2}} u = 0, \quad (4)$$

where $u \in \dot{H}^1(\mathbb{R}^N) = \{u : \nabla u \in L^2(\mathbb{R}^N)\}$ was extensively studied. Using this information, Trudinger, Aubin and Schoen solved the Yamabe problem in

the affirmative (see [S] and references therein). The equation (4) is “critical” because the linear part and the non-linear part have the same “strength”, since if u is a solution, so is $\frac{1}{\lambda^{(N-2)/2}} u\left(\frac{x}{\lambda}\right)$. The equation (4) is “focusing”, because the linear part (Δ) and the non-linearity ($|u|^{4/(N-2)}u$) have opposite signs and hence they “fight each other”. The difficulties in the study of (4) come from the “lack of compactness” of the Sobolev embedding:

$$\|u\|_{L^{2^*}(\mathbb{R}^N)} \leq C_N \|\nabla u\|_{L^2(\mathbb{R}^N)}, \quad \frac{1}{2^*} = \frac{1}{2} - \frac{1}{N}, \quad (5)$$

where C_N is the best constant. The only non-zero radial solution of (4) in $\dot{H}^1(\mathbb{R}^N)$ (modulo sign, translation and scaling) and also the only non-negative solution is $W(x) = (1 + |x|^2/N(N-2))^{-(N-2)/2}$ (Gidas–Ni–Nirenberg [GNN]). W is also the unique minimizer in (5) ([Tal]). For the much easier “defocusing problem”

$$\Delta u - |u|^{\frac{4}{N-2}}u = 0, \quad u \in \dot{H}^1(\mathbb{R}^N), \quad (6)$$

it is easy to see that there are no non-zero solutions.

Another much studied elliptic problem, which motivated a lot of research, comes from the study of “harmonic maps”. Let M be a k -dimensional Riemannian manifold. A map $u : \mathbb{R}^N \rightarrow M$ is a “harmonic map” if it is a minimizer of the energy $\int |\nabla u|^2$. If $u \in C^2(\mathbb{R}^N; M)$ is a “harmonic map”, it solves the elliptic system (we view M as embedded in \mathbb{R}^p)

$$\Delta u^i + \Gamma_{jk}^i(u) \frac{\partial u^j}{\partial x_l} \frac{\partial u^k}{\partial x_l} = 0, \quad \text{in } \mathbb{R}^N, \quad (7)$$

where Γ_{jk}^i are the Christoffel symbols of the metric on M . Major concerns were the existence and regularity of solutions and their geometrical significance.

Through the study of (4) and (7) by Talenti, Trudinger, Aubin, Schoen–Uhlenbeck, Sachs–Uhlenbeck, Brézis–Coron, etc. (see [S, BC] and references therein) many important techniques were developed. In particular, through these works, the study of the “defect of compactness” and the “bubble decomposition” were first understood. A systematization was developed through P.L. Lions’ work on concentration-compactness [L] and other works.

I will now try to describe a program (which I call the concentration-compactness/rigidity theorem method) which Frank Merle and I have developed to study such critical evolution problems (See [KM1, KM2, KM3, KM4] and the surveys [K1, K2]). This program was inspired in part by the earlier elliptic theory and by Bourgain’s induction on energy method [B3]. It has antecedents in works of Ghanem–Merle [GM], Martel–Merle [MM1, MM2], etc., and Merle–Raphael [MR1, MR2], etc. It applies to both defocusing cases and (for the first time) also to focusing cases. To illustrate the program, we will concentrate on two examples, the “energy critical” non-linear Schrödinger equation

and non-linear wave equation:

$$(NLS) \quad \begin{cases} i\partial_t u + \Delta u \pm |u|^{4/(N-2)}u = 0 & (x, t) \in \mathbb{R}^N \times \mathbb{R} \\ u|_{t=0} = u_0 \in \dot{H}^1(\mathbb{R}^N) \end{cases} \quad (8)$$

$$(NLW) \quad \begin{cases} \partial_t^2 u - \Delta u = \pm |u|^{4/(N-2)}u & (x, t) \in \mathbb{R}^N \times \mathbb{R} \\ u|_{t=0} = u_0 \in \dot{H}^1(\mathbb{R}^N) \\ \partial_t u|_{t=0} = u_1 \in L^2(\mathbb{R}^N) \end{cases} \quad (9)$$

In both instances, the “−” sign corresponds to the defocusing case, while the “+” sign corresponds to the focusing case. For (8) if u is a solution, so is $\frac{1}{\lambda^{(N-2)/2}}u\left(\frac{x}{\lambda}, \frac{t}{\lambda^2}\right)$, while for (9) if u is a solution, so is $\frac{1}{\lambda^{(N-2)/2}}u\left(\frac{x}{\lambda}, \frac{t}{\lambda}\right)$. Both scalings leave invariant the norm in the energy spaces $\dot{H}^1, \dot{H}^1 \times L^2$, which is why the problems are called “energy critical”. Both problems have “energies” that are constant in time:

$$(NLS) \quad E_{\pm}(u_0) = \frac{1}{2} \int |\nabla u_0|^2 \pm \frac{1}{2^*} \int |u_0|^{2^*} \quad (10)$$

$$(NLW) \quad E_{\pm}(u_0, u_1) = \frac{1}{2} \int |\nabla u_0|^2 + \frac{1}{2} \int (u_1)^2 \pm \frac{1}{2^*} \int |u_0|^{2^*} \quad (11)$$

where +=defocusing case, −=focusing case.

For both problems the “local theory of the Cauchy problem” has been long understood. (For (NLS) through work of Cazenave–Weissler (90) [CW], for (NLW) through works of Pecher (84) [P], Ginibre–Velo (95) [GV2]). These works (say for (NLS)) show that for any $u_0 \in \dot{H}^1(\mathbb{R}^N), \|u_0\|_{\dot{H}^1} < \delta, \exists!$ solution of (NLS), defined for all time, depending continuously on u_0 and which scatters, i.e. $\exists u_0^{\pm} \in \dot{H}^1$ such that

$$\lim_{t \rightarrow \pm\infty} \|u(t) - w_{\pm}(t)\|_{\dot{H}^1} = 0, \quad (12)$$

where w_{\pm} solves the linear problem

$$\begin{cases} i\partial_t w_{\pm} + \Delta w_{\pm} = 0 \\ w_{\pm}|_{t=0} = u_0^{\pm} \end{cases} . \quad (13)$$

Moreover, given any data u_0 in the energy space, there exist $T_{\pm}(u_0)$ such that there exists a unique solution $u \in C((-T_-(u_0), T_+(u_0)); \dot{H}^1)$ and the interval is maximal. Corresponding results hold for (NLW).

The natural conjecture in defocusing cases (when the linear operator and the non-linearity cooperate) is:

(†) Global regularity and well-posedness conjecture: The same global result as above holds for large data, i.e. we have global in time well-posedness

and scattering for arbitrary data in \dot{H}^1 ($\dot{H}^1 \times L^2$), moreover more regular data preserve this regularity for all time.

(\dagger) was first established for (NLW), through work of Struwe (1988) in the radial case [St1], Grillakis (1990) in the general case [Gr] and in this form by Shatah–Struwe (93,94) [SS1], [SS2] and Kapitanski (93) [Kap] and Bahouri–Shatah (98) [BS].

The first progress on (\dagger) for (NLS) was due to Bourgain (99) (radial case $N = 3, 4$) [B3], Tao (05) (radial case $N \geq 5$) [T3], Colliander–Keel–Staffilani–Takaoka–Tao (05) [CKSTT] general case $N = 3$, Ryckman–Vişan (06) $N = 4$ [RV], Vişan (06) $N \geq 5$ [V].

In the focusing case, (\dagger) fails. In fact, for (NLW), H. Levine (1974) [Le] showed that if $(u_0, u_1) \in H^1 \times L^2$, $E(u_0, u_1) < 0$, then $T_{\pm}(u_0, u_1)$ are finite. (This was done through an “obstruction” type of argument). Recently, Krieger–Schlag–Tataru (07) [KST2] constructed explicit radial examples, $N = 3$. For (NLS) a classical argument (first discovered by Zakharov and then independently by Glassey (77) [G]) shows that if $\int |x|^2 |u_0(x)|^2 < \infty$, $u_0 \in \dot{H}^1$, $E(u_0) < 0$, then $T_{\pm}(u_0)$ are finite. Moreover, $W(x) = (1 + |x|^2/N(N-2))^{-(N-2)/2} \in \dot{H}^1$ and is a static solution of (NLS), (NLW) since $\Delta W + |W|^{4/(N-2)}W = 0$. Thus scattering need not happen for global solutions. We now have, for focusing problems:

($\dagger\dagger$) Ground state conjecture: There exists a “ground state”, whose energy is a threshold for global existence and scattering.

The method that Merle and I have developed gives a “road map” to attack (\dagger), ($\dagger\dagger$). Let us illustrate it with ($\dagger\dagger$) for (NLS), (NLW).

Theorem A (Kenig and Merle 06 [KM3]). *For the focusing energy critical (NLS) $3 \leq N \leq 5$, $u_0 \in \dot{H}^1$, radial, such that $E(u_0) < E(W)$, we have:*

- i) If $\|u_0\|_{\dot{H}^1} < \|W\|_{\dot{H}^1}$, the solution exists for all time and scatters*
- ii) If $\|u_0\|_{\dot{H}^1} > \|W\|_{\dot{H}^1}$, $T_{\pm}(u_0) < \infty$*

Theorem B (Kenig and Merle 07 [KM1]). *For the focusing energy critical (NLW), $3 \leq N \leq 5$, $(u_0, u_1) \in \dot{H}^1 \times L^2$, $E(u_0, u_1) < E(W, 0)$, we have*

- i) If $\|u_0\|_{\dot{H}^1} < \|W\|_{\dot{H}^1}$, the solution exists for all time and scatters*
- ii) If $\|u_0\|_{\dot{H}^1} > \|W\|_{\dot{H}^1}$, $T_{\pm}(u_0, u_1) < \infty$*

Remark: There is no radial assumption on Theorem B. Also the case $E(u_0, u_1) < E(W, 0)$, $\|u_0\|_{\dot{H}^1} = \|W\|_{\dot{H}^1}$ is impossible (similarly for (NLS)). This proves ($\dagger\dagger$), the ground state conjecture, for (NLW). It was the first full proof of ($\dagger\dagger$) in a significant example. Killip–Vişan (08) [KV1] have combined

the ideas in Theorem B with another important new idea, to extend Theorem A to the non-radial case $N \geq 5$.

“The road map” (applied to the proof of Theorem B, i)):

a) Variational arguments (Only needed in focusing problems)

These are “elliptic arguments” which come from the characterization of W as the minimizer of $\|u\|_{L^{2^*}} \leq C_N \|\nabla u\|_{L^2}$. They yield that if we fix $\delta_0 > 0$ so that $E(u_0, u_1) < (1 - \delta_0)E(W, 0)$ and if $\|u_0\|_{\dot{H}^1} < \|W\|_{\dot{H}^1}$, $\|u_0\|_{\dot{H}^1} < (1 - \bar{\delta})\|W\|_{\dot{H}^1}$ (energy trapping) and $\int |\nabla u_0|^2 - |u_0|^{2^*} \geq \bar{\delta} \int |\nabla u_0|^2$ (coercivity). From this, using preservation of energy and continuity of the flow we can see that for $t \in (-T_-, T_+) = I$, $E(u(t), \partial_t u(t)) \approx \|(u(t), \partial_t u(t))\|_{\dot{H}^1 \times L^2}^2 \approx \|(u_0, u_1)\|_{\dot{H}^1 \times L^2}^2$, so that $\sup_{t \in I} \|(u(t), \partial_t u(t))\|_{\dot{H}^1 \times L^2} < \infty$. This need not guarantee $I = (-\infty, +\infty)$, since, for instance, the Krieger–Schlag–Tataru [KST2] example has this property.

b) Concentration-compactness procedure If $E(u_0, u_1) < E(W, 0)$, $\|u_0\|_{\dot{H}^1} = \|W\|_{\dot{H}^1}$, by a) $E(u(t), \partial_t u(t)) \approx \|(u_0, u_1)\|_{\dot{H}^1 \times L^2}^2$. Thus, if $E(u_0, u_1)$ is small, by the “local Cauchy problem” we have global existence and scattering. Hence, there is a critical level of energy E_C , $0 < \eta_0 \leq E_C \leq E(W, 0)$ s.t. if $E(u_0, u_1) < E_C$, $\|u_0\|_{\dot{H}^1} < \|W\|_{\dot{H}^1}$, we have global existence and scattering and E_C is optimal with this property. Theorem B i) is the statement $E_C = E(W, 0)$. If $E_C < E(W, 0)$, we reach a contradiction by proving:

Proposition 1 (Existence of critical elements). *There exists $(u_{0,C}, u_{1,C})$ with $E(u_{0,C}, u_{1,C}) = E_C$, $\|u_{0,C}\|_{\dot{H}^1} < \|W\|_{\dot{H}^1}$, such that, either I is finite or, if I is infinite, u_C does not scatter. We call u_C a “critical element”.*

To establish Proposition 1, we need to face the “lack of compactness” and the criticality of the problem. To overcome this we use a “profile decomposition”, which is the analog, for wave and dispersive equation of the elliptic “bubble decomposition”. For the wave equation it was first obtained by Bahouri–Gérard (1999) [BG], while for the 2D Schrödinger equation it was independently obtained by Merle–Vega (1998) [MV].

Proposition 2 (Compactness of critical elements). $\exists \lambda(t) \in \mathbb{R}^+$, $x(t) \in \mathbb{R}^N$, $t \in I$ such that

$$K = \left\{ \left(\frac{1}{\lambda(t)^{(N-2)/2}} u_C \left(\frac{x - x(t)}{\lambda(t)}, t \right), \frac{1}{\lambda(t)^{N/2}} \partial_t u_C \left(\frac{x - x(t)}{\lambda(t)}, t \right) \right) : t \in I \right\}$$

has compact closure in $\dot{H}^1 \times L^2$.

This boils down to the fact that the optimality of E_C forces critical elements to have only 1 “bubble” in their “bubble decomposition”.

Finally, the contradiction comes from:

c) Rigidity Theorem: If \bar{K} is compact (and $E(u_{0,C}, u_{1,C}) < E(W, 0)$, $\|u_{0,C}\|_{\dot{H}^1} < \|W\|_{\dot{H}^1}$), then $(u_{0,C}, u_{1,C}) = (0, 0)$.

c) clearly gives a contradiction since $E(u_{0,C}, u_{1,C}) = E_C \geq \eta_0 > 0$.

The “road map” has already found an enormous range of applicability to previously intractable problems, in work of many researchers. Many more applications are expected. Here is an incomplete list of such applications:

Mass Critical NLS

$$\begin{cases} i\partial_t u + \Delta u \pm |u|^{4/N} u = 0 & (x, t) \in \mathbb{R}^N \times \mathbb{R} \\ u|_{t=0} = u_0, & N \geq 1 \end{cases} \quad (14)$$

The “critical norm” is $\|u_0\|_{L^2(\mathbb{R}^N)}$. The analog of (†) (defocusing case) and (††) (focusing case), where the “threshold” is $\|u_0\|_{L^2} < \|Q\|_{L^2}$, where the ground state $Q \geq 0$ solves $\Delta Q + Q^{1+4/N} = Q$, has been obtained, for $N \geq 2$, in the radial case, in works of Tao, Killip, Viřan, Zhang (2007) [KTV, KVZ, TVZ]. Recently, B. Dodson (2010) [D] established (†) in the non-radial case for $N \geq 3$. The case $N = 1$, (†) $N = 2$ non-radial and (††) $N \geq 2$ are open. All positive results use the “road map”.

Wave maps Consider the system, for $u = (u_1, \dots, u_d)$, $u : \mathbb{R}^{N+1} \rightarrow M \hookrightarrow \mathbb{R}^d$, $\square u = A(u)(Du, Du)$, where $A(u) =$ second fundamental form, $Du = (-\partial_t u, \nabla u)$. The system is obtained from similar considerations as harmonic maps, using the Minkowski metric. The case $N = 2$ is “energy critical”. Consider the targets $M = S^2$ or H^2 . The case $M = S^2$ is “focusing” (even though the energy is positive), while the case $M = H^2$ is “defocusing”. The earlier works dealt with mappings satisfying extra symmetries, for instance radial symmetry or being invariant under the action of S^1 on the target (co-rotational symmetry). For such data, the theory of the “local Cauchy problem”, worked out in [S-TZ], is similar to the one of the semi-linear case mentioned earlier. For general data, the theory of the “local Cauchy problem” is highly non-trivial. The theory was developed by Tataru, Tao ([Tat1, Tat2, T4, T5]) for $M = S^2$ and by Krieger [Kr] for $M = H^2$. The Cauchy problem “in the large” was also first studied in the presence of symmetry, starting with pioneering works of Shatah–Thavildar-Zadeh [S-TZ], Christodoulou–Thavildar-Zadeh [C-TZ1, C-TZ2], who showed, for the case of H^2 , that in the radial case there is global existence and scattering for data of any size. Building upon these works, Struwe [St2, St3] showed that for radial data, when $M = S^2$ there is also global existence and in the co-rotational case, when $M = H^2$, there is global existence while if $M = S^2$, if u is such that $E(u) \leq E(Q)$, where Q is the non-constant harmonic map of least energy, there is also global existence. Recently, examples of Rodnianski–Sterbenz [RS], Krieger–Schlag–Tataru [KST1] and Raphael–Rodnianski [RR] have shown that when $M = S^2$, finite time

blow-up can occur for co-rotational wave maps. Using the “road map”, Côte–Kenig–Merle [CKM] have shown that when $M = S^2$ and u is co-rotational, $E(u) \leq E(Q)$, Q as above, then, in addition, either $u = \pm Q$ or u scatters. This is a strengthened version of (††) for this case.

When $M = H^2$ (defocusing case) Tao ([T1], [T2] etc.), Krieger–Schlag (2009) [KrS] gave a general case (not just co-rotational) proof of (†), using the road map. Using a different approach, specific to wave maps, which exploits the fact that the energy is always positive, Sterbenz–Tataru (2009) [ST1, ST2] also gave a proof of (††) when $M = S^2$, $E(u) < E(Q)$. The study of the case $M = S^2$, $E(u) = E(Q)$ for general wave maps remains open.

Energy supercritical defocusing problems in critical spaces For $N = 3$, consider the defocusing equation

$$\begin{cases} \partial_t^2 u - \Delta u = -|u|^{p-1}u \\ u|_{t=0} = u_0 \\ \partial_t u|_{t=0} = u_1 \end{cases} \tag{15}$$

where $p > 5$, and 5 is the energy critical case. There is a critical space $\dot{H}^{s_p} \times \dot{H}^{s_p-1}$, $s_p = \frac{3}{2} - \frac{2}{p-1}$, $1 < s_p < \frac{3}{2}$. Kenig and Merle [KM4] have shown, using the “road map” that, if $\sup_{t \in I} \|(u(t), \partial_t u(t))\|_{\dot{H}^{s_p} \times \dot{H}^{s_p-1}} < \infty$, (u_0, u_1) radial, $I =$ maximal interval of existence, then u is global in time ($I = (-\infty, +\infty)$) and scatters. This was the first large data, global in time result for the energy supercritical case for (NLW). Following this paper and inspired by it, also following the “road map”, Killip–Viřan wrote three papers on the subject. In [KV2], they proved the corresponding result for the defocusing, energy supercritical non-linear Schrödinger equation in $\mathbb{R}^N \times \mathbb{R}$, $N \geq 5$, in the non-radial case, extending the decay estimate they obtained in the energy critical focusing case ([KV1]). In [KV3] they extended the result in [KM4] for $N = 3$, to the non-radial case. In [KV4] they extended the radial result in [KM4] to $N > 3$, for certain ranges of p , for instance for $N = 4, 5, 6$, they deal with the range $\frac{4}{N-2} + 1 < p < \frac{4}{N-3} + 1$. In the forthcoming paper [KM5], Kenig–Merle have extended the result in [KM4] to any odd dimension, in many cases, including the case $p = 5$ in any dimension, in which the critical space is $\dot{H}^k \times \dot{H}^{k-1}$, $N = 2k + 1$.

These results are analogs of the following one for the Navier–Stokes equation, due to Escauriaza–Seregin–Sverak [ESS]. They consider

$$\begin{cases} \partial_t v_j + \partial_{x_i}(v_i v_j) - \Delta v_j = -\partial_{x_j} p \\ \operatorname{div} v = 0 \\ v|_{t=0} = a, \quad x \in \mathbb{R}^3, t > 0 \end{cases} \tag{16}$$

where $\operatorname{div} a = 0$ in \mathbb{R}^3 . They showed, settling a problem which goes back to Leray, that if $I = (0, T_+)$ is the maximal interval of existence, and v is a solution so that $\sup_{t \in I} \|v(\cdot, t)\|_{L^3_x} < \infty$, then $T_+ = \infty$ and v is smooth and unique. L^3

is a critical space here. In joint work with G. Koch [KK], we have shown that our “road map” yields this result (at least in the case when $L^3(\mathbb{R}^3)$ is replaced by the critical space $\dot{H}^{1/2}(\mathbb{R}^3)$). The “rigidity theorem” is established using backward uniqueness for parabolic equations, which was the main ingredient in the proof of [ESS]. This application shows that the “road map” is also applicable to parabolic problems.

Acknowledgements

Supported in part by NSF Grant DMS-0456583.

References

- [BG] Bahouri, H., Gérard, P. *High frequency approximation of solutions to critical nonlinear wave equations*. Amer. J. Math. **121** (1999), no. 1, 131–175.
- [BS] Bahouri, H., Shatah, J. *Decay estimates for the critical semilinear wave equation*. Ann. Inst. H. Poincaré Anal. Non Linéaire **15** (1998), no. 6, 783–789.
- [B1] Bourgain, J. *Fourier restriction phenomena for certain lattice subsets and applications to nonlinear evolution equations*. Geom. Funct. Anal. **3** (1993), 107–156.
- [B2] Bourgain, J. *Fourier restriction phenomena for certain lattice subsets and applications to nonlinear evolution equations II. The KdV equation*. Geom. Funct. Anal. **3** (1993), 209–262.
- [B3] Bourgain, J. *Global wellposedness of defocusing critical nonlinear Schrödinger equation in the radial case*. J. Amer. Math. Soc. **12** (1999), no. 1, 145–171.
- [BC] Brezis, H., Coron, J.-M. *Convergence of solutions of H -systems or how to blow bubbles*. Arch. Rational Mech. Anal. **89** (1985), no. 1, 21–56.
- [CW] Cazenave, T., Weissler, F. B. *The Cauchy problem for the critical nonlinear Schrödinger equation in H^s* . Nonlinear Anal. **14** (1990), no. 10, 807–836.
- [C-TZ1] Christodoulou, D., Tahvildar-Zadeh, A.S. *On the regularity of spherically symmetric wave maps*. CPAM **46** (1993), 1041–1049.
- [C-TZ2] Christodoulou, D., Tahvildar-Zadeh, A.S. *On the asymptotic behavior of spherically symmetric wave maps*. Duke Math. J. **71** (1993), 31–69.
- [CKSTT] Colliander, J., Keel, M., Staffilani, G., Takaoka, H., Tao, T. *Global well-posedness and scattering for the energy-critical nonlinear Schrödinger equation in \mathbb{R}^3* . Annals of Math. (2) **167** (2008), no. 3, 767–865.
- [CKM] Côte, R., Kenig, C., Merle, F. *Scattering below critical energy for the radial 4D Yang-Mills equation and for the 2D corotational wave map system*. Comm. Math. Phys. **284** (2008), no. 1, 203–225.

- [D] Dodson, B. *Global well-posedness and scattering for the defocusing L^2 critical nonlinear Schrödinger equation when $d \geq 3$* . preprint, arXiv:0912.2467
- [ESS] Escauriaza, L., Serégin, G. A., Sverak, V. *$L_{3,\infty}$ -solutions of Navier-Stokes equations and backward uniqueness*. (Russian) Uspekhi Mat. Nauk **58** (2003), no. 2(350), 3–44, translation in Russian Math. Surveys **58** (2003), no. 2, 211–250.
- [GNN] Gidas, B., Ni, W.M., Nirenberg, L. *Symmetry of positive solutions of nonlinear elliptic equations in \mathbb{R}^n* . In Mathematical Analysis and Applications, Part A, volume 7 of Adv. in Math. Suppl. Stud., pages 369–402, Academic Press, New York, 1981.
- [GV1] Ginibre, J., Velo, G. *On a class of nonlinear Schrödinger equations*. JFA **32** (1979), 1–71.
- [GV2] Ginibre, J., Velo, G. *Generalized Strichartz inequalities for the wave equation*. J. Funct. Anal. **133** (1995), no. 1, 50–68.
- [GM] Glangetas, L., Merle, F. *A geometrical approach of existence of blow-up solutions in H^1 for nonlinear Schrödinger equation*, Publications du Laboratoire d'Analyse Numérique, Université Pierre et Marie Curie, CNRS, December 1995.
- [G] Glassey, R. T. *On the blowing up of solutions to the Cauchy problem for nonlinear Schrödinger equations*. J. Math. Phys. **18** (1977), no. 9, 1794–1797.
- [Gr] Grillakis, M. G. *Regularity and asymptotic behaviour of the wave equation with a critical nonlinearity*. Ann. of Math. (2) **132** (1990), no. 3, 485–509.
- [Ka1] Kato, T. *On the Cauchy problem for the (generalized) Korteweg-de Vries equation*. Stud. Appl. Math. ed. V. Guillemin, Academic Press, 1983, 93–128.
- [Ka2] Kato, T. *On nonlinear Schrödinger equations*. Ann. Inst. H. Poincaré Phys. Théor. **46** (1987), 113–129.
- [Kap] Kapitanski, L. *Global and unique weak solutions of nonlinear wave equations*. Math. Res. Lett. **1** (1994) 211–223.
- [K1] Kenig, C. *The concentration-compactness/rigidity theorem method for critical dispersive and wave equations*, 2008, preprint, lectures for a course given at CRM, Bellaterra, Spain, May 2008. Available at <http://www.math.uchicago.edu/~cek>
- [K2] Kenig, C. *Global well-posedness and scattering for the energy critical focusing nonlinear Schrödinger and wave equations*. Lecture notes for a mini course given at “Analyse des équations aux dérivées partielles”, Evian-les-Bains, 2007, available at <http://www.math.uchicago.edu/~cek>.
- [KK] Kenig, C., Koch, G. *An alternative approach to regularity for the Navier-Stokes equation in a critical space*. preprint, arXiv:0908.3349.
- [KM1] Kenig C., Merle F. *Global well-posedness, scattering and blow-up for the energy critical focusing non-linear wave equation*. Acta Math. **201** (2008), no. 2, 147–212

- [KM2] Kenig C., Merle F. *Scattering for $\dot{H}^{1/2}$ bounded solutions to the cubic defocusing NLS in 3 dimensions.* Trans. Amer. Math. Soc. **362** (2010), 1937–1962
- [KM3] Kenig, C., Merle, F. *Global well-posedness, scattering and blow-up for the energy-critical, focusing, non-linear Schrödinger equation in the radial case.* Invent. Math. **166** (2006), no. 3, 645–675.
- [KM4] Kenig, C., Merle, F. *Nondispersive radial solutions to energy supercritical non-linear wave equations, with applications,* preprint, 2008, arXiv:0810.4834v2, To appear Am. J. of Math.
- [KM5] Kenig, C., Merle, F. *Radial solutions to energy supercritical wave equations in all odd dimensions.* in preparation.
- [KPV1] Kenig, C., Ponce, G., Vega, L. *Well-posedness and scattering results for the generalized Korteweg–de Vries equation via the contraction principle.* CPAM **46** (1993), 527–620.
- [KPV2] Kenig, C., Ponce, G., Vega, L. *Small solutions to nonlinear Schrödinger equations.* Ann. Inst. H. Poincaré **110** (1993), 255–288.
- [KTV] Killip, R., Tao, T., Vişan, M. *The cubic nonlinear Schrödinger equation in two dimensions with radial data,* 2007, preprint, arXiv:math.AP/0707.3188.
- [KVZ] Killip, R., Vişan, M., Zhang, X. *The mass-critical nonlinear Schrödinger equation with radial data in dimensions three and higher,* Anal. PDE **1** (2008), no. 2, 229–266
- [KV1] Killip, R., Vişan, M. *The focusing energy-critical nonlinear Schrödinger equation in dimensions five and higher,* 2008, preprint, arXiv:math.AP/0804.1018.
- [KV2] Killip, R., Vişan, M. *Energy supercritical NLS: critical H^s bounds imply scattering.* preprint, arXiv:0812.2084.
- [KV3] Killip, R., Vişan, M. *The defocusing energy-supercritical nonlinear wave equation in three space dimensions.* preprint, arXiv:1001.1761.
- [KV4] Killip, R., Vişan, M. *The radial defocusing energy-supercritical nonlinear wave equation in all space dimensions.* preprint, arXiv:1002.1756.
- [KIM] Klainerman, S., Machedon, M. *Space-time estimates for null forms and the local existence theorem.* CPAM **46** (1993), 1221–1268.
- [Kr] Krieger, J. *Global regularity of wave maps from \mathbb{R}^{2+1} to H^2 . Small energy.* CMP **250** (2004), 507–580.
- [KrS] Krieger, J., Schlag, W. *Concentration compactness for critical wave maps.* preprint, arXiv:0908.2474.
- [KST1] Krieger, J., Schlag, W., Tataru, D. *Renormalization and blow up for charge one equivariant critical wave maps.* Invent. Math. **171** (2008), no. 3, 543–615.
- [KST2] Krieger, J., Schlag, W., Tataru, D. *Slow blow-up solutions for the $H^1(\mathbb{R}^3)$ critical focusing semi-linear wave equation in \mathbb{R}^3 ,* Duke Math. J. **147** (2009), no.1, 1–53.

- [Le] Levine, H.A. *Instability and nonexistence of global solutions to nonlinear wave equations of the form $Pu_t = -Au + \mathcal{F}(u)$* . TAMS **192** (1974), 1–21.
- [L] Lions, P.-L. *The concentration-compactness principle in the calculus of variations. The limit case. II*. Rev. Mat. Iberoamericana **1** (1985), no. 2, 45–121.
- [MM1] Martel, Y., Merle, F. *Liouville theorem for the critical generalized Korteweg–de Vries equation*. J. Math. Pures. Appl. **9** (2000), 339–425.
- [MM2] Martel, Y., Merle, F. *Stability of blow-up profile and lower bounds for the blow-up rate for the critical generalized KdV equation*. Ann. of Math. **155** (2002), 235–280.
- [MR1] Merle, F., Raphael, P. *On universality of blow-up profile for L^2 critical nonlinear Schrödinger equation*. Invent. Math. **156** (2004), 565–672.
- [MR2] Merle, F., Raphael, P. *Profiles and quantization of the blow-up mass for critical nonlinear Schrödinger equation*. CMP **253** (2005), 675–704.
- [MV] Merle, F., Vega, L. *Compactness at blow-up time for L^2 solutions of the critical nonlinear Schrödinger equation in 2D*. Internat. Math. Res. Notices **1998**, no. 8, 399–425.
- [P] Pecher, H. *Nonlinear small data scattering for the wave and Klein-Gordon equation*. Math. Z. **185** (1984), no. 2, 261–270.
- [RR] Raphael, P., Rodnianski, I. *Stable blow-up dynamics for the critical corotational Wave Maps and equivariant Yang–Mills problems*. preprint, arXiv:0911.0692.
- [RS] Rodnianski, I., Sterbenz, J. *On the formation of singularities in the critical $O(3)$ σ -model*. preprint, arXiv:0605023, to appear, Ann. of Math.
- [RV] Ryckman, E., Viřan, M. *Global well-posedness and scattering for the defocusing energy-critical nonlinear Schrödinger equation in \mathbb{R}^{1+4}* . Amer. J. Math. **129** (2007), no. 1, 1–60.
- [S] Schoen, R. *Recent progress in geometric partial differential equations*, Proceedings of ICM, Berkeley, Ca, 1986, Vol. 1, 121–130.
- [SS1] Shatah, J., Struwe, M. *Well-posedness in the energy space for semilinear wave equations with critical growth*. Internat. Math. Res. Notices **1994**, no. 7, 303ff., approx. 7 pp. (electronic).
- [SS2] Shatah, J., Struwe, M. *Geometric wave equations*. Courant Lecture Notes in Mathematics, 2. New York University, Courant Institute of Mathematical Sciences, New York, American Mathematical Society, Providence, RI, 1998. viii+153 pp. ISBN: 0-9658703-1-6, 0-8218-2749-9
- [S-TZ] Shatah, J., Tahvildar-Zadeh, A.S. *On the Cauchy problem for equivariant wave maps*. CPAM **47** (1994), 719–754.
- [Si] Sigal, I. *Space-time decay for solutions of wave equation*. Advances in Math. **22** (1976), 305–311.
- [ST1] Sterbenz, J., Tataru, D. *Regularity of Wave-maps in dimension $2 + 1$* . preprint, arXiv:0907.3148.
- [ST2] Sterbenz, J., Tataru, D. *Energy dispersed large data wave maps in $2 + 1$ dimensions*. preprint, arXiv:0906.3384.

- [Str] Strichartz, R. *Restrictions of Fourier transforms to quadratic surfaces and decay of solutions of wave equations*. Duke Math. J. **44** (1977), 705–714.
- [St1] Struwe, M. *Globally regular solutions to the u^5 Klein-Gordon equation*. Ann. Scuola Norm. Sup. Pisa Cl. Sci. (4) **15** (1988), no. 3, 495–513 (1989).
- [St2] Struwe, M. *Equivariant wave maps in two space dimensions*. Dedicated to the memory of Jürgen K. Moser. Comm. Pure Appl. Math. **56** (2003), no. 7, 815–823.
- [St3] Struwe, M. *Radially symmetric wave maps from $(1 + 2)$ dimensional Minkowski space to the sphere*. Math. Z. **242** (2002), 407–414.
- [Tal] Talenti, G. *Best constant in Sobolev inequality*. Ann. Mat. Pure Appl. **4** (1976), 353–372.
- [T1] Tao, T. *Global regularity of wave maps III. Large energy from \mathbb{R}^{1+2} to hyperbolic spaces*, preprint, 2008, arXiv:math.AP/0805.4666v1.
- [T2] Tao, T. *Global regularity of wave maps IV. Absence of stationary or self-similar solutions in the energy class*, preprint, 2008, arXiv:math.AP/0806.3592.
- [T3] Tao, T. *Global well-posedness and scattering for the higher-dimensional energy-critical nonlinear Schrödinger equation for radial data*. New York J. Math. **11** (2005), 57–80 (electronic).
- [T4] Tao, T. *Global regularity of wave maps I. Small critical Sobolev norm in high dimension*. IMRN **2001** (2001), 299–328.
- [T5] Tao, T. *Global regularity of wave maps II. Small energy in two dimensions*. CMO **224** (2001), 443–544.
- [TVZ] Tao, T., Vişan, M., Zhang, X. *Global well-posedness and scattering for the defocusing mass-critical nonlinear Schrödinger equation for radial data in high dimensions*. Duke Math. J. **140** (2007), no. 1, 165–202.
- [Tat1] Tataru, D. *Local and global results for wave maps I*. Comm. PDE **23** (1998), 1781–1793.
- [Tat2] Tataru, D. *On global existence and scattering for the wave maps equation*. Amer. J. Math. **123** (2001), 37–77.
- [Ts] Tsutsumi, Y. *L^2 solutions for nonlinear Schrödinger equations and nonlinear group*. Funkcial. Ekvac. **30** (1987), 115–125.
- [V] Vişan, M. *The defocusing energy-critical nonlinear Schrödinger equation in higher dimensions*. Duke Math. J. **138** (2007), no. 2, 281–374.

Arithmetic of Linear Algebraic Groups over Two-dimensional Fields

R. Parimala*

Abstract

In 1962 Serre posed a conjecture, now referred to as Conjecture II, which states that principal homogeneous spaces under semisimple simply connected linear algebraic groups over perfect fields of cohomological dimension two have rational points. In this talk, after summarising the status of Conjecture II, we shall discuss progress concerning the study of principal homogeneous spaces under linear algebraic groups over function fields of two-dimensional schemes: surfaces over algebraically closed fields, strict Henselian two dimensional local domains and arithmetic surfaces that are relative curves over p -adic integers.

Mathematics Subject Classification (2010). Primary 11E72, 20G15; Secondary 14G05, 20G35.

Keywords. Linear algebraic groups, Galois Cohomology, Conjecture II, Hasse principle

Introduction

In the sixties, Kneser posed the Hasse Principle conjecture ([Kn3]): a principal homogeneous space under a semisimple simply connected linear algebraic group over a number field has a rational point provided it has a rational point over every real completion. In the case of p -adic fields, Kneser had proved ([Kn1]) that every principal homogeneous space under a semisimple simply connected linear algebraic group has a rational point. A classification free proof is due to Bruhat-Tits ([BT]). Kneser's conjecture was settled in the affirmative in the sixties for all groups of type other than E_8 ([H1], [H4], [Kn2]). The solution for E_8 came two decades later from Chernousov ([Ch1]). Already in the early sixties, Serre posed the following conjecture, known as Conjecture II ([Se1]):

*The author is partially supported by NSF grant DMS-0653382.

Department of Mathematics and Computer Science, Emory University, 400 Dowman Drive, Atlanta, Georgia 30322, USA. E-mail: parimala@mathcs.emory.edu.

every principal homogeneous space under a semisimple simply connected linear algebraic group over a perfect field of cohomological dimension 2 has a rational point. Serre's conjecture includes Kneser's conjecture for totally imaginary number fields; it also brings into its fold interesting geometric fields like function fields of surfaces over algebraically closed fields. There is a real analogue of Conjecture II, due to Colliot-Thélène ([BP2]) which places the Hasse Principle of Kneser in the general context of virtual cohomological dimension 2.

In this article, we trace the progress towards Conjecture II, beginning with the theorem of Merkurjev-Suslin for groups of inner type A_n . While Conjecture II and the Colliot-Thélène conjecture were settled for groups of classical type ([BP1], [BP2]), they are still open for exceptional groups of type E_6 , E_7 , E_8 and triality D_4 . Conjecture II is proved for these exceptional groups with additional constraints; for quasisplit groups not of type E_8 , the proof is due to Gille ([Gi4]). There are also classes of fields of geometric type, such as function fields of surfaces over algebraically closed fields and two-dimensional strict Henselian fields, where Conjecture II is settled ([CTOP], [CTGP], [dJHS]). The proof of He-de Jong-Starr of Conjecture II for function fields of surfaces uses purely geometric techniques, yielding a classification-free proof of Conjecture II for split simply connected groups over such fields. It is a challenge to construct a classification-free proof of Conjecture II for number fields; such a proof for global fields of positive characteristic is due to Harder ([H3]).

We say that a field k of characteristic zero is of *arithmetic type* if $\text{cd}(k) \leq 2$, k satisfies Conjecture II and k has the property '*index = exponent*' for central simple algebras over all finite extensions of k . Function fields of surfaces over \mathbb{C} (type gl), two-dimensional strict Henselian fields with residue field \mathbb{C} (type ll) and function fields of curves over the field of Laurent series over \mathbb{C} (type lg), besides local fields and totally imaginary number fields are examples of fields of arithmetic type. Over a field of arithmetic type, principal homogeneous spaces under connected linear algebraic groups satisfy several properties typical of number fields. For fields of type (ll), (gl) or (lg), finiteness of R -equivalence classes, finiteness of the defect of the Hasse principle and weak approximation are proved to be true ([CTGP]). An analogue of Harder's theorem on the Hasse principle for rational points on projective homogeneous spaces is also true for fields of type (ll) and (lg).

Rost constructed an invariant for principal homogeneous spaces under simple simply connected linear algebraic groups with values in degree three Galois cohomology ([GMS], p.126). This invariant was useful in handling Conjecture II for groups of type G_2 and F_4 ([Se3], §8, §9) as well as quasisplit groups of type E_6 , E_7 ([Ga1]) and triality D_4 ([Ch2], [Ga2]). Conjecture II may be reformulated as an injectivity statement for the Rost invariant. This leads to questions concerning the injectivity of the Rost invariant for function fields of arithmetic surfaces. This question is particularly interesting for function fields of curves over p -adic fields in the context of Kato's theorems on the unramified degree three Galois cohomology of such fields. Certain patching techniques have

been developed for such fields by Harbater-Hartman-Krashen ([HH], [HHK]). Triviality of the kernel of the Rost invariant for split groups over such a field as well as a local global principle for principal homogeneous spaces under split reductive groups with respect to all discrete valuations of the field have been proved in ([CTPS]) using the patching techniques from ([HH]) and ([HHK]).

1. Galois Cohomology of Classical Groups

Let k be a field, k_s a separable closure of k and $\Gamma_k = Gal(k_s/k)$ the Galois group of k_s over k . For a prime number p , we denote by $cd_p(k)$ the p -cohomological dimension of k defined as the largest integer n such that there exists a finite p -primary Γ_k -module M with $H^n(\Gamma_k, M) \neq 0$. The cohomological dimension $cd(k)$ is the supremum of the $cd_p(k)$ over all prime numbers p .

Let G be a linear algebraic group defined over k . The first non-abelian Galois cohomology set $H^1(k, G) = H^1(\Gamma_k, G(k_s))$ classifies isomorphism classes of principal homogeneous spaces under G , where the neutral element corresponds to the principal homogeneous space with a rational point. Conjecture II states that $H^1(k, G) = 1$ if k is a perfect field of cohomological dimension 2 and G is a semisimple simply connected linear algebraic group defined over k . For a finite extension l of k and a linear algebraic group G defined over l , we have $H^1(k, R_{l/k}(G)) = H^1(l, G)$ where $R_{l/k}(G)$ denotes the Weil restriction of G . In view of this fact, the problem is reduced to looking at absolutely simple simply connected groups while discussing Conjecture II.

The following is the list of absolutely simple simply connected groups of classical type over k :

- 1) (type 1A_n) The special linear group $SL_1(A)$, where A is a central simple algebra over k .
- 2) (type 2A_n) The special unitary group $SU(A, \sigma)$, where A is a central simple algebra over l with a unitary involution σ satisfying $l^\sigma = k$.
- 3) (type C_n) The symplectic group $Sp(A, \sigma)$, A being a central simple algebra over k with a symplectic involution.
- 4) (type B_n, D_n , trialitarian D_4 excluded) The spinor group $Spin(A, \sigma)$, where A is a central simple algebra over k with an orthogonal involution σ , if the characteristic of k is not 2. For characteristic 2, and type B_n and D_n , see ([KMRT], §26.A).

Let $G = SL_1(A)$, where A is a central simple algebra over k . The exact sequence of Γ_k -groups

$$1 \rightarrow SL_1(A) \rightarrow GL_1(A) \rightarrow \mathbf{G}_m \rightarrow 1$$

yields a connecting map in Galois cohomology,

$$k^*/\text{Nrd}(A^*) \rightarrow H^1(k, SL_1(A))$$

which is a bijection, $\text{Nrd} : A \rightarrow k$ denoting the reduced norm map. The following theorem of Merkurjev-Suslin not only settles Conjecture II for groups of type $SL_1(A)$, but gives a converse to it.

Theorem 1.1. (*Merkurjev-Suslin [Su], 24.8*) *Let k be a perfect field. The following are equivalent:*

- 1) $\text{cd}(k) \leq 2$
- 2) *For every finite extension l of k and every central simple algebra A over l , the reduced norm map is surjective.*

The above theorem is a consequence of the injectivity of the map $H^1(k, SL_1(A)) \rightarrow H^3(k, \mu_n^{\otimes 2})$, $[\lambda] \rightarrow (\lambda) \cdot [A]$ (see 3.1), for a central simple algebra of square-free index n ([MS], 12.2).

The proof of Conjecture II for other classical groups is due to Bayer-Parimala ([BP1]) and relies on the Merkurjev-Suslin Theorem (1.1). Let G be a simple simply connected linear algebraic group of type 2), 3) or 4) in the above list. An element in $H^1(k, G)$ gives rise to a hermitian form over the corresponding central simple algebra with involution. We prove the following classification theorem for hermitian forms over division algebras with involution, in terms of invariants, similar to classification results over number fields ([BP1], §4). In the classification theorem below we assume $\text{char}(k) \neq 2$ instead of k perfect.

Theorem 1.2. (*[BP1], §4*) *Let (D, σ) be a central division algebra over a field l with an involution σ and $l^\sigma = k$ and h a hermitian form over (D, σ) . Suppose that $\text{cd}_2(k) \leq 2$.*

- 1) *If σ is of symplectic type, the dimension of h determines the isomorphism class of h .*
- 2) *If σ is of unitary type, the dimension and discriminant determine the isomorphism class of h .*
- 3) *If σ is of orthogonal type, the dimension, discriminant and Clifford invariant determine the isomorphism class of h .*

In the case of orthogonal involutions, the notion of Clifford invariant extends that of quadratic forms ([B]) and takes values in ${}_2\text{Br}(k)/\langle [D] \rangle$ where ${}_2\text{Br}(k)$ denotes the 2-torsion in the Brauer group of k .

If k is a totally imaginary number field, classifying hermitian forms is facilitated by the fact that over such fields there are no anisotropic groups of large

rank of type B_n, C_n and D_n . In contrast, for every n , Merkurjev ([M1]) has constructed fields of cohomological dimension 2 which admit a tensor product $A = H_1 \otimes H_2 \otimes \cdots \otimes H_n$ of n quaternion algebras which is a division algebra. To such a tensor product is associated a $2n + 2$ dimensional anisotropic quadratic form over k ; this produces anisotropic groups of large rank of type D_n .

The proof of the classification theorem goes simultaneously for groups of type ${}^2A_n, B_n, C_n$ and D_n . A key inductive step is provided by an exact sequence in Witt groups of hermitian forms constructed by Parimala-Sridharan-Suresh ([BP1], Appendix 2). The remaining part of the proof of Conjecture II, after classification of hermitian forms, rests in showing that if G is a simply connected group with a central subgroup μ , the image of $H^1(k, \mu) \rightarrow H^1(k, G)$ is zero if $\text{cd}(k) \leq 2$. This is achieved via certain norm principle theorems due to Merkurjev ([M2], [Gi2]).

A classification of central simple algebras with involutions over fields of cohomological dimension 2 is given by Lewis-Tignol ([LT]).

The case of classical groups over perfect fields of cohomological dimension 2 and characteristic 2 is due to Serre ([BP1], Appendix 1).

We refer to ([Se3], §8, §9) for discussions on G_2 and F_4 . Let G be a split simply connected group of type G_2 over a field k . Then $H^1(k, G)$ classifies isomorphism classes of octonion algebras. The isomorphism class of an octonion algebra is determined by its norm form which is a quadratic form of dimension 8. If $\text{char}(k) \neq 2$, the norm form is a 3-fold Pfister form $\langle 1, a \rangle \otimes \langle 1, b \rangle \otimes \langle 1, c \rangle$ for $a, b, c \in k^*$. Let $P_3(k)$ denote the isomorphism classes of 3-fold Pfister forms over k . For $x \in k^*$, (x) denotes the square class of x in $k^*/k^{*2} \simeq H^1(k, \mathbb{Z}/2\mathbb{Z})$. The Arason invariant $e_3 : P_3(k) \rightarrow H^3(k, \mathbb{Z}/2\mathbb{Z})$ given by

$$e_3(\langle 1, a \rangle \otimes \langle 1, b \rangle \otimes \langle 1, c \rangle) = (-a) \cdot (-b) \cdot (-c)$$

is an injection. This leads to the fact that if $\text{cd}_2(k) \leq 2$, then $H^1(k, G) = 1$.

Let G be a split simply connected group of type F_4 over a field k . The set $H^1(k, G)$ classifies isomorphism classes of exceptional central simple 27-dimensional Jordan algebras which we shall refer to as Albert algebras. Suppose $\text{char}(k) \neq 2, 3$. An invariant ‘ g_3 ’ for Albert algebras with values in $H^3(k, \mathbb{Z}/3\mathbb{Z})$ was constructed by Rost ([R]); the vanishing of this invariant ensures that the algebra is ‘reduced’. There is a classification of reduced Jordan algebras by their trace forms due to Springer. The trace form of an Albert algebra J is determined by two invariants, $f_3(J) \in H^3(k, \mathbb{Z}/2\mathbb{Z})$ and $f_5(J) \in H^5(k, \mathbb{Z}/2\mathbb{Z})$. This leads to $H^1(k, G) = 1$ if $\text{cd}_2(k) \leq 2$ and $\text{cd}_3(k) \leq 2$.

2. Real Analogue of Conjecture II

A field k is said to be of *virtual cohomological dimension* n , denoted by $\text{vcd}(k) = n$, if $\text{cd}(k(\sqrt{-1})) = n$. If $\text{char}(k) > 0$, $\text{vcd}(k) = \text{cd}(k)$. The class of fields of virtual cohomological dimension two includes number fields as well as function

fields of surfaces over \mathbb{R} . Let k be a field of characteristic zero. Let V_k denote the space of orderings of k . For $v \in V_k$, let k_v denote the real closure of k in its algebraic closure. The following Hasse principle conjecture, due to Colliot-Thélène, places in a general context Kneser's conjecture for number fields:

Conjecture (HP Conjecture). *Let k be a field of characteristic zero and $\text{vcd}(k) \leq 2$. Let G be a semisimple simply connected linear algebraic group defined over k . Then a principal homogeneous space under G over k has a rational point provided it has a rational point over k_v for every $v \in V_k$.*

In terms of Galois cohomology, the conjecture says that the map

$$H^1(k, G) \rightarrow \prod_{v \in V_k} H^1(k_v, G)$$

has zero kernel.

If k is a number field and A is a central simple algebra over k , the Hasse Principle states that a scalar $\lambda \in k^*$ is a reduced norm from A if it is a reduced norm over k_v for each real closure of k . The local criterion is simply a positivity condition for λ at all orderings where A is ramified. A proof of the HP Conjecture for $SL_1(A)$ over number fields is due to Hasse-Maaß-Schilling. The conjecture is settled for all groups of classical type and of types G_2 and F_4 ([BP2]). For the solution of the conjecture for exceptional groups with constraints, see §5.

3. The Rost Invariant

Let k be a field of characteristic zero and A a central simple algebra over k of index n . We identify the Brauer group of F with $H^2(F, \mathbf{G}_m)$ via the cross product construction as in ([KMRT], p.397); under this correspondence, the n -torsion subgroup of the Brauer group is identified with $H^2(F, \mu_n)$. We write $[A]$ for the class of the central simple algebra A in the $H^2(F, \mu_n)$. The association $\lambda \in k^* \mapsto (\lambda) \cdot [A]$ in $H^3(k, \mu_n^{\otimes 2})$ yields an invariant $H^1(k, SL_1(A)) \simeq k^*/\text{Nrd}(A^*) \rightarrow H^3(k, \mu_n^{\otimes 2})$. We have the following theorem due to Merkurjev-Suslin.

Theorem 3.1. (Merkurjev-Suslin [MS], 12.2) *Let A be a central simple algebra of square-free index. The map $H^1(k, SL_1(A)) \rightarrow H^3(k, \mu_n^{\otimes 2})$ has zero kernel.*

The theorem gives a sufficient condition for a scalar $\lambda \in k^*$ to be a reduced norm from A if its index is square-free. This theorem is critical to the proof of Conjecture II for $SL_1(A)$.

Let q be a regular quadratic form over k with even rank, trivial discriminant and trivial Clifford invariant. Then q is a sum of 3-fold Pfister forms in the Witt group of k . The Arason invariant extends to give an invariant $e_3(q) \in$

$H^3(k, \mathbb{Z}/2\mathbb{Z})$ ([A], Thm. 5.7). Let $G = Spin(q)$. An element $\zeta \in H^1(k, G)$ yields the isomorphism class of a quadratic form q' over k under the composite map $H^1(k, Spin(q)) \rightarrow H^1(k, SO(q)) \rightarrow H^1(k, O(q))$. The quadratic form $q' \perp -q$ has even dimension, trivial discriminant and trivial Clifford invariant. The map $H^1(k, Spin(q)) \rightarrow H^3(k, \mathbb{Z}/2\mathbb{Z})$, $\zeta \mapsto e_3(q' \perp -q)$ is an invariant, called the *Arason invariant* for $Spin(q)$.

Rost proved the existence of an invariant $R_G : H^1(k, G) \rightarrow H^3(k, \mathbb{Q}/\mathbb{Z}(2))$ for any absolutely simple simply connected linear algebraic group G defined over a field k of characteristic zero. We refer to an exposition of Merkurjev in ([GMS], p.126) for the definition of the Rost invariant which builds on a theorem of Bruno Kahn ([K], see also [EKL]). In view of the norm residue isomorphism theorem of Merkurjev-Suslin ([MS]), $H^3(k, \mathbb{Z}/n\mathbb{Z}(2)) \rightarrow H^3(k, \mathbb{Q}/\mathbb{Z}(2))$ is injective and R_G takes values in $H^3(k, \mathbb{Z}/n\mathbb{Z}(2))$ where the only primes dividing n are the ‘homological torsion primes’ associated to G (cf. §4). The invariant R_G is a ‘canonical’ generator of cohomological invariants in degree 3 with values in $\mathbb{Q}/\mathbb{Z}(2)$ ([KMRT], §31). The Arason invariant for $Spin(q)$ and the f_3 invariant for F_4 (cf. §1) coincide with the 2-primary part of the Rost invariant. For groups of type G_2 , the Rost invariant coincides with the Arason invariant of the norm form. The invariant for $SL_1(A)$ defined above is the negative of the Rost invariant (in characteristic zero), in view of the recent work of Gille-Quéguiner ([GQ]); in fact their work also leads to identifying the g_3 invariant for groups of type F_4 defined by Rost ([R]) with the 3-primary part of the Rost invariant.

The Rost invariant is a powerful tool in the study of principal homogeneous spaces under simply connected groups. The map R_G can be defined in arbitrary characteristic ([GMS], §2, Appendix A). If $\text{char}(k) = p$, the p -primary part of R_G should be interpreted as having values in the Kato cohomology groups $H^3(k, \mathbb{Q}_p/\mathbb{Z}_p(2))$. The group $H^n(k, \mathbb{Z}/p\mathbb{Z}(2))$, denoted by $H_p^n(k)$ has the following description. Let Ω_k^1 denote the module of absolute differentials of k and $\Omega_k^n = \wedge^n \Omega_k^1$. Then $H_p^{n+1}(k)$ is the cokernel of the homomorphism

$$\Omega_k^n \rightarrow \Omega_k^n / d\Omega_k^{n-1}$$

induced by $x \cdot \left(\frac{dy_1}{y_1}\right) \wedge \left(\frac{dy_2}{y_2}\right) \cdots \wedge \left(\frac{dy_n}{y_n}\right) \mapsto (x^p - x) \cdot \left(\frac{dy_1}{y_1}\right) \wedge \left(\frac{dy_2}{y_2}\right) \cdots \wedge \left(\frac{dy_n}{y_n}\right)$.

4. Strengthening of Conjecture II

Given an absolutely simple simply connected linear algebraic group defined over a field k , Serre ([Se3], 2.2) defines the set $S(G)$ of primes associated to G ‘which plays a special role in the structure of $H^1(k, G)$ ’. After a suggestion from Serre, we call these primes *homological torsion primes*. Serre poses a strengthening of Conjecture II which includes the case of not necessarily perfect fields ([Se3] §10). For a field k of characteristic p , we have the cohomology groups $H_p^n(k)$

defined by Kato (see §3). The *separable p -dimension* $\text{sd}_p(k)$ of a field k is defined as follows:

- a) if $\text{char}(k) \neq p$, $\text{sd}_p(k) = \text{cd}_p(k)$
- b) if $\text{char}(k) = p$, $\text{sd}_p(k)$ is the least integer r such that $H_p^{r+1}(l) = 0$ for every finite separable extension l of k .

Conjecture (Strong Conjecture II). *Let G be an absolutely simple simply connected linear algebraic group over a field k . Suppose that for every $p \in S(G)$, $\text{sd}_p(k) \leq 2$. Then $H^1(k, G) = 1$.*

Gille observes ([Gi5], §2) that the additional condition $[k : k^p] \leq p^2$ if $\text{char}(k) = p$ proposed by Serre in the strengthening of Conjecture II is not used in the cases where Strong Conjecture II is proved. Strong Conjecture II for groups of type 1A_n is due to Gille ([Gi3], Thm. 7). Gille in fact proves that $\text{sd}_p(k) \leq 2$ if and only if for every finite extension l of k , the reduced norm map on every p -primary central simple algebra is surjective. His method of proof involves lifting of the Rost invariant in characteristic p to characteristic zero and then appealing to the theorem of Merkurjev-Suslin. Berhuy-Frings-Tignol ([BFT]) prove Strong Conjecture II for all classical groups, using Gille's theorem on reduced norms. Strong Conjecture II holds also for groups of type G_2 and F_4 ([Se3], Thm. 11, [Gi3], Thm. 8, Thm. 9), which is a consequence of the properties of the Rost invariant map in arbitrary characteristic.

5. Exceptional Groups

Conjecture II for quasisplit groups not containing a factor of type E_8 is settled by Gille ([Gi4]) through a study of norm groups of varieties of Borel subgroups. The techniques in that paper lead to several interesting consequences, including a new proof of the Hasse principle for quasisplit groups over number fields. Let G be an absolutely simple simply connected linear algebraic group defined over k . Suppose that $\text{sd}_p(k) \leq 2$ for every prime $p \in S(G)$. Let μ be the center of G and

$$1 \rightarrow \mu \rightarrow G \rightarrow G^{ad} \rightarrow 1$$

the central isogeny, G^{ad} denoting the adjoint group of G . The set $H^1(k, G)$ is zero if and only if the following two conditions hold:

- a) The connecting map $\delta : G^{ad}(k) \rightarrow H^1(k, \mu)$ is surjective.
- b) The image of $H^1(k, G) \rightarrow H^1(k, G^{ad})$ is zero.

Gille proves that the condition $\text{sd}_p(k) \leq 2$ for every $p \in S(G)$ implies condition a); the part of $H^1(k, G)$ arising from the center is zero. Thus Conjecture II is equivalent to statement b). Further, Gille proves Conjecture II for simply

connected groups of type ${}^{3,6}D_4$, E_6 and E_7 under certain assumptions on the indices of the corresponding Tits algebras:

Theorem 5.1. (Gille [Gi4]) *Let G be an absolutely simple simply connected group defined over a field k with $\text{sd}_p(k) \leq 2$ for every $p \in S(G)$.*

- a) *Suppose G is of type ${}^{3,6}D_4$, $\text{char}(k) \neq 2$ and the Tits algebra of G has index at most 2. Then $H^1(k, G) = 1$.*
- b) *Suppose G is of type E_6 and the Tits algebra of G has index at most 3. Then $H^1(k, G) = 1$.*
- c) *Suppose G is of type E_7 and the Tits algebra of G has index at most 4. Then $H^1(k, G) = 1$.*
- d) *Suppose G is the split group of type E_8 and $\text{char}(k) = 0$. Then for every cyclic extension L/k of degree 2, 3, or 5, $H^1(L/k, E_8) = 1$.*

Conjecture I of Serre ([Se1]) asserts that if $\text{cd}(k) \leq 1$, $H^1(k, G) = 1$ for any connected linear algebraic group over k . Conjecture I was proved by Steinberg ([St]). A real analogue of Steinberg’s theorem is due to Scheiderer ([Sch]).

Let k be a field of cohomological dimension two with $\text{char}(k) = 0$ and $\text{cd}(k^{ab}) \leq 1$, k^{ab} denoting the maximal abelian extension of k . Let G be the split group of type E_8 and $\xi \in H^1(k, G)$. Then by Steinberg’s theorem there exists a maximal k -torus T of G and $\xi_1 \in H^1(k, T)$ which maps to ξ under $H^1(k, T) \rightarrow H^1(k, G)$ ([PR], 6.19). The order of ξ_1 is $2^\alpha 3^\beta 5^\gamma$ for some non-negative integers α, β, γ ([PR], 6.21). Since $\text{cd}(k^{ab}) \leq 1$, by Steinberg’s theorem, ξ_1 is zero over k^{ab} . Let L/k be a finite abelian extension such that ξ_1 is zero over L . Let E/k be a subextension of L/k such that $[L : E]$ is coprime to 2, 3 and 5, and the only prime divisors of $[E : k]$ are 2, 3 or 5. Then ξ_1 is zero over E since the order of ξ_1 is prime to $[L : E]$. Since E/k can be filtered by a tower of cyclic extensions of order 2, 3 or 5, it follows that ξ is split by such a tower. Thus the following is a consequence of (5.1(d)). The proof of (5.1(d)) in ([Gi4]) is parallel to that of Chernousov for number fields.

Theorem 5.2. (Gille [Gi4], §IV.2) *Let k be a field of characteristic zero, $\text{cd}_2(k) \leq 2$, $\text{cd}_3(k) \leq 2$ and $\text{cd}_5(k) \leq 2$. Suppose $\text{cd}(k^{ab}) \leq 1$. If G is a simple simply connected group of type E_8 , then $H^1(k, G) = 1$.*

Another approach to the proof of Conjecture II for quasisplit groups of type ${}^{3,4}D_4$, E_6 and E_7 is through the study of the kernel of the Rost invariant map, due to Garibaldi ([Ga1]) for E_6 and E_7 and Chernousov for D_4 ([Ch2], [Ga2]). They show that for an arbitrary field k of characteristic zero and G a quasisplit group of type ${}^{3,6}D_4$, E_6 , E_7 , the Rost invariant map $R_G : H^1(k, G) \rightarrow H^3(k, \mathbb{Q}/\mathbb{Z}(2))$ has zero kernel. Using an effective lifting of the Rost invariant from characteristic p to characteristic zero, due to Gille ([Gi1]), one deduces the injectivity of the $R_G : H^1(k, G) \rightarrow H^3(k, \mathbb{Q}/\mathbb{Z}(2))$ for groups of

type ${}^{3,6}D_4, E_6, E_7$ in arbitrary characteristic, interpreting the p -primary torsion in $H^3(k, \mathbb{Q}/\mathbb{Z}(2))$ as Kato groups. In particular, $H^1(k, G) = 1$ for G quasisplit of type ${}^{3,6}D_4, E_6$ and E_7 if $\text{sd}_p(k) \leq 2$ for all $p \in S(G)$. If $\text{char}(k) = 0$ and $\text{vcd}(k) \leq 2$, $H^3(k, \mathbb{Q}_p/\mathbb{Z}_p(2)) = 0$ if $p \neq 2$ and $H^3(k, \mathbb{Q}_2/\mathbb{Z}_2(2)) \rightarrow \prod_{v \in V_k} H^3(k_v, \mathbb{Q}_2/\mathbb{Z}_2(2))$ has zero kernel ([AEJ1], §2). These results lead to the Hasse Principle conjecture for these groups over fields of virtual cohomological dimension two.

6. Arithmetic of Certain Two-dimensional Fields

The following are some well known properties of number fields k :

- (Hasse-Brauer-Noether, Albert) Index and exponent coincide for central simple algebras over k .
- (Hasse-Brauer-Noether, Albert) Every central division algebra over k is cyclic.
- (Hasse-Brauer-Noether) Let Ω_k denote the set of all places of k and for $v \in \Omega_k$, k_v the completion of k at v . Then the map

$$Br(k) \rightarrow \bigoplus_{v \in \Omega_k} Br(k_v)$$

has zero kernel.

- (Hasse-Minkowski) A quadratic form q over k is isotropic if it is isotropic over all k_v , $v \in \Omega_k$. In particular, if k is a totally imaginary number field, every quadratic form in at least 5 variables over k is isotropic.
- If k^{ab} denotes the maximal abelian extension of k , $\text{cd}(k^{ab}) = 1$ ([Se2]).

We discuss analogues of these properties in the context of the following two-dimensional fields of geometric type.

- (ll) Two-dimensional strict Henselian field, i.e. field of fractions of a Henselian excellent two-dimensional local domain A with separably closed residue field k .
- (gl) Function field of a surface over an algebraically closed field.
- (lg) $F = k((t))(X)$, k an algebraically closed field and X an integral curve over $k((t))$.

Fields of type (ll) were studied in [CTOP] where it is shown that they satisfy ‘essentially’ all the properties listed above for number fields. Let A be a two-dimensional excellent Henselian local domain with field of fractions F and

separably closed residue field k . Examples of such fields are finite extensions of $k((X, Y))$ where k is separably closed. If ℓ is a prime not equal to $\text{char}(k)$, then $\text{cd}_\ell(F) = 2$ (SGA 4, Cor 6.3, XIX). Let Ω_F denote the set of all rank one discrete valuations of F and let F_v denote the completion of F at v for $v \in \Omega_F$. The following theorems ([CTOP]) describe the arithmetic properties of fields of type (II).

Theorem 6.1. ([CTOP], Thm. 2.1) *Let F be a field of type (II) and D a central division algebra over F of exponent n . Suppose n is coprime to $\text{char}(k)$. Then D is cyclic of index n .*

The above theorem for $\text{char}(k) = 0$ is due to Ford-Saltman ([FS]).

Theorem 6.2. ([CTOP], Thm. 2.3) *Let F be a field of type (II) with $\text{char}(k) = 0$. Then $\text{cd}(F^{ab}) \leq 1$, where F^{ab} denotes the maximal abelian extension of F .*

Theorem 6.3. ([CTOP], Cor. 1.10) *Let F be a field of type (II). Then the restriction map*

$$\text{Br}(F) \rightarrow \prod_{v \in \Omega_F} \text{Br}(F_v)$$

has zero kernel.

In fact, in Theorem 6.3, one may restrict $v \in \Omega_F$ to the set of rank one discrete valuations of F centered on codimension one points of a regular proper scheme $\mathcal{X} \rightarrow \text{Spec}(A)$ with function field F .

Theorem 6.4. ([CTOP], Thm. 3.6 and Thm. 3.1) *Let F be a field of type (II). Suppose the characteristic of k is different from 2. Then every quadratic form over F of dimension at least 5 is isotropic. Further, every quadratic form of dimension 3 or 4 over F is isotropic if it is isotropic over F_v for every $v \in \Omega_F$.*

An example of the failure of the Hasse principle for quadratic forms in dimension 2 is due to Jaworski ([Ja]). In other words, the local square theorem fails in this setting.

One has real analogues of these results for two-dimensional Henselian fields with real closed residue field. For such a field F , every torsion quadratic form of dimension greater than four has a nontrivial zero; in other words, the u -invariant $u(F)$, in the sense of Elman-Lam, is at most 4. In particular, $u(\mathbb{R}((X, Y))) = 4$; It is an open question whether the u -invariant of $\mathbb{R}(X, Y)$ is 4.

Let $F = k(X)$ be the function field of a surface over an algebraically closed field k . The field F has the C_2 property. The following question is due to M. Artin ([Ar]).

Question. (Artin) *Let K be a C_2 field. Do the index and exponent of central simple algebras over K coincide?*

Artin points out that for central simple algebras of index a power of 2 or 3, an affirmative answer to the question follows from elementary arguments. Artin's question is answered in the affirmative for function fields of surfaces over algebraically closed fields by de Jong ([dJ], [Li]). Cyclicity of prime degree algebras over such fields is already a challenge (cf. [V], [KRTY]). The question of whether $\text{cd}(F^{ab}) \leq 1$ is part of a general conjecture of Bogomolov and is wide open. There are no analogues of the Hasse principle for Brauer groups or quadratic forms for (gl) fields in view of the fact that the Brauer group of a surface over an algebraically closed field is in general nonzero. Since (gl) fields satisfy the C_2 property, every 5-dimensional quadratic form over such fields is isotropic.

Let $F = k((t))(X)$ be of type (lg). Let $\overline{k((t))}$ denote the algebraic closure of $k((t))$. Then $F' = \overline{k((t))}(X)$ is a Galois (pro) cyclic extension of F with $\text{cd}(F') \leq 1$. In particular, $\text{cd}(F^{ab}) \leq 1$. Since F is a C_2 field, $\text{index} = \text{exponent}$ for central simple algebras over F with index a power of 2 or 3. In fact, following Saltman's proof of splitting ramification of central simple algebras over function fields of two-dimensional regular schemes ([S]), one can show that index and exponent coincide for all central simple algebras over F (see also [HHK], Thm.5.5). Let $\mathcal{X} \rightarrow \text{Spec}(k[[t]])$ be a regular proper model of the curve X over $k((t))$. Then $\text{Br}(\mathcal{X}) = 0$ ([CTOP], 1.10) and the map $\text{Br}(F) \rightarrow \prod_{v \in \Omega_F} \text{Br}(F_v)$ has trivial kernel.

In the next section, we discuss how these arithmetic properties of fields of type (ll), (gl) and (lg) lead to consequences for linear algebraic groups and homogeneous spaces defined over such fields.

7. Arithmetic of Linear Algebraic Groups over Two-dimensional Fields

Let A be a two-dimensional strict Henselian local domain with field of fractions F and residue field k of characteristic zero. Then F satisfies the conditions $\text{index} = \text{exponent}$ for central simple algebras and $\text{cd}(F^{ab}) \leq 1$. In view of (5.1), (5.2), Conjecture II holds for F .

Let $F = k(X)$, X a smooth integral surface over an algebraically closed field k . The property $\text{index} = \text{exponent}$ for central simple algebras over F leads to Conjecture II for all groups not containing a factor of type E_8 . There is a uniform proof of Conjecture II for split simply connected groups over F in arbitrary characteristic due to de Jong-He-Starr ([dJHS]). Thus Conjecture II is proved for fields of type (gl). The proof ([dJHS], 1.5) involves deformation techniques in complex algebraic geometry. The following key ingredient in their proof is a consequence of a more general theorem.

Theorem 7.1. ([dJHS], Thm. 1.4) *Let F be a field of type (gl) and G_0 a split simply connected group over F . Let $\zeta \in H^1(F, G_0)$ and G the group obtained*

from G_0 by twisting through a cocycle defining ζ . Let P be an F -parabolic subgroup of G_0 and V the variety of F -parabolic subgroups of G of type P . Then $V(F) \neq \emptyset$.

We refer to ([Gi5], 6.5) for a proof of how this theorem leads to Conjecture II for split simply connected groups over F .

Suppose $F = k((t))(X)$, where k is an algebraically closed field and X is an integral curve over $k((t))$. In view of the fact that *index = exponent* for central simple algebras over F and $\text{cd}(F^{ab}) \leq 1$, Conjecture II holds for F .

Definition. We call a field F of characteristic zero of *arithmetic type* if it satisfies the following conditions:

- 1) $\text{cd}(F) \leq 2$
- 2) For every finite extension E/F , index and exponent of central simple algebras over E coincide
- 3) $H^1(F, G) = 1$ for a semisimple simply connected linear algebraic group G over F .

We remark that the condition 3) above would be redundant once Conjecture II is proved for groups of type E_8 for fields satisfying 1) and 2).

Examples of fields of arithmetic type are totally imaginary number fields and fields of type (ll), (gl) and (lg). Several properties of linear algebraic groups and principal homogeneous spaces, which are classical for totally imaginary number fields, can be proved to be true for fields of arithmetic type. We refer to ([CTGP]) for a discussion of the following results.

Let G be a semisimple simply connected linear algebraic group defined over a field F . Let

$$1 \rightarrow \mu \rightarrow G \rightarrow G^{ad} \rightarrow 1$$

be the central isogeny, where G^{ad} denotes the adjoint group of G . Let $\delta : H^1(F, G^{ad}) \rightarrow H^2(F, \mu)$ be the connecting map in Galois cohomology.

Theorem 7.2. ([CTGP], Thm. 2.1) *Let F be a field of arithmetic type. Then $\delta : H^1(F, G^{ad}) \rightarrow H^2(F, \mu)$ is a bijection.*

This theorem for number fields is classical (cf. [Kn2]), the unitary case being a theorem of Landherr ([Sc], p.383).

Theorem 7.3. ([CTGP], Thm. 4.3) *Let F be a field of arithmetic type and G a semisimple simply connected linear algebraic group defined over F not containing a factor of type A_n . Then the F -variety G is F -rational, i.e. birational to an affine space over F .*

Rationality is a consequence of isotropicity of G if it has no factor of type A_n . This leads to the triviality of R -equivalence classes $G(F)/R$ if G is simply

connected and has no factor of type A_n . If $G = SL_1(A)$ then $G(F)/R = SK_1(A)$ ([Vo]); in view of a theorem of Yanchevskiĭ ([Y]), this group is zero for all fields of cohomological dimension two. Triviality of $G(F)/R$ for simply connected groups of type 2A_n over fields of cohomological dimension at most 2 is due to Chernousov and Merkurjev ([CM]). We thus have the following:

Theorem 7.4. ([CTGP], Thm. 4.5) *Let F be a field of arithmetic type and G a semisimple simply connected group defined over F . Then the group of R -equivalence classes $G(F)/R$ is zero.*

We discuss finiteness of R -equivalence classes, obstruction to Hasse principle and weak approximation for connected linear algebraic groups over fields of arithmetic type.

Let G be a connected reductive group defined over any field F . Then G admits a flasque resolution, namely, there are (nearly canonical) exact sequences ([CT], Prop.3.1)

$$1 \rightarrow \mathcal{F} \rightarrow H \rightarrow G \rightarrow 1$$

where \mathcal{F} is a flasque torus and H is an extension of quasitrivial torus by a semisimple simply connected group. This induces an exact sequence of groups ([CT], Thm. 8.1)

$$H(F)/R \rightarrow G(F)/R \rightarrow \text{Ker}(H^1(F, \mathcal{F}) \rightarrow H^1(F, H)) \rightarrow 1.$$

If F is a field of arithmetic type, then $H^1(F, H) = 1$ and using a delicate argument of Gille ([Gi4], [BKG] Appendix) one has $H(F)/R = 1$. In particular, $G(F)/R \simeq H^1(F, \mathcal{F})$ ([CT], Thm. 8.4).

This leads to the fact that $G(F)/R$ is abelian. It is an open question whether the group of R -equivalence classes is abelian for a general field.

Theorem 7.5. (cf. [CTGP], Thm. 4.12) *Let F be a field of arithmetic type. Suppose $H^1(F, \mathcal{F})$ is finite for every flasque torus \mathcal{F} over F . Then $G(F)/R$ is finite for a connected linear algebraic group G defined over F .*

The finiteness of $H^1(F, \mathcal{F})$ for flasque tori \mathcal{F} is proved in ([CTGP], Thm. 3.4) for fields of type (gl) and (ll). In the case (lg), we have $F = k((t))(X)$ where X is an integral curve over $k((t))$. The field $k((t))$ has finite cohomology in the sense of ([CTGP], p.312) and the finiteness of $H^1(F, \mathcal{F})$ for flasque tori \mathcal{F} follows from ([CTGP], 3.4).

Corollary 7.6. ([CTGP], Thm. 4.12) *Let F be a field of type (gl), (ll) or (lg). Then $G(F)/R$ is finite for a connected linear algebraic group G defined over F .*

The above result for number fields is due to Colliot-Thélène and Sansuc ([CTS]) for quasisplit groups and Gille ([Gi2]) in the general case.

There are also theorems concerning finiteness of the obstruction to the Hasse principle and weak approximation for connected linear algebraic groups over fields of type (ll) and (gl) ([CTGP], Thm. 5.1, Thm. 4.13); the original results over number fields are due to Sansuc ([Sa]). We shall now explain these results in the context of fields of arithmetic type.

Let F be a field and Ω a set of rank one discrete valuations of F . For a linear algebraic group G defined over F , let $\text{III}_\Omega^i(F, G)$ denote the kernel of the map $H^i(F, G) \rightarrow \prod_{v \in \Omega} H^i(F_v, G)$, with the convention $i \leq 1$ if G is not abelian.

Let A be a Noetherian excellent strict Henselian local domain of dimension at most 2 with field of fractions K . Let F be a finitely generated field over K . Let $\mathcal{X} \rightarrow \text{Spec}(A)$ be a proper morphism with \mathcal{X} regular and with function field F . Let $\Omega_{\mathcal{X}}$ denote the set of all rank one discrete valuations of F centered on codimension 1 points of \mathcal{X} . Let Ω denote the union of $\Omega_{\mathcal{X}}$ as \mathcal{X} varies over regular proper schemes over $\text{Spec}(A)$ with function field F . We call Ω the set of *divisorial* discrete valuations of F . The fields of type (ll), (gl) and (lg) are all function fields of two-dimensional regular schemes which are proper over strict Henselian local domains. In these cases Ω stands for the set of divisorial discrete valuations of the corresponding fields.

We have the following:

Theorem 7.7. (cf. proof of [CTGP], Thm. 5.1) *Let F be a field of arithmetic type and Ω a set of rank one discrete valuations. Let G be a connected linear algebraic group defined over F . Suppose that $\text{III}_\Omega^2(F, \mu)$ is finite for every finite F -group μ of multiplicative type. Then $\text{III}_\Omega^1(F, G)$ is finite.*

Corollary 7.8. (cf. [CTGP], Thm. 5.1) *Let F be of type (ll), (lg) or (gl) and Ω the set of divisorial discrete valuations of F . Let G be a connected linear algebraic group defined over F . Then $\text{III}_\Omega^1(F, G)$ is finite.*

Proof. We will just outline the case when F is of type (lg) which is similar to the case (ll). Suppose $F = k((t))(X)$ where k is an algebraically closed field and X an integral curve over $k((t))$. Let $\mathcal{X} \rightarrow \text{Spec}(k[[t]])$ be a regular proper model of X . There exists an open subset U of \mathcal{X} and an étale sheaf μ_U on U such that μ_U restricts to μ on F . The map $H^2(U, \mu_U) \rightarrow H^2(F, \mu)$ contains in its image $\text{III}_\Omega^2(F, \mu)$. In view of ([SGA 4], Exp. XIX, Thm 5.1), $H^2(U, \mu_U)$ is finite and hence $\text{III}_\Omega^2(F, \mu)$ is finite. \square

Theorem 7.9. (cf. proof of [CTGP], Thm. 4.13) *Let F be a field of arithmetic type and S a finite set of rank one discrete valuations of F . Suppose $H^1(F_v, \mathcal{F})$ is finite for every $v \in S$ and for every flasque torus \mathcal{F} over F_v . Let G be a connected linear algebraic group defined over F . Let $\overline{G(F)}$ denote the closure of $G(F)$ under the diagonal embedding $G(F) \rightarrow \prod_{v \in S} G(F_v)$. Then the defect of weak approximation*

$$A_S(G) = \prod_{v \in S} G(F_v) / \overline{G(F)}$$

is finite.

Corollary 7.10. (cf. [CTGP], 4.13) Let F be a field of type (ll), (gl) or (lg) and S a finite set of divisorial discrete valuations of F . Let G be a connected linear algebraic group defined over F . Let $\overline{G(F)}$ denote the closure of $G(F)$ under the diagonal embedding $G(F) \rightarrow \prod_{v \in S} G(F_v)$. Then the defect of weak approximation

$$A_S(G) = \prod_{v \in S} G(F_v)/\overline{G(F)}$$

is finite.

Proof. We discuss the case $F = k((t))(X)$ of type (lg). The completion of F at any $v \in S$ is of the form $k((t'))((s))$ or $k(X')((s))$, where X' is a curve over k . In either case in view of ([CTGP], Thm. 3.2 and Thm. 3.4), $H^1(F_v, \mathcal{F})$ is finite for any flasque torus over F_v . \square

In ([BKG]), using the above results, Borovoi, Kunyavskii and Gille compute $G(F)/R$, $\text{III}_\Omega^1(F, G)$ and $A_S(G)$ in terms of the algebraic fundamental group of G . They show that for fields of type (gl) or (ll), $G(F)/R$, $A_S(G)$ and $\text{III}_\Omega^1(F, G)$ are stably F -birational invariants of G . A key step in their proof is to show that for a connected linear algebraic group G defined over any field, the Galois module $\text{Pic } \overline{V}_G$ is flasque, where $\overline{V}_G = V_G \times \overline{k}$ and V_G denotes a smooth compactification of G . This generalizes a theorem of Voskresenskii on tori; this result is extended to homogeneous spaces with connected stabilisers in a paper of Colliot-Thélène and Kunyavskii in ([CTK]).

We shall now discuss the Hasse principle for projective homogeneous spaces under connected linear algebraic groups defined over fields of arithmetic type (cf. [CTGP], §5). An analogous theorem for number fields is due to Harder ([H2]). There is a proof due to Borovoi ([Bo]) of Harder's theorem which lends itself to a more general setting. Let F be a field of arithmetic type and H a semisimple simply connected linear algebraic group defined over F . Let X be a projective homogeneous space under H . Let \overline{G} be the stabiliser of a point in $X(\overline{F})$. Since X is projective, \overline{G} is a parabolic subgroup of $H(\overline{F})$. Let G^{tor} be the biggest quotient torus of \overline{G} . Then G^{tor} is defined over F and is quasitrivial ([CTGP], 5.6). Following Borovoi, one associates to the homogeneous space X an element $i_*(X) \in H^2(F, G^{tor})$ with the property that $i_*(X) = 0$ if and only if X lifts to a principal homogeneous space under H . For fields of arithmetic type F , we have $H^1(F, H) = 0$ and $i_*(X) = 0$ if and only if $X(F) \neq \emptyset$. Let Ω be a set of discrete valuations of F . If $X(F_v) \neq \emptyset$ for every $v \in \Omega$, then $i_*(X) \in \text{III}_\Omega^2(F, G^{tor})$. Suppose G^{tor} is isomorphic to product of $R_{L_i/F}(\mathbf{G}_m)$, where L_i/F are finite extensions. Then $\text{III}_\Omega^2(F, G^{tor})$ is isomorphic to the product of $\text{III}_\Omega^2(L_i, \mathbf{G}_m)$. We thus have:

Theorem 7.11. ([CTGP], Thm. 5.5) Let F be field of type (ll) or (lg). Let X be a projective homogeneous space under a connected linear algebraic group G over F . Then the Hasse principle holds for the existence of rational points on X with respect to all divisorial discrete valuations of F .

Proof. If F is of type (ll), for every finite extension L/F , $\text{III}_\Omega^2(L, \mathbf{G}_m) = 0$ (6.3). If $F = k((t))(X)$ be of type (lg), then $\text{III}_\Omega^2(F, \mathbf{G}_m) = 0$ (cf. §6). Since every finite extension of F is again of the type (lg), the theorem follows. \square

8. Function Fields of Arithmetic Surfaces

Let F be a field of characteristic zero. Let G be an absolutely simple simply connected linear algebraic group defined over F . Let $R_G : H^1(F, G) \rightarrow H^3(F, \mathbb{Q}/\mathbb{Z}(2))$ be the Rost invariant (cf. §3). Conjecture II may be reformulated as an injectivity statement for R_G for fields of cohomological dimension two. A general setting to look for the injectivity of R_G is the case of fields of cohomological dimension at most three. In fact the following result for quasisplit groups can be obtained from known results for R_G .

Theorem 8.1. ([CTPS], Thm. 5.4) *Let F be a field of characteristic zero and $\text{cd}(F) \leq 3$. Let G/F be an absolutely simple simply connected quasisplit group not containing an E_8 factor. Then $R_G : H^1(F, G) \rightarrow H^3(F, \mathbb{Q}/\mathbb{Z}(2))$ has zero kernel.*

The proof for classical groups reduces to classification of quadratic and hermitian forms over fields of cohomological dimension 3; the Milnor conjecture in this case is due to Arason-Elman-Jacob ([AEJ2]). The cases of E_6 and E_7 are due to Garibaldi ([Ga1]) and for the case of triality D_4 we refer to ([Ch2], [Ga2]). The cases of G_2 and F_4 are discussed in ([Se3]). However, for a general field of cohomological dimension 3 and G not quasisplit, there are examples due to Merkurjev ([CTPS], 5.2) for which R_G has nonzero kernel. There exist fields F with $\text{cd}(F) = 3$, a quaternion division algebra A over F and an element $\lambda \in F$ which is not a reduced norm from A such that $(\lambda) \cdot [A] = 0$ in $H^3(F, \mu_2^{\otimes 2})$. Thus, $[\lambda] \in F^*/\text{Nrd}(A^*) = H^1(F, SL_1(A))$ is nontrivial and $R_G([\lambda]) = 0$. This construction involves fields which are not of arithmetic type. A natural question is whether the kernel of R_G is zero if F is a field of cohomological dimension 3 which is finitely generated over a number field, a local field, a real closed field or an algebraically closed field.

Function fields of p -adic curves are studied in ([CTPS]). The following theorem asserts that the Rost invariant map has zero kernel for split groups of type E_8 as well.

Theorem 8.2. ([CTPS], Thm. 5.5) *Let \mathcal{O} be the ring of integers in a p -adic field k and κ its residue field. Let X/k be a smooth projective geometrically integral curve and $F = k(X)$. Let G be an absolutely simple simply connected group over \mathcal{O} . If G is of type E_8 , we assume that the prime p is different from 2, 3 and 5. Then the kernel of the Rost map $R_G : H^1(F, G) \rightarrow H^3(F, \mathbb{Q}/\mathbb{Z}(2))$ is zero.*

We note that the group G_F is quasisplit since the special fiber G_κ is quasisplit, κ being a finite field ([St]). The proof of (8.2) uses a Hasse principle for

principal homogeneous spaces under G_F where G/\mathcal{O} is a connected reductive group:

Theorem 8.3. (*[CTPS], Thm. 4.8*) *Let \mathcal{O} be the ring of integers in a p -adic field k with residue field κ . Let X/k be a smooth projective geometrically integral curve. Let $F = k(X)$ and Ω_F the set of all discrete valuations of k . Let G be a connected reductive group over \mathcal{O} . Then the restriction map $H^1(F, G) \rightarrow \prod_{v \in \Omega_F} H^1(F_v, G)$ has zero kernel.*

Let $\mathcal{X} \rightarrow \text{Spec}(\mathcal{O})$ be a regular proper model of $X \rightarrow \text{Spec}(k)$. An element $\zeta \in H^1(F, G)$, which is trivial in $H^1(F_v, G)$ for every $v \in \Omega_F$, is unramified at all codimension one points of \mathcal{X} . Theorem 8.3 is a consequence of the following:

Theorem 8.4. (*[CTPS], Thm. 4.6*) *With the same notation as in Theorem 8.3, an element $\zeta \in H^1(F, G)$ unramified at all codimension one points of \mathcal{X} is trivial.*

The above theorem applied to PGL_n recovers a theorem of Grothendieck that the Brauer group of a regular proper model \mathcal{X}/\mathcal{O} of a curve over a p -adic field is zero.

We conclude by showing how the Hasse principle leads to the injectivity of the Rost invariant. We have a commutative diagram

$$\begin{CD} H^1(F, G) @>\rho>> \prod_{v \in \Omega} H^1(F_v, G) \\ @V R_G VV @VV \prod R_G V \\ H^3(F, \mathbb{Q}/\mathbb{Z}(2)) @>(\rho_v)>> \prod_{v \in \Omega} H^3(F_v, \mathbb{Q}/\mathbb{Z}(2)) \end{CD}$$

By Theorem 8.3, ρ has zero kernel. To show that R_G has zero kernel, it suffices to show that for every $v \in \Omega_F$,

$$R_G : H^1(F_v, G) \rightarrow H^3(F_v, \mathbb{Q}/\mathbb{Z}(2))$$

has zero kernel. The proof of this fact uses Bruhat-Tits theory.

The proof of Theorem 8.4 uses a certain patching technique for function fields of curves over complete discrete valued fields developed by Harbater-Hartmann-Krashen ([HH], [HHK]). Suppose $F = k(X)$ is the function field of a smooth projective curve over a complete discrete valued field k . Let \mathcal{O} be the ring of integers in k and let κ be the residue field. Let $\mathcal{X} \rightarrow \text{Spec}(\mathcal{O})$ be a regular proper model of X and X_0 the reduced special fiber of \mathcal{X} . We assume, by possibly blowing up \mathcal{X} , that X_0 consists of regular curves with normal crossings. Let $\{U_i\}$, $1 \leq i \leq n$ be nonempty open subsets of the components Y_i of X_0 and $\mathcal{P} = \{P_i \mid 1 \leq i \leq m\}$ be a finite set of closed points of X_0 containing all singular points of X_0 . Suppose $X_0 = \cup_{1 \leq i \leq n} U_i \cup \mathcal{P}$. Let R_{U_i} be the ring of rational functions on \mathcal{X} which are regular on U_i , and F_{U_i} the field of fractions of the completion of R_{U_i} along the ideal tR_{U_i} , where t denotes a parameter in \mathcal{O} . For any closed point P of X_0 , let F_P denote the field of fractions of the completion of the regular local ring $\mathcal{O}_{\mathcal{X}, P}$ along its maximal ideal. Given a connected

reductive group G over F whose underlying F -variety is F -rational, Harbater-Hartmann-Krashen define a regular model $\mathcal{X} \rightarrow \text{Spec}(\mathcal{O})$ and patching fields $\{F_{U_i}, F_{P_j}\}$ with the property: the local global principle holds for certain classes of homogeneous spaces under G over F with respect to $\{F_{U_i}, F_{P_j}\}$. Using this local global principle, they provide a new proof of the following result due to Parimala-Suresh ([PS]): every quadratic form in at least 9 variables over function fields in one variable over non-dyadic p -adic fields has a nontrivial zero.

In ([CTPS]), the study of the local global principle for certain classes of homogeneous spaces under G over F with respect to discrete valuations of F is reduced to the study of a corresponding statement for the patching fields $\{F_{U_i}, F_{P_j}\}$. In particular, the Hasse principle for quadratic forms of dimension at least 3 over the function field of a p -adic curve ($p \neq 2$) with respect to all its discrete valuations is proved in ([CTPS] Thm. 3.1), which again yields $u(F) = 8$.

References

- [A] J.K. Arason, *Cohomologische Invarianten quadratischer Formen*, J. Algebra **36** (1975), 448–491.
- [AEJ1] J.K. Arason, R. Elman, and B. Jacob, *The graded Witt ring and Galois cohomology I*, Quadratic and Hermitian forms (Hamilton, Ont., 1983), 17–50, CMS Conf. Proc. **4**, Amer. Math. Soc., Providence, RI, 1984.
- [AEJ2] J.K. Arason, R. Elman, and B. Jacob, *Fields of cohomological 2-dimension three*, Math. Ann. **274** (1986), 649–657.
- [Ar] M. Artin, *Brauer-Severi varieties*, Brauer groups in ring theory and algebraic geometry, 194–210, Lecture Notes in Math. **917**, Springer, Berlin-New York, 1982.
- [B] H.J. Bartels, *Invarianten hermitescher Formen über Schiefkörpern*, Math. Ann. **215** (1975), 269–288.
- [BP1] E. Bayer-Fluckiger and R. Parimala, *Galois cohomology of the classical groups over fields of cohomological dimension ≤ 2* , Invent. Math. **122** (1995), 195–229.
- [BP2] E. Bayer-Fluckiger and R. Parimala, *Classical groups and the Hasse principle*, Ann. of Math. **147** (1998), 651–693. Erratum, Ann. of Math. **163** (2006), 381.
- [BFT] G. Berhuy, C. Frings and J.-P. Tignol, *Galois cohomology of the classical groups over imperfect fields*, J. of Pure and Appl. Algebra **211** (2007), 307–341.
- [Bo] M. Borovoi, *Abelian Galois cohomology of reductive groups*, Memoirs of the American Mathematical Society **132** (1998).
- [BKG] M. Borovoi, B. Kunyavskii, and P. Gille, *Arithmetical birational invariants of linear algebraic groups over two-dimensional geometric fields*, J. Algebra **276** (2004), 292–339.

- [BT] F. Bruhat and J. Tits, *Groupes réductifs sur un corps local. Chap. III. Compléments et applications à la cohomologie galoisienne*, J. Fasc. Sci. Tokyo **34** (1987), 671–698.
- [Ch1] V. Chernousov, *The Hasse principle for groups of type E_8* , Dokl. Akad. Nauk. SSSR **306** (1989), 1059–1063 and english transl. in Math. USSR-Izv. **34** (1990), 409–423.
- [Ch2] V. Chernousov, *The kernel of the Rost invariant, Serre’s Conjecture II and the Hasse principle for quasi-split groups ${}^3,6D_4, E_6, E_7$* , Math. Ann. **326** (2003), 297–330.
- [CM] V. Chernousov and A.S. Merkurjev, *R-equivalence and special unitary groups*, J. Algebra **209** (1998) 175–198.
- [CT] J.-L. Colliot-Thélène, *Résolutions flasques des groupes linéaires connexes*, J. reine angew. Math. **618** (2008), 77–133.
- [CTGP] J.-L. Colliot-Thélène, P. Gille and R. Parimala, *Arithmetic of linear algebraic groups over 2-dimensional geometric fields*, Duke Math. J. **121** (2004), 285–341.
- [CTK] J.-L. Colliot-Thélène and B. Kunyavskiĭ, *Groupe de Picard et groupe de Brauer des compactifications lisses d’espaces homogènes*, J. Algebraic Geom. **15** (2006), no. 4, 733–752.
- [CTOP] J.-L. Colliot-Thélène, M. Ojanguren and R. Parimala, *Quadratic forms over fraction fields of two-dimensional Henselian rings and Brauer groups of related schemes*, Algebra, arithmetic and geometry, Part I, II (Mumbai, 2000), 185–217, Tata Inst. Fund. Res. Stud. Math. **16** (2002), Bombay.
- [CTPS] J.-L. Colliot-Thélène, R. Parimala and V. Suresh, *Patching and local-global principle for homogenous spaces over function fields of p -adic curves*, to appear in Comm. Math. Helv.
- [CTS] J.-L. Colliot-Thélène et J.-J. Sansuc, *La R -équivalence sur les tores*, Ann. Sci. École Norm. Sup. 4ème série **10** (1977), 175–229.
- [EKL] H. Esnault, B. Kahn, M. Levine and E. Viehweg, *The Arason invariant and mod 2 algebraic cycles*, J. Amer. Math. Soc. **11** (1998), 73–118.
- [FS] T.J. Ford and D. Saltman, *Division algebras over Henselian surfaces*, Ring Theory 1989 (Ramat Gan Jerusalem, 1988/89) Israel Math. Conf. Proc. **1**, Weizmann, 1989, 320–336.
- [Ga1] S. Garibaldi, *The Rost invariant has trivial kernel for quasi-split groups of low rank*, Comment. Math. Helv. **76** (2001), 684–711.
- [Ga2] S. Garibaldi, *The Rost invariant has zero kernel for quasi-split triality groups*, preprint (2010), arXiv:1004.0663.
- [GMS] S. Garibaldi, A.S. Merkurjev and J.-P. Serre, *Cohomological invariants in Galois cohomology*, University Lecture Series **28**. Amer. Math. Soc. Providence (2003).
- [Gi1] P. Gille, *R -équivalence et principe de norme en cohomologie galoisienne*, C.R. Acad. Sci. Paris Sér. I Math. **316** (1993), 315–320.
- [Gi2] P. Gille, *La R -équivalence sur les groupes algébriques réductifs définis sur un corps global*, Inst. Hautes Études Sci. Publ. Math. **86** (1997), 199–235.

- [Gi3] P. Gille, *Invariants cohomologiques de Rost en caractéristique positive*, *K-Theory* **21** (2000), 57–100.
- [Gi4] P. Gille, *Cohomologie galoisienne des groupes quasi-déployés sur des corps de dimension cohomologique ≤ 2* , *Compositio Math.* **125** (2001), 283–325.
- [Gi5] P. Gille, *Serre’s Conjecture II: a survey*, *Quadratic Forms, Linear Algebraic Groups, and Cohomology*, Ed. J.-L. Colliot-Thélène, S. Garibaldi, R. Sujatha, and V. Suresh, *Developments in Mathematics* **18**, Springer-Verlag, 2010.
- [GQ] P. Gille and Anne Quéguiner-Mathieu, *Formules pour l’invariant de Rost*, preprint (2009).
- [HH] D. Harbater and J. Hartmann, *Patching over fields*, *Israel J. Math.* **176** (2010), 61–108.
- [HHK] D. Harbater, J. Hartmann and D. Krashen, *Applications of patching to quadratic forms and central simple algebras*, *Invent. Math.* **178** (2009), 231–263.
- [H1] G. Harder, *Über die Galoiskohomologie halbeinfacher Matrizen­gruppen I*, *Math. Z.* **90** (1965), 404–428, II, *Math. Z.* **92** (1966), 396–415.
- [H2] G. Harder, *Bericht über neuere Resultate der Galoiskohomologie halbeinfacher Gruppen*, *Jahresbericht der DMV* **70** (1968), 182–216.
- [H3] G. Harder, *Halbeinfache Gruppenschemata über vollständigen Kurven*, *Invent. Math.* **6** (1968) 107–149.
- [H4] G. Harder, *Über die Galoiskohomologie halbeinfacher Matrizen­gruppen III*, *J. für die reine angew. Math.* **274/5** (1975), 125–138.
- [Ja] P. Jaworski, *On the strong Hasse principle for fields of quotients of power series rings in two variables*, *Math. Z.* **236** (2001), 531–566.
- [dJ] A.J. de Jong, *The period-index problem for the Brauer group of an algebraic surface*, *Duke Mathematical Journal* **123** (2004), 71–94.
- [dJHS] A.J. de Jong, X. He and J.M. Starr, *Families of rationally simply connected varieties over surfaces and torsors for semisimple groups*, preprint (2008), arxiv:0809.5224.
- [K] B. Kahn, *Applications of weight-two motivic cohomology*, *Doc. Math.* **1** (1996), No. 17, 395–416.
- [Kn1] M. Kneser, *Galois-Kohomologie halbeinfacher algebraischer Gruppen über p -adischen Körpern I*, *Math.Z.* **88** (1965), 40–47, II *ibid* **89** (1965), 250–272.
- [Kn2] M. Kneser, *Lectures on Galois cohomology of classical groups*, Tata Institute of Fundamental Research, Bombay, 1969.
- [Kn3] M. Kneser, *Hasse principle for H^1 of simply connected groups*, *Algebraic Groups and Discontinuous Subgroups (Proc. Sympos. Pure Math., Boulder, CO, 1965)*, Amer. Math. Soc., Providence, RI, 1966.
- [KMRT] M.-A. Knus, A. Merkurjev, M. Rost and J.-P. Tignol, *The book of involutions, avec une préface de J. Tits*, American Mathematical Society Colloquium Publications **44**, 1998.

- [KRTY] B.E. Kunyavskii, L.H. Rowen, S.V. Tikhonov, and V.I. Yanchevskii, *Division Algebras that ramify only on a plane quartic curve*, Proc. Amer. Math. Soc. **134** (2006), 921–929.
- [LT] D.W. Lewis and J.-P. Tignol, *Classification theorems for central simple algebras with involution*, Manuscripta Math. **100** (1999), 259–276.
- [Li] M. Lieblich, *Twisted sheaves and the period-index problem*, Compos. Math. **144** (2008), no. 1, 1–31.
- [M1] A.S. Merkurjev, *Simple algebras and quadratic forms*, (Russian) Izv. Akad. Nauk SSSR Ser. Mat. **55** (1991), no. 1, 218–224; translation in Math. USSR-Izv. **38** (1992), no. 1, 215–221.
- [M2] A.S. Merkurjev, *The norm principle for algebraic groups*, (Russian) Algebra i Analiz **7** (1995), no. 2, 77–105; translation in St. Petersburg Math. J. **7** (1996), no. 2, 243–264.
- [MS] A.S. Merkurjev and A.A. Suslin, *\mathcal{K} -cohomology of Severi-Brauer varieties and norm residue homomorphism*, Izv. Akad. Nauk SSSR **46** (1982), 1011–1046, english translation: Math. USSR Izv. **21** (1983), 307–340.
- [PR] V. Platonov and A. Rapinchuk, *Algebraic groups and number theory*, Pure and Applied Mathematics **139**, Academic Press, Inc., Boston, MA, 1994.
- [PS] R. Parimala and V. Suresh, *The u -invariant of the function fields of p -adic curves*, to appear in Annals of Mathematics.
- [R] M. Rost, *A (mod 3) invariant for exceptional Jordan algebras*, C.R. Acad. Sci. Paris **315** (1991), 823–827.
- [S] D.J. Saltman, *Division Algebras over p -adic curves*, J. Ramanujan Math. Soc. **12** (1997), 25–47.
- [Sa] J.-J. Sansuc, *Groupe de Brauer et arithmétique des groupes algébriques linéaires*, J. reine angew. Math. **327** (1981), 12–80.
- [Sc] W. Scharlau, *Quadratic and hermitian forms*, Grundlehren der mathematischen Wissenschaften **270**, Springer-Verlag, 1985.
- [Sch] C. Scheiderer, *Hasse principles and approximation theorems for homogeneous spaces over fields of virtual cohomological dimension one*, Invent. Math. **125** (1996), 307–365.
- [Se1] J.-P. Serre, *Cohomologie galoisienne des groupes algébriques linéaires*, Colloque sur la théorie des groupes algébriques linéaires, Bruxelles (1962), 53–68.
- [Se2] J.-P. Serre, *Cohomologie galoisienne*, cinquième édition révisée et complétée, Lecture Notes in Math. **5**, Springer-Verlag, 1994.
- [Se3] J.-P. Serre, *Cohomologie galoisienne: Progrès et problèmes*, Séminaire Bourbaki, exposé 783 (1993–94), Astérisque **227** (1995).
- [SGA 4] M. Artin, A. Grothendieck et J.-L. Verdier, *Théorie des topos et cohomologie étale des schémas*, Lecture Notes in Mathematics **269**, **270**, **305**, Springer-Verlag, Berlin-New York, 1972–1973.
- [St] R. Steinberg, *Regular elements of semisimple algebraic groups*, Pub. Math. IHES **25** (1965), 281–312.

- [Su] A.A. Suslin, *Algebraic K-theory and the norm-residue homomorphism*, J. Soviet. Math. **30** (1985), 2556–2611.
- [V] M. Van den Bergh, *Division algebras on \mathbf{P}^2 of odd index, ramified along a smooth elliptic curve are cyclic*, Algèbre non commutative, groupes quantiques et invariants (Reims, 1995), 43–53, Sémin. Congr. **2**, Soc. Math. France, Paris, 1997.
- [Vo] V.E. Voskresenkiĭ, *O privedennoi grupe Uaitheida prostoi algebrы (On the Whitehead group of a simple algebra)*, Uspekhi Mat. Nauk. **32** (1977), 247–248.
- [Y] V.I. Yanchevskiĭ, *Commutants of simple algebras with a surjective reduced norm*, Dokl. Akad. Nauk SSSR **221** (1975) 1056–1058; engl. translation, Soviet Mat. Doklady **16** (1975), 492–495.

Representations of Higher Adelic Groups and Arithmetic

A.N. Parshin*

Abstract

We discuss the following topics: n -dimensional local fields and adelic groups; harmonic analysis on local fields and adelic groups for two-dimensional schemes (function spaces, Fourier transform, Poisson formula); representations of discrete Heisenberg groups; adelic Heisenberg groups and their representations arising from two-dimensional schemes.

Mathematics Subject Classification (2010). Primary 11G; 11S; 14G; 14K; 46F; Secondary 43A40.

Keywords. n -dimensional local field, adelic group, harmonic analysis, discrete Heisenberg group, induced representation, character, theta-function

What do we mean by local? To get an answer to this question let us start from the following two problems.

First problem is from number theory. When does the diophantine equation

$$f(x, y, z) = x^2 - ay^2 - bz^2 = 0, \quad a, b, \in \mathbb{Q}^*$$

have a non-trivial solution in rational numbers? In order to solve the problem, let us consider the quadratic norm residue symbol $(-, -)_p$ where p runs through all primes p and also ∞ . This symbol is a bi-multiplicative map $(-, -)_p : \mathbb{Q}^* \times \mathbb{Q}^* \rightarrow \{\pm 1\}$ and it is easily computed in terms of the Legendre symbol. Then, a non-trivial solution exists if and only if, for any p , $(a, b)_p = 1$. However,

*I am very thankful to Lawrence Breen, Denis V. Osipov, Vladimir L. Popov and Yuri G. Zarhin who have read the text and made many valuable remarks. The author was supported by RFBR (grant no. 08-01-00095-a).

Steklov Mathematical Institute, Russian Academy of Sciences, Gubkina str 8, 119991 Moscow, Russia. E-mail: parshin@mi.ras.ru

these conditions are not independent:

$$\prod_p (a, b)_p = 1. \quad (1)$$

This is essentially the Gauss reciprocity law in the Hilbert form.

The “points” p correspond to *all possible* completions of the field \mathbb{Q} of rational numbers, namely to the p -adic fields \mathbb{Q}_p and the field \mathbb{R} of real numbers. One can show that the equation $f = 0$ has a non-trivial solution in \mathbb{Q}_p if and only if $(a, b)_p = 1$.

The second problem comes from complex analysis. Let X be a compact Riemann surface (= complete smooth algebraic curve defined over \mathbb{C}). For a point $P \in X$, denote by $K_P = \mathbb{C}((t_P))$ the field of Laurent formal power series in a local coordinate t_P at the point P . The field K_P contains the ring $\hat{\mathcal{O}}_P = \mathbb{C}[[t_P]]$ of Taylor formal power series. These have an invariant meaning and are called the local field and the local ring at P respectively. Let us now fix finitely many points $P_1, \dots, P_n \in X$ and assign to every P in X some elements f_P such that $f_{P_1} \in K_{P_1}, \dots, f_{P_n} \in K_{P_n}$ and $f_P = 0$ for all other points.

When does there exist a meromorphic (=rational) function f on X such that

$$f_P - f \in \hat{\mathcal{O}}_P \quad \text{for every } P \in X? \quad (2)$$

The classical answer to this Cousin problem is the following: there exists such an f whenever for any regular differential form ω on X

$$\sum_P \text{res}_P(f_P \omega) = 0. \quad (3)$$

The space of regular differential forms has dimension g (= genus of X) and in this way one gets finitely many conditions on the data (f_P) . The residue is an additive map $\text{res}_P : \Omega^1(K_P) \rightarrow \mathbb{C}$ and is easily computed in terms of the local decomposition of the differential form $\omega \in \Omega^1(K_P)$. Note that “locally”, problem (2) can be solved for any point P . Behind our global conditions (3), we have the following residue relation:

$$\sum_P \text{res}_P(\eta) = 0 \quad (4)$$

for any *meromorphic* differential form η on X .

We see some similarity between these two problems, which belong to very different parts of our science. The explanation lies in the existence of a very deep analogy between numbers and functions, between number fields and fields of algebraic functions. This analogy goes back to the nineteenth century, possibly to Kronecker. The leading role in the subsequent development belongs to Hilbert. The analogy was one of his beloved ideas, and thanks to Hilbert it became one of the central ideas in the development of number theory during the twentieth century. Following this analogy, we can compare algebraic curves

over \mathbb{C} (= compact Riemann surfaces) and number fields (= finite extensions of \mathbb{Q}). In particular, this includes a comparison of *local* fields such as that between the fields $\mathbb{C}((t))$ and \mathbb{Q}_p . Their similarity was already pointed out by Newton¹.

In modern terms, we have two kinds of geometric objects. First, a complete algebraic curve X , containing an affine curve $U = \text{Spec}(R)$ ², where R is the ring of regular functions on U :

(geometric picture) $X \supset U$ and finitely many points $P \in X$.

Next, if we turn to arithmetic, we have a finite extension $K \supset \mathbb{Q}$ and the ring $R \subset K$ of integers. We write

(arithmetic picture) $X \supset U = \text{Spec}(R)$ and finitely many infinite places $P \in X$.

The places (“points”) correspond to the embeddings of K into the fields \mathbb{R} or \mathbb{C} . Here, X stands for the as yet not clearly defined complete “arithmetical” curve, an analogue of the curve X in the geometric situation. The analogy between both U ’s is very clear and transparent. The rings R are the Dedekind rings of the Krull dimension³ 1. The nature of the additional points (outside U) are more complicated. In the geometric case, they also correspond to the non-archimedean valuations on the curve X , whereas in the arithmetical case these infinite places are a substitute for the archimedean valuations of the field K .

In algebraic geometry, we also have the theory of algebraic curves defined over a finite field \mathbb{F}_q and this theory, being arithmetic in its nature, is much closer to the theory of number fields than the theory of algebraic curves over \mathbb{C} . The main construction on both sides of the analogy is the notion of a local field. These local fields appear into the following table:

dimension	geometric case	arithmetic case
> 2
2	?	$\mathbb{R}((t)), \mathbb{C}((t))$
1	$\mathbb{F}_q((t))$	$\mathbb{Q}_p, \mathbb{R}, \mathbb{C}$
0	\mathbb{F}_q	\mathbb{F}_1

Here \mathbb{F}_1 is the so-called “field” with one element, which is quite popular nowadays. We will see soon why the fields $\mathbb{R}((t))$ and $\mathbb{C}((t))$ belong to the higher level of the table than the fields \mathbb{Q}_p or \mathbb{R} . More on the analogy between geometry and arithmetic can be found in [61].

¹He compared the power series and the expansions of rational numbers in powers of p (for $p = 10$).

²Here, $\text{Spec}(R)$ is the set of prime ideals in the ring R together with the additional structure of a scheme.

³That is, the length of a maximal chain of prime ideals. The ring R itself is not a prime ideal.

1. n -dimensional Local Fields and Adelic Groups

Let us consider algebraic varieties X (or Grothendieck schemes) of dimension greater than one. It appears that we have a well established notion of something local attached to a point $P \in X$. One can take a neighborhood of P , e.g. affine, complex-analytic if X is defined over \mathbb{C} , formal and so on. In this talk we will advocate the viewpoint that the genuine local objects on the varieties are not the points with some neighborhoods but the maximal ordered sequences (or flags) of subvarieties, ordered by inclusion.

If X is a variety (or a scheme) of dimension n and

$$X_0 \subset X_1 \subset \dots \subset X_{n-1} \subset X_n = X$$

is a flag of irreducible subvarieties ($\dim(X_i) = i$) then one can define a certain ring

$$K_{X_0, \dots, X_{n-1}}$$

associated to the flag. In the case where all the subvarieties are regularly embedded, this ring is an n -dimensional local field.

Definition 1. Let K and k be fields. We say that K has a structure of an n -dimensional local field with the last residue field k if either $n = 0$ and $K = k$ or $n \geq 1$ and K is the fraction field of a complete discrete valuation ring \mathcal{O}_K whose residue field \bar{K} is a local field of dimension $n - 1$ with the last residue field k .

Thus, an n -dimensional local field has the following inductive structure:

$$K =: K^{(0)} \supset \mathcal{O}_K \rightarrow \bar{K} =: K^{(1)} \supset \mathcal{O}_{\bar{K}} \rightarrow \bar{K}^{(1)} =: K^{(2)} \supset \mathcal{O}_{K^{(2)}} \rightarrow \dots \rightarrow \bar{K}^{(n)} = k$$

where \mathcal{O}_F denotes the valuation ring of the valuation on F and \bar{F} denotes the residue field.

The simplest example of an n -dimensional local field is the field

$$K = k((t_1))((t_2)) \dots ((t_n))$$

of iterated Laurent formal power series. In dimension one, there are examples from the table. However, fields such as \mathbb{R} or \mathbb{C} are not covered by this definition. Concerning classification of the local fields see [17].

One can then form the adelic group (actually, the ring)

$$\mathbb{A}_X = \prod' K_{X_0, \dots, X_{n-1}}$$

where the product is taken over all the flags with respect to certain restrictions on components of adeles. For schemes over a finite field \mathbb{F}_q , this is the ultimate

definition of the adelic space attached to X . In general, one must extend it by adding archimedean components, such as the fields \mathbb{R} or \mathbb{C} in dimension one.

In dimension one, the local fields and adelic groups are well-known tools of arithmetic. They were introduced by C. Chevalley in the 1930s and were used to formulate and solve many problems in number theory and algebraic geometry (see, for example, [1, 74]). These constructions are associated with fields of algebraic numbers and fields of algebraic functions in one variable over a finite field, that is with schemes of dimension 1. A need for such constructions in higher dimensions was realized by the author in the 1970s. They were developed in the local case for any dimension and in the global case for dimension two [53, 54, 17, 58]. This approach was extended by A. A. Beilinson to the schemes of an arbitrary dimension [3, 25]. In this talk, we restrict ourselves to the case of dimension two.

Let X be a smooth irreducible surface over a field k (or an arithmetic surface), let P be a closed point of X and let $C \subset X$ be an irreducible curve such that $P \in C$. We denote by $\mathcal{O}_{X,P}$ the local ring at the point P , that is the ring of rational functions which are regular at P . We denote also by \mathcal{O}_C the ring of rational functions on X which have no pole along the C .

If X and C are smooth at P , then we pick a local equation $t \in \mathcal{O}_{X,P}$ of C at P and choose $u \in \mathcal{O}_{X,P}$ such that $u|_C \in \mathcal{O}_{C,P}$ is a local parameter at P . Denote by \wp the ideal in $\mathcal{O}_{X,P}$ defining the curve C near P . We can introduce a two-dimensional local field $K_{P,C}$ attached to the pair P, C by the following procedure which includes completions and localizations:

$$\begin{array}{lcl}
 \mathcal{O}_{X,P} & & \\
 \downarrow & & \\
 \widehat{\mathcal{O}}_{X,P} & = & k(P)[[u, t]] \supset \wp = (t) \\
 \downarrow & & \\
 (\widehat{\mathcal{O}}_{X,P})_{\wp} & = & \text{discrete valuation ring with residue field } k(P)((u)) \\
 \downarrow & & \\
 \widehat{\mathcal{O}}_{P,C} := \widehat{(\widehat{\mathcal{O}}_{X,P})_{\wp}} & = & k(P)((u))[[t]] \\
 \downarrow & & \\
 K_{P,C} := \text{Frac}(\widehat{\mathcal{O}}_{P,C}) & = & k(P)((u))((t))
 \end{array}$$

Note that the left-hand construction is meaningful even *without* smoothness of the curve C (it is sufficient to assume that C has only one formal branch near P). In the general case, the ring $K_{P,C}$ is a finite direct sum of 2-dimensional local fields. If P is smooth then the field $K_{P,C}$ has the following informal interpretation. Take a function f on X . We can, first, develop f as a formal power series in the variable t along the curve C and then every coefficient of the series restricted to C can be further developed as a formal power series in the variable u . The local field $K_{P,C}$ is a kind of completion of the field of rational functions $k(X)$ on X . It carries a discrete valuation $\nu_C : K_{P,C}^* \rightarrow \mathbb{Z}$ defined by the powers of the ideal \wp .

Let K_P be the minimal subring of $K_{P,C}$ which contains both $K = k(X)$ and $\widehat{\mathcal{O}}_{X,P}$. In general, the ring K_P is not a field. Then $K \subset K_P \subset K_{P,C}$ and there is another intermediate subring $K_C = \text{Frac}(\widehat{\mathcal{O}}_C) \subset K_{P,C}$. We can compare the structure of the local adelic components in dimensions one and two:

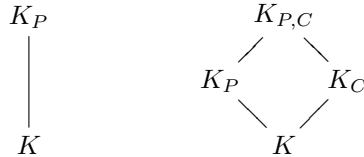

The global adelic group is a certain subgroup of the ordinary product of all two-dimensional local fields. Namely, a collection $(f_{P,C})$ where $f_{P,C} \in K_{P,C}$ belongs to \mathbb{A}_X if the following two conditions are satisfied:

- $\{f_{P,C}\} \in \mathbb{A}_C((t_C))$
for a fixed irreducible curve $C \subset X$ and a local equation $t_C = 0$ of the curve C on some open affine subset $U \subset X$ and

- we have $\nu_C(f_{P,C}) \geq 0$, or equivalently

$$\{f_{P,C}\} \in \mathbb{A}_C[[t_C]],$$

for all but finitely many irreducible curves $C \subset X$.

Here we reduced the definition of the adelic group to the classical case of algebraic curves C . Recall that a collection $(f_P, P \in C)$ belongs to the adelic (or restricted) product \mathbb{A}_C of the local fields K_P if and only if for almost all points P we have $f_P \in \widehat{\mathcal{O}}_P$.

What can one do with this notion of the local field and why is it really local? To get some understanding of this, we would like to develop the above examples (of residues and symbols) in dimension two. For any flag $P \in C$ on a surface X and a rational differential form ω of degree 2 we can define the residue

$$\text{res}_{P,C}(\omega) = \text{Tr}_{k(P)/k}(a_{-1,-1})$$

where $\omega = \sum_{i,j} a_{i,j} u^i t^j du \wedge dt$ in the field $K_{P,C} \cong k(P)((u))((t))$. Then, instead of the simple relation (4) on an algebraic curve, we get two types of relations on the projective surface X [54]

$$\sum_{P \in C} \text{res}_{P,C}(\omega) = 0, \quad \text{for any fixed curve } C, \tag{5}$$

$$\sum_{C \ni P} \text{res}_{P,C}(\omega) = 0, \quad \text{for any fixed point } P. \tag{6}$$

At the same time, we can define certain symbols (bi-multiplicative and three-multiplicative) [53]

$$(-, -)_{P,C} : K_{P,C}^* \times K_{P,C}^* \rightarrow \mathbb{Z} \quad \text{and} \quad (-, -, -)_{P,C} : K_{P,C}^* \times K_{P,C}^* \times K_{P,C}^* \rightarrow k^*$$

which are respectively generalizations of the valuation $\nu_P : K_P^* \rightarrow \mathbb{Z}$ and the norm residue symbol $(-, -)_P : K_P^* \times K_P^*$ (actually, the tame symbol) on an algebraic curve C . The reciprocity laws have the same structure as the residue relations. In particular, if $f, g, h \in K^*$ then

$$\prod_{P \in C} (f, g, h)_{P,C} = 1, \quad \text{for any fixed curve } C,$$

$$\prod_{C \ni P} (f, g, h)_{P,C} = 1, \quad \text{for any fixed point } P.$$

This shows that in dimension two there is a symmetry between points P and curves C (which looks like the classical duality between points and lines in projective geometry).

If C is a curve then the space \mathbb{A}_C contains the important subspaces $\mathbb{A}_0 = K = k(C)$ of principal adèles (rational functions diagonally embedded into the adelic group) and $\mathbb{A}_1 = \prod_{P \in C} \widehat{\mathcal{O}}_P$ of integral adèles. These give rise to the adelic complex

$$\mathbb{A}_0 \oplus \mathbb{A}_1 \rightarrow \mathbb{A}_C. \tag{7}$$

This complex computes the cohomology of the structure sheaf \mathcal{O}_C . If D is a divisor on C then the cohomology of the sheaf $\mathcal{O}_C(D)$ can be computed using the adelic complex (7) where the subgroup \mathbb{A}_1 is replaced by the subgroup $\mathbb{A}_1(D) = \{(f_P) \in \mathbb{A}_C : \nu_P(f_P) + \nu_P(D) > 0 \text{ for any } P \in C\}$.

In dimension two, there is a much more complicated structure of subspaces in \mathbb{A}_X (see [58]). Among the others, it includes three subspaces $\mathbb{A}_{12} = \prod'_{P \in C} \widehat{\mathcal{O}}_{P,C}$, $\mathbb{A}_{01} = \prod'_{C \subset X} K_C$ and $\mathbb{A}_{02} = \prod'_{P \in X} K_P$. We set $\mathbb{A}_0 = \mathbb{A}_{01} \cap \mathbb{A}_{02}$, $\mathbb{A}_1 = \mathbb{A}_{01} \cap \mathbb{A}_{12}$ and $\mathbb{A}_2 = \mathbb{A}_{02} \cap \mathbb{A}_{12}$, and arrive at an adelic complex

$$\mathbb{A}_0 \oplus \mathbb{A}_1 \oplus \mathbb{A}_2 \rightarrow \mathbb{A}_{01} \oplus \mathbb{A}_{02} \oplus \mathbb{A}_{12} \rightarrow \mathbb{A}_X.$$

Once again, the complex computes the cohomology of the sheaf \mathcal{O}_X . One can extend these complexes to the case of arbitrary schemes X and any coherent sheaf on X (see [3, 25, 17]).

The last issue which we will discuss in this section is the relation between the residues and Serre duality for coherent sheaves. We will only consider the construction of the fundamental class for the sheaf of differential forms. For curves C , we have an isomorphism $H^1(C, \Omega_C^1) \cong \Omega^1(\mathbb{A}_C) / \Omega^1(\mathbb{A}_0) \oplus \Omega^1(\mathbb{A}_1)$. The fundamental class isomorphism $H^1(C, \Omega_C^1) \cong k$ can be defined as the sum of residues on $\Omega^1(\mathbb{A}_C)$. The residues relation (3) shows that this sum vanishes on the subspace $\Omega^1(\mathbb{A}_0)$ (and it vanishes on the other subspace $\Omega^1(\mathbb{A}_1)$ for

trivial reasons). The same reasoning works in the case of surfaces. We have an isomorphism

$$H^2(C, \Omega_X^2) \cong \Omega^2(\mathbb{A}_X)/\Omega^2(\mathbb{A}_{01}) \oplus \Omega^2(\mathbb{A}_{02}) \oplus \Omega^2(\mathbb{A}_{12}) \rightarrow k,$$

where the last arrow is again the sum of residues over all flags $P \in C \subset X$. The correctness of this definition follows from the residues relations (5) and (6). We refer to [54, 3, 17] for the full description of the duality.

2. Harmonic Analysis on Two-dimensional Schemes

In the 1-dimensional case, local fields and adelic groups both carry a natural topology for which they are locally compact groups and classical harmonic analysis on locally compact groups can therefore be applied to this situation. The study of representations of algebraic groups over local fields and adelic groups is a broad subfield of representation theory, algebraic geometry and number theory. Even for abelian groups, this line of thought has very nontrivial applications in number theory, particularly to the study of L-functions of one-dimensional schemes (see below). The first preliminary step is the existence of a Haar measure on locally compact groups. The analysis starts with a definition of certain function spaces.

We have two sorts of locally compact groups. The groups of the first type are totally disconnected such as the fields \mathbb{Q}_p or $\mathbb{F}_q((t))$. These groups are related with varieties defined over a finite field. The groups of the second type are connected Lie groups such as the fields \mathbb{R} or \mathbb{C} .

If V is a locally compact abelian group of the first type let us consider the following spaces of functions (or distributions) on V :

$$\begin{aligned} \mathcal{D}(V) &= \{\text{locally constant functions with compact support}\} \\ \tilde{\mathcal{E}}(V) &= \{\text{uniformly locally constant functions}\} \\ \mathcal{E}(V) &= \{\text{all locally constant functions}\} \\ \mathcal{D}'(V) &= \{\text{the dual to } \mathcal{D}(V), \text{ i.e. all distributions}\} \\ \tilde{\mathcal{E}}'(V) &= \{\text{the “continuous” dual to } \tilde{\mathcal{E}}(V)\} \\ \mathcal{E}'(V) &= \{\text{the “continuous” dual to } \mathcal{E}(V), \text{ i.e. distributions with compact support}\}. \end{aligned}$$

These are the classical spaces introduced by F. Bruhat [10] and the more powerful way to develop the harmonic analysis is the categorical point of view. First, we need definitions of direct and inverse images with respect to the continuous homomorphisms.

Let $f : V \rightarrow W$ be a strict homomorphism⁴ of locally compact groups V and W . Then the inverse image $f^* : \mathcal{D}(W) \rightarrow \mathcal{D}(V)$ is defined if and only if the

⁴This means that f is a composition of an open epimorphism and a closed monomorphism.

kernel of f is compact. The direct image $f_* : \mathcal{D}(V) \otimes \mu(V) \rightarrow \mathcal{D}(W)$ is defined if and only if the cokernel of f is discrete. Here, $\mu(V)$ is a (1-dimensional) space of Haar measures on V . For the spaces like $\mathcal{E}, \tilde{\mathcal{E}}$ the inverse image is defined for any f , but the direct image is defined if and only if the kernel is compact and the cokernel is discrete. For the distribution spaces the corresponding conditions are the dual ones. Therefore, we see that these maps do not exist for arbitrary homomorphisms in our category and there are some “selection rules”.

The Fourier transform F is defined as a map from $\mathcal{D}(V) \otimes \mu(V)$ to $\mathcal{D}(\check{V})$ as well as for the other types of spaces. Here, \check{V} is the dual group. The main result is the following Poisson formula

$$F(\delta_{W, \mu_0} \otimes \mu) = \delta_{W^\perp, \mu^{-1}/\mu_0^{-1}}$$

for any closed subgroup $i : W \rightarrow V$. Here $\mu_0 \in \mu(W) \subset \mathcal{D}'(W)$, $\mu \in \mu(V) \subset \mathcal{D}'(V)$, $\delta_{W, \mu_0} = i_*(1_W \otimes \mu_0)$ and W^\perp is the annihilator of W in V .

This general formula is very efficient when applied to the *self-dual* (!) group \mathbb{A}_C . The standard subgroups in \mathbb{A}_C have their characteristic functions $\delta_{\mathbb{A}_1(D)} \in \mathcal{D}(\mathbb{A}_C)$ and $\delta_K \in \mathcal{D}'(\mathbb{A}_C)$. We have

$$F(\delta_{\mathbb{A}_1(D)}) = \text{vol}(\mathbb{A}_1(D)) \delta_{\mathbb{A}_1((\omega)-D)}, \quad (8)$$

$$F(\delta_K) = \text{vol}(\mathbb{A}_C/K)^{-1} \delta_K, \quad (9)$$

where $K = \mathbb{F}_q(C)$ and (ω) is the divisor of a nonzero rational differential form $\omega \in \Omega_K^1$ on C . There is the Plancherel formula $\langle f, g \rangle = \langle F(f), F(g) \rangle$ where $f \in \mathcal{D}(\mathbb{A}_C)$, $g \in \mathcal{D}'(\mathbb{A}_C)$ and $\langle -, - \rangle$ is the canonical pairing between dual spaces. When we apply this formula to the characteristic functions $\delta_{\mathbb{A}_1(D)}$ and δ_K the result easily yields Riemann-Roch theorem together with Serre duality for divisors on C (see for example [58]).

Trying to extend the harmonic analysis to the higher local fields and adelic groups we meet the following obstacle. The n -dimensional local fields and consequently the adelic groups are not locally compact topological groups for $n > 1$ in any reasonable sense whereas by a theorem of Weil the existence of Haar measure (in the usual sense) on a topological group implies its local compactness. Unfortunately, the well-known extensions of this measure theory to the infinite-dimensional spaces or groups (such as the Wiener measure) do not help in our circumstances. Thus, we have to develop a measure theory and harmonic analysis on n -dimensional local fields and adelic groups *ab ovo*.

The idea for dealing with this problem came to me in the 1990s. In dimension one, local fields and adelic groups are equipped with a natural filtration provided by fractional ideals φ^n , $n \in \mathbb{Z}$, which correspond to the standard valuations. For example, this filtration on the field $\mathbb{F}_q((t))$ is given by the powers of t . If $P \supset Q$ are two elements of such a filtration on a group V , then the Bruhat space $\mathcal{D}(V)$ is canonically isomorphic to the double inductive limit of the (finite-dimensional) spaces $\mathcal{F}(P/Q)$ of all functions on the finite groups P/Q . The other function

spaces listed above can be represented in the same way if we use all possible combinations of projective or inductive limits.

In dimension two, local fields K such as $K_{P,C}$ again have a filtration by fractional ideals, which are powers of \wp . But now, the quotient $P/Q = \wp^m/\wp^n, n > m$ will be isomorphic to a direct sum of finitely many copies of the residue field $\bar{K} = \mathbb{F}_q((u))$. Thus this group is locally compact and the functional space $\mathcal{D}(P/Q)$ is well defined. To define the function spaces on K one can try to repeat the procedure which we know for the 1-dimensional fields. To do that, we need to define the maps (direct or inverse images) between the spaces $\mathcal{D}(P/Q), \mathcal{D}(P/R), \mathcal{D}(Q/R)$ for $P \supset Q \supset R$. The selection rules mentioned above restrict the opportunities for this construction. This enables us to introduce the following six types of spaces of functions (or distributions) on V :

$$\begin{aligned}
 \mathcal{D}_{P_0}(V) &= \lim_{\leftarrow} \lim_{\leftarrow} \mathcal{D}(P/Q) \otimes \mu(P_0/Q), \\
 &\quad \quad \quad j^* \quad i_* \\
 \mathcal{D}'_{P_0}(V) &= \lim_{\rightarrow} \lim_{\rightarrow} \mathcal{D}'(P/Q) \otimes \mu(P_0/Q)^{-1}, \\
 &\quad \quad \quad j_* \quad i^* \\
 \mathcal{E}(V) &= \lim_{\leftarrow} \lim_{\rightarrow} \mathcal{E}(P/Q), \\
 &\quad \quad \quad j^* \quad i^* \\
 \mathcal{E}'(V) &= \lim_{\rightarrow} \lim_{\leftarrow} \mathcal{E}'(P/Q), \\
 &\quad \quad \quad j_* \quad i_* \\
 \tilde{\mathcal{E}}(V) &= \lim_{\rightarrow} \lim_{\leftarrow} \tilde{\mathcal{E}}(P/Q), \\
 &\quad \quad \quad i^* \quad j^* \\
 \tilde{\mathcal{E}}'(V) &= \lim_{\leftarrow} \lim_{\rightarrow} \tilde{\mathcal{E}}'(P/Q), \\
 &\quad \quad \quad i_* \quad j_*
 \end{aligned}$$

where $P \supset Q \supset R$ are some elements of the filtration in V (with locally compact quotients), P_0 is a fixed subgroup from the filtration and $j : Q/R \rightarrow P/R, i : P/R \rightarrow P/Q$ are the canonical maps.

This definition works for a general class of groups V including the adelic groups such as \mathbb{A}_X , which has a filtration by the subspaces $\mathbb{A}_{12}(D)$ where D runs through the Cartier divisors on X .

Thus, developing of harmonic analysis may start with the case of dimension zero (finite-dimensional vector spaces over a finite field representing a scheme of dimension zero, such as $\text{Spec}(\mathbb{F}_q)$, or finite abelian groups) and then be extended by induction to the higher dimensions.

An important contribution was made in 2001 by Michael Kapranov [33] who suggested using a trick from the construction of the Sato Grassmanian in the theory of integrable systems (known as a construction of semi-infinite monomials)⁵. The idea consists of using the spaces $\mu(P_0/Q)$ of measures instead of $\mu(P/Q)$ in the above definition of the spaces $\mathcal{D}_{P_0}(V)$ and $\mathcal{D}'_{P_0}(V)$: without

⁵A construction of this kind for the local fields is also contained in [35].

it one cannot define the functional spaces for *all* adelic groups in the two-dimensional case and, in particular, for the whole adelic space \mathbb{A}_X .

In 2005 Denis Osipov has introduced the notion of a C_n structure in the category of filtered vector spaces [49]. With this notion at hand, harmonic analysis can be developed in a very general setting, for all objects of the category C_2 . The crucial point is that the C_n -structure exists for the adelic spaces of *any* n -dimensional noetherian scheme. The principal advantage of this approach is that one can perform all the constructions *simultaneously* in the local and global cases. The category C_1 contains (as a full subcategory) the category of linearly locally compact vector spaces (introduced and thoroughly studied by S. Lefschetz [42]) and there one can use the classical harmonic analysis.

When we go to general arithmetic schemes over $\text{Spec}(\mathbb{Z})$, fields like $\mathbb{C}((t_1)) \dots ((t_n))$ appear and we need to extend the basic category C_n . In dimension one, this means that connected Lie groups must also be considered. It is possible to define categories of filtered abelian groups C_n^{ar} , ($n = 0, 1, 2$), which contain all types of groups which arise from arbitrary schemes of dimension 0, 1 and 2 (in particular from algebraic surfaces over \mathbb{F}_q and arithmetic surfaces). Harmonic analysis can be developed for these categories if we introduce function spaces which are close to that of classical functional analysis, such as Schwartz space $\mathcal{S}(\mathbb{R})$ of smooth functions on \mathbb{R} , which are rapidly decreasing together with all their derivatives. Recall that in the case of dimension one we had to consider, in addition to the genuine local fields such as \mathbb{Q}_p , the fields \mathbb{R} and \mathbb{C} . In the next dimension, we have to add to the two-dimensional local fields such as $\mathbb{F}_q((u))((t))$ or $\mathbb{Q}_p((t))$ the fields $\mathbb{R}((t))$ and $\mathbb{C}((t))$. They will occupy the entire row in the table above. This theory has been developed in papers [50, 51].

Just as in the case of dimension one, we define direct and inverse images in the categories of groups, which take into account all the components of the adelic complex, the Fourier transform F which preserves the spaces \mathcal{D} and \mathcal{D}' but interchanges the spaces \mathcal{E} and \mathcal{E}' . We also introduce the characteristic functions δ_W of subgroups W and then prove a generalization of the Poisson formula. It is important that for a certain class of groups V (but not for \mathbb{A}_X itself) there exists a nonzero invariant measure, defined up to multiplication by a constant, which is an element of $\mathcal{D}'(V)$. Another important tool of the theory are the base change theorems for the inverse and direct images. They are function-theoretic counterparts of the classical base change theorems in the categories of coherent sheaves.

The applications of the theory includes an analytic expression for the intersection number of two divisors based on an adelic approach to the intersection theory [55] and an analytic proof of the (easy part of) Riemann-Roch theorem for divisors on X .

This theory is the harmonic analysis on the additive groups of the local fields and adelic rings (including their archimedean cousins). In the classical case of dimension one, the analysis can be developed on arbitrary varieties (defined

either over K , or over \mathbb{A}). This has already been done by Bruhat in the local case [10]. For arbitrary varieties defined over a two-dimensional local field K , this kind of analysis was carried out by D. Gaitsgory and D. A. Kazhdan in [18] for the purposes of representation theory of reductive groups over the field K . This was preceded by a construction [34] of harmonic analysis on homogenous spaces such as $G(K)/G(\mathcal{O}_K)$ (introduced in [56]). We note that the construction of harmonic analysis (over K and \mathbb{A}) is a nontrivial problem even in the case $G = \mathbb{G}_m$. This will be the topic of our discussion in the following sections.

3. Discrete Adelic Groups on Two-dimensional Schemes

The harmonic analysis discussed above can be viewed as a representation theory of the simplest algebraic group over local or adelic rings, namely, of the additive group. In general, 1-dimensional local fields and adelic rings lead to a vastly developed representation theory of reductive groups over these fields and rings. The simplest case of this theory is still the case of an abelian group, namely $GL(1)$. Let K be a local field of dimension 1. Then $GL(1, K) = K^*$, the multiplicative group of K , and the irreducible representations are the abelian characters, i.e. continuous homomorphisms $\chi : K^* \rightarrow \mathbb{C}^*$. For arithmetic applications one requires the morphisms to \mathbb{C}^* , not to the unitary group $U(1) \subset \mathbb{C}^*$.

The 1-dimensional local field K contains a discrete valuation subring \mathcal{O} with a maximal ideal φ . Then the local group K^* has the following structure

$$K^* = \{t^n, n \in \mathbb{Z}\} \times \mathcal{O}^* = \{t^n, n \in \mathbb{Z}\} \times \bar{K}^* \times \{1 + \varphi\},$$

where t is a generator of the ideal φ , $\bar{K} = \mathbb{F}_q$ and the group $\{1 + \varphi\}$ is the projective limit of its finite quotients $\{1 + \varphi\}/\{1 + \varphi^n\}$. Thus, our group K^* is a product of the maximal compact subgroup \mathcal{O}^* and a discrete group $\cong \mathbb{Z}$. When K is the local field K_P attached to a point P of an algebraic curve C defined over a finite field \mathbb{F}_q , let us set $\Gamma_P := K_P^*/\mathcal{O}_P^*$. In the adelic case, we set

$$\Gamma_C := \mathbf{A}_C^*/\prod_P \mathcal{O}_P^* = \bigoplus_P K_P^*/\mathcal{O}_P^* = \bigoplus_P \mathbb{Z}.$$

This group is the group of divisors on C .

We now introduce the groups dual to these discrete groups viewing them as algebraic groups defined over \mathbb{C} :

$$\mathbb{T}_P = \text{Hom}(\Gamma_P, \mathbb{C}^*), \quad \mathbb{T}_S = \prod_{P \in S} \mathbb{T}_P, \quad \mathbb{T}_C = \varprojlim_S \mathbb{T}_S,$$

where S runs through all finite subsets in C . Let us consider the divisor D_S with normal crossings on \mathbb{T}_S that consists of the points in the product \mathbb{T}_S for

which at least one component is the identity point in some \mathbb{T}_P . Let $\mathbb{C}_+[\mathbb{T}_S]$ be the space of rational functions on \mathbb{T}_S that are regular outside D_S and may have poles of first order on D_S . The space $\mathbb{C}_+[\mathbb{T}_C]$ can be defined as an inductive limit with respect to the obvious inclusions.

We would like to show that harmonic analysis on the adelic space \mathbb{A}_C can be reformulated in terms of complex analysis on the dual groups. We need one more torus $\mathbb{T}_0 \cong \mathbb{C}^*$, which corresponds by the duality to the image of the degree map

$$\text{deg} : \Gamma_C \rightarrow \mathbb{Z} \quad \text{with} \quad \text{deg}(D) = \sum_P n_P \text{deg}(P) \text{ for a divisor } D = \sum_P n_P P.$$

Denote by $j : \mathbb{T}_0 \rightarrow \mathbb{T}_C$ the natural embedding. Then the following diagram

$$\begin{CD} \mathcal{D}(\mathbb{A}_C)^{\mathcal{O}^*} =: \mathcal{D}_+(\Gamma_C) @>\mathcal{L}>> \mathbb{C}_+[\mathbb{T}_C] @>j^*>> \mathcal{F}_+[\mathbb{T}_0] \\ @. @VVV @VVi^*V \\ \mathcal{D}(\mathbb{A}_C)^{\mathcal{O}^*} =: \mathcal{D}_+(\Gamma_C) @>\mathcal{L}>> \mathbb{C}_+[\mathbb{T}_C] @>j^*>> \mathcal{F}_+[\mathbb{T}_0] \end{CD} \tag{10}$$

commutes. Here, the map F is induced by the Fourier transform on the adelic group \mathbb{A}_C , the map $i : \mathbb{T}_0 \rightarrow \mathbb{T}_0$ sends $z \in \mathbb{T}_0$ to $q^{-1}z^{-1}$ and the space $\mathcal{F}_+[\mathbb{T}_0]$ consists of the functions that are regular outside the points $z = 1$ and $z = q^{-1}$ and may have poles of the first order at these points. We denoted here by \mathcal{L} a duality map, a version of the Fourier transform in this situation (completely different however from the Fourier map F). If $g \in G$ and $z \in \mathbb{T}_G = \text{Hom}(G, \mathbb{C}^*)$ for some group G then $(\mathcal{L}f)(z) = \sum_g f(g)z(g)$.

The next important fact is a reformulation of the Poisson formula on the group \mathbb{A}_C ⁶. It can be shown that for any function $f \in \mathcal{D}(\mathbb{A}_C)^{\mathcal{O}^*}$

$$\sum_{\gamma \in K} f(\gamma) = \text{res}_{(0)}(\omega) + \text{res}_{(1)}(\omega),$$

$$\sum_{\gamma \in K} (Ff)(\gamma) = -\text{res}_{(q^{-1})}(\omega) - \text{res}_{(\infty)}(\omega),$$

where $\omega = j^* \mathcal{L}f dz/z$ is the differential form on the compactification of the torus \mathbb{T}_0 and the points we have chosen for the residues are $z = 0, z = q^{-1}, z = 1$ and $z = \infty$. Since the poles of the form ω are contained in this set, we deduce that the Poisson formula on the curve C (with an appropriate choice of Haar measure on \mathbb{A}_C) is equivalent to the residue formula (4) for the form ω on the compactification of the torus \mathbb{T}_0 (the general case see in [62]).

Our main goal now is to understand what correspond to these constructions in the case of dimension two⁷. Let us first consider the local situation, that is

⁶For the sake of simplicity, we assume that $\text{Pic}^0(C)(\mathbb{F}_q) = (0)$, that is $\text{Ker}(\text{deg}) = \text{Div}_1(C)$.

⁷We consider here the case of an algebraic surface. The main definitions remain valid for the scheme part of an arithmetic surface.

we fix a flag $P \in C$ on X and assume, for the sake of simplicity, that P is a smooth point on C . The local field $K_{P,C}$ has the discrete valuation subring $\widehat{\mathcal{O}}_{P,C}$. It is mapped onto the local field $k(C)_P$ on C . This local field contains his own discrete valuation subring $\widehat{\mathcal{O}}_P$ and we denote its preimage in $\widehat{\mathcal{O}}_{P,C}$ by $\widehat{\mathcal{O}}'_{P,C}$. We set

$$\Gamma_{P,C} := K_{P,C}^* / \widehat{\mathcal{O}}'^*_{P,C}$$

where $\Gamma_{P,C}$ is a certain abelian group, which is (non-canonically) isomorphic to $\mathbb{Z} \oplus \mathbb{Z}$. However, there is a canonical exact sequence of abelian groups

$$0 \rightarrow \mathbb{Z} \rightarrow \Gamma_{P,C} \rightarrow \mathbb{Z} \rightarrow 0. \tag{11}$$

The map to \mathbb{Z} in the sequence corresponds to the discrete valuation ν_C with respect to C and the subgroup \mathbb{Z} corresponds to the discrete valuation ν_P on C at P . A choice of local coordinates u, t in a neighborhood of P such that locally $C = \{t = 0\}$ provides a splitting of this exact sequence. The group $\Gamma_{P,C}$ will then be isomorphic to the subgroup $\{t^n u^m, n, m \in \mathbb{Z}\}$ in $K_{P,C}^*$.

The group of coordinate transformations $u \mapsto u, t \mapsto tu^k, k \in \mathbb{Z}$ preserves extension (11). Therefore, this determines an embedding

$$\mathbb{Z} \rightarrow \text{Aut}(\Gamma_{P,C}). \tag{12}$$

which in fact is canonical.

We are now going to produce a global analogue of the local construction given above. For that purpose, consider the subgroup $\widehat{\mathcal{O}}'^*$ of \mathbb{A}_X^* , defined as the adelic product of the local groups $\widehat{\mathcal{O}}'^*_{P,C}$ for all flags on an algebraic surface X . Let us consider the quotient

$$\Gamma_X := \mathbb{A}_X^* / \widehat{\mathcal{O}}'^* =: \prod_{(P,C)} \Gamma_{P,C}.$$

We have a natural surjective homomorphism $\mathbb{A}_X^* \rightarrow \Gamma_X$ and all subgroups in \mathbb{A}_X^* such as $\mathbb{A}_{01}^*, \mathbb{A}_{12}^*, \dots, \mathbb{A}_0^*$ have their images $\Gamma_{01}, \Gamma_{12}, \dots, \Gamma_0$ in Γ_X .

Then the structure of Γ_X can be described by an exact sequence

$$0 \rightarrow \prod_C \text{Div}(C) \longrightarrow \Gamma_X \xrightarrow{\pi} \bigoplus_C \prod_{P \in C} \Gamma_{P,C} \rightarrow 0, \tag{13}$$

where, as above, $\text{Div}(C)$ denotes the group of divisors on a curve $C \subset X$ and the restricted product $\prod' \mathbb{Z}$ denotes the set of collections of integers with components whose absolute values are bounded. More precisely,

- (1) The subgroups $\prod_C \text{Div}(C)$ and Γ_{12} in Γ_X coincide.
- (2) The restriction of the homomorphism π to the subgroup $\Gamma_{02} \subset \Gamma_X$ is an isomorphism:

$$\pi|_{\Gamma_{02}} : \Gamma_{02} \xrightarrow{\sim} \bigoplus_C \prod_{P \in C} \Gamma_{P,C}.$$

In other words, we see that there is a canonical splitting $\Gamma_X = \Gamma_{12} \oplus \Gamma_{02}$ of exact sequence (13) which is independent of any possible choice of the coordinates. The groups which we have constructed are abelian. In our two-dimensional case, the crucial point is that they are provided with certain canonical central extensions.

Let us start once more with the local situation, that is we fix a flag $P \in C$ on X . Following [2](see also [30]) we have a canonical central extension of groups

$$1 \rightarrow k(C)_P^* \rightarrow \tilde{K}_{P,C}^* \rightarrow K_{P,C}^* \rightarrow 1. \tag{14}$$

such that the corresponding commutator map in the central extension is a skew form $\langle \cdot, \cdot \rangle : K_{P,C}^* \times K_{P,C}^* \rightarrow k(C)_P^*$ given by the tame symbol (without sign), that is by

$$\langle f, g \rangle = f^{\nu_C(g)} g^{-\nu_C(f)} \pmod{\wp} \in k(C)_P^*, \tag{15}$$

where \wp is the ideal which defines the curve C .

There exists a canonical section of extension (14) over the subgroup $\widehat{\mathcal{O}}_{P,C}^* \subset K_{P,C}^*$. Denote by $\tilde{\mathcal{O}}_{P,C}^*$ the image of $\widehat{\mathcal{O}}_{P,C}^*$ in $\tilde{K}_{P,C}^*$ with respect to this section. If we take the quotient of the extension (14) by the subgroup $\widehat{\mathcal{O}}_P^*$ of the center $k(C)_P^*$ and then by the subgroup $\tilde{\mathcal{O}}_{P,C}^*$ we obtain a new central extension

$$0 \rightarrow \mathbb{Z} \rightarrow \tilde{\Gamma}_{P,C} \rightarrow \Gamma_{P,C} \rightarrow 0. \tag{16}$$

It is well known that $H^2(\mathbb{Z} \oplus \mathbb{Z}, \mathbb{Z}) = \mathbb{Z}$ and the extension (16) is a generator of this group. The commutator in this central extension defines a non-degenerate symplectic form $\langle -, - \rangle$ on $\Gamma_{P,C}$ with values in \mathbb{Z} . Let us fix local parameters u, t at P . Then $\Gamma_{P,C}$ is isomorphic to the group of matrices

$$\begin{pmatrix} 1 & n & c \\ 0 & 1 & p \\ 0 & 0 & 1 \end{pmatrix} \tag{17}$$

with integer entries and $\langle n, p \rangle = np$. We denote this group by $\text{Heis}(3, \mathbb{Z})$. Hence, we arrive at the following class of discrete nilpotent groups.

Definition 2. Let H, H' , and C be abelian groups and let $\langle -, - \rangle : H \times H' \rightarrow C$ be a biadditive pairing. The set $H \times H' \times C$ with the composition law $(n, p, c)(m, q, a) = (n + m, p + q, c + a + \langle n, q \rangle)$, where $n, m \in H, p, q \in H'$ and $c, a \in C$, is called the *discrete Heisenberg group* G .

One then constructs the Heisenberg group G as a group of upper triangular unipotent matrices with H and H' on the second diagonal and C in the right top corner. There is the obvious natural central extension

$$0 \rightarrow C \rightarrow G \rightarrow H \oplus H' \rightarrow 0.$$

In the global case, we have the Heisenberg group $\tilde{\Gamma}_X$ with

$$H' = \Gamma_{02} \cong \bigoplus_C \prod_{P \in C} {}'\mathbb{Z}, \quad \text{by} \quad H' = \Gamma_{02} \cong \bigoplus_C \prod_{P \in C} {}'\mathbb{Z},$$

$$C = I_X := \bigoplus_C \bigoplus_{P \in C} \mathbb{Z}$$

and the pairing $H \times H' \rightarrow \mathbb{C}$ is given by a component-wise multiplication. We thus get a central extension

$$0 \rightarrow I_X \rightarrow \tilde{\Gamma}_X \rightarrow \Gamma_X \rightarrow 0 \tag{18}$$

and for each flag $P \in C$ the restriction of extension (18) to $\Gamma_{P,C}$ coincides with extension (16). So, we obtain in this way a global analogue of the local construction, since we could describe $\tilde{\Gamma}_X$ as an ‘‘adelic’’ product of the local groups $\tilde{\Gamma}_{P,C}$ in an appropriate sense.

There is a natural surjective homomorphism $\varphi : I_X \rightarrow Z^2(X)$, $(n_{P,C}) \mapsto \sum_P (\sum_{C \ni P} n_{P,C})[P]$, where $Z^2(X)$ denotes the group of zero-cycles on X . We set

$$I_{02} := \text{Ker}(\varphi), \quad I_{01} := \bigoplus_C \text{Div}_l(C) \subset \bigoplus_C \text{Div}(C) = I_X.$$

The Heisenberg group $\tilde{\Gamma}_X$ is closely related to the main arithmetic groups attached to the surface X . The quotient $I_X/(I_{01} + I_{02})$ is the second Chow group $CH^2(X)$ of X . Also, there are isomorphisms

$$\Gamma_{01}/(\Gamma_0 + \Gamma_1) \cong (\Gamma_{12} \cap (\Gamma_{01} + \Gamma_{02}))/\Gamma_1 \cong$$

$$\cong (\Gamma_{02} \cap (\Gamma_{01} + \Gamma_{12}))/\Gamma_0 \cong \text{Pic}(X).$$

Moreover, the pairing $\Gamma_{12} \times \Gamma_{02} \rightarrow I_X$ corresponds to the intersection pairing $\text{Pic}(X) \times \text{Pic}(X) \rightarrow CH^2(X)$.

It is remarkable that the groups $K_{P,C}^*$ (and the global adelic groups), which are very far from being locally compact, nevertheless have a non-trivial discrete quotient.

4. Representations of Discrete Heisenberg Groups

We have seen that in the case of dimension two the first non-trivial nilpotent groups have occurred. To define their duals one needs to develop an appropriate representation theory for this class of groups.

For the discrete groups the classical theory of unitary representations on a Hilbert space is not so well developed since these groups are mostly not of type

I. By Thoma's theorem, a discrete group is of type I if and only if it has an abelian subgroup of finite index.

This implies a violation of the main principles of representation theory on Hilbert spaces: non-uniqueness of the decomposition into irreducible components; too bad topology of the unitary dual space; non-existence of characters.... V. S. Varadarajan wrote in 1989: "A systematic developement of von Neumann's ideas led eventually (in the 1950s) to a deep understanding of the decomposition of unitary representations and to results which implied more or less that a reasonable generalization of classical Fourier analysis and representation theory could be expected only for the so-called *type I groups*; *i.e. groups all of whose factor representations are of type I*" [70].

We can also say that the class of unitary representations is too restrictive for the arithmetic purposes.

On the other hand, there exists a theory of smooth representations for p -adic algebraic groups. This theory is also valid for a more general class of totally disconnected locally compact groups. Discrete groups are a simple particular case of this class of groups and the general theory delivers a reasonable class of representations, namely representations on a vector space without any topology. The new viewpoint consists in a systematic consideration of purely algebraic representations in place of unitary representations on Hilbert spaces.

Following [63], we consider now this representation theory for the discrete Heisenberg groups $G = (H, H', C, \langle -, - \rangle)$ where all three groups are finitely generated. We introduce the complex tori $\mathbb{T}_H = \text{Hom}(H, \mathbb{C}^*)$, $\mathbb{T}_{H'} = \text{Hom}(H', \mathbb{C}^*)$ and $\mathbb{T}_C = \text{Hom}(C, \mathbb{C}^*)$, and set $\mathbb{T}_G = \mathbb{T}_H \times \mathbb{T}_{H'} \times \mathbb{T}_C$. The group H is homomorphically mapped to $\mathbb{T}_{H'}$ according to the rule:

$$h \in H \mapsto \{h' \mapsto \chi_C(\langle h, h' \rangle)\}. \quad (19)$$

Denote the kernel of this map by H_χ . If $\chi \in \mathbb{T}_{H'}$ then let $h(\chi)$ be the translate of the character χ by the image of h in $\mathbb{T}_{H'}$. We have $h(\chi_{H'})(p) = \chi_{H'}(p)\chi_C(\langle h, p \rangle)$ for any $p \in H'$. For any $\chi \in \mathbb{T}_G$, $\chi = \chi_H \otimes \chi_{H'} \otimes \chi_C$, let $G_\chi = H_\chi H' C$ be the subset in G . Then G_χ is a normal subgroup in G , which depends only on χ_C and $\chi|_{G_\chi}$ is a character of the group G_χ [65].

Definition 3. Let V_χ be the space of all complex-valued functions f on G which satisfy the following conditions:

1. $f(gh) = \chi(h)f(g)$ for all $h \in G_\chi$.
2. The support $Supp(f)$ is contained in the union of a finite number of left cosets of G_χ .

Left translations define a representation π_χ of the group G on the space V_χ . One can prove that these representations π_χ are irreducible in both possible senses: there are no nontrivial invariant subspaces, and the Schur lemma holds. Furthermore, these representations can be completely classified. Namely, the

representations V_χ and $V_{\chi'}$ are equivalent if and only if three following conditions are satisfied:

1. $\chi_C = \chi'_C$.
2. There exists $h \in H$ such that $\chi'_{H'} = h(\chi_{H'})$.
3. $\chi'_H(h) = \chi_H(h)$ for all $h \in H_\chi$ or equivalently there exists $t \in \mathbb{T}_{H/H_\chi} = \text{Hom}(H/H_\chi, \mathbb{C}^*) \subset \mathbb{T}_H$ such that $\chi'_H = t(\chi_H)$.

Here the torus \mathbb{T}_{H/H_χ} acts on the ambient torus \mathbb{T}_H by translations. The equivalence classes of representations V_χ therefore correspond to orbits of the groups $\mathbb{T}_{H/H_\chi} \times H/H_\chi$ in subsets $\mathbb{T}_H \times \mathbb{T}_{H'} \times \{\chi_C\}$ of the torus \mathbb{T}_G .

The group G is a semidirect product of the groups H and $H'C$ and the main tool for obtaining the results stated above is the Mackey formalism [43] which describes the category of induced representations for semi-direct products of abelian locally compact groups. In the classical theory, this is well-known for unitary representations on Hilbert spaces. In our case, we can use the version of this formalism developed in the theory of representation of p -adic reductive groups [4, 15, 71].

The restriction of functions from the group G to the subgroup H defines a bijection of V_χ with a certain space of functions on H . This space has an explicit basis and we can now define the character of the representation π_χ as the matrix trace of the representation operators $\pi_\chi(g)$ with respect to this basis. It is easy to see that in many cases the corresponding infinite sum of diagonal elements will diverge. The simplest example is the group $\text{Heis}(3, \mathbb{Z})$, see (17).

It is nevertheless possible to define the character if we apply a well-known construction from the theory of loop groups [64][ch. 14.1]. Namely, we have to add some “loop rotations” to the group G . In our context, this means that the group G has to be extended to a semi-direct product $\hat{G} = G \rtimes A$, where $A \subset \text{Hom}(H, H')$ is a non-trivial subgroup.

In the case of the group $\Gamma_{P,C} \cong \text{Heis}(3, \mathbb{Z})$, this extension is suggested by the existence of the group of coordinate transformations on the surface X (see (12)). According to the analogy between algebraic and arithmetic surfaces we discussed above, these coordinate transformations in the two-dimensional local field $\mathbb{F}_q((u))((t))$ indeed correspond to the loop rotations in the field $\mathbb{C}((t))$.

To construct the group $\hat{G} = G \rtimes A$, one needs to extend the automorphisms of the abelian groups $H \oplus H'$ to the automorphisms of the entire Heisenberg group. Note that the group A acts on $H \oplus H'$ by unipotent transformations. When we fix an $r \in H$ and choose $k \in A$, the expression

$$k(m, p, c) = (m, p + k(m), c + 1/2\langle m - r, k(m) \rangle) \quad m \in H, p \in H', c \in \mathbb{C}$$

defines an automorphism of the group G if the following conditions hold:

1. $\langle m, k(m') \rangle = \langle m', k(m) \rangle$ for all $m, m' \in H$
2. $\langle m - r, k(m) \rangle \in 2\mathbb{C}$ for all $m \in H$.

When $k(H_\chi) \subset \text{Ker}(\chi_{H'})$ the representation of G on V_χ can be extended to a representation $\hat{\pi}_\chi$ of the extended group \hat{G} on the same space. Let

$$(\mathbb{T}_\mathbb{C} \times A)_+ := \{\chi \in \mathbb{T}_\mathbb{C}, k \in A : |\chi_\mathbb{C}(\langle n, k(n) \rangle)| < 1 \text{ for all } n \in H/H_\chi, n \neq 0\}$$

be a relation in $\mathbb{T}_\mathbb{C} \times A$, let $A(\chi)$ be the projection of the set $(\mathbb{T}_\mathbb{C} \times A)_+ \cap (\{\chi\} \times A)$ to A and let $\hat{G}(\chi) = G \times A(\chi) \subset \hat{G}$.

We can now solve the existence problem for the characters. The trace $\text{Tr } \hat{\pi}_\chi(g)$ exists for all $g \in \hat{G}(\chi)$ and we have

$$\text{Tr } \hat{\pi}_\chi(g) = \chi_H(m)\chi_{H'}(p)\chi_\mathbb{C}(c) \cdot \sum_{n \in H/H_\chi} \chi_{H'}(k(n))\chi_\mathbb{C}(\langle n, p \rangle + 1/2\langle n - r, k(n) \rangle).$$

for $g = (m, p, c, k)$, $k \in A(\chi)$, $m \in H_\chi$. The trace is zero if m does not belong to H_χ .

The trace is well-defined, but does not determine a function on the set of equivalence classes of representations. To overcome this difficulty, we have to consider representations of the extended group \hat{G} .

Let $\mathbb{T}_A = \text{Hom}(A, \mathbb{C}^*)$ and $\mathbb{T}_{\hat{G}} = \mathbb{T}_G \times \mathbb{T}_A$. If $\hat{\chi} = (\chi, \chi_A) \in \mathbb{T}_{\hat{G}}$, then we set

$$\hat{\pi}_{\hat{\chi}} = \hat{\pi}_\chi \otimes \chi_A.$$

We therefore have $\text{Tr } \hat{\pi}_{\hat{\chi}} = \text{Tr } \hat{\pi}_\chi \cdot \chi_A$. For a given $g \in \hat{G}(\chi)$, the trace $\text{Tr } \hat{\pi}_{\hat{\chi}}(g)$ can be considered as a function on the domain $T' = \mathbb{T}_H \times \mathbb{T}_{H'} \times \mathbb{T}_\mathbb{C}(k) \times \mathbb{T}_A$ in the torus $\mathbb{T}_{\hat{G}}$, where $\mathbb{T}_\mathbb{C}(k)$ is the projection of the set $(\mathbb{T}_\mathbb{C} \times A)_+ \cap (\mathbb{T}_\mathbb{C} \times \{k\})$ to the torus $\mathbb{T}_\mathbb{C}$.

Let us define an action of the group $\mathbb{T}_{H/H_\chi} \times H$ on the set $\mathbb{T}_H \times \mathbb{T}_{H'} \times \{\chi_\mathbb{C}\} \times \mathbb{T}_A \subset T'$ by the formula

$$(t, h)(\chi_H, \chi_{H'}, \chi_\mathbb{C}, \chi_A) = (t(\chi_H), h(\chi_{H'}), \chi_\mathbb{C}, \chi'_A), \quad (20)$$

where

$$\chi'_A(k) = \chi_A(k)\chi_{H'}(k(h))\chi_\mathbb{C}(1/2\langle h - r, k(h) \rangle), \quad k \in A.$$

We define the space $\mathcal{M}_G(k)$, $k \in A$ as the quotient of the domain T' by this action. The quotient-space is a complex-analytic manifold, in fact a fibration over a domain in $\mathbb{T}_\mathbb{C}$. For a given $g = (m, p, c, k) \in \hat{G}(\chi)$ the trace $\text{Tr } \hat{\pi}_{\hat{\chi}}(g)$ is invariant, under a simple additional condition, under the action (20) and defines a holomorphic function $F_g = F_g(\hat{\chi})$ on $\mathcal{M}_G(k)$. We now obtain the main property that the characters must enjoy:

Let $\hat{\chi}, \hat{\chi}' \in \mathbb{T}_{\hat{G}}$. The representations $\hat{\pi}_{\hat{\chi}}$ and $\hat{\pi}_{\hat{\chi}'}$ are equivalent if and only if $\hat{G}(\chi) = \hat{G}(\chi')$ and $F_g(\hat{\chi}) = F_g(\hat{\chi}')$ for all $g \in \hat{G}(\chi)$.

Thus we see that the space $\mathcal{M}_G(k)$ is actually a moduli space for a certain class of representations of \hat{G} .

Let us consider the simplest example, that of the group $\text{Heis}(3, \mathbb{Z})$. Let $A = \mathbb{Z} = \text{Hom}(H, H')$, $r = 1$, $\hat{G} = G \rtimes \mathbb{Z}$ and $\chi_C(c) = \lambda^c$, $\chi_C \in \mathbb{T}_C(k > 0)$ where $\mathbb{T}_C(k > 0) = \{0 < |\lambda| < 1\}$. Then $\mathbb{T}_{H'}/\text{Im}H =: E_\lambda$ is an elliptic curve, where $z \in \mathbb{T}_{H'} = \mathbb{C}^*$, $\text{Im}H = \{\lambda^{\mathbb{Z}}\}$. We have a degree map

$$\text{Pic}(E_\lambda) = H^1(E_\lambda, \mathcal{O}^*) = H^1(H, \mathcal{O}^*(\mathbb{T}_{H'})) \rightarrow \text{Hom}(H, H') = A,$$

and

$$\text{Pic}(E_\lambda) = \{\varphi(n, z) = a^{-n} z^{-kn} \lambda^{-1/2kn(n-1)} : a \in \mathbb{C}^*, k \in A = \mathbb{Z}\}.$$

Let L be the line bundle which corresponds to a 1-cocycle φ . Then

$$H^0(E_\lambda, L) = \{f(z), z \in \mathbb{T}_{H'} : f(\lambda^n z) = \varphi(n, z)f(z)\}.$$

The theta-series

$$\vartheta_{p,k,a}(z, \lambda) := z^p \sum_{n \in \mathbb{Z}} a^n z^{kn} \lambda^{np+1/2kn(n-1)}$$

(which are the Poincaré series with respect to φ) converge for all $z \in \mathbb{C}^*$, $0 < |\lambda| < 1$, $k > 0$, and form a basis of the space $H^0(E_\lambda, L)$ for $0 \leq p < k$. Finally,

$$\text{Tr } \hat{\pi}_{\hat{\chi}}(0, p, c, k) = \lambda^c t^k \vartheta_{p,k,1}(z, \lambda), \quad (z, \lambda) \in \mathcal{A}_G(k), t \in \mathbb{T}_A. \quad (21)$$

In this case, the theta-series lifted to $\overline{\mathcal{A}}_G(k) = \mathbb{C} \times \{\text{upper halfplane}\}$ are Jacobi modular forms (up to some powers of λ and z) with respect to the standard action of a finite index subgroup of the group $(\mathbb{Z} \oplus \mathbb{Z}) \rtimes \text{SL}(2, \mathbb{Z})$. This last statement is completely parallel to a well-known property of characters for representations of affine Kac-Moody algebras [31, 64].

In the more general situation in which H and H' are torsion-free groups and $C = \mathbb{Z}$, $|\chi_C(c)| \neq 1$ for $c \neq 0$, the map $k : H \rightarrow H'$ is a monomorphism with finite cokernel, $A = \mathbb{Z}k$ and the form $\langle -, k(-) \rangle$ is positive-definite, we have two dual abelian varieties $E = \mathbb{T}_{H'}/\text{Im}H$ and $E' = \mathbb{T}_H/\text{Im}H'$ with the Poincaré bundle \mathcal{P} over $E \times E'$. The morphism k defines an isogeny $\varphi_k : E \rightarrow E'$ and the sheaf L is defined as $(\text{Id} \times \varphi_k)^* \mathcal{P}$. By Mumford's theory [44], there exists a finite Heisenberg group $\widetilde{\text{Ker}}(\varphi_k)$, which is a central extension of the group $\text{Ker}(\varphi_k)$. Then for all $g = (m, p, c, k) \in \hat{G}(\chi)$ the values of the characters $\text{Tr } \hat{\pi}_{\hat{\chi}}(g) \chi_C^{-1}(c) \chi_A^{-1}(k)$ are theta-functions for the bundle L .

If $\hat{\chi} = 1 \otimes \chi_{H'} \otimes \chi_C \otimes 1$, then the functions $\text{Tr } \hat{\pi}_{\hat{\chi}}(0, p, 0, k)$ for $p \in H' \text{ mod } k(H)$ form a basis of the space $H^0(E, L)$. This basis is a standard Mumford basis for the action of the Heisenberg group $\widetilde{\text{Ker}}(\varphi_k) = (H'/H, \mathbb{T}_{H'/H}, \mathbb{C}^*)$ on the space $H^0(E, L)$.

In addition, certain orthogonality relations are satisfied by the characters [63].

The boundary of the domain $\mathbb{T}_C(k)$ can contain those characters $\chi_0 \in \mathbb{T}_C$ for which H_{χ_0} has a finite index in H . These characters correspond to the

roots of unity in \mathbb{C}^* , so that the representations π_{χ_0} are finite-dimensional. Let $V = H \otimes \mathbb{R}$ and Q be the extension of the pairing $\langle n, k(n) \rangle$, $n \in H$ to the space V . Also, let $\chi_{\mathbb{C}}(c) = \lambda^c$ and let us choose a boundary point χ_0 . The classical limit formulas for theta-functions imply the following behavior of the trace near the χ_0 (we assume that $\chi_H = 1$ and $\chi'_H = 1$):

$$\mathrm{Tr} \hat{\pi}_{\hat{\chi}}(g) \sim \mathrm{Tr} \hat{\pi}_{\hat{\chi}_0}(g) \cdot [H : H_{\chi_0}]^{-1} (\mathrm{Det}_V Q)^{-1} \left(\frac{\sqrt{\pi}}{2} \right)^{\mathrm{rk} H} \log |\lambda|^{-\frac{1}{2} \mathrm{rk} H} \text{ when } \chi_{\mathbb{C}} \rightarrow \chi_0. \quad (22)$$

The trace of the representation $\hat{\pi}_{\hat{\chi}_0}$ can be computed in terms of a Gauss sum.

Thus, we see that, in our situation, the change in the class of representations will cause the moduli spaces of induced representations to be complex-analytic manifolds. Characters do exist and are the modular forms. It seems that this more general holomorphic dual space is more adequate for this class of groups than the standard unitary dual which goes back to the Pontrjagin duality for abelian groups.

5. Problems and Perspectives

We collect here several problems related to the issues we have discussed in the talk.

1. Harmonic analysis for local fields and adelic groups of arbitrary dimension n .

The basic category for this study has to be the category C_n [49] and its version that includes fields of the archimedean type [51]. When one tries to extend the measure theory and harmonic analysis to n -dimensional local fields and adelic groups for $n > 2$ the following problem arises. The selection rules become too severe to go further in a straightforward way. This obstacle appears already for n -dimensional local fields with $n = 3$. We can define the spaces analogous to $\mathcal{D}(V)$ or $\mathcal{D}'(V)$ only under some strong restrictions on the groups V (= objects in C_n). Note that spaces such as $\mathcal{E}(V)$ can be easily defined for any n and arbitrary group V .

2. The Tate-Iwasawa method for two-dimensional schemes.

J. Tate [68] and independently K. Iwasawa [29] reformulated the classical problem of analytic continuation for zeta- and L- functions for the fields of algebraic numbers and the fields of algebraic functions in one variable over a finite field. They introduced a new type of L -functions:

$$L(s, \chi, f) = \int_{\mathbb{A}^*} f(g) \chi(g) |g|^s d^*g$$

where d^*g is a Haar measure on \mathbb{A}^* , the function f belongs to the Bruhat-Schwartz space of functions on \mathbb{A}_X and χ is an abelian character of the group \mathbb{A}^* associated to a character

$$\chi : \text{Gal}(K^{\text{ab}}/K) \rightarrow \mathbb{C}^*$$

of the Galois group by the reciprocity map $\mathbb{A}^* \rightarrow \text{Gal}(K^{\text{ab}}/K)$. They also proved the analytic continuation of $L(s, \chi, f)$ to the entire s -plane and the functional equation

$$L(s, \chi, f) = L(1 - s, \chi^{-1}, F(f))$$

by means of the Fourier transform F and the Poisson formula for functions on \mathbb{A}_X (8), (9).

For a special choice of f and $\chi = 1$ we obtain the zeta-function

$$\zeta_X(s) = \prod_{x \in X} (1 - (\#k(x))^{-s})^{-1},$$

of any scheme X of dimension one (to which we have to add, if necessary, the archimedean factors). Here x runs through the closed points of X . The product converges for $\text{Re}(s) > \dim X$.

There exists a general Hasse-Weil conjecture [23, 73] which asserts that these zeta- (and more general L -) functions can be meromorphically extended to the entire s -plane and satisfy the functional equation (for regular proper schemes X of dimension n) of the type $\zeta_X(n - s) = \{\text{elementary factors}\} \zeta_X(s)$.

This conjecture has been completely proved for algebraic varieties defined over a finite field \mathbb{F}_q . For this goal the powerful machinery of the étale cohomology has been developed by A. Grothendieck. For schemes over $\text{Spec}(\mathbb{Z})$, the general results are known only in dimension one, thanks to the Hecke's theorem. Later this was included into the Tate-Iwasawa approach. At the same time, this approach works for algebraic curves defined over \mathbb{F}_q . For the higher dimensions over $\text{Spec}(\mathbb{Z})$, there are only scattered results; however these include the proof of the Hasse-Weil conjecture for elliptic curves over \mathbb{Q} [75, 8].

For a long time the author has advocated the following

Problem. *Extend Tate-Iwasawa's analytic method to higher dimensions (see in particular [58]).*

The higher adèles were introduced precisely for this purpose. We hope that harmonic analysis and representation theory of adelic groups on two-dimensional schemes may help to solve this problem.

3. Behavior of zeta- and L-functions in the critical strip.

The critical strip for the ordinary Riemann's zeta-function is $0 \leq \Re(s) \leq 1$ and this zeta-function (with an archimedean factor) has there exactly two

poles, both of first order. For the two-dimensional case, the critical strip is wider, namely $0 \leq \Re(s) \leq 2$. Take as X a model over $\text{Spec}(\mathbb{Z})$ of an elliptic curve E defined over \mathbb{Q} . The Birch and Swinnerton-Dyer conjecture [5, 69] states that

$$\zeta_X(s) \underset{s \rightarrow 1}{\sim} \frac{\#E(\mathbb{Q})_{\text{tor}}^2}{c \Omega \text{Det}_{E(\mathbb{Q})}\langle -, - \rangle \#\text{III}} (s - 1)^{-r-2}, \tag{23}$$

where $E(\mathbb{Q})$ is the finitely generated Mordell-Weil group of rational points on E , r is its rank, $\langle -, - \rangle$ is the height pairing, Ω is the real period of the curve, III is the Shafarevich-Tate group and c is a product of certain local invariants.

Many years ago several people, including the author, have independently observed that this limit behavior is very similar to the limit behavior of a theta-function attached to a lattice. Namely, let V/\mathbb{R} be a finite dimensional euclidean vector space of dimension n . Denote by $\langle -, - \rangle$ the scalar product on V . Let Γ be a finitely generated abelian group such that $\Gamma \otimes \mathbb{R} = V$ and let $\Gamma' = \Gamma/\Gamma_{\text{tor}}$ be the corresponding lattice (= a discrete co-compact subgroup) in V . Then the theta-function $\theta_\Gamma(t)$ is defined as

$$\theta_\Gamma(t) := \sum_{\gamma \in \Gamma} e^{-\pi t \langle \gamma, \gamma \rangle} = \#\Gamma_{\text{tor}} \cdot \theta_{\Gamma'}(t)$$

and satisfies the functional equation

$$\theta_{\Gamma'}(t) = t^{-\frac{n}{2}} \text{Vol}(\Gamma')^{-1} \theta_{\Gamma'^\perp}(t^{-1}),$$

where $\Gamma'^\perp \subset V$ is the dual lattice and the volume of the fundamental domain for Γ' is $\text{Vol}(\Gamma') = \det(\langle e_i, e_j \rangle)$ with $\{e_i\}$ a basis of the free \mathbb{Z} -module Γ' .

In particular, we get

$$\theta_\Gamma(t) \underset{t \rightarrow 0}{\sim} \#\Gamma_{\text{tor}} \text{Vol}(\Gamma)^{-\frac{1}{2}} t^{-\frac{n}{2}}.$$

If we apply this asymptotic formula to the group $\Gamma \oplus \Gamma$ then we get

$$\theta_{\Gamma \oplus \Gamma}(t) \underset{t \rightarrow 0}{\sim} \frac{\#\Gamma_{\text{tor}}^2}{\text{Det}_\Gamma \langle -, - \rangle} t^{-r-2}, \tag{24}$$

which looks rather similar to the conjecture (23) if we take as Γ the group $E(\mathbb{Q}) \oplus \mathbb{Z} \oplus \mathbb{Z}$. D. Zagier has devoted to this relation a note [77] with many interesting remarks and observations. In particular, he discussed the question of interpreting such factors as Ω and $\#\text{III}$ which are not visible in the theta-formula (24).

In order to clarify the situation, let us look at the corresponding behavior of the zeta-function of an algebraic surface X defined over \mathbb{F}_q . The analogy between geometric surfaces over \mathbb{F}_q and arithmetic surfaces such as this model X of E suggests that this may be a useful move.

The value of the zeta function at $s = 1$ is given by the conjecture of Artin and Tate [69, 45]. We assume that X is a smooth proper irreducible surface.

Denote by $\rho = \text{rk NS}(X)$ the rank of the Neron-Severi-group of X and let $\{D_i\}$ with $D_i \in \text{NS}(X)$ $i = 1, \dots, \rho$ be a basis of $\in \text{NS}(X) \otimes \mathbb{Q}$. Denote by $D_i \cdot D_j$ their intersection index. Let $\text{Br}(X) = H^2(X_{\text{ét}}, \mathcal{O}_X^*)$ be the Brauer group of X . Then the group $\text{Br}(X)$ is conjectured to be finite and the following relation holds:

$$\zeta_X(s) \underset{s \rightarrow 1}{\sim} (-1)^{\rho-1} q^{\chi(\mathcal{O}_X)} \frac{\#\text{Pic}(X)_{\text{tor}}^2}{\#H^0(X, \mathcal{O}_X^*)^2 \#\text{Br}(X) \det((D_i \cdot D_j))} (1 - q^{1-s})^{-\rho}.$$

Within the framework of the analogy between geometry and arithmetic [61], the group $\text{NS}(X)$ corresponds to the group $E(\mathbb{Q}) \oplus \mathbb{Z} \oplus \mathbb{Z}$, the intersection index corresponds to the height pairing, the period Ω corresponds to $q^{\chi(\mathcal{O}_X)}$ and the Brauer group to the Shafarevich-Tate group III.

Since $(1 - q^{1-s})^{-\rho} \underset{s \rightarrow 1}{\sim} (s - 1)^{-\rho} (\log q)^{-\rho}$, we again guess that certain theta-functions related to the lattice $\text{NS}(X)$ may have this kind of the limit behavior. An immediate objection to this suggestion is that the intersection pairing is not positive-definite. This can be resolved if we consider the Siegel theta-functions attached to indefinite quadratic forms.

The case of surfaces makes it clear that this question is highly non-trivial. Zeta-functions of algebraic varieties over \mathbb{F}_q are very simple analytic functions. Indeed, according to Grothendieck's theory, they are equal to $F(q^{-s})$ where $F(t)$ is a rational function of a variable t . The theta-functions involved are certainly transcendental functions, which cannot be simplified in this way by substitution. Thus the problem we arrive at is to understand how theta-functions can appear in this setting in a natural way, and how to relate them to zeta-functions. We conjecture that the theta-functions which occur into the traces of representations of the adelic groups constructed above could be such theta-functions. Their behavior in the limit (22) has the structure we have just described.

It is worth mention another problem, the so called S -duality conjecture, which is quite close to what have been discussed here. The problem came from the quantum field theory [72] but has purely algebraic formulation for an algebraic surface X over a finite field \mathbb{F}_q (see a discussion in [32]). Let $M_{r,n}$ be a moduli space of semi-stable vector bundles E on X with given rank r , trivial determinant and the second Chern class $c_2(E) = n$. Then the formal series

$$\sum_n \#M_{r,n}(\mathbb{F}_q) q^{-ns}$$

is expected to have under mild conditions on X a modular behavior with respect to a congruence subgroup of the group $\text{SL}(2, \mathbb{Z})$. It is remarkable that the transcendental functions appear once more in relation to a surface defined over a finite field.

4. Representations of discrete nilpotent groups.

i) The representations π_χ and $\hat{\pi}_{\hat{\chi}}$ of the discrete Heisenberg groups are particular examples of the irreducible representations of these groups. Thus,

the problem of classification of all irreducible representations arises. Of course, one needs to impose certain conditions in order to get a reasonable answer. In the theory of unitary representations for discrete nilpotent finitely generated groups G on a Hilbert space such a condition was found in [9]. One says that a representation π of G on a space V has the finite multiplicity property if there exists a subgroup $H \subset G$ which preserves a line l in V and such that the character of H defined by the action of H on l occurs in $\pi|_H$ as a discrete direct summand with finite multiplicity. Then the class of irreducible representations with this property coincides with the class of irreducible monomial (= induced by an one-dimensional character) representations of G .

It is highly desirable to define in our algebraic situation a class of “basic” induced representations which will play the role that the Verma modules or representations with highest weight do for the representations of reductive Lie groups (or algebraic groups). This is closely related to a problem of classification of (say, left) maximal ideals in the group ring of G .

ii) The moduli spaces $\mathcal{M}_G(k)$ defined above are orbit spaces for group actions. This construction looks very similar to the Kirillov’s orbit method for connected real (or complex) nilpotent Lie groups G (or nilpotent algebraic groups over \mathbb{Q}_p) [39] where the unitary dual is the space \mathfrak{g}^*/G of co-adjoint orbits in the dual \mathfrak{g}^* of the Lie algebra \mathfrak{g} of G . Attempts to extend Kirillov’s method to finitely generated nilpotent groups were made in [24, 36] (see also [6]). It seems that there is a general functorial definition of spaces such as $\mathcal{M}_G(k)$ for arbitrary nilpotent discrete groups which will replace the spaces \mathfrak{g}^*/G in this situation, just as the torus $\mathbb{T}_{\hat{G}}$ may be an analogue of the space \mathfrak{g}^* . The Kirillov’s character formula may also exist in this situation.

iii) When one tries to apply the representation theory developed in section 5 to the nilpotent groups which arise from the algebraic surfaces X (section 4), one immediately observes that:

- 1) the groups like $\tilde{\Gamma}_X$ are not finitely generated;
- 2) the groups like $(\text{Pic}(X), \text{Pic}(X), \text{CH}(X))$ are equipped with the indefinite form $\langle -, - \rangle$.

Certainly, the representation theory cannot be automatically extended to the case of infinitely generated groups. In our case, the “big” group $\tilde{\Gamma}_X$ is the adelic product of simplest Heisenberg groups $\tilde{\Gamma}_{P,C}$ and consequently is an inductive limit of finite products of these local groups. We can easily extend all the representation-theoretic constructions to the case of $\tilde{\Gamma}_X$ if we apply the technique from the theory of adelic products of reductive algebraic groups over 1-dimensional local fields. The role of the compact subgroups is now played by co-finite products of the local Heisenberg groups.

The problem 2) can also be solved. A solution is based on using the Siegel theta-functions for indefinite quadratic forms that are well suited for this situation.

iv) An important problem is to develop an analysis on discrete Heisenberg groups G , in particular, to define appropriate function spaces on G , the analogue of the map \mathcal{L} (see (8) in section 3) and to obtain a Plancherel-type theorem which relates the function spaces on G and spaces of holomorphic (or meromorphic) functions on $\mathcal{M}_G(k)$.

v) There exists a general question of the decomposition into the irreducible components of representations of discrete nilpotent groups. It is known that the regular representation (on the L^2 -space on G) of a discrete group G may have very different decompositions into irreducible components (see a first example of this kind in [43]). On the other hand, in our situation there is a rather concrete problem: how does one decompose the natural fundamental representation of the group $\tilde{\Gamma}_X$ (and locally of the groups $\tilde{\Gamma}_{P,C}$) on the spaces $\mathcal{D}_{\mathbb{A}_{12}}(\mathbb{A}_X)^{\mathcal{O}^*}$ or $\mathcal{D}'_{\mathbb{A}_{12}}(\mathbb{A}_X)^{\mathcal{O}^*}$ (respectively in $\mathcal{D}_{\mathcal{O}_{P,C}}(K_{P,C})^{\mathcal{O}_{P,C}^*}$ or $\mathcal{D}'_{\mathcal{O}_{P,C}}(K_{P,C})^{\mathcal{O}_{P,C}^*}$) on a surface X ?

vi) Our theory deals with the discrete “part” of the adelic group $\mathbb{A}_X^* = \text{GL}(1, \mathbb{A}_X)$. D. Gaitsgory and D. Kazhdan have extended the traditional theory of representations for reductive p -adic groups (parabolic induction, Jacquet functor, cuspidal representations) to the case of groups $\text{GL}(n, K)$ where K is a two-dimensional local field (and of more general reductive groups)[18, 19, 20]. An important and certainly very hard problem is to merge these two theories, at least for the group $\text{GL}(2, \mathbb{A}_X)$.

vii) For the schemes of dimension two, we constructed discrete Heisenberg groups, which are nilpotent groups of class 2. It is possible to associate certain discrete adelic groups to schemes of arbitrary dimension n and that are the nilpotent groups of class n .

In this text, we mainly gave a review of certain recent advances in the higher adelic theory. During the last thirty years, this theory was developed in many different directions. We finish with a short list of these developments⁸:

- residues and symbols [53, 54, 17, 76, 11, 12, 13, 37, 38, 47, 67, 52]
- class field theory for higher dimensions: the author, K. Kato and his school, S. V. Vostokov and his school, see surveys [17, 16, 28, 66]
- adelic resolutions for sheaves, intersection theory, Chern classes, Lefschetz formula for coherent sheaves [55, 76, 26, 27, 21, 22]
- algebraic groups over local fields, buildings, Hecke algebras [56, 60, 34, 18, 19, 20, 7]
- restricted adelic complexes and the Krichever correspondence [59, 46, 48, 40, 41]
- relations with non-commutative algebra [57, 78].

⁸This list of references does not pretend to be complete.

References

- [1] *Algebraic Number Theory*, Ed. J. W. S. Cassels and A. Fröhlich, Academic Press, London-New York, 1967.
- [2] E. Arbarello, V. G. Kac, C. De Concini, *The Infinite Wedge Representation and the Reciprocity Law for Algebraic Curves*, *Comm. Math. Phys.*, **117** (1988), 1–36.
- [3] A. A. Beilinson, *Residues and Adeles*, *Func. Anal. Appl.*, **14**, no. 1 (1980), 34–35.
- [4] J. N. Bernstein, A. V. Zelevinsky, *Representations of the group $GL(n, F)$, where F is a local non-archimedean field*, *Russian Math. Surveys*, **31**(1976), 1–68.
- [5] B. Birch, H. P. F. Swinnerton-Dyer, *Notes on elliptic curves I, II*, *Journ. Reine u. Angew. Math.* **212** (1963), 7–25; **218** (1965), 79–108.
- [6] Mitya Boyarchenko, Maria Sabitova, *The orbit method for profinite groups and p -adic analogue of Brown's theorem*, e-print arXiv: mathRT/0608126.
- [7] A. Braverman, D. Kazhdan, *Some examples of Hecke algebras for two-dimensional local fields*, *Nagoya Math. J.*, **184** (2006), 57–84.
- [8] C. Breuil, B. Conrad, F. Diamond, R. Taylor, *On the modularity of elliptic curves over \mathbb{Q} : wild 3-adic exercises*, *J. Amer. Math. Soc.*, **14** (2001), no. 4, 843–939.
- [9] I. D. Brown, *Representation of finitely generated nilpotent groups*, *Pacif. J. Math.*, **45** (1973), 13–25.
- [10] F. Bruhat, *Distributions sur un groupe localement compact et applications à l'étude des représentations des groupes φ -adiques*, *Bull. Soc. Math. France*, **89** (1961), 43–75.
- [11] J.-L. Brylinski, D. A. McLaughlin, *Multidimensional reciprocity laws*, *J. Reine Angew. Math.* **481** (1996), 125–147.
- [12] J.-L. Brylinski, D. A. McLaughlin, *Characteristic classes and multidimensional reciprocity laws*, *Math. Res. Lett.* **3** (1996), No.1, 19–30.
- [13] J.-L. Brylinski, D. A. McLaughlin, *The geometry of two-dimensional symbols*, *K-Theory* **10** (1996), No.3, 215–237.
- [14] M. Burger, *Analyse Harmonique sur les groupes de Heisenberg généralisés*, *Monatsch. für Math.*, **98** (1984), 29–40.
- [15] P. Cartier, *Representations of φ -adic groups: a survey*, *Automorphic forms, representations and L -functions*, *Proc. Symposia in Pure Math.*, **33** (1979), Part 1, Amer. Math. Soc., Providence, RI, 1979, 111–155.
- [16] I. B. Fesenko, S. V. Vostokov, *Local fields and their extensions. A constructive approach*, Amer. Math. Soc., Providence, RI, 1993, 283pp.
- [17] T. Fimmel, A. N. Parshin, *An introduction to the higher adelic theory*, preprint 1999.
- [18] D. Gaitsgory, D. Kazhdan, *Representations of algebraic groups over a 2-dimensional local field*, *Geom. and Funct. Analysis*, **14** (2004), n 3, 535–574; arXiv math. RT/0302.174.
- [19] D. Gaitsgory, D. Kazhdan, *Algebraic groups over a 2-dimensional local field: irreducibility of certain induced representations*, *J. Differ. Gom.* **70** (2005), No. 1, 113–127 (2005); arXiv: math/0409543.

- [20] D. Gaiitsgory, D. Kazhdan, *Algebraic groups over a 2-dimensional local field: some further constructions*, Bernstein, Joseph (ed.) et al., Studies in Lie theory. Dedicated to A. Joseph on his sixtieth birthday. Progress in Mathematics **243**, Basel: Birkhauser, 2006, 97–130; arXiv: math/0406282.
- [21] S. O. Gorchinskiy, A. N. Parshin, *Adelic Lefschetz formula for the action of a one-dimensional torus*, Uraltseva, N.N.(ed.), Proceedings of the St. Petersburg Mathematical Society. Vol. XI. Translations. Series 2. Amer. Math. Soc. **218** (2006), 31–48; e-print arXiv: math/0408058.
- [22] S. O. Gorchinskiy, *An adelic resolution for homology sheaves*, Izvestiya: Mathematics **72** (2008), No. 6, 1187–1252; e-print arXiv: math/0705.2597.
- [23] H. Hasse *Zetafunktionen und L-Funktionen zu einem arithmetischen Funktionenkörper vom Fermatschen Typus*, Abh. S. Akad. Wiss. Berlin Math. Kl. (1954), 5–70 (= Helmut Hasse, *Mathematische Abhandlungen*, Band **2**, Berlin-New York: Walter de Gruyter, 1975, S. 450).
- [24] R. E. Howe, *On representations of discrete, finitely generated, torsion-free, nilpotent groups* Pacif. J. Math. **73** (1977), 281–305.
- [25] A. Huber, *On the Parshin-Beilinson Adeles for Schemes*, Abh. Math. Sem. Univ. Hamburg **61** (1991), 249–273.
- [26] R. Hübl, A. Yekutieli, *Adeles and differential forms*, J. Reine u. Angew. Math. **471** (1996), 1–22.
- [27] R. Hübl, A. Yekutieli, *Adelic Chern forms and applications*, Am. J. Math. **121** (1999), No.4, 797–839.
- [28] *Invitation to higher local fields (Münster, 1999)*, (ed. I. Fesenko, M. Kurihara), Geom. Topol. Monogr., **3**, Geom. Topol. Publ., Coventry, 2000, 304pp.
- [29] K. Iwasawa, *A note on functions*, Proc. Intern. Congres Math. (1950), Cambridge, Mass., 1950, vol.2, 322.
- [30] V. G. Kac, D. H. Peterson, *Spin and wedge representations of infinite-dimensional Lie algebras and groups*, Proc. Nat. Acad. Sci. USA **78** (1981), 3308–3312.
- [31] V. G. Kac, D. H. Peterson, *Infinite-dimensional Lie algebras, Theta-functions and Modular Forms*, Advances in Math. **53**(1984), 125–264.
- [32] M. M. Kapranov, *The elliptic curve in the S-duality theory and Eisenstein series for Kac-Moody groups*, e-print arXiv:mathAG/0001005.
- [33] M. M. Kapranov, *Semiinfinite symmetric powers*, e-print arXiv: math.QA/0107089.
- [34] M. M. Kapranov, *Double affine Hecke algebras and 2-dimensional local fields*, J. Amer. Math. Soc., **14** (2001), n 1, 239–262; e-print arXiv math.AG/9812021.
- [35] D. A. Kazhdan, *Fourier transform over local fields*, Milan J. Math. **74** (2006), 213–225.
- [36] K. P. Kokhas', *Finite factor representations of 2-step nilpotent groups and orbit theory*, Zap. Nauchn. Semin. POMI **307**, 120–140, 282 (2004); translation in J. Math. Sci., New York **131** (2005), No. 2, 5508–5519.
- [37] A. G. Khovanskii, *An analog of determinant related to Parshin-Kato theory and integer polytopes*, Funct. Anal. Appl. **40** (2006), No. 2, 126–133.

- [38] A. G. Khovanskii, *Logarithmic functional and reciprocity laws*, Toric topology: international conference, May 2008, Contemporary Mathematics, Vol. **46** (2008).
- [39] A. A. Kirillov, *Lectures on the orbit method*, Graduate Studies in Mathematics, vol. **64**, Providence, RI: Amer. Math.Soc. 2004, xx, 408 p.
- [40] H. Kurke, D. V. Osipov, A. B. Zheglov, *Formal punctured ribbons and two-dimensional local fields*, J. Reine u. Angew. Math. **629** (2009), 133–170; e-print arXiv: math/07080985.
- [41] H. Kurke, D. V. Osipov, A. B. Zheglov, *Formal groups arising from formal punctured ribbons*, Intern. J. Math. **21** (2010), 755–797. to appear; e-print arXiv:0901.1607.
- [42] S. Lefschetz, *Algebraic topology*, AMS Colloquium Publications **27**, Amer. Math. Soc. New York, 1942.
- [43] G. Mackey, *On induced representations of groups*, Amer. J. Math. **73** (1951), 576–592.
- [44] D. Mumford, *On equations defining abelian varieties I*, Inv. Math., **1** (1966), 287–354.
- [45] J. S. Milne, *On a conjecture of Artin and Tate*, Ann. of Math. **102**(1975), 517–533.
- [46] D. V. Osipov, *The Krichever correspondence for algebraic varieties*, Izvestiya. Mathematics **65**(2001), no. 5, 941–975; arXiv: math/0003188.
- [47] D. V. Osipov, *Central extensions and reciprocity laws on algebraic surfaces*, Sbornik: Mathematics **196**, N 10 (2005), 1503–1527; see also arXiv: math.NT/0501155.
- [48] D. V. Osipov, *n-dimensional local fields and adeles on n-dimensional schemes*, Surveys in Contemporary Mathematics, Edited by N. Young, Y. Choi; London Mathematical Society Lecture Note Series, vol. **347** (2007), pp. 131–164, Cambridge University Press; e-print math.AG/0508205.
- [49] D. V. Osipov, *Adeles on n-dimensional schemes and categories C_n* , Intern. J. Math., **18** (2007), no. 3, 269–279; e-print arXiv: math.AG/0509189.
- [50] D. V. Osipov, A. N. Parshin, *Harmonic analysis on local fields and adelic spaces I*, Izvestiya: Mathematics, **72** (2008), 915–976; e-print arXiv: math/0707.1766.
- [51] D. V. Osipov, A. N. Parshin, *Harmonic analysis on local fields and adelic spaces II*, Izvestiya: Mathematics (to appear); e-print arXiv: math/0912.1577.
- [52] Denis Osipov, Xinwen Zhu, *Categorical proof of Parshin reciprocity laws on algebraic surface*, e-print arXiv: math.AG/1002.4848.
- [53] A. N. Parshin, *Class fields and algebraic K-theory*, Uspekhi Mat. Nauk. **30** (1975), 253–254 (in russian).
- [54] A. N. Parshin, *On the arithmetic of two-dimensional schemes I. Repartitions and residues*, Math. USSR Izvestiya **10** (1976), No.4, 695–729.
- [55] A. N. Parshin, *Chern classes, adeles and L-functions*, J. Reine u. Angew. Math., **341** (1983), 174–192.
- [56] A. N. Parshin, *Vector Bundles and Arithmetical Groups I*, Proc. Steklov Inst. Math. **208** (1995), 212–233; e-print arXiv: alg-geom/9605001.

- [57] A. N. Parshin, *On a ring of formal pseudodifferential operators*, Proc. Steklov Inst. Math. **224** (1999), 266–280; e-print arXiv: math/9911098.
- [58] A. N. Parshin, *Higher-dimensional local fields and L-functions*, Invitation to higher local fields (Münster, 1999), 199–213, Geom.Topol. Monogr., **3**, Geom. Topol. Publ., Coventry, 2000; e-print ArXiv: math.AG/0012151.
- [59] A. N. Parshin, *Integrable systems and local fields*, Commun. Algebra **29**(2001), No.9, 4157–4181; e-print ArXiv: math.AG/0912.1520.
- [60] A. N. Parshin, *Vector Bundles and Arithmetical Groups II*, Proc. Steklov Inst. Math. **241** (2003), 179–191.
- [61] A. N. Parshin, *Numbers as functions: the development of an idea in the Moscow school of algebraic geometry*, Bolibruch, A.A. (ed.) et al., *Mathematical events of the twentieth century*. Berlin: Springer; Moscow: Phasis., 2006, 297–329; e-print arXiv: math/0912.3785.
- [62] A. N. Parshin, *Notes on the Poisson formula (Lectures on Representations of Adelic groups. Part I)*, Saint-Petersburg, POMI, November 2009, and Moscow, MIAN, December 2009, to appear.
- [63] A. N. Parshin, *On holomorphic representations of discrete Heisenberg groups*, Funct. Anal. Appl., **44** (2010), N 2, 92–96.
- [64] A. Pressley, G. Segal, *Loop groups*, Oxford, 1986.
- [65] T. Pytlik, *L^1 -harmonic Analysis on Semi-Direct Products of Abelian groups*, Mh. Math., **93** (1982), 309–328.
- [66] W. Raskind, *Abelian class field theory of arithmetic schemes*, (Jacob, Bill (ed.) et al.), *K-theory and algebraic geometry: connections with quadratic forms and division algebras*. Proc. Symp. Pure Math. **58**, Part 1, Amer. Math. Soc., Providence, RI, 1995, 85–187.
- [67] I. Soprounov, *Residues and tame symbols on toroidal varieties*, e-print arXiv:math AG/0203114.
- [68] J. Tate, *Fourier analysis in number fields and Hecke’s zeta-function*, Thesis, Princeton, 1950 (published in [1]).
- [69] J. Tate, *On the conjectures of Birch and Swinnerton-Dyer and a geometric analog*, Séminaire Bourbaki, 1965/66, exp. 306, 26pp.
- [70] V. S. Varadarajan, *An introduction to Harmonic analysis on semisimple Lie groups*, Cambridge University Press, 1989.
- [71] M.-F. Vignéras, *Représentations l -modulaires d’un groupe réductif p -adique avec $l \neq p$* , Birkhäuser, 1996.
- [72] C. Vafa, E. Witten, *A strong coupling test of S-duality*, Nucl. Phys. B **431** (1994), 3–77.
- [73] A. Weil, *Number theory and algebraic geometry*, Proc. Intern. Congr. Math.(Cambridge, 1950), vol. **2**, 90–110 (= André Weil. Collected Papers, Vol. **1** (1926–1951). Heidelberg-Berlin:Springer, 1980, 442–452.
- [74] A. Weil, *Basic Number Theory*, Springer-Verlag, Berlin, 1967.
- [75] A. J. Wiles, *Modular elliptic curves and Fermat’s last theorem*, Ann. of Math. (2) **141** (1995), no. 3, 443–551.

- [76] A. Yekutieli, *An explicit construction of the Grothendieck residue complex*, *Astérisque*, **208**, 1992.
- [77] D. Zagier, *The Birch-Swinnerton-Dyer conjecture from a naive point of view*, *Arithmetic Algebraic Geometry*, Birkhäuser, Basel, 1991, 377–390.
- [78] A. B. Zheglov, *On wild division algebras over field of power series*, *Sbornik: Mathematics*, **195** (2004), No. 6, 783–817.

Backward Stochastic Differential Equation, Nonlinear Expectation and Their Applications

Shige Peng*

Abstract

We give a survey of the developments in the theory of Backward Stochastic Differential Equations during the last 20 years, including the solutions' existence and uniqueness, comparison theorem, nonlinear Feynman-Kac formula, g -expectation and many other important results in BSDE theory and their applications to dynamic pricing and hedging in an incomplete financial market.

We also present our new framework of nonlinear expectation and its applications to financial risk measures under uncertainty of probability distributions. The generalized form of law of large numbers and central limit theorem under sublinear expectation shows that the limit distribution is a sublinear G -normal distribution. A new type of Brownian motion, G -Brownian motion, is constructed which is a continuous stochastic process with independent and stationary increments under a sublinear expectation (or a nonlinear expectation). The corresponding robust version of Itô's calculus turns out to be a basic tool for problems of risk measures in finance and, more general, for decision theory under uncertainty. We also discuss a type of "fully nonlinear" BSDE under nonlinear expectation.

Mathematics Subject Classification (2010). 60H, 60E, 62C, 62D, 35J, 35K

Keywords. Stochastic differential equation, backward stochastic differential equation, nonlinear expectation, Brownian motion, risk measure, super-hedging, parabolic partial differential equation, g -expectation, G -expectation, g -martingale, G -martingale, Itô integral and Itô's calculus, law of large numbers and central limit theory under uncertainty.

*Partially supported by National Basic Research Program of China (973 Program) (No. 2007CB814906), and NSF of China (No. 10921101). I thank Wei Gang, Li Juan, Hu Ming-shang, Li Xinpeng and the referees for their helpful comments and suggestions about the first version of this paper which significantly enhanced the readability.

School of Mathematics, Shandong University, 250100, Jinan, China.
E-mail: peng@sdu.edu.cn

The theory of backward stochastic differential equations (BSDEs in short) and nonlinear expectation has gone through rapid development in so many different areas of research and applications, such as probability and statistics, partial differential equations (PDE), functional analysis, numerical analysis and stochastic computations, engineering, economics and mathematical finance, that it is impossible in this paper to give a complete review of all the important progresses of recent 20 years. I only limit myself to talk about my familiar subjects. The book edited by El Karoui and Mazliark (1997) provided excellent introductory lecture, as well as a collection of many important research results before 1996, see also [35] with applications in finance. Chapter 7 of the book of Yong and Zhou (1999) is also a very good reference.

Recently, using the notion of sublinear expectations, we have developed systematically a new mathematical tool to treat the problem of risk and randomness under the uncertainty of probability measures. This framework is particularly important for the situation where the involved uncertain probabilities are singular with respect to each other thus we cannot treat the problem within the framework of a given “reference” probability space. The well-known volatility model uncertainty in finance is a typical example. We present a new type of law of large numbers and central limit theorem as well as G -Brownian motion and the corresponding stochastic calculus of Itô’s type under such new sublinear expectation space. A more systematical presentation with detailed proofs and references can be found in Peng (2010a).

This paper is organized as follows. In Section 1 we present BSDE theory and the corresponding g -expectations with some applications in super-hedging and risk measuring in finance; In Section 2 we give a general notion of nonlinear expectations and a new law of large numbers combined with a central limit theorem under a sublinear expectation space. G -Brownian motion under a sublinear expectation– G -expectation, which is a nontrivial generalization of the notion of g expectation, and the related stochastic calculus will be given in Section 3. We also discuss a type of fully “nonlinear BSDE” under G -expectation. For a systematic presentation with detailed proofs of the results on G -expectation, G -Brownian motion and the related calculus, see Peng (2010a).

1. BSDE and g -expectation

1.1. Recall: SDE and related Itô’s stochastic calculus. We consider a typical probability space (Ω, \mathcal{F}, P) where $\Omega = C([0, \infty), \mathbb{R}^d)$, each element ω of Ω is a d -dimensional continuous path on $[0, \infty)$ and $\mathcal{F} = \mathcal{B}(\Omega)$, the Borel σ -algebra of Ω under the distance defined by

$$\rho(\omega, \omega') = \sup_{i \geq 1} \max_{0 \leq t \leq i} |\omega_t - \omega'_t| \wedge 1, \quad \omega, \omega' \in \Omega.$$

We also denote $\{(\omega_{s \wedge t})_{s \geq 0} : \omega \in \Omega\}$ by Ω_t and $\mathcal{B}(\Omega_t)$ by \mathcal{F}_t . Thus an \mathcal{F}_t -measurable random variable is a Borel measurable function of continuous paths

defined on $[0, t]$. For an easy access by a wide audience I will not bother readers with too special vocabulary such as P -null sets, augmentation, etc. We say $\xi \in L^p_P(\mathcal{F}_t, \mathbb{R}^n)$ if ξ is an \mathbb{R}^n -valued \mathcal{F}_t -measurable random variable such that $E_P[|\xi|^p] < \infty$. We also say $\eta \in M^2_P(0, T, \mathbb{R}^n)$ if η is an \mathbb{R}^n -valued stochastic process on $[0, T]$ such that η_t is \mathcal{F}_t -measurable for each $t \in [0, T]$ and $E_P[\int_0^T |\eta_t|^2 dt] < \infty$. Sometimes we omit the space \mathbb{R}^n , if no confusion will be caused.

We assume that under the probability P the canonical process $B_t(\omega) = \omega_t$, $t \geq 0$, $\omega \in \Omega$ is a d -dimensional standard Brownian motion, namely, for each $t, s \geq 0$,

(i) $B_0 = 0$, $B_{t+s} - B_s$ is independent of B_{t_1}, \dots, B_{t_n} , for $t_1, \dots, t_n \in [0, s]$, $n \geq 1$;

(ii) $B_{t+s} - B_s \stackrel{d}{=} N(0, I_d t)$, $s, t \geq 0$, where I_d is the $d \times d$ identical matrix.

P is called a Wiener measure on (Ω, \mathcal{F}) .

In 1942, Japanese mathematician Kiyosi Itô had laid the foundation of stochastic calculus, known as Itô's calculus, to solve the following *stochastic differential equation* (SDE):

$$dX_s = \sigma(X_s)dB_s + b(X_s)ds \tag{1.1}$$

with initial condition $X_s|_{s=0} = x \in \mathbb{R}^n$. Its integral form is:

$$X_t(\omega) = x + \int_0^t \sigma(X_s(\omega))dB_s(\omega) + \int_0^t b(X_s(\omega))ds, \tag{1.2}$$

where $\sigma : \mathbb{R}^n \mapsto \mathbb{R}^{n \times d}$, $b : \mathbb{R}^n \mapsto \mathbb{R}^n$ are given Lipschitz functions. The key part of this formulation is the stochastic integral $\int_0^t \sigma(X_s(\omega))dB_s(\omega)$. In fact, Wiener proved that the typical path of Brownian motion has no bounded variation and thus this integral is meaningless in the Lebesgue-Stieljes sense. Itô's deep insight is that, at each fixed time t , the random variable $\sigma(X_t(\omega))$ is a function of path depending only on ω_s , $0 \leq s \leq t$, or in other words, it is an \mathcal{F}_t -measurable random variable. More precisely, the process $\sigma(X_s(\omega))$ can be in the space $M^2_P(0, T)$. The definition of Itô integral is perfectly applied to a stochastic process η in this space. The integral is defined as a limit of Riemann sums in a "non-anticipating" way: $\int_0^t \eta_s(\omega)dB_s(\omega) \approx \sum \eta_{t_i}(B_{t_{i+1}} - B_{t_i})$. It has zero expectation and satisfies the following Itô's isometry:

$$E \left[\left| \int_0^t \eta_s dB_s \right|^2 \right] = E \left[\int_0^t |\eta_s|^2 ds \right]. \tag{1.3}$$

These two key properties allow Kiyosi Itô to obtain the existence and uniqueness of the solution of SDE (1.2) in a rigorous way. He has also introduced the well-known Itô formula: if $\eta, \beta \in M^2_P(0, T)$, then the following continuous process

$$X_t = x + \int_0^t \eta_s dB_s + \int_0^t \beta_s ds \tag{1.4}$$

is also in $M_P^2(0, T)$ and satisfies the following *Itô formula*: for a smooth function f on $\mathbb{R}^n \times [0, \infty)$,

$$df(X_t, t) = \partial_t f(X_t, t)dt + \nabla_x f(X_t, t)dX_t + \frac{1}{2} \sum_{i,j=1}^n (\eta\eta^*)_{ij} D_{x_i x_j} f(X_t, t)dt. \quad (1.5)$$

Based on this formula, Kiyosi Itô proved that the solution X of SDE (1.1) is a diffusion process with the infinitesimal generator

$$\mathcal{L} = \sum_{i=1}^n b_i(x)D_{x_i} + \frac{1}{2} \sum_{i,j=1}^n (\sigma(x)\sigma^*(x))_{ij} D_{x_i x_j}. \quad (1.6)$$

1.2. BSDE: existence, uniqueness and comparison theorem.

In Itô's SDE (1.1) the initial condition can be also defined at any initial time $t_0 \geq 0$, with a given \mathcal{F}_{t_0} -measurable random variable $X_t|_{t=t_0} = \xi \in L_P^2(\mathcal{F}_{t_0})$. The solution $X_T^{t_0, \xi}$ at time $T > t_0$ is \mathcal{F}_T -measurable. This equation (1.1) in fact leads to a family of mappings $\phi_{T,t}(\xi) = X_T^{t, \xi} : L_P^2(\mathcal{F}_t, \mathbb{R}^n) \mapsto L_P^2(\mathcal{F}_T, \mathbb{R}^n)$, $0 \leq t \leq T < \infty$, determined uniquely by the coefficients σ and b . This family forms what we called *stochastic flow* in the way that the following semigroup property holds: $\phi_{T,t}(\xi) = \phi_{T,s}(\phi_{s,t}(\xi))$, $\phi_{t,t}(\xi) = \xi$, for $t \leq s \leq T < \infty$.

But in many situations we can also meet an inverse type of problem to find a family of mappings $\mathcal{E}_{t,T} : L_P^2(\mathcal{F}_T, \mathbb{R}^m) \mapsto L_P^2(\mathcal{F}_t, \mathbb{R}^m)$ satisfying the following *backward semigroup property*: (see Peng (1997a)) for each $s \leq t \leq T < \infty$ and $\xi \in L_P^2(\mathcal{F}_T, \mathbb{R}^m)$,

$$\mathcal{E}_{s,t}[\mathcal{E}_{t,T}[\xi]] = \mathcal{E}_{s,T}[\xi], \text{ and } \mathcal{E}_{T,T}[\xi] = \xi.$$

$\mathcal{E}_{t,T}$ maps an \mathcal{F}_T -measurable random vector ξ , which can only be observed at time T , backwardly to an \mathcal{F}_t -measurable random vector $\mathcal{E}_{t,T}[\xi]$ at $t < T$. A typical example is the calculation of the value, at the current time t , of the risk capital reserve for a risky position with maturity time $T > t$. In fact this type of problem appears in many decision making problems.

But, in general, Itô's stochastic differential equation (1.1) cannot be applied to solve this type of problem. Indeed, if we try to use (1.1) to solve X_t at time $t < T$ for a given terminal value $X_T = \xi \in L_P^2(\mathcal{F}_T)$, then

$$X_t = X_T - \int_t^T b(X_s)ds - \int_t^T \sigma(X_s)dB_s.$$

In this case the "solution" X_t is still, in general, \mathcal{F}_T -measurable and thus $b(X)$ and $\sigma(X)$ become anticipating processes. It turns out that not only this formulation cannot ensure $X_t \in L_P^2(\mathcal{F}_t)$, the stochastic integrand $\sigma(X)$ also becomes illegal within the framework of Itô's calculus.

After the exploration over a long period of time, we eventually understand that what we need is the following new type of backward stochastic differential equation

$$Y_t = Y_T + \int_t^T g(s, Y_s, Z_s) ds - \int_t^T Z_s dB_s, \tag{1.7}$$

or in its differential form

$$dY_s = -g(s, Y_s, Z_s) ds + Z_s dB_s, \quad s \in [0, T].$$

In this equation (Y, Z) is a pair of unknown non-anticipating processes and the equation has to be solved for a given terminal condition $Y_T \in L^2_P(\mathcal{F}_T)$ (but Z_T is not given). In contrast to SDE (1.1) in which two coefficients σ and b are given functions of one variable x , here we have only one coefficient g , called the generator of the BSDE, which is a function of two variables (y, z) . Bismut (1973) was the first to introduce a BSDE for the case where g is a linear or (for $m = 1$) a convex function of (y, z) in his pioneering work on maximum principle of stochastic optimal control systems with an application in financial markets (see Bismut (1975)). See also a systematic study by Bensoussan (1982) on this subject. The following existence and uniqueness theorem is a fundamental result:

Theorem 1.1. (Pardoux and Peng (1990)) *Let $g : \Omega \times [0, \infty) \times \mathbb{R}^m \times \mathbb{R}^{m \times d}$ be a given function such that $g(\cdot, y, z) \in M^2_P(0, T, \mathbb{R}^m)$ for each T and for each fixed $y \in \mathbb{R}^m$ and $z \in \mathbb{R}^{m \times d}$, and let g be a Lipschitz function of (y, z) , i.e., there exists a constant μ such that*

$$|g(\omega, t, y, z) - g(\omega, t, y', z')| \leq \mu(|y - y'| + |z - z'|), \quad y, y' \in \mathbb{R}^m, \quad z, z' \in \mathbb{R}^{m \times d}.$$

Then, for each given $Y_T = \xi \in L^2_P(\mathcal{F}_T, \mathbb{R}^m)$, there exists a unique pair of processes $(Y, Z) \in M^2_P(0, T, \mathbb{R}^m \times \mathbb{R}^{m \times d})$ satisfying BSDE (1.7). Moreover, Y has continuous path, a.s. (almost surely).

We denote $\mathcal{E}_{t,T}^g[\xi] = Y_t, t \in [0, T]$. From the above theorem, we have obtained a family of mappings

$$\mathcal{E}_{s,t}^g : L^2_P(\mathcal{F}_t) \mapsto L^2_P(\mathcal{F}_s), \quad 0 \leq s \leq t < \infty, \tag{1.8}$$

with “backward semigroup property” (see Peng (2007a)):

$$\mathcal{E}_{s,t}^g[\mathcal{E}_{t,T}^g[\xi]] = \mathcal{E}_{s,T}^g[\xi], \quad \mathcal{E}_{T,T}^g[\xi] = \xi, \quad \text{for } s \leq t \leq T < \infty, \quad \forall \xi \in L^2(\mathcal{F}_T).$$

In 1-dimensional case, i.e., $m = 1$, the above property is called “recursive” in utility theory in economics. In fact, independent of the above result, Duffie

and Epstein (1992) introduced the following class of recursive utilities:

$$-dY_t = \left[f(c_t, Y_t) - \frac{1}{2} A(Y_t) Z_t^T Z_t \right] dt - Z_t dB_t, \quad Y_T = \xi, \quad (1.9)$$

where the function f is called a generator, and A a “variance multiplier”.

In 1-dimensional case, we have the *comparison theorem* of BSDE, introduced by Peng (1992b) and improved by El Karoui, Peng and Quenez (1997).

Theorem 1.2. *We assume the same condition as in the above theorem for two generators g_1 and g_2 . We also assume that $m = 1$. If $\xi_1 \geq \xi_2$ and $g_1(t, y, z) \geq g_2(t, y, z)$ for each (t, y, z) , a.s., then we have $\mathcal{E}_{t,T}^{g_1}[\xi_1] \geq \mathcal{E}_{t,T}^{g_2}[\xi_2]$, a.s.*

This theorem is a powerful tool in the study of 1-dimensional BSDE theory as well as in many applications. In fact it plays the role of “maximum principle” in the PDE theory. There are two typical theoretical situations where this comparison theorem plays an essential role. The first one is the existence theorem of BSDE, obtained by Lepeltier and San Martin (1997), for the case when g is only a continuous and linear growth function in (y, z) (the uniqueness under the condition of uniform continuity in z was obtained by Jia (2008)).

The second one is also the existence and uniqueness theorem, in which g satisfies quadratic growth condition in z and some local Lipschitz conditions, obtained by Kobylanski (2000) for the case where the terminal value ξ is bounded. The existence for unbounded ξ was solved only very recently by Briand and Hu (2006).

A specially important model of symmetric matrix valued BSDEs with a quadratic growth in (y, z) is the so-called stochastic Riccati equation. This equation is applied to solve the optimal feedback for linear-quadratic stochastic control system with random coefficients. Bismut (1976) solved this problem for a situation where there is no control variable in the diffusion term, and then raised the problem for the general situation. The problem was also listed as one of several open problems in BSDEs in Peng (1999a). It was finally completely solved by Tang (2003), whereas other problems in the list are still open. Only few results have been obtained for multi-dimensional BSDEs of which the generator g is only assumed to be (bounded or with linear growth) continuous function of (y, z) , see Hamadène, Lepeltier and Peng (1997) for a proof in a Markovian case. Recently Buckdahn, Engelbert and Rascanu (2004) introduced a notion of weak solutions for BSDEs and obtained the existence for the case where g does not depend on z .

The above mentioned stochastic Riccati equation is used to solve a type of backward stochastic partial differential equations (BSPDEs), called stochastic Hamilton-Jacobi-Bellman equation (SHJB equations) in order to solve the value function of an optimal controls for non-Markovian systems, see Peng (1992). Englezos and Karatzas (2009) characterized the value function of a utility maximization problem with habit formation as a solution of the corresponding stochastic HJB equation. A linear BSPDE was introduced by Bensoussan

(1992). It serves as the adjoint equation for optimal control systems with partial information, see Nagai (2005), Oksendal, Proske and Zhang (2005), or for optimal control system governed by a stochastic PDE, see Zhou (1992). For the existence, uniqueness and regularity of the adapted solution of a BSPDE, we refer to the above mentioned papers as well as Hu and Peng (1991), Ma and Yong (1997,1999), Tang (2005) among many others. The existence and uniqueness of a fully nonlinear backward HJB equation formulated in Peng (1992) was then listed in Peng (1999a) as one of open problems in BSDE theory. The problem is still open.

The problem of multi-dimensional BSDEs with quadratic growth in z was partially motivated from the heat equation of harmonic mappings, see Elworthy (1993). Dynamic equilibrium pricing models and non-zero sum stochastic differential games also lead to such type of BSDE. There have been some very interesting progresses of existence and uniqueness in this direction, see Darling (1995), Blache (2005). But the main problem remains still largely open. One possible direction is to find a tool of “comparison theorem” in the multi-dimensional situation. An encouraging progress is the so called backward viability properties established by Buckdahn, Quincampoix and Rascanu (2000).

1.3. BSDE, PDE and stochastic PDE. It was an important discovery to find the relation between BSDEs and (systems of) quasilinear PDEs of parabolic and elliptic types. Assume that $X_s^{t,x}$, $s \in [t, T]$, is the solution of SDE (1.1) with initial condition $X_s^{t,x}|_{s=t} = x \in \mathbb{R}^n$, and consider a BSDE defined on $[t, T]$ of the following type

$$dY_s^{t,x} = -g(X_s^{t,x}, Y_s^{t,x}, Z_s^{t,x})ds + Z_s^{t,x} dB_s, \tag{1.10}$$

with terminal condition $Y_T^{t,x} = \varphi(X_T^{t,x})$. Then we can use this BSDE to solve a quasilinear PDE. We consider a typical case $m = 1$:

Theorem 1.3. *Assume that b, σ, φ are given Lipschitz functions on \mathbb{R}^n with values in $\mathbb{R}^n, \mathbb{R}^{n \times d}$ and \mathbb{R} respectively, and that g is a real valued Lipschitz function on $\mathbb{R}^n \times \mathbb{R} \times \mathbb{R}^d$. Then we have the following relation $Y_s^{t,x} = \mathcal{E}_{s,T}^g[\varphi(X_T^{t,x})] = u(s, X_s^{t,x})$. In particular, $u(t, x) = Y_t^{t,x}$, where $u = u(t, x)$ is the unique viscosity solution of the following parabolic PDE defined on $(t, x) \in [0, T] \times \mathbb{R}^n$:*

$$\partial_t u + \mathcal{L}u + g(x, u, \sigma^* Du) = 0, \tag{1.11}$$

with terminal condition $u|_{t=T} = \varphi$. Here $Du = (D_{x_1} u, \dots, D_{x_n} u)$

The relation $u(t, x) = Y_t^{t,x}$ is called a nonlinear Feynman-Kac formula. Peng (1991a) used a combination of BSDE and PDE method and established this relation for non-degenerate situations under which (1.11) has a classical solution. In this case (1.11) can also be a system of PDE, i.e., $m > 1$, and we also have $Z_s^{t,x} = \sigma^* Du(s, X_s^{t,x})$. Later Peng (1991b), (1992a) used a stochastic

control argument and the notion of viscosity solution to prove a more general version of above theorem for $m = 1$. Using a simpler argument, Pardoux and Peng (1992) provided a proof for a particular case, which is the above theorem. They have introduced a new probabilistic method to prove the regularity of u , under the condition that all coefficients are regular enough, but the PDE is possibly degenerate. They then proved that the function u is also a classical regular solution of (1.11). This proof is also applied to the situation $m > 1$.

The above nonlinear Feynman-Kac formula is not only valid for a system of parabolic equation (1.11) with Cauchy condition but also for the corresponding elliptic PDE $\mathcal{L}u + g(x, u, \sigma^* Du) = 0$ defined on an open subset $\mathcal{O} \subset \mathbb{R}^n$ with boundary condition $u|_{x \in \mathcal{O}} = \varphi$. In fact, $u = u(x)$, $x \in \mathcal{O}$ can be solved by defining $u(x) = \mathcal{E}_{0, \tau_x}^g[\varphi(X_{\tau_x}^{0,x})]$, where $\tau_x = \inf\{s \geq 0 : X_s^{0,x} \notin \mathcal{O}\}$. In this case some type of non-degeneracy condition of the diffusion process X and a monotonicity condition of g with respect to y are required, see Peng (1991a). The above results imply that we can solve PDEs by using BSDEs and, conversely, solve some BSDEs by PDEs.

In principle, once we have obtained a BSDE driven by a Markov process X in which the final condition ξ at time T depends only on X_T , and the generator g also depends on the state X_t at each time t , then the corresponding solution is also state dependent, namely $Y_t = u(t, X_t)$, where u is the solution of the corresponding quasilinear evolution equation. Once ξ and g are path functions of X , then the solution $Y_t = \mathcal{E}_{t,T}^g[\xi]$ of the BSDE becomes also path dependent. In this sense, we can say that PDE (1.11) is in fact a “state dependent BSDE”, and BSDE gives us a new generalization of PDE—“path-dependent PDE” of parabolic and elliptic types.

The following backward doubly stochastic differential equation (BDSDE) smartly combines two essentially different SDEs, namely, an SDE and a BSDE into one equation:

$$dY_t = -\bar{g}_t(Y_t, Z_t)dt - \bar{h}_t(Y_t, Z_t) \downarrow dW_t + Z_t dB_t, \quad Y_T = \xi, \quad (1.12)$$

where W and B are two mutually independent Brownian motions. In (1.12) all processes at time t are required to be measurable functions on $\Omega_t \times \Omega_t^W$ where Ω_t^W is the space of the paths of $(W_T - W_s)_{t \leq s \leq T}$ and $\downarrow dW_t$ denotes the “backward Itô’s integral” ($\approx \sum_i h_{t_i}(W_{t_i} - W_{t_{i-1}})$). We also assume that \bar{g} and \bar{h} are Lipschitz functions of (y, z) and, in addition, the Lipschitz constant of \bar{h} with respect to z is assumed to be strictly less than 1. Pardoux and Peng (1994) obtained the existence and uniqueness of (1.12) and proved that, under a further assumption:

$$\bar{g}_t(\omega, y, z) = g(X_t(\omega), y, z), \quad \bar{h}_t(y, z) = h(X_t(\omega), y, z), \quad \xi(\omega) = \varphi(X_T(\omega)), \quad (1.13)$$

where X is the solution of (1.1) and where g, h, b, σ, φ are sufficiently regular with $|\partial_z \bar{g}| < \mu$, $\mu < 1$, then $Y_t = u(t, X_t)$, $Z_t = \sigma^* Du(t, X_t)$. Here u is a smooth

solution of the following stochastic PDE:

$$du_t(x, \omega) = -(\mathcal{L}u + g(x, u, \sigma^* Du))dt + h(x, u, \sigma^* Du) \downarrow dW_t \tag{1.14}$$

with terminal condition $u|_{t=T} = \varphi(X_T)$. Here we see again a path-interpretation of a nonlinear stochastic PDE.

Another approach to give a probabilistic interpretation of some infinite dimensional Hamilton-Jacobi-Bellman equations is to consider a generator of a BSDE of the form $g(X_t, y, z)$ where X is a solution of the following type of infinite dimensional SDE

$$dX_s = [\mathcal{A}X_s + b(X_s)]ds + \sigma(X_s)dB_s, \tag{1.15}$$

where \mathcal{A} is some given infinitesimal generator of a semigroup and B is, in general, an infinite dimensional Brownian motion. We refer to Fuhrman and Tessitore (2002) for the related references.

Up to now we have only discussed BSDEs driven by a Brownian motion. In principle a BSDE can be driven by a more general martingale. See Kabanov (1978), Tang and Li (1994) for optimal control system with jumps, where the adjoint equation is a linear BSDE with jumps. For results of the existence, uniqueness and regularity of solutions, see Situ (1996), El Karoui and Huang (1997), Barles, Buckdahn and Pardoux (1997), Nualart and Schoutens (2001) and many other results on this subject.

1.4. Forward-backward SDE. Nonlinear Feynman-Kac formula can be used to solve a nonlinear PDE of form (1.11) by a BSDE (1.10) coupled with an SDE (1.1). In this situation BSDE (1.10) and forward SDE (1.1) are only partially coupled. A fully coupled system of SDE and BSDE is called a forward-backward stochastic differential equation (FBSDE). It has the following form:

$$\begin{aligned} dX_t &= b(t, X_t, Y_t, Z_t)dt + \sigma(t, X_t, Y_t, Z_t)dB_t, \quad X_0 = x \in \mathbb{R}^n, \\ -dY_t &= f(t, X_t, Y_t, Z_t)dt - Z_tdB_t, \quad Y_T = \varphi(X_T). \end{aligned}$$

Note that it is not realistic to only assume, as in a BSDE framework, that the coefficients b, σ, f and φ are just Lipschitz functions in (x, y, z) . A counterexample can be easily constructed. Therefore additional conditions are needed for the well-posedness of the problem. Antonelli (1993) provided a counterexample and solved a special type of FBSDE. Then Ma, Protter and Yong (1994) have proposed a four-step scheme method of FBSDE. This method uses some classical result of PDE for which σ is assumed to be independent of z and strictly non-degenerate. The coefficients f, b, σ and φ are also assumed to be deterministic functions. For the case $\dim(x) = \dim(y) = n$, Hu and Peng (1995) proposed a new type of monotonicity condition: the function $A = (-f, b, \sigma)$ is said to be a monotone function in $\gamma = (x, y, z)$ if there exists a positive constant μ such that

$$(A(\gamma) - A(\gamma'), \gamma - \gamma') \leq -\mu|\gamma - \gamma'|^2, \quad \gamma, \gamma' \in \mathbb{R}^n \times \mathbb{R}^n \times \mathbb{R}^{n \times d}.$$

With this condition and $(\varphi(x) - \varphi(x'), x - x') \geq 0$, for each $x, x' \in \mathbb{R}^n$, the above FBSDE has a unique solution. The proof of the uniqueness is immediate and the existence was established by using a type of continuation method (see Peng (1991a), and Yong (1997)). This method does not need to assume coefficients to be deterministic. Peng and Wu (1999) have weakened the monotonicity condition and the constraint $\dim(x) = \dim(y)$, Wu (1999) provided a new type of comparison theorem. Another type of existence and uniqueness theorem under different conditions was obtained by Pardoux and Tang (1999). We also refer to the book of Ma and Yong (1999) for a systematic presentation on this subject. For time-symmetric forward-backward stochastic differential equations and its relation with stochastic optimality, see Peng and Shi (2003), Han, Peng and Wu (2010).

1.5. Reflected BSDE and other types of constrained BSDE.

If (Y, Z) solves

$$-dY_s = g(s, Y_s, Z_s)ds - Z_s dB_s + dK_s, \quad Y_T = \xi, \quad (1.16)$$

where K is a càdlàg (continu à droite avec limite à gauche, or in English, right continuous with left limit) and increasing process with $K_0 = 0$ and $K_t \in L_P^2(\mathcal{F}_t)$, then Y or (Y, Z, K) is called a *supersolution* of the BSDE, or *g-supersolution*. This notion is often used for constrained BSDEs. A typical one is, for a given terminal condition ξ and a continuous adapted process $(L_t)_{t \in [0, T]}$ to find a smallest *g-supersolution* (Y, Z, K) such that $Y \geq L$, and $Y_T = \xi$. This problem was initiated in El Karoui, Kapoudjian, Pardoux, Peng and Quenez (1997). They have proved that this problem is equivalent to finding a triple (Y, Z, K) satisfying (1.16) and the following reflecting condition of Skorohod type:

$$Y_s \geq L_s, \quad \int_0^T (Y_s - L_s) dK_s = 0. \quad (1.17)$$

The existence, uniqueness and continuous dependence theorems were obtained. Moreover, a new type of nonlinear Feynman-Kac formula was introduced: if all coefficients are given as in Theorem 1.3 and $L_s = \Phi(X_s)$ where Φ satisfies the same condition as φ , then we have $Y_s = u(s, X_s)$, where $u = u(t, x)$ is the solution of the following variational inequality:

$$\min\{\partial_t u + \mathcal{L}u + g(x, u, \sigma^* Du), u - \Phi\} = 0, \quad (t, x) \in [0, T] \times \mathbb{R}^n, \quad (1.18)$$

with terminal condition $u|_{t=T} = \varphi$. They also proved that this reflected BSDE is a powerful tool to deal with contingent claims of American types in a financial market with constraints.

BSDE reflected within two barriers, for a lower one L and an upper one U was first investigated by Cvitanic and Karatzas (1996) where a type of nonlinear Dynkin games was formulated for a two-player model with zero-sum utility, each player chooses his own optimal exit time. See also Rascano (2009).

There are many other generalizations on the above problem of RBSDEs, e.g. L and U can be càdlàg or even L^2 -processes and g admits a quadratic growth condition, see e.g. Hamadene (2002), Lepeltier and Xu (2005), Peng and Xu (2005) and many other related results. For BSDEs applied to optimal switching, see Hamadene and Jeanblanc (2007). For the related multi-dimensional BSDEs with oblique reflection, see Ramasubramanian (2002), Carmona and Ludkovski (2008), Hu and Tang (2010) and Hamadene and Zhang (2010).

A more general case of constrained BSDE is to find the smallest g -supersolution (Y, Z, K) with constraint $(Y_t, Z_t) \in \Gamma_t$ where, for each $t \in [0, T]$, Γ_t is a given closed subset in $\mathbb{R} \times \mathbb{R}^d$. This problem was studied in El Karoui and Quenez (1995) and in Cvitanic and Karatzas (1993), El Karoui et al (1997) for the problem of superhedging in a market with constrained portfolios, in Cvitanic, Karatzas and Soner (1998) for BSDE with a convex constraint and in Peng (1999) with an arbitrary closed constraint.

1.6. g -expectation and g -martingales. Let $\mathcal{E}_{t,T}^g[\xi]$ be the solution of a real valued BSDE (1.7), namely $m = 1$, for a given generator g satisfying an additional assumption $g|_{z=0} \equiv 0$. Peng (1997b) studied this problem by introducing a notion of g -expectation:

$$\mathcal{E}^g[\xi] := \mathcal{E}_{0,T}^g[\xi] : \xi \in \bigcup_{T \geq 0} L^2_P(\mathcal{F}_T) \mapsto \mathbb{R}. \tag{1.19}$$

\mathcal{E}^g is then a monotone functional preserving constants: $\mathcal{E}^g[c] = c$. A significant character of this nonlinear expectation is that, thanks to the backward semigroup properties of $\mathcal{E}_{s,t}^g$, it keeps all dynamic properties of classical linear expectations: the corresponding conditional expectation, given \mathcal{F}_t , is uniquely defined by $\mathcal{E}^g[\xi|\mathcal{F}_t] = \mathcal{E}_{t,T}^g[\xi]$. It satisfies:

$$\mathcal{E}^g[\mathcal{E}^g[\xi|\mathcal{F}_s]|\mathcal{F}_t] = \mathcal{E}^g[\xi|\mathcal{F}_{t \wedge s}], \quad \mathcal{E}^g[\mathbf{1}_A \xi|\mathcal{F}_t] = \mathbf{1}_A \mathcal{E}^g[\xi|\mathcal{F}_t], \quad \forall A \in \mathcal{F}_t. \tag{1.20}$$

This notion allows us to establish a nonlinear g -martingale theory, which plays the same important role as the martingale theory in the classical probability theory. An important theorem is the so-called g -supermartingale decomposition theorem obtained in Peng (1999). This theorem does not need to assume that $g|_{z=0} = 0$. It claims that, if Y is a càdlàg g -supermartingale, namely,

$$\mathcal{E}_{t,T}^g[Y_T] \leq Y_t, \text{ a.s. } 0 \leq t \leq T,$$

then it has the following unique decomposition: there exists a unique predictable, increasing and càdlàg process A such that Y solves

$$-dY_t = g(t, Y_t, Z_t)dt + dA_t - Z_t dB_t.$$

In other words, Y is a g -supersolution of type (1.16).

A theoretically very interesting and practically important question is: given a family of expectations $\mathcal{E}_{s,t}[\cdot] : L^2_P(\mathcal{F}_t) \mapsto L^2_P(\mathcal{F}_s)$, $0 \leq s \leq t < \infty$, satisfying

the same backward dynamically consistent properties of a g -expectation (1.20), can we find a function g such that $\mathcal{E}_{s,t} \equiv \mathcal{E}_{s,t}^g$? The first result was obtained in Coquet, Hu, Memin and Peng (2001) (see also lecture notes of a CIME course of Peng (2004a)): under an additional condition such that \mathcal{E} is dominated by a g_μ -expectation with $g_\mu(z) = \mu|z|$ for a large enough constant $\mu > 0$, namely

$$\mathcal{E}_{s,t}[\xi] - \mathcal{E}_{s,t}[\xi'] \leq \mathcal{E}_{s,t}^{g_\mu}[\xi - \xi'], \quad (1.21)$$

then there exists a unique function $g = g(t, \omega, z)$ satisfying

$$g(\cdot, z) \in M_P^2(0, T), \quad g(t, z) - g(t, z') \leq \mu|z - z'|, \quad z, z' \in \mathbb{R}^d,$$

such that $\mathcal{E}_{s,t}[\xi] \equiv \mathcal{E}_{s,t}^g[\xi]$, for all $\xi \in L_P^2(\mathcal{F}_t)$, $s \leq t$. For a concave dynamic expectation with an assumption much weaker than the above domination condition, we can still find a function $g = g(t, z)$ with possibly singular values, see Delbaen, Peng and Rosazza Gianin (2009). Peng (2005a) proved the case without the assumption of constant preservation, the domination condition of \mathcal{E}^{g_μ} was also weakened by $g_\mu = \mu(|y| + |z|)$. The result is: there is a unique function $g = g(t, \omega, y, z)$ such that $\mathcal{E}_{s,t} \equiv \mathcal{E}_{s,t}^g$, where g is a Lipschitz function:

$$g(t, y, z) - g(t, y', z') \leq \mu(|y - y'| + |z - z'|), \quad y, y' \in \mathbb{R}, \quad z, z' \in \mathbb{R}^d.$$

In practice, the above criterion is very useful to test whether a dynamic pricing mechanism of contingent contracts can be represented by a concrete function g . Indeed, it is an important test in order to establish and maintain a system of dynamically consistent risk measure in finance as well as in other industrial domains. We have collected some data in financial markets and realized a large scale computation. The results of the test strongly support the criterion (1.21) (see Peng (2006b) with numerical calculations and data tests realized by Chen and Sun).

Chen, Chen and Davison (2005) proved that there is an essential difference between g -expectation and the well-known Choquet-expectation, which is obtained via the Choquet integral. Since g -expectation is essentially equivalent to a dynamical expectation under a Wiener probability space, their result seems to tell us that, in general, a nontrivially nonlinear Choquet expectation cannot be a dynamical one. This point of view is still to be clarified.

1.7. BSDE applied in finance. The above problem of constrained BSDE was motivated from hedging problem with constrained portfolios in a financial market. El Karoui et al (1997) initiated this BSDE approach in finance and stimulated many very interesting results. We briefly present a typical model of continuous asset pricing in a financial market: the basic securities consist of $1 + d$ assets, a riskless one, called bond, and d risky securities, called stocks. Their prices are governed by

$$dP_t^0 = P_t^0 r dt, \quad \text{for the bond,}$$

and

$$dP_t^i = P_t^i \left[b^i dt + \sum_{j=1}^d \sigma^{ij} dB_t^j \right], \text{ for the } i\text{th stock, } i = 1, \dots, d.$$

Here we only consider the situation where the matrix $\sigma = (\sigma^{ij})_{i,j=1}^d$ is invertible. The degenerate case can be treated by constrained BSDE. We consider a small investor whose investment behavior cannot affect market prices and who invests at time $t \in [0, T]$ the amount π_t^i of his wealth Y_t in the i th security, for $i = 0, 1, \dots, d$, thus $Y_t = \pi_t^0 + \dots + \pi_t^d$. If his investment strategy is self-financing, then we have $dY_t = \sum_{i=0}^d \pi_t^i dP_t^i / P_t^i$, thus

$$dY_t = rY_t dt + \pi_t^* \sigma \theta dt + \pi_t^* \sigma dB_t, \quad \theta^i = \sigma^{-1}(b^i - r), \quad i = 1, \dots, d.$$

Here we always assume that all involved processes are in $M_P^2(0, T)$. A strategy $(Y_t, \{\pi_t^i\}_{i=1}^d)_{t \in [0, T]}$ is said to be feasible if $Y_t \geq 0, t \in [0, T]$, a.s. A European contingent claim settled at time T is a non-negative random variable $\xi \in L_P^2(\mathcal{F}_T)$. A feasible strategy (Y, π) is called a hedging strategy against a contingent claim ξ at the maturity T if it satisfies:

$$dY_t = rY_t dt + \pi_t^* \sigma \theta dt + \pi_t^* \sigma dB_t, \quad Y_T = \xi.$$

Observe that $(Y, \pi^* \sigma)$ can be regarded as a solution of BSDE and the solution is automatically feasible by the comparison theorem (Theorem 1.2). It is called a super-hedging strategy if there exists an increasing process K_t , often called an accumulated consumption process, such that

$$dY_t = rY_t dt + \pi_t^* \sigma \theta dt + \pi_t^* \sigma dB_t - dK_t, \quad Y_T = \xi.$$

This type of strategy are often applied in a constrained market in which certain constraint $(Y_t, \pi_t) \in \Gamma$ are imposed. Observe that a real market has many frictions and constraints. An example is the common case where interest rate R for borrowing money is higher than the bond rate r . The above equation for hedging strategy becomes

$$dY_t = rY_t dt + \pi_t^* \sigma \theta dt + \pi_t^* \sigma dB_t - (R - r) \left[\sum_{i=1}^d \pi_t^i - Y_t \right]^+ dt, \quad Y_T = \xi,$$

where $[\cdot]^+ = \max\{\cdot, 0\}$. A short selling constraint $\pi_t^i \geq 0$ is also very typical. The method of constrained BSDE can be applied to this type of problems. BSDE theory provides powerful tools to the robust pricing and risk measures for contingent claims. For more details see El Karoui et al. (1997). For the dynamic risk measure under Brownian filtration see Rosazza Gianin (2006), Delbaen et al (2009). Barrieu and El Karoui (2004) revealed the relation between the

inf-convolution of dynamic convex risk measures and the corresponding one for the generators of the BSDE, Rouge and El Karoui (2000) solved a utility maximization problem by using a type of quadratic BSDEs. Hu, Imkeller and Müller (2005) further considered the problem under a non-convex portfolio constraint where BMO martingales play a key role. For investigations of BMO martingales in BSDE and dynamic nonlinear expectations see also Barrieu, Cazanave, and El Karoui (2008), Hu, Ma, Peng and Yao (2008) and Delbaen and Tang (2010).

There are still so many important issues on BSDE theory and its applications. The well-known paper of Chen and Epstein (2002) introduced a continuous time utility under probability model uncertainty using g -expectation. The Malliavin derivative of a solution of BSDE (see Pardoux and Peng (1992), El Karoui et al (1997)) leads to a very interesting relation $Z_t = D_t Y_t$. There are actually very active researches on numerical analysis and calculations of BSDE, see Douglas, Ma and Protter (1996), Ma and Zhang (2002), Zhanng (2004), Bouchard and Touzi (2004), Peng and Xu (2003), Gobet, Lemor and Warin (2005), Zhao et al (2006), Delarue and Menozzi (2006). We also refer to stochastic differential maximization and games with recursive or other utilities (see Peng (1997a), Pham (2004), Buckdahn and Li (2008)), Mean-field BSDE (see Buckdahn et al (2009)).

2. Nonlinear Expectations and Nonlinear Distributions

The notion of g expectations introduced via BSDE can be used as an idea tool to treat the randomness and risk in the case of the uncertainty of probability models, see Chen and Epstein (2002), but with the following limitation: all the involved uncertain probability measures are absolutely continuous with respect to the “reference probability” P . But for the well-known problem of volatility model uncertainty in finance, there is an uncountable number of unknown probabilities which are singular from each other.

The notion of sublinear expectations is a powerful tool to solve this problem. We give a survey on the recent development of G -expectation theory. More details with proofs and historical remarks can be found in a book of Peng (2010a). For references of decision theory under uncertainty in economics, we refer to the collection of papers edited by Gilboa (2004).

2.1. Sublinear expectation space $(\Omega, \mathcal{H}, \hat{\mathbb{E}})$. We define from a very basic level of a nonlinear expectation.

Let Ω be a given set. A vector lattice \mathcal{H} is a linear space of real functions defined on Ω such that all constants are belonging to \mathcal{H} and if $X \in \mathcal{H}$ then $|X| \in \mathcal{H}$. This lattice is often denoted by (Ω, \mathcal{H}) . An element $X \in \mathcal{H}$ is called a random variable.

We denote by $C_{Lat}(\mathbb{R}^n)$ the smallest lattice of real functions defined on \mathbb{R}^n containing the following $n + 1$ functions (i) $\varphi_0(x) \equiv c$, (ii) $\varphi_i(x) = x_i$, for $x = (x_1, \dots, x_n) \in \mathbb{R}^n$, $i = 1, \dots, n$.

We also use $C_{Lip}(\mathbb{R}^n)$ (resp. $C_{l.Lip}(\mathbb{R}^n)$) for the space of all Lipschitz (resp. locally Lipschitz) real functions on \mathbb{R}^n . It is clear that $C_{Lat}(\mathbb{R}^n) \subset C_{Lip}(\mathbb{R}^n) \subset C_{l.Lip}(\mathbb{R}^n)$. Any elements of $C_{l.Lip}(\mathbb{R}^n)$ can be locally uniformly approximated by a sequence in $C_{Lat}(\mathbb{R}^n)$.

It is clear that if $X_1, \dots, X_n \in \mathcal{H}$, then $\varphi(X_1, \dots, X_n) \in \mathcal{H}$, for each $\varphi \in C_{Lat}(\mathbb{R}^n)$.

Definition 2.1. A *nonlinear expectation* $\hat{\mathbb{E}}$ defined on \mathcal{H} is a functional $\hat{\mathbb{E}} : \mathcal{H} \mapsto \mathbb{R}$ satisfying the following properties for all $X, Y \in \mathcal{H}$:

- Monotonicity: If $X \geq Y$ then $\hat{\mathbb{E}}[X] \geq \hat{\mathbb{E}}[Y]$.
- Constant preserving: $\hat{\mathbb{E}}[c] = c$.

$\hat{\mathbb{E}}$ is called a *sublinear expectation* if it furthermore satisfies

$$\hat{\mathbb{E}}[X + \lambda Y] \leq \hat{\mathbb{E}}[X] + \lambda \hat{\mathbb{E}}[Y], \quad \forall X, Y \in \mathcal{H}, \lambda \geq 0.$$

If it further satisfies $\hat{\mathbb{E}}[-X] = -\hat{\mathbb{E}}[X]$ for $X \in \mathcal{H}$, then $\hat{\mathbb{E}}$ is called a *linear expectation*. The triple $(\Omega, \mathcal{H}, \hat{\mathbb{E}})$ is called a *nonlinear (resp. sublinear, linear) expectation space*.

We are particularly interested in sublinear expectations. In statistics and economics, this type of functionals was studied by, among many others, Huber (1981) and then explored by Walley (1991).

Recently a new notion of coherent risk measures in finance caused much attention to the study of such type of sublinear expectations and applications to risk controls, see the seminal paper of Artzner, Delbaen, Eber and Heath (1999) as well as Föllmer and Schied (2004).

The following result is well-known as representation theorem. It is a direct consequence of Hahn-Banach theorem (see Delbaen (2002), Föllmer and Schied (2004), or Peng (2010a)).

Theorem 2.2. Let $\hat{\mathbb{E}}$ be a sublinear expectation defined on (Ω, \mathcal{H}) . Then there exists a family of linear expectations $\{E_\theta : \theta \in \Theta\}$ on (Ω, \mathcal{H}) such that

$$\hat{\mathbb{E}}[X] = \max_{\theta \in \Theta} E_\theta[X].$$

A sublinear expectation $\hat{\mathbb{E}}$ on (Ω, \mathcal{H}) is said to be regular if for each sequence $\{X_n\}_{n=1}^\infty \subset \mathcal{H}$ such that $X_n(\omega) \downarrow 0$, for ω , we have $\hat{\mathbb{E}}[X_n] \downarrow 0$. If $\hat{\mathbb{E}}$ is regular then from the above representation we have $E_\theta[X_n] \downarrow 0$ for each $\theta \in \Theta$. It follows

from Daniell-Stone theorem that there exists a unique (σ -additive) probability measure P_θ defined on $(\Omega, \sigma(\mathcal{H}))$ such that

$$E_\theta[X] = \int_{\Omega} X(\omega) dP_\theta(\omega), \quad X \in \mathcal{H}.$$

The above representation theorem of sublinear expectation tells us that to use a sublinear expectation for a risky loss X is equivalent to take the upper expectation of $\{E_\theta : \theta \in \Theta\}$. The corresponding model uncertainty of probabilities, or ambiguity, is the subset $\{P_\theta : \theta \in \Theta\}$. The corresponding uncertainty of distributions for an n -dimensional random variable X in \mathcal{H} is

$$\{F_X(\theta, A) := P_\theta(X \in A) : A \in \mathcal{B}(\mathbb{R}^n)\}.$$

2.2. Distributions and independence. We now consider the notion of the distributions of random variables under sublinear expectations. Let $X = (X_1, \dots, X_n)$ be a given n -dimensional random vector on a nonlinear expectation space $(\Omega, \mathcal{H}, \hat{\mathbb{E}})$. We define a functional on $C_{Lat}(\mathbb{R}^n)$ by

$$\hat{\mathbb{F}}_X[\varphi] := \hat{\mathbb{E}}[\varphi(X)] : \varphi \in C_{Lat}(\mathbb{R}^n) \mapsto \mathbb{R}.$$

The triple $(\mathbb{R}^n, C_{Lat}(\mathbb{R}^n), \hat{\mathbb{F}}_X[\cdot])$ forms a nonlinear expectation space. $\hat{\mathbb{F}}_X$ is called the distribution of X . If $\hat{\mathbb{E}}$ is sublinear, then $\hat{\mathbb{F}}_X$ is also sublinear. Moreover, $\hat{\mathbb{F}}_X$ has the following representation: there exists a family of probability measures $\{F_X(\theta, \cdot)\}_{\theta \in \Theta}$ on $(\mathbb{R}^n, \mathcal{B}(\mathbb{R}^n))$ such that

$$\hat{\mathbb{F}}_X[\varphi] = \sup_{\theta \in \Theta} \int_{\mathbb{R}^n} \varphi(x) F_X(\theta, dx), \quad \text{for each bounded continuous function } \varphi.$$

Thus $\hat{\mathbb{F}}_X$ indeed characterizes the distribution uncertainty of X .

Let X_1 and X_2 be two n -dimensional random vectors defined on nonlinear expectation spaces $(\Omega_1, \mathcal{H}_1, \hat{\mathbb{E}}_1)$ and $(\Omega_2, \mathcal{H}_2, \hat{\mathbb{E}}_2)$, respectively. They are called identically distributed, denoted by $X_1 \stackrel{d}{=} X_2$, if

$$\hat{\mathbb{E}}_1[\varphi(X_1)] = \hat{\mathbb{E}}_2[\varphi(X_2)], \quad \forall \varphi \in C_{Lat}(\mathbb{R}^n).$$

In this case X_1 is also said to be a copy of X_2 . It is clear that $X_1 \stackrel{d}{=} X_2$ if and only if they have the same distribution uncertainty. We say that the distribution of X_1 is stronger than that of X_2 if $\hat{\mathbb{E}}_1[\varphi(X_1)] \geq \hat{\mathbb{E}}_2[\varphi(X_2)]$, for $\varphi \in C_{Lat}(\mathbb{R}^n)$. The meaning is that the distribution uncertainty of X_1 is stronger than that of X_2 .

The distribution of $X \in \mathcal{H}$ has the following two typical parameters: the upper mean $\bar{\mu} := \hat{\mathbb{E}}[X]$ and the lower mean $\underline{\mu} := -\hat{\mathbb{E}}[-X]$. If $\bar{\mu} = \underline{\mu}$ then we say that X has no mean uncertainty.

In a nonlinear expectation space $(\Omega, \mathcal{H}, \hat{\mathbb{E}})$ a random vector $Y = (Y_1, \dots, Y_n)$, $Y_i \in \mathcal{H}$ is said to be independent from another random vector $X =$

(X_1, \dots, X_m) , $X_i \in \mathcal{H}$ under $\hat{\mathbb{E}}[\cdot]$ if for each test function $\varphi \in C_{Lat}(\mathbb{R}^m \times \mathbb{R}^n)$ we have

$$\hat{\mathbb{E}}[\varphi(X, Y)] = \hat{\mathbb{E}}[\hat{\mathbb{E}}[\varphi(x, Y)]_{x=X}].$$

Under a sublinear expectation $\hat{\mathbb{E}}$, the independence of Y from X means that the uncertainty of distributions of Y does not change with each realization of $X = x$, $x \in \mathbb{R}^n$. It is important to note that under nonlinear expectations the condition “ Y is independent from X ” does not imply automatically that “ X is independent from Y ”.

A sequence of d -dimensional random vectors $\{\eta_i\}_{i=1}^\infty$ in a nonlinear expectation space $(\Omega, \mathcal{H}, \hat{\mathbb{E}})$ is said to converge in distribution (or in law) under $\hat{\mathbb{E}}$ if for each $\varphi \in C_b(\mathbb{R}^n)$ the sequence $\{\hat{\mathbb{E}}[\varphi(\eta_i)]\}_{i=1}^\infty$ converges, where $C_b(\mathbb{R}^n)$ denotes the space of all bounded and continuous functions on \mathbb{R}^n . In this case it is easy to check that the functional defined by

$$\hat{\mathbb{F}}[\varphi] := \lim_{i \rightarrow \infty} \hat{\mathbb{E}}[\varphi(\eta_i)], \quad \varphi \in C_b(\mathbb{R}^n)$$

forms a nonlinear expectation on $(\mathbb{R}^n, C_b(\mathbb{R}^n))$. If $\hat{\mathbb{E}}$ is a sublinear (resp. linear) expectation, then $\hat{\mathbb{F}}$ is also sublinear (resp. linear).

2.3. Normal distributions under a sublinear expectation.

We begin by defining a special type of distribution, which plays the same role as the well-known normal distribution in classical probability theory and statistics. Recall the well-known classical characterization: X is a zero mean normal distribution, i.e., $X \stackrel{d}{=} N(0, \Sigma)$ if and only if

$$aX + bX' \stackrel{d}{=} \sqrt{a^2 + b^2}X, \quad \text{for } a, b \geq 0,$$

where X' is an independent copy of X . The covariance matrix Σ is defined by $\Sigma = E[XX^*]$.

We now consider the so-called G -normal distribution under a sublinear expectation space. A d -dimensional random vector $X = (X_1, \dots, X_d)$ in a sublinear expectation space $(\Omega, \mathcal{H}, \hat{\mathbb{E}})$ is called **G -normally distributed** with zero mean if for each $a, b \geq 0$ we have

$$aX + b\bar{X} \stackrel{d}{=} \sqrt{a^2 + b^2}X, \quad \text{for } a, b \geq 0, \tag{2.1}$$

where \bar{X} is an independent copy of X .

It is easy to check that, if X satisfies (2.1), then any linear combination of X also satisfies (2.1). From $\hat{\mathbb{E}}[X_i + \bar{X}_i] = 2\hat{\mathbb{E}}[X_i]$ and $\hat{\mathbb{E}}[X_i + \bar{X}_i] = \hat{\mathbb{E}}[\sqrt{2}X_i] = \sqrt{2}\hat{\mathbb{E}}[X_i]$ we have $\hat{\mathbb{E}}[X_i] = 0$, and similarly, $\hat{\mathbb{E}}[-X_i] = 0$ for $i = 1, \dots, d$.

We denote by $\mathbb{S}(d)$ the linear space of all $d \times d$ symmetric matrices and by $\mathbb{S}_+(d)$ all non-negative elements in $\mathbb{S}(d)$. We will see that the distribution of X is characterized by a sublinear function $G : \mathbb{S}(d) \mapsto \mathbb{R}$ defined by

$$G(A) = G_X(A) := \frac{1}{2}\hat{\mathbb{E}}[\langle AX, X \rangle], \quad A \in \mathbb{S}(d). \tag{2.2}$$

It is easy to check that G is a sublinear and monotone function on $\mathbb{S}(d)$. Thus there exists a bounded and closed subset Θ in $\mathbb{S}_+(d)$ such that (see e.g. Peng (2010a))

$$\frac{1}{2}\hat{\mathbb{E}}[\langle AX, X \rangle] = \hat{G}(A) = \frac{1}{2} \max_{Q \in \Theta} \text{tr}[AQ], \quad A \in \mathbb{S}(d). \quad (2.3)$$

If Θ is a singleton: $\Theta = \{Q\}$, then X is normally distributed in the classical sense, with mean zero and covariance Q . In general Θ characterizes the covariance uncertainty of X . We denote $X \stackrel{d}{=} N(\{0\} \times \Theta)$.

A d -dimensional random vector $Y = (Y_1, \dots, Y_d)$ in a sublinear expectation space $(\Omega, \mathcal{H}, \hat{\mathbb{E}})$ is called **maximally distributed** if we have

$$a^2Y + b^2\bar{Y} \stackrel{d}{=} (a^2 + b^2)Y, \quad \forall a, b \in \mathbb{R}, \quad (2.4)$$

where \bar{Y} is an independent copy of Y . A maximally distributed Y is characterized by a sublinear function $g = g_Y(p) : \mathbb{R}^d \mapsto \mathbb{R}$ defined by

$$g_Y(p) := \hat{\mathbb{E}}[\langle p, Y \rangle], \quad p \in \mathbb{R}^d. \quad (2.5)$$

It is easy to check that g is a sublinear function on \mathbb{R}^d . Thus, as for (2.3), there exists a bounded closed and convex subset $\bar{\Theta} \in \mathbb{R}^d$ such that

$$g(p) = \sup_{q \in \bar{\Theta}} \langle p, q \rangle, \quad p \in \mathbb{R}^d. \quad (2.6)$$

It can be proved that the maximal distribution of Y is given by

$$\hat{\mathbb{F}}_Y[\varphi] = \hat{\mathbb{E}}[\varphi(Y)] = \max_{v \in \bar{\Theta}} \varphi(v), \quad \varphi \in C_{Lat}(\mathbb{R}^d).$$

We denote $Y \stackrel{d}{=} N(\bar{\Theta} \times \{0\})$.

The above two types of distributions can be nontrivially combined together to form a new distribution. We consider a pair of random vectors $(X, Y) \in \mathcal{H}^{2d}$ where X is G -normally distributed and Y is maximally distributed.

In general, a pair of d -dimensional random vectors (X, Y) in a sublinear expectation space $(\Omega, \mathcal{H}, \hat{\mathbb{E}})$ is called G -distributed if for each $a, b \geq 0$ we have

$$(aX + b\bar{X}, a^2Y + b^2\bar{Y}) \stackrel{d}{=} (\sqrt{a^2 + b^2}X, (a^2 + b^2)Y), \quad \forall a, b \geq 0, \quad (2.7)$$

where (\bar{X}, \bar{Y}) is an independent copy of (X, Y) .

The distribution of (X, Y) can be characterized by the following function:

$$G(p, A) := \hat{\mathbb{E}} \left[\frac{1}{2} \langle AX, X \rangle + \langle p, Y \rangle \right], \quad (p, A) \in \mathbb{R}^d \times \mathbb{S}(d). \quad (2.8)$$

It is easy to check that $G : \mathbb{R}^d \times \mathbb{S}(d) \mapsto \mathbb{R}$ is a sublinear function which is monotone in $A \in \mathbb{S}(d)$. Clearly G is also a continuous function. Therefore there exists a bounded and closed subset $\Gamma \subset \mathbb{R}^d \times \mathbb{S}_+(d)$ such that

$$G(p, A) = \sup_{(q, Q) \in \Gamma} \left[\frac{1}{2} \text{tr}[AQ] + \langle p, q \rangle \right], \quad \forall (p, A) \in \mathbb{R}^d \times \mathbb{S}(d). \quad (2.9)$$

The following result tells us that for each such type of function G , there exists a unique G -normal distribution.

Proposition 2.3. (Peng (2008b, Proposition 4.2)) *Let $G : \mathbb{R}^d \times \mathbb{S}(d) \mapsto \mathbb{R}$ be a given sublinear function which is monotone in $A \in \mathbb{S}(d)$, i.e., G has the form of (2.9). Then there exists a pair of d -dimensional random vectors (X, Y) in some sublinear expectation space $(\Omega, \mathcal{H}, \hat{\mathbb{E}})$ satisfying (2.7) and (2.8). The distribution of (X, Y) is uniquely determined by the function G . Moreover the function u defined by*

$$u(t, x, y) := \hat{\mathbb{E}}[\varphi(x + \sqrt{t}X, y + tY)], \quad (t, x, y) \in [0, \infty) \times \mathbb{R}^d \times \mathbb{R}^d, \quad (2.10)$$

for each given $\varphi \in C_{Lat}(\mathbb{R}^{2d})$, is the unique (viscosity) solution of the parabolic PDE

$$\partial_t u - G(D_y u, D_x^2 u) = 0, \quad u|_{t=0} = \varphi, \quad (2.11)$$

where $D_y = (\partial_{y_i})_{i=1}^d$, $D_x^2 = (\partial_{x_i x_j}^2)_{i,j=1}^d$.

In general, to describe a possibly degenerate PDE of type (2.11), one needs the notion of viscosity solutions. But readers also can only consider non-degenerate situations (under strong elliptic condition). Under such condition, equation (2.11) has a unique smooth solution $u \in C^{1+\frac{\alpha}{2}, 2+\alpha}((0, \infty) \times \mathbb{R}^d)$ (see Krylov (1987) and Wang (1992)). The notion of viscosity solution was introduced by Crandall and Lions. For the existence and uniqueness of solutions and related very rich references we refer to a systematic guide of Crandall, Ishii and Lions (1992) (see also the Appendix of Peng (2007b, 2010a) for more specific parabolic cases). In the case where $d = 1$ and G contains only the second order derivative $D_x^2 u$, the G -heat equation is the well-known Baronblatt equation (see Avellanaeda, Levy and Paras (1995)).

If both (X, Y) and (\bar{X}, \bar{Y}) are G -normal distributed with the same G , i.e.,

$$G(p, A) := \hat{\mathbb{E}} \left[\frac{1}{2} \langle AX, X \rangle + \langle p, Y \rangle \right] = \hat{\mathbb{E}} \left[\frac{1}{2} \langle A\bar{X}, \bar{X} \rangle + \langle p, \bar{Y} \rangle \right], \\ \forall (p, A) \in \mathbb{S}(d) \times \mathbb{R}^d,$$

then $(X, Y) \stackrel{d}{=} (\bar{X}, \bar{Y})$. In particular, $X \stackrel{d}{=} -X$.

Let (X, Y) be G -normally distributed. For each $\psi \in C_{Lat}(\mathbb{R}^d)$ we define a function

$$v(t, x) := \hat{\mathbb{E}}[\psi(x + \sqrt{t}X + tY)], \quad (t, x) \in [0, \infty) \times \mathbb{R}^d.$$

Then v is the unique solution of the following parabolic PDE

$$\partial_t v - G(D_x v, D_x^2 v) = 0, \quad v|_{t=0} = \psi. \quad (2.12)$$

Moreover we have $v(t, x + y) \equiv u(t, x, y)$, where u is the solution of the PDE (2.11) with initial condition $u(t, x, y)|_{t=0} = \psi(x + y)$.

2.4. Central limit theorem and law of large numbers. We have a generalized central limit theorem together with the law of large numbers:

Theorem 2.4. (Central Limit Theorem, Peng (2007a, 2010a)) Let $\{(X_i, Y_i)\}_{i=1}^\infty$ be a sequence of $\mathbb{R}^d \times \mathbb{R}^d$ -valued random variables in $(\mathcal{H}, \hat{\mathbb{E}})$. We assume that $(X_{i+1}, Y_{i+1}) \stackrel{d}{=} (X_i, Y_i)$ and (X_{i+1}, Y_{i+1}) is independent from $\{(X_1, Y_1), \dots, (X_i, Y_i)\}$ for each $i = 1, 2, \dots$. We further assume that $\hat{\mathbb{E}}[X_1] = \hat{\mathbb{E}}[-X_1] = 0$ and $\hat{\mathbb{E}}[|X_1|^{2+\delta}] + \hat{\mathbb{E}}[|Y_1|^{1+\delta}] < \infty$ for some fixed $\delta > 0$. Then the sequence $\{\bar{S}_n\}_{n=1}^\infty$ defined by $\bar{S}_n := \sum_{i=1}^n (\frac{X_i}{\sqrt{n}} + \frac{Y_i}{n})$ converges in law to $\xi + \zeta$:

$$\lim_{n \rightarrow \infty} \hat{\mathbb{E}}[\varphi(\bar{S}_n)] = \hat{\mathbb{E}}[\varphi(\xi + \zeta)], \quad (2.13)$$

for all functions $\varphi \in C(\mathbb{R}^d)$ satisfying a linear growth condition, where (ξ, ζ) is a pair of G -normal distributed random vectors and where the sublinear function $G : \mathbb{S}(d) \times \mathbb{R}^d \mapsto \mathbb{R}$ is defined by

$$G(p, A) := \hat{\mathbb{E}} \left[\langle p, Y_1 \rangle + \frac{1}{2} \langle AX_1, X_1 \rangle \right], \quad A \in \mathbb{S}(d), \quad p \in \mathbb{R}^d.$$

The proof of this theorem given in Peng (2010) is very different from the classical one. It based on a deep $C^{1,2}$ -estimate of solutions of fully nonlinear parabolic PDEs initially given by Krylov (1987) (see also Wang (1992)). Peng (2010b) then introduced another proof, involving a nonlinear version of weak compactness based on a nonlinear version of tightness.

Corollary 2.5. The sum $\sum_{i=1}^n \frac{X_i}{\sqrt{n}}$ converges in law to $N(\{0\} \times \hat{\Theta})$, where the subset $\hat{\Theta} \subset \mathbb{S}_+(d)$ is defined in (2.3) for $\hat{G}(A) = G(0, A)$, $A \in \mathbb{S}(d)$. The sum $\sum_{i=1}^n \frac{Y_i}{n}$ converges in law to $N(\bar{\Theta} \times \{0\})$, where the subset $\bar{\Theta} \subset \mathbb{R}^d$ is defined in (2.6) for $\bar{G}(p) = G(p, 0)$, $p \in \mathbb{R}^d$. If we take, in particular, $\varphi(y) = d_{\bar{\Theta}}(y) = \inf\{|x-y| : x \in \bar{\Theta}\}$, then we have the following generalized law of large numbers:

$$\lim_{n \rightarrow \infty} \hat{\mathbb{E}} \left[d_{\bar{\Theta}} \left(\sum_{i=1}^n \frac{Y_i}{n} \right) \right] = \sup_{\theta \in \bar{\Theta}} d_{\bar{\Theta}}(\theta) = 0. \quad (2.14)$$

If Y_i has no mean-uncertainty, or in other words, $\bar{\Theta}$ is a singleton: $\bar{\Theta} = \{\bar{\theta}\}$ then (2.14) becomes $\lim_{n \rightarrow \infty} \hat{\mathbb{E}}[|\sum_{i=1}^n \frac{Y_i}{n} - \bar{\theta}|] = 0$. To our knowledge, the law of large numbers with non-additive probability measures have been investigated under a framework and approach quite different from ours, where no convergence in law is obtained (see Marinacci (1999) and Maccheroni & Marinacci (2005)). For a strong version of LLN under our new framework of independence, see Chen (2010).

2.5. Sample based sublinear expectations. One may feel that the notion of the distribution of a d -dimensional random variable X introduced through $\hat{\mathbb{E}}[\varphi(X)]$ is somewhat abstract and complicated. But in practice this

maybe the simplest way for applications: in many cases what we want to get from the distribution of X is basically the expectation of $\varphi(X)$. Here φ can be a financial contract, e.g., a call option $\varphi(x) = \max\{0, x - k\}$, a consumer's utility function, a cost function in optimal control problems, etc. In a classical probability space (Ω, \mathcal{F}, P) , we can use the classical LLN to calculate $E[\varphi(X)]$, by using

$$E[\varphi(X)] = \lim_{n \rightarrow \infty} \frac{1}{n} \sum_{i=1}^n \varphi(x_i),$$

where $x_i, i = 1, 2, \dots$ is an i.i.d. sample from the random variable X . This means that in practice we can use the mean operator

$$\mathbb{M}[\varphi(X)] := \lim_{n \rightarrow \infty} \frac{1}{n} \sum_{i=1}^n \varphi(x_i) : C_{Lat}(\mathbb{R}^d) \mapsto \mathbb{R}$$

to obtain the distribution of X . This defines what we call “sample distribution of X ”. In fact the well-known Monté-Carlo approach is based on this convergence.

We are interested in the corresponding situation in a sublinear expectation space $(\Omega, \mathcal{H}, \hat{\mathbb{E}})$. Let $x_i, i = 1, 2, \dots$ be an i.i.d. sample from X , meaning that $x_i \stackrel{d}{=} X$ and x_{i+1} is independent from x_1, \dots, x_i under $\hat{\mathbb{E}}$. Under this much weaker assumption we have that $\frac{1}{n} \sum_{i=1}^n \varphi(x_i)$ converges in law to a maximal distribution $N([\underline{\mu}, \bar{\mu}] \times \{0\})$, with $\bar{\mu} = \hat{\mathbb{E}}[\varphi(X)]$ and $\underline{\mu} = -\hat{\mathbb{E}}[-\varphi(X)]$. A direct meaning of this result is that, when $n \rightarrow \infty$, the number $\frac{1}{n} \sum_{i=1}^n \varphi(x_i)$ can take any value inside $[\underline{\mu}, \bar{\mu}]$. Then we can calculate $\hat{\mathbb{E}}[\varphi(X)]$ by introducing the following upper limit mean operator of $\{\varphi(x_i)\}_{i=1}^\infty$:

$$\hat{\mathbb{M}}_{\{x_i\}}[\varphi] := \limsup_{n \rightarrow \infty} \frac{1}{n} \sum_{i=1}^n \varphi(x_i), \quad \varphi \in C_{b.Lat}(\mathbb{R}^d).$$

On the other hand, it is easy to check that for any arbitrarily given sequence of data $\{x_i\}_{i=1}^\infty$, the above defined $\hat{\mathbb{M}}_{\{x_i\}}[\varphi]$ still forms a sublinear expectation on $(\mathbb{R}^d, C_{b.Lat}(\mathbb{R}))$. We call $\hat{\mathbb{M}}_{\{x_i\}}$ the sublinear distribution of the data $\{x_i\}_{i=1}^\infty$. $\hat{\mathbb{M}}_{\{x_i\}}$ gives us the statistics and statistical uncertainty of the random data $\{x_i\}_{i=1}^\infty$. This also provides a new “nonlinear Monté-Carlo” approach (see Peng (2009)).

In the case where $\hat{\mathbb{M}}_{\{x_i\}}[\varphi] < \infty$ for $\varphi(x) \equiv |x|$, we can prove that $\hat{\mathbb{M}}_{\{x_i\}}[\varphi]$ is also well-defined for $\varphi \in \mathbb{L}^\infty(\mathbb{R}^d)$. This allows us to calculate the capacity $\hat{c}(B) := \hat{\mathbb{M}}_{\{x_i\}}[\mathbf{1}_B]$, $B \in \mathcal{B}(\mathbb{R}^d)$, of $\{x_i\}_{i=1}^\infty$ which is the “upper relative frequency” of $\{x_i\}_{i=1}^\infty$ in B .

For a sample with relatively finite size $\{x_i\}_{i=1}^N$, we can also introduce the following form of sublinear expectation:

$$\hat{\mathbb{F}}[\varphi] := \sup_{\theta \in \Theta} \sum_{i=1}^N p_i(\theta) \varphi(x_i), \quad \text{with } p_i(\theta) \geq 0, \sum_{i=1}^N p_i(\theta) = 1.$$

Here $\{(p_i(\theta))_{i=1}^N : \theta \in \Theta\}$ is regarded as the subset of distribution uncertainty. Conversely, from the representation theorem of sublinear expectation, each sublinear expectation based on a sample $\{x_i\}_{i=1}^N$ also has the above representation.

In many cases we are concerned with some \mathbb{R}^d -valued continuous time data $(x_t)_{t \geq 0}$. It's upper mean expectation can be defined by

$$\hat{\mathbb{M}}_{(x_t)}[\varphi] = \limsup_{T \rightarrow \infty} \frac{1}{T} \int_0^T \varphi(x_t) dt, \quad \varphi \in C_{Lat}(\mathbb{R}^d),$$

or, in some circumstances,

$$\hat{\mathbb{M}}_{(x_t)}[\varphi] = \limsup_{T \rightarrow \infty} \int_0^T \varphi(x_t) \mu_T(dt),$$

where, for each $T > 0$, $\mu_T(\cdot)$ is a given non-negative measure on $([0, T], \mathcal{B}([0, T]))$ with $\mu_T([0, T]) = 1$. $\hat{\mathbb{M}}_{(x_t)}$ also forms a sublinear expectations on $(\mathbb{R}^d, \mathcal{B}(\mathbb{R}^d))$. This notion also links many other research domains such as dynamical systems, particle systems.

3. G -Brownian Motion and its Stochastic Calculus

3.1. Brownian motion under a sublinear expectation. In this section we discuss G -Brownian motion under a nonlinear expectation, called G -expectation which is a natural generalization of g -expectation to a fully nonlinear case, i.e., the martingale under G -expectation is in fact a path-dependence solution of fully nonlinear PDE, whereas g -martingale corresponds to a quasi-linear one. G -martingale is very useful to measure the risk of path-dependent financial products.

We introduce the notion of Brownian motion related to the G -normal distribution in a space of a sublinear expectation. We first give the definition of the G -Brownian motion introduced in Peng (2006a). For simplification we only consider 1-dimensional G -Brownian motion. Multidimensional case can be found in Peng (2008a, 2010a).

Definition 3.1. A process $\{B_t(\omega)\}_{t \geq 0}$ in a sublinear expectation space $(\Omega, \mathcal{H}, \hat{\mathbb{E}})$ is called a **Brownian motion** under $\hat{\mathbb{E}}$ if for each $n \in \mathbb{N}$ and $0 \leq t_1, \dots, t_n < \infty$, $B_{t_1}, \dots, B_{t_n} \in \mathcal{H}$ and the following properties are satisfied:

- (i) $B_0(\omega) = 0$,
- (ii) For each $t, s \geq 0$, the increments satisfy $B_{t+s} - B_t \stackrel{d}{=} B_s$ and $B_{t+s} - B_t$ is independent from $(B_{t_1}, B_{t_2}, \dots, B_{t_n})$, for each $0 \leq t_1 \leq \dots \leq t_n \leq t$.
- (iii) $|B_t|^3 \in \mathcal{H}$ and $\hat{\mathbb{E}}[|B_t|^3]/t \rightarrow 0$ as $t \downarrow 0$.

B is called a symmetric Brownian motion if $\hat{\mathbb{E}}[B_t] = -\hat{\mathbb{E}}[-B_t] = 0$. If moreover, there exists a nonlinear expectation $\tilde{\mathbb{E}}$ defined on (Ω, \mathcal{H}) dominated by $\hat{\mathbb{E}}$, namely,

$$\tilde{\mathbb{E}}[X] - \tilde{\mathbb{E}}[Y] \leq \hat{\mathbb{E}}[X - Y], \quad X, Y \in \mathcal{H}$$

and such that the above condition (ii) also holds for $\tilde{\mathbb{E}}$, then B is also called a Brownian motion under $\tilde{\mathbb{E}}$.

Condition (iii) is to ensure that B has continuous trajectories. Without this condition, B may become a G -Lévy process (see Hu and Peng (2009b)).

Theorem 3.2. *Let $(B_t)_{t \geq 0}$ be a symmetric G -Brownian motion defined on a sublinear expectation space $(\Omega, \mathcal{H}, \hat{\mathbb{E}})$. Then $B_t/\sqrt{t} \stackrel{d}{=} N(0, [\underline{\sigma}^2, \bar{\sigma}^2])$ with $\bar{\sigma}^2 = \hat{\mathbb{E}}[\tilde{B}_1^2]$ and $\underline{\sigma}^2 = -\hat{\mathbb{E}}[-\tilde{B}_1^2]$. Moreover, if $\underline{\sigma}^2 = \bar{\sigma}^2 > 0$, then the finite dimensional distribution of $(B_t/\bar{\sigma})_{t \geq 0}$ coincides with that of classical one dimensional standard Brownian motion.*

A Brownian motion under a sublinear expectation space is often called a G -Brownian motion. Here the letter G indicates that the B_t is G -normal distributed with

$$G(\alpha) := \frac{1}{2} \hat{\mathbb{E}}[\alpha B_1^2], \quad \alpha \in \mathbb{R}.$$

We can prove that, for each $\lambda > 0$ and $t_0 > 0$, both $(\lambda^{-\frac{1}{2}} B_{\lambda t})_{t \geq 0}$ and $(B_{t+t_0} - B_{t_0})_{t \geq 0}$ are symmetric G -Brownian motions with the same generating function G . That is, a G -Brownian motion enjoys the same type of scaling as in the classical situation.

3.2. Construction of a G -Brownian motion. Since each increment of a G -Brownian motion B is G -normal distributed, a natural way to construct this process is to follow Kolmogorov’s method: first, establish the finite dimensional (sublinear) distribution of B and then take a completion. The completion will be in the next subsection.

We briefly explain how to construct a symmetric G -Brownian. More details were given in Peng (2006a, 2010a). Just as at the beginning of this paper, we denote by $\Omega = C([0, \infty))$ the space of all real-valued continuous paths $(\omega_t)_{t \in \mathbb{R}^+}$ with $\omega_0 = 0$, by $L^0(\Omega)$ the space of all $\mathcal{B}(\Omega)$ -measurable functions and by $C_b(\Omega)$ all bounded and continuous functions on Ω . For each fixed $T \geq 0$, we consider the following space of random variables:

$$\mathcal{H}_T = C_{Lat}(\Omega_T) := \{X(\omega) = \varphi(\omega_{t_1 \wedge T}, \dots, \omega_{t_m \wedge T}), \forall m \geq 1, \varphi \in C_{l.Lat}(\mathbb{R}^m)\},$$

where $C_{l.Lat}(\mathbb{R}^m)$ is the smallest lattice on \mathbb{R}^m containing $C_{Lat}(\mathbb{R}^m)$ and all polynomials of $x \in \mathbb{R}^m$. It is clear that $C_{Lat}(\Omega_t) \subseteq C_{Lat}(\Omega_T)$, for $t \leq T$. We also denote

$$\mathcal{H} = C_{Lat}(\Omega) := \bigcup_{t \geq 0} C_{Lat}(\Omega_t).$$

We will consider the canonical space and set $B_t(\omega) = \omega_t$, $t \in [0, \infty)$, for $\omega \in \Omega$. Then it remains to introduce a sublinear expectation $\hat{\mathbb{E}}$ on (Ω, \mathcal{H}) such that B is a G -Brownian motion, for a given sublinear function $G(a) = \frac{1}{2}(\underline{\sigma}^2 a^+ - \bar{\sigma}^2 a^-)$, $a \in \mathbb{R}$. Let $\{\xi_i\}_{i=1}^\infty$ be a sequence of G -normal distributed random variables in some sublinear expectation space $(\bar{\Omega}, \bar{\mathcal{H}}, \bar{\mathbb{E}})$: such that $\xi_i \stackrel{d}{=} N(\{0\} \times [\underline{\sigma}^2, \bar{\sigma}^2])$ and such that ξ_{i+1} is independent from (ξ_1, \dots, ξ_i) for each $i = 1, 2, \dots$. For each $X \in \mathcal{H}$ of the form

$$X = \varphi(B_{t_1} - B_{t_0}, B_{t_2} - B_{t_1}, \dots, B_{t_m} - B_{t_{m-1}})$$

for some $\varphi \in C_{l.Lat}(\mathbb{R}^m)$ and $0 = t_0 < t_1 < \dots < t_m < \infty$, we set

$$\hat{\mathbb{E}}[X] = \bar{\mathbb{E}}[\varphi(\sqrt{t_1 - t_0}\xi_1, \dots, \sqrt{t_m - t_{m-1}}\xi_m)],$$

and

$$\begin{aligned} \hat{\mathbb{E}}_{t_k}[X] &= \Phi(B_{t_1}, \dots, B_{t_k} - B_{t_{k-1}}), \quad \text{where} \\ \Phi(x_1, \dots, x_k) &= \bar{\mathbb{E}}[\varphi(x_1, \dots, x_k, \sqrt{t_{k+1} - t_k}\xi_{k+1}, \dots, \sqrt{t_m - t_{m-1}}\xi_m)]. \end{aligned}$$

It is easy to check that $\hat{\mathbb{E}} : \mathcal{H} \mapsto \mathbb{R}$ consistently defines a sublinear expectation on (Ω, \mathcal{H}) and $(B_t)_{t \geq 0}$ is a (symmetric) G -Brownian motion in $(\Omega, \mathcal{H}, \hat{\mathbb{E}})$. In this way we have also defined the conditional expectations $\hat{\mathbb{E}}_t : \mathcal{H} \mapsto \mathcal{H}_t$, $t \geq 0$, satisfying

- (a') If $X \geq Y$, then $\hat{\mathbb{E}}_t[X] \geq \hat{\mathbb{E}}_t[Y]$.
- (b') $\hat{\mathbb{E}}_t[\eta] = \eta$, for each $t \in [0, \infty)$ and $\eta \in C_{Lat}(\Omega_t)$.
- (c') $\hat{\mathbb{E}}_t[X] + \hat{\mathbb{E}}_t[Y] \leq \hat{\mathbb{E}}_t[X + Y]$.
- (d') $\hat{\mathbb{E}}_t[\eta X] = \eta^+ \hat{\mathbb{E}}_t[X] + \eta^- \hat{\mathbb{E}}_t[-X]$, for each $\eta \in C_{Lat}(\Omega_t)$.

Moreover, we have

$$\hat{\mathbb{E}}_t[\hat{\mathbb{E}}_s[X]] = \hat{\mathbb{E}}_{t \wedge s}[X], \quad \text{in particular} \quad \hat{\mathbb{E}}[\hat{\mathbb{E}}_t[X]] = \hat{\mathbb{E}}[X].$$

3.3. G -Brownian motion in a complete sublinear expectation space. Our construction of a G -Brownian motion is very simple. But to obtain the corresponding Itô's calculus we need a completion of the space \mathcal{H} under a natural Banach norm. Indeed, for each $p \geq 1$, $\|X\|_p := \hat{\mathbb{E}}[|X|^p]^{\frac{1}{p}}$, $X \in C_{Lat}(\Omega_T)$ (respectively, $C_{Lat}(\Omega)$) forms a norm under which $C_{Lat}(\Omega_T)$ (resp. $C_{Lat}(\Omega)$) can be continuously extended to a Banach space, denoted by

$$\mathcal{H}_T = L_G^p(\Omega_T) \quad (\text{resp. } \mathcal{H} = L_G^p(\Omega)).$$

For each $0 \leq t \leq T < \infty$ we have $L_G^p(\Omega_t) \subseteq L_G^p(\Omega_T) \subset L_G^p(\Omega)$. It is easy to check that, in $L_G^p(\Omega_T)$ (respectively, $L_G^p(\Omega)$), the extension of $\hat{\mathbb{E}}[\cdot]$ and its

conditional expectations $\hat{\mathbb{E}}_t[\cdot]$ are still sublinear expectation and conditional expectations on $(\Omega, L_G^p(\Omega))$. For each $t \geq 0$, $\hat{\mathbb{E}}_t[\cdot]$ can also be extended as a continuous mapping $\hat{\mathbb{E}}_t[\cdot] : L_G^1(\Omega) \mapsto L_G^1(\Omega_t)$. It enjoys the same type of properties as $\hat{\mathbb{E}}_t[\cdot]$ defined on \mathcal{H}_t .

There are mainly two approaches to introduce $L_G^p(\Omega)$, one is the above method of finite dimensional nonlinear distributions, introduced in Peng (2005b: for more general nonlinear Markovian case, 2006a: for G -Brownian motion). The second one is to take a super-expectation with respect to the related family of probability measures, see Denis and Martini (2006) (a similar approach was introduced in Peng (2004) to treat more nonlinear Markovian processes). They introduced \hat{c} -quasi surely analysis, which is a very powerful tool. These two approaches were unified in Denis, Hu and Peng (2008), see also Hu and Peng (2009a).

3.4. $L_G^p(\Omega)$ is a subspace of measurable functions on Ω . The following result was established in Denis, Hu and Peng (2008), a simpler and more direct argument was then obtained in Hu and Peng (2009a).

Theorem 3.3. *We have*

- (i) *There exists a family of (σ -additive) probability measures \mathcal{P}_G defined on $(\Omega, \mathcal{B}(\Omega))$, which is weakly relatively compact, P and Q are mutually singular from each other for each different $P, Q \in \mathcal{P}_G$ and such that*

$$\hat{\mathbb{E}}[X] = \sup_{P \in \mathcal{P}_G} E_P[X] = \sup_{P \in \mathcal{P}_G} \int_{\Omega} X(\omega) dP, \text{ for each } X \in C_{Lat}(\Omega).$$

Let \hat{c} be the Choquet capacity induced by

$$\hat{c}(A) = \hat{\mathbb{E}}[\mathbf{1}_A] = \sup_{P \in \mathcal{P}_G} E_P[\mathbf{1}_A], \text{ for } A \in \mathcal{B}(\Omega).$$

- (ii) *Let $C_b(\Omega)$ be the space of all bounded and continuous functions on Ω ; $L^0(\Omega)$ be the space of all $\mathcal{B}(\Omega)$ -measurable functions and let*

$$\mathbb{L}^p(\Omega) := \left\{ X \in L^0(\Omega) : \sup_{P \in \mathcal{P}_G} E_P[|X|^p] < \infty \right\}, \quad p \geq 1.$$

Then every element $X \in L_G^p(\Omega)$ has a \hat{c} -quasi continuous version, namely, there exists a $Y \in L_G^p(\Omega)$, with $X = Y$, quasi-surely such that, for each $\varepsilon > 0$, there is an open set $O \subset \Omega$ with $\hat{c}(O) < \varepsilon$ such that $Y|_{O^c}$ is continuous. We also have $\mathbb{L}^p(\Omega) \supset L_G^p(\Omega) \supset C_b(\Omega)$. Moreover,

$$L_G^p(\Omega) = \{X \in \mathbb{L}^p(\Omega) : X \text{ has a } \hat{c}\text{-quasi-continuous version and } \lim_{n \rightarrow \infty} \hat{\mathbb{E}}[|X|^p \mathbf{1}_{\{|X|>n\}}] = 0\}.$$

3.5. Itô integral of G -Brownian motion. Itô integral with respect to a G -Brownian motion is defined in an analogous way as the classical one, but in a language of “ $\hat{\mathbb{C}}$ -quasi-surely”, or in other words, under L_G^2 -norm. The following definition of Itô integral is from Peng (2006a). Denis and Martini (2006) independently defined this integral in the same space. For each $T > 0$, a partition Δ of $[0, T]$ is a finite ordered subset $\Delta = \{t_1, \dots, t_N\}$ such that $0 = t_0 < t_1 < \dots < t_N = T$. Let $p \geq 1$ be fixed. We consider the following type of simple processes: For a given partition $\{t_0, \dots, t_N\} = \Delta$ of $[0, T]$, we set

$$\eta_t(\omega) = \sum_{j=0}^{N-1} \xi_j(\omega) \mathbf{I}_{[t_j, t_{j+1})}(t),$$

where $\xi_i \in L_G^p(\Omega_{t_i})$, $i = 0, 1, 2, \dots, N-1$, are given. The collection of processes of this form is denoted by $M_G^{p,0}(0, T)$.

Definition 3.4. For each $p \geq 1$, we denote by $M_G^p(0, T)$ the completion of $M_G^{p,0}(0, T)$ under the norm

$$\|\eta\|_{M_G^p(0, T)} := \left\{ \hat{\mathbb{E}} \left[\int_0^T |\eta_t|^p dt \right] \right\}^{1/p}.$$

Following Itô, for each $\eta \in M_G^{2,0}(0, T)$ with the above form, we define its Itô integral by

$$I(\eta) = \int_0^T \eta(s) dB_s := \sum_{j=0}^{N-1} \xi_j (B_{t_{j+1}} - B_{t_j}).$$

It is easy to check that $I : M_G^{2,0}(0, T) \mapsto L_G^2(\Omega_T)$ is a linear continuous mapping and thus can be continuously extended to $I : M_G^2(0, T) \mapsto L_G^2(\Omega_T)$. Moreover, this extension of I satisfies

$$\hat{\mathbb{E}}[I] = 0 \text{ and } \hat{\mathbb{E}}[I^2] \leq \bar{\sigma}^2 \hat{\mathbb{E}} \left[\int_0^T (\eta(t))^2 dt \right], \quad \eta \in M_G^2(0, T).$$

Therefore we can define, for a fixed $\eta \in M_G^2(0, T)$, the stochastic integral

$$\int_0^T \eta(s) dB_s := I(\eta).$$

We list some main properties of the Itô integral of G -Brownian motion. We denote for some $0 \leq s \leq t \leq T$,

$$\int_s^t \eta_u dB_u := \int_0^T \mathbf{I}_{[s, t]}(u) \eta_u dB_u.$$

We have

Proposition 3.5. *Let $\eta, \theta \in M_G^2(0, T)$ and $0 \leq s \leq r \leq t \leq T$. Then we have*

- (i) $\int_s^t \eta_u dB_u = \int_s^r \eta_u dB_u + \int_r^t \eta_u dB_u,$
- (ii) $\int_s^t (\alpha \eta_u + \theta_u) dB_u = \alpha \int_s^t \eta_u dB_u + \int_s^t \theta_u dB_u,$ if α is bounded and in $L_G^1(\Omega_s),$
- (iii) $\hat{\mathbb{E}}_t[X + \int_t^T \eta_u dB_u] = \hat{\mathbb{E}}_t[X], \forall X \in L_G^1(\Omega).$

3.6. Quadratic variation process. The quadratic variation process of a G -Brownian motion is a particularly important process, which is not yet fully understood. But its definition is quite classical: Let $\pi_t^N, N = 1, 2, \dots,$ be a sequence of partitions of $[0, t]$ such that $|\pi_t^N| \rightarrow 0.$ We can easily prove that, in the space $L_G^2(\Omega),$

$$\langle B \rangle_t = \lim_{|\pi_t^N| \rightarrow 0} \sum_{j=0}^{N-1} (B_{t_{j+1}^N} - B_{t_j^N})^2 = B_t^2 - 2 \int_0^t B_s dB_s.$$

From the above construction, $\{\langle B \rangle_t\}_{t \geq 0}$ is an increasing process with $\langle B \rangle_0 = 0.$ We call it the *quadratic variation process* of the G -Brownian motion $B.$ It characterizes the part of statistical uncertainty of G -Brownian motion. It is important to keep in mind that $\langle B \rangle_t$ is not a deterministic process unless $\sigma^2 = \bar{\sigma}^2,$ i.e., when B is a classical Brownian motion.

A very interesting point of the quadratic variation process $\langle B \rangle$ is, just like the G -Brownian motion B itself, the increment $\langle B \rangle_{t+s} - \langle B \rangle_s$ is independent of $\langle B \rangle_{t_1}, \dots, \langle B \rangle_{t_n}$ for all $t_1, \dots, t_n \in [0, s]$ and identically distributed: $\langle B \rangle_{t+s} - \langle B \rangle_s \stackrel{d}{=} \langle B \rangle_t.$ Moreover $\hat{\mathbb{E}}[|\langle B \rangle_t|^3] \leq Ct^3.$ Hence the quadratic variation process $\langle B \rangle$ of the G -Brownian motion is in fact a G -Brownian motion, but for a different generating function $G.$

We have the following isometry:

$$\hat{\mathbb{E}} \left[\left(\int_0^T \eta(s) dB_s \right)^2 \right] = \hat{\mathbb{E}} \left[\int_0^T \eta^2(s) d\langle B \rangle_s \right], \quad \eta \in M_G^2(0, T).$$

Furthermore, the distribution of $\langle B \rangle_t$ is given by $\hat{\mathbb{E}}[\varphi(\langle B \rangle_t)] = \max_{v \in [\underline{\sigma}^2, \bar{\sigma}^2]} \varphi(vt)$ and we can also prove that \hat{c} -quasi-surely, $\underline{\sigma}^2 t \leq \langle B \rangle_{t+s} - \langle B \rangle_s \leq \bar{\sigma}^2 t.$ It follows that

$$\hat{\mathbb{E}}[|\langle B \rangle_{s+t} - \langle B \rangle_s|^2] = \sup_{P \in \mathcal{P}_G} E_P[|\langle B \rangle_{s+t} - \langle B \rangle_s|^2] = \max_{v \in [\underline{\sigma}^2, \bar{\sigma}^2]} |vt|^2 = \bar{\sigma}^4 t^2.$$

We then can apply Kolmogorov’s criteria to prove that $\langle B \rangle_s(\omega)$ \hat{c} -q.s. has continuous paths.

3.7. Itô's formula for G -Brownian motion. We have the corresponding Itô formula of $\Phi(X_t)$ for a " G -Itô process" X . The following form of Itô's formula was obtained by Peng (2006a) and improved by Gao (2009). The following result of Li and Peng (2009) significantly improved the previous ones. We now consider an Itô process

$$X_t^\nu = X_0^\nu + \int_0^t \alpha_s^\nu ds + \int_0^t \eta_s^\nu d\langle B \rangle_s + \int_0^t \beta_s^\nu dB_s.$$

Proposition 3.6. *Let $\alpha^\nu, \eta^\nu \in M_G^1(0, T)$ and $\beta^\nu \in M_G^2(0, T)$, $\nu = 1, \dots, n$. Then for each $t \geq 0$ and each function Φ in $C^{1,2}([0, t] \times \mathbb{R}^n)$ we have*

$$\begin{aligned} \Phi(t, X_t) - \Phi(s, X_s) &= \sum_{\nu=1}^n \int_s^t \partial_{x^\nu} \Phi(u, X_u) \beta_u^\nu dB_u + \int_s^t [\partial_u \Phi(u, X_u) \\ &\quad + \partial_{x^\nu} \Phi(u, X_u) \alpha_u^\nu] du \\ &\quad + \int_s^t \left[\sum_{\nu=1}^n \partial_{x^\nu} \Phi(u, X_u) \eta_u^\nu \right. \\ &\quad \left. + \frac{1}{2} \sum_{\nu, \mu=1}^n \partial_{x^\mu x^\nu}^2 \Phi(u, X_u) \beta_u^\mu \beta_u^\nu \right] d\langle B \rangle_u. \end{aligned}$$

In fact Li and Peng (2009) allows all the involved processes α^ν, η^ν to belong to a larger space $M_\omega^1(0, T)$ and β^ν to $M_\omega^2(0, T)$.

3.8. Stochastic differential equations. We have the existence and uniqueness result for the following SDE:

$$X_t = X_0 + \int_0^t b(X_s) ds + \int_0^t h(X_s) d\langle B \rangle_s + \int_0^t \sigma(X_s) dB_s, \quad t \in [0, T],$$

where the initial condition $X_0 \in \mathbb{R}^n$ is given and $b, h, \sigma : \mathbb{R}^n \mapsto \mathbb{R}^n$ are given Lipschitz functions, i.e., $|\varphi(x) - \varphi(x')| \leq K|x - x'|$, for each $x, x' \in \mathbb{R}^n$, $\varphi = b, h$ and σ , respectively. Here the interval $[0, T]$ can be arbitrarily large. The solution of the SDE is a continuous process $X \in M_G^2(0, T; \mathbb{R}^n)$.

3.9. Brownian motions, martingales under nonlinear expectation. We can also define a non-symmetric G -Brownian under a sublinear or nonlinear expectation space. Let $G(p, A) : \mathbb{R}^d \times \mathbb{S}(d) \mapsto \mathbb{R}$ be a given sublinear function monotone in A , i.e., in the form (2.9). It is proved in Peng (2010, Sec.3.7, 3.8) that there exists an \mathbb{R}^{2d} -valued Brownian motion $(B_t, b_t)_{t \geq 0}$ such that (B_1, b_1) is G -distributed. In this case $\Omega = C([0, \infty), \mathbb{R}^{2d})$, $(B_t(\omega), b_t(\omega))$ is the canonical process, and the completion of the random variable space is $(\Omega, L_G^1(\Omega))$. B is a symmetric Brownian motion and b is non-symmetric. Under

the sublinear expectation $\hat{\mathbb{E}}$, B_t is normal distributed and b_t is maximal distributed. Moreover for each fixed nonlinear function $\tilde{G}(p, A) : \mathbb{R}^d \times \mathbb{S}(d) \mapsto \mathbb{R}$ which is dominated by G in the following sense:

$$\tilde{G}(p, A) - \tilde{G}(p', A') \leq G(p - p', A - A'), \quad p, p' \in \mathbb{R}, \quad A, A' \in \mathbb{S}(d),$$

we can construct a nonlinear expectation $\tilde{\mathbb{E}}$ on $(\Omega, L_G^1(\Omega))$ such that

$$\tilde{\mathbb{E}}[X] - \tilde{\mathbb{E}}[Y] \leq \hat{\mathbb{E}}[X - Y], \quad X, Y \in L_G^1(\Omega)$$

and that the pair $(B_t, b_t)_{t \geq 0}$ is an \mathbb{R}^{2d} -valued Brownian motion under $\tilde{\mathbb{E}}$. We have

$$\tilde{G}(p, A) = \tilde{\mathbb{E}}[\langle b_1, p \rangle + \frac{1}{2} \langle AB_1, B_1 \rangle], \quad p \in \mathbb{R}^d, \quad A \in \mathbb{S}(d).$$

This formula gives us a characterization of the change of expectations (a generalization of the notion of change of measures in probability theory) from one Brownian motion to another one, using different generator G .

Moreover, $\tilde{\mathbb{E}}$ allows conditional expectations $\tilde{\mathbb{E}}_t : L_G^p(\Omega) \mapsto L_G^p(\Omega_t)$ which is still dominated by $\hat{\mathbb{E}}_t$: $\tilde{\mathbb{E}}_t[X] - \tilde{\mathbb{E}}_t[Y] \leq \hat{\mathbb{E}}_t[X - Y]$, for each $t \geq 0$, satisfying:

1. $\tilde{\mathbb{E}}_t[X] \geq \tilde{\mathbb{E}}_t[Y]$, if $X \geq Y$,
2. $\tilde{\mathbb{E}}_t[X + \eta] = \tilde{\mathbb{E}}_t[X] + \eta$, for $\eta \in L_G^p(\Omega_t)$,
3. $\tilde{\mathbb{E}}_t[X] - \tilde{\mathbb{E}}_t[Y] \leq \hat{\mathbb{E}}_t[X - Y]$,
4. $\tilde{\mathbb{E}}_t[\tilde{\mathbb{E}}_s[X]] = \tilde{\mathbb{E}}_{s \wedge t}[X]$, in particular, $\tilde{\mathbb{E}}[\tilde{\mathbb{E}}_s[X]] = \tilde{\mathbb{E}}[X]$.

In particular, the conditional expectation of $\hat{\mathbb{E}}_t : L_G^p(\Omega) \mapsto L_G^p(\Omega_t)$ is still sublinear in the following sense:

5. $\hat{\mathbb{E}}_t[X] - \hat{\mathbb{E}}_t[Y] \leq \hat{\mathbb{E}}_t[X - Y]$,
6. $\hat{\mathbb{E}}_t[\eta X] = \eta^+ \hat{\mathbb{E}}_t[X] + \eta^- \hat{\mathbb{E}}_t[-X]$, η is a bounded element in $L_G^1(\Omega_t)$.

A process $(Y_t)_{t \geq 0}$ is called a \tilde{G} -martingale (respectively, \tilde{G} -supermartingale; \tilde{G} -submartingale) if for each $t \in [0, \infty)$, $M_t \in L_G^1(\Omega_t)$ and for each $s \in [0, t]$, we have

$$\tilde{\mathbb{E}}_s[M_t] = M_s, \quad (\text{respectively, } \leq M_s; \geq M_s).$$

It is clear that for each $X \in L_G^1(\Omega_T)$, $M_t := \tilde{\mathbb{E}}_t[X]$ is a \tilde{G} -martingale. In particular, if $X = \varphi(b_T + B_T)$, for a bounded and continuous real function φ on \mathbb{R}^d , then

$$M_t = \tilde{\mathbb{E}}_t[X] = u(t, b_t + B_t)$$

where u is the unique viscosity solution of the PDE

$$\partial_t u + \tilde{G}(D_x u, D_{xx}^2 u) = 0, \quad t \in (0, T), \quad x \in \mathbb{R}^d,$$

with the terminal condition $u|_{t=T} = \varphi$. We have discussed the relation between BSDEs and PDEs in the last section. Here again we can claim that in general \tilde{G} -martingale can be regarded as a path-dependent solution of the above fully nonlinear PDE. Also a solution of this PDE is a state-dependent \tilde{G} -martingale.

We observe that, even with the language of PDE, the above construction of Brownian motion and the related nonlinear expectation provide a new norm which is useful in the point view of PDE. Indeed, $\|\varphi\|_{L_G^p} := \hat{\mathbb{E}}[|\varphi(B_T)|^p]^{1/p}$ forms an norm for real functions φ on \mathbb{R}^d . This type of norm was proposed in Peng (2005b). In general, a sublinear monotone semigroup (or, nonlinear Markovian semigroup of Nisio's type) $Q_t(\cdot)$ defined on $C_b(\mathbb{R}^n)$ forms a norm $\|\varphi\|_Q = (Q_t(|\varphi|^p))^{1/p}$. A viscosity solution of the form

$$\partial_t u - G(Du, D^2u) = 0,$$

forms a typical example of such a semigroup if $G = G(p, A)$ is a sublinear function which is monotone in A . In this case $\|\varphi\|_Q^p = u(t, 0)$, where u is the solution of the above PDE with initial condition given by $u|_{t=0} = |\varphi|^p$.

Let us give an explanation, for a given $X \in L_G^p(\Omega_T)$, how a \tilde{G} -martingale $(\tilde{\mathbb{E}}_t[X])_{t \in [0, T]}$, rigorously obtained in Peng from (2005a,b) to (2010a), can be regarded as the solution of a new type of "fully nonlinear" BSDE which is also related to a very interesting martingale representation problem. By using a technique given in Peng (2007b, 2010a), it is easy to prove that, for given $Z \in M_G^2(0, T)$ and $p, q \in M_G^1(0, T)$, the process Y defined by

$$Y_t = Y_0 + \int_0^t Z_s dB_s + \int_0^t p_s db_s + \int_0^t q_s d\langle B \rangle_s - \int_0^t \tilde{G}(p_s, 2q_s) ds, \quad t \in [0, T], \quad (3.1)$$

is a \tilde{G} -martingale. The inverse problem is the so-called nonlinear martingale representation problem: to find a suitable subspace \mathcal{M} in $L_G^1(\Omega_T)$ such that $Y_t := \tilde{\mathbb{E}}_t[X]$ has expression (3.1) for each fixed $X \in \mathcal{M}$. This also implies that the quadruple of the processes $(Y, Z, p, q) \in M_G^2(0, T)$ satisfies a new structure of the following BSDE:

$$-dY_t = \tilde{G}(p_t, 2q_t) dt - Z_t dB_t - p_t db_t - q_t d\langle B \rangle_t, \quad Y_T = X. \quad (3.2)$$

For a particular case where $\tilde{G} = G = G(A)$ (thus $b_t \equiv 0$) and G is sublinear, this martingale representation problem was raised in Peng (2007, 2008 and 2010a). In this case the above formulation becomes:

$$-dY_t = 2G(q_t) dt - q_t d\langle B \rangle_t - Z_t dB_t, \quad Y_T = X.$$

Actually, this representation can be only proved under a strong condition where $X \in \mathcal{H}_T$, see Peng (2010a), Hu, Y. and Peng (2010). For a more general $X \in L_G^2(\Omega_T)$ with $\mathbb{E}[X] = -\mathbb{E}[-X]$, Xu and Zhang (2009) proved the following representation: there exists a unique process $Z \in M_G^2(0, T)$ such that $\mathbb{E}_t[X] =$

$\mathbb{E}[X] + \int_0^t Z_s dB_s, t \in [0, T]$. In more general case, we observe that the process $K_t = \int_0^t G(2q_s) ds - \int_0^t q_s d\langle B \rangle_s$ is an increasing process with $K_0 = 0$ such that $-K$ is a G -martingale. Under the assumption $\hat{\mathbb{E}}[\sup_{t \in [0, T]} \mathbb{E}_t[|X|^2]] < \infty$, Soner, Touzi and Zhang (2009) first proved the following result: there exists a unique decomposition (Z, K) such that

$$\mathbb{E}_t[X] = \mathbb{E}[X] + \int_0^t Z_s dB_s - K_t, \quad t \in [0, T].$$

The above assumption was weakened by them to $\mathbb{E}[|X|^2] < \infty$ in their 2010 version and also, independently, by Song (2010) with an even weaker assumption $\mathbb{E}[|X|^\beta] < \infty$, for a given $\beta > 1$, by using a quite different method. Our problem of representation is then reduced to prove $K_t = \int_0^t G(2q_s) ds - \int_0^t q_s d\langle B \rangle_s$. Hu and Peng (2010) introduced an a priori estimate for the unknown process q to get a uniqueness result for q . Soner, Touzi and Zhang (2010) proved the well-posedness of the following type of BSDE, called 2BSDE, or 2nd order BSDE,

$$-dY_t = F(t, Y_t, Z_t)dt - Z_t dB_t - dK_t, \quad Y_T = X.$$

This 2BSDE is in fact quite different from the first paper by Cheridito, Soner, Touzi and Victoir (2007) which was within the framework of classical probability space.

We prefer to call (3.2) a BSDE under nonlinear expectation, (see Peng (2005b)), or a fully nonlinear BSDE, instead of 2BSDE. Indeed, in a typical situation where $\tilde{G} = g(p)$ (thus $B_t \equiv 0, Z_t \equiv 0$), the solution $Y_t = \tilde{\mathbb{E}}_t[X]$ is in fact related to a first order fully nonlinear PDE of the form $\partial_t u - g(Du) = 0$. Generally speaking, with different generators $\tilde{G}, Y_t = \tilde{\mathbb{E}}_t[X]$ gives us ‘path-dependent’ solutions of a very large type of quasi-linear or fully nonlinear parabolic PDEs of the first and second order.

Note that for a given $X \in L^1_G(\Omega_T)$, the \tilde{G} -martingale $Y_t := \tilde{\mathbb{E}}_t[X]$ has solved the part Y of the fully nonlinear BSDE (3.2). Furthermore, we can follow the domination approach introduced in Peng (2005b, Theorem 6.1) to consider the following type of multi-dimensional fully nonlinear BSDE:

$$Y_t^i = \tilde{\mathbb{E}}_t^i \left[X^i + \int_t^T f^i(s, Y_s) ds \right], \quad i = 1, \dots, m, \quad Y = (Y^1, \dots, Y^m), \quad (3.3)$$

where, as for a \tilde{G} -expectation, for each $i = 1, \dots, m, \tilde{\mathbb{E}}^i$ is a \tilde{G}_i -expectation and \tilde{G}_i is a real function on $\mathbb{R}^d \times \mathbb{S}(d)$ dominated by G . Then it can be proved that if $f^i(\cdot, y) \in M^1_G(0, T), y \in \mathbb{R}^d$, and is Lipschitz in y , for each i , then for each given terminal condition $X = (X^1, \dots, X^m) \in L^1_G(\Omega_T, \mathbb{R}^m)$, there exists a unique solution $Y \in M^1_G(0, T, \mathbb{R}^m)$ of BSDE (3.3).

Another problem is for stopping times. It is known that stopping times play a fundamental role in classical stochastic analysis. But up to now it is difficult to apply stopping time techniques in G -expectation space since the stopped

process may not belong to the class of processes which are meaningful in the G -framework. Song (2010b) considered the properties of hitting times for G -martingale and the stopped processes. He proved that the stopped processes for G -martingales are still G -martingales and that the hitting times for symmetric G -martingales with strictly increasing quadratic variation processes are quasi-continuous.

References

- [1] Antonelli, F. (1993) Backward-Forward stochastic differential equations, *Ann. Appl. Probab.* **3**(3) 777–793.
- [2] Artzner, Ph., Delbaen, F., Eber, J.-M. and Heath D. (1999) Coherent Measures of Risk, *Mathematical Finance*, **9**, 203–228.
- [3] Avellaneda, M., Levy, A. and Paras A. (1995). Pricing and hedging derivative securities in markets with uncertain volatilities. *Appl. Math. Finance* **2**, 73–88.
- [4] Bally, V. Matoussi, A. (2001) Weak solutions for SPDE's and backward doubly stochastic differential equations, *J. Theor. Probab.* 14(1) 125–164.
- [5] Barles, G., Buckdahn, R. and Pardoux, E. (1997) BSDE's and integro-partial differential equations, *Stochastics*, **60** 57–83.
- [6] Barrieu, P., Cazanave, N. and El Karoui, N. (2008) Closedness results for BMO semi-martingales and application to quadratic BSDEs, *C. R. Math. Acad. Sci. Paris* **346**(15–16), 881–886.
- [7] Barrieu, P. and El Karoui, N. (2004) Optimal derivatives design under dynamic risk measures, in *Mathematics of Finance*, 13–25, *Contemp. Math.*, **351**, AMS, Providence, RI.
- [8] Bensoussan, A. (1982) *Stochastic Control by Functional Analysis Methods*, North-Holland.
- [9] Bensoussan, A. (1992) *Stochastic Control of Partially Observable Systems*, Cambridge.
- [10] Bismut, J.M. (1973) Conjugate Convex Functions in Optimal Stochastic Control, *J. Math. Anal. Appl.* **44**, 384–404.
- [11] Bismut, J.M. (1975) Growth and optimal intertemporal allocation of risks, *Journal of Economic Theory*, **10**, 239–257.
- [12] Bismut, J.M. (1976) Linear quadratic optimal stochastic control with random coefficients, *SIAM J. Control Optimization*, **14**(3) 419–444.
- [13] Blache, F. (2005) Backward stochastic differential equations on manifolds, *Probab. Theory Relat. Fields* **132**, 391–437.
- [14] Bouchard, B. and Touzi, N. (2004) Discrete-time approximation and Monte-Carlo simulation of backward stochastic differential equations, *Stochastic Processes and their Applications*, **111**(2), 175–206.
- [15] Buckdahn, R. and Ma, J. Stochastic viscosity solutions for nonlinear stochastic partial differential equations. Part I, II *Stoch. Processes*.

- [16] Briand, P. and Hu, Y. (2006) BSDE with quadratic growth and unbounded terminal value, *Probab. Theory Related Fields* 136, 604–618.
- [17] Buckdahn, R., Djehiche, B., Li, J., Peng, S. (2009) Mean-Field Backward Stochastic Differential Equations. A Limit Approach. *Annals of Probability*. 37(4), 1524–1565.
- [18] Buckdahn, R., Engelbert, H.-J., Rascanu, A. (2004) On weak solutions of backward stochastic differential equations, *Theory Probab. Applications*, **49**(1), 70–108.
- [19] Buckdahn, R., Li, J. (2008). Stochastic Differential Games and Viscosity Solutions of Hamilton-Jacobi-Bellman-Isaacs Equations. *SIAM. J. Control. Optim.* **47**(1) 444–475.
- [20] Buckdahn, R., Quincampoix, M. and Rascanu, A. (2000) Viability property for a backward stochastic differential equation and applications to partial differential equations, *Probab Theory Rel. Fields* **116**(4), 485–504.
- [21] Carmona, R., Ludkovski, M. (2008) Pricing asset scheduling flexibility using optimal switching, *Appl.Math. Finance* **15**, 405–447.
- [22] Chen, Z.J. (2010) Strong laws of large numbers for capacities, in *arXiv:1006.0749v1*.
- [23] Chen, Z. and Epstein, L. (2002), Ambiguity, Risk and Asset Returns in Continuous Time, *Econometrica*, **70**(4), 1403–1443.
- [24] Chen Zengjing, Tao Chen and Matt Davison, (2005) Choquet expectation and Peng’s g -expectation, *The Annals of Probability*, **33** (3), 1179–1199.
- [25] Cheridito, P., Soner, H.M., Touzi, N. and Victoir, N. (2007) Second order BSDE’s and fully nonlinear PDE’s, *Communications in Pure and Applied Mathematics*, **60**(7): 1081–1110.
- [26] Coquet, F., Hu, Y., Memin J. and Peng, S. (2002) Filtration Consistent Nonlinear Expectations and Related g -Expectations, *Probab. Theory Relat. Fields* **123**, 1–27.
- [27] Crandall, M., Ishii, H., and Lions, P.-L. (1992) User’s guide to viscosity solutions of second order partial differential equations, *Bulletin of The American Mathematical Society*, **27**(1), 1–67.
- [28] Cvitanic, and J. Karatzas, I. (1993) Hedging contingent claims with constrained portfolios, *The Annals of Proba.* **3**(4), 652–681.
- [29] Cvitanic, J. and Karatzas, I. (1996) Backward stochastic differential equations with reflection and Dynkin games, *The Annals of Prob.* 1996, **24**(4), 2024–2056.
- [30] Cvitanic, J. Karatzas, I. and Soner, M. (1998) Backward stochastic differential equations with constraints on the gains-process, *Ann. Probab.* 26(4), 1522–1551.
- [31] Darling, R. (1995) Constructing gamma-martingales with prescribed limit, using backward SDE, *The Annals of Proba.* **23**(3) 1234–1261.
- [32] Delarue, F. (2002) On the existence and uniqueness of solutions to FBSDEs in a non-degenerate case, *Stochastic Processes and Their Applications*, **99**, 209–286.
- [33] Delarue, F. and Menozzi, S. (2006) A Forward-Backward Stochastic Algorithm for Quasi-Linear PDEs, *The Annals of Applied Probaba.*, **16**(1), 140–184.

- [34] Delbaen, F. (2002), Coherent Risk Measures (Lectures given at the Cattedra Galileiana at the Scuola Normale di Pisa, March 2000), Published by the Scuola Normale di Pisa.
- [35] Delbaen, F., Rosazza Gianin, E. and Peng S. (2009) Representation of the penalty term of dynamic concave utilities, *Finance and Stochastics*, 0949–2984.
- [36] Delbaen, F. and Tang, S. (2010) Harmonic analysis of stochastic equations and backward stochastic differential equations, *Probab. Theory and Relat. Fields*, **146** 291–336.
- [37] Denis, L., Hu, M. and Peng, S. (2008) Function spaces and capacity related to a Sublinear Expectation: application to G-Brownian Motion Pathes, see arXiv:0802.1240v1.
- [38] Denis, L. and Martini, C. (2006) A Theoretical Framework for the Pricing of Contingent Claims in the Presence of Model Uncertainty, *The Annals of Applied Probability*, vol. 16, No. 2, pp 827–852.
- [39] Douglas, J., Ma, J. and Protter, P. (1996) Numerical methods for forward-backward stochastic differential equations, *Ann. Appl. Probab.* **6**(3), 940–968.
- [40] Duffie, D. and Epstein, L. (1992) Appendix C with Costis Skiadas, *Stochastic Differential Utility*, *Econometrica*, **60**(2), 353–394.
- [41] El Karoui, N. and Huang, S. (1997) A general result of existence and uniqueness of backward stochastic differential equations.
- [42] El Karoui, N., Kapoudjian, C., Pardoux, E., Peng, S. and Quenez M.-C. (1997), Reflected Solutions of Backward SDE and Related Obstacle Problems for PDEs, *Ann. Probab.* **25**, no 2, 702–737.
- [43] El Karoui, N., Peng, S. and Quenez, M.-C. (1997) Backward stochastic differential equation in finance, *Math. Finance* **7**(1), 1–71.
- [44] El Karoui, N., Peng, S. and Quenez, M.C. (2001) A dynamic maximum principle for the optimization of recursive utilities under constraints, *Ann. Appl. Prob.* **11**(3), 664–693.
- [45] El Karoui, N. and Quenez, M.-C. (1995) Dynamic programming and pricing of contingent claims in an incomplete market, *SIAM Control and Optim.* **33**(1) (1995), 29–66.
- [46] Elworthy D. (1993) Stochastic differential geometry, *Bull. Sc. Math. 2e series*, **117**, 7–28.
- [47] Englezos, N. and Karatzas, I. (2009) Utility maximization with habit formation: dynamic programming and stochastic PDEs, *SIAM J. Control* **48**, 481–520.
- [48] Föllmer, H. and Schied, A. (2004) *Statistic Finance*, Walter de Gruyter.
- [49] Fuhrman, M. and Tessitore, G. (2002) Nonlinear Kolmogorov equations in infinite dimensional spaces: the backward stochastic differential equations approach and applications to optimal control, *Ann. Probab.* **30**(3) 1397–1465.
- [50] Gao, F.Q. (2009) Pathwise properties and homeomorphic flows for stochastic differential equations driven by G-Brownian motion, in *Stochastic Processes and their Applications*, 119(10), 3356–3382.

- [51] Gilboa, I. (editor) (2004) *Uncertainty in Economic Theory, Essay in honor of David Schmeidler's 65th birthday*, Routledge.
- [52] Gobet, E., Lemor, J.P. and Warin, X. (2005) A regression-based Monte Carlo method to solve backward stochastic differential equations, *Ann. Appl. Probab.*, **15**(3), 2172–2202.
- [53] Hamadène, S. (2002) Reflected BSDE's with discontinuous barrier and application, *Stochastics*, **74**(3–4) 571–596.
- [54] Hamadène, S. and Jeanblanc, M. (2007) On the Starting and stopping problem: application in reversible investments, *Mathematics of Operations Research* **32**(1), 182–192.
- [55] Hamadène, S. and Lepeltier, J.P. (1995) Zero-sum stochastic differential games and backward equations, *Syst. Control Lett.* **24**(4) 259–263.
- [56] Hamadène, S., Lepeltier, J.P. and Peng, S. (1997) BSDEs with Continuous Coefficients and Stochastic Differential games, in *Backward Stochastic Differential Equations*, Pitman Research Notes in Math. **364**, (El Karoui Mazliak edit.) 115–128.
- [57] Hamadène, S. and Ouknine, Y. (2003) Reflected backward stochastic differential equation with jumps and random obstacle, *Electronic Journal of Probability*, **8**(2), 1–20.
- [58] Hamadene S. and Zhang, J. (2010), Switching problem and related system of reflected backward SDEs. *Stochastic Processes and their applications*, **120**(4), 403–426.
- [59] Han, Y., Peng, S. and Wu, Z. (2010) Maximum principle for backward doubly stochastic control systems with applications, *SIAM J. Control*, **48**(7), 4224–4241.
- [60] Hu, M. (2009) Explicit solutions of G-heat equation with a class of initial conditions by G-Brownian motion, available via <http://arxiv.org/abs/0907.2748>.
- [61] Hu, M. and Peng, S. (2009a) On Representation Theorem of G-Expectations and Paths of G-Brownian Motion, *Acta Mathematicae Applicatae Sinica, English Series* **25**(3), 539–546.
- [62] Hu, M. and Peng, S. (2009b) *G-Lévy Processes under Sublinear Expectations*, arXiv:0911.3533v1.
- [63] Hu, Y. (1993) Probabilistic interpretations of a system of quasilinear elliptic partial differential equations under Neumann boundary conditions, *Stochastic Process and Their Applications* **48**, 107–121.
- [64] Hu, Y., Imkeller, P. and Müller, M. (2005) Utility maximization in incomplete markets, *Ann. Appl. Probab.* **15**(3), 1691–1712.
- [65] Hu, Y., Ma, J., Peng, S. and Yao, S. (2008) Representation theorems for quadratic-consistent nonlinear expectations, *Stochastic Processes and their Applications* Volume **118**(9), 1518–1551.
- [66] Hu, Y. and Peng, S. (1995) Solution Of Forward-Backward Stochastic Differential-Equations, *Probab. Theory Rel. Fiel.* **103**(2): 273–283.
- [67] Hu, Y. and Peng, S. (2010) Some Estimates for Martingale Representation under *G*-Expectation, in arXiv:1004.1098v1.

- [68] Hu, Y. and Tang, S. (2009) Multi-dimensional BSDE with oblique reflection and optimal switching, *Probab. Theory Relat. Fields* (2010) **147**, 89–121.
- [69] Hu, Y. (Yaozhong). and Peng, S. (2009) Backward stochastic differential equation driven by fractional Brownian motion, *SIAM J. Control* **48**(3), 1675–1700.
- [70] Huber, P.J., (1981) *Robust Statistics*, John Wiley & Sons.
- [71] Ji, S. and Zhou, X. (2008) The Neyman–Pearson lemma under g -probability, *Comptes Rendus Mathematique* **346**(3-4), 209–212.
- [72] Jia, G. (2008,) A uniqueness theorem for the solution of Backward Stochastic Differential Equations, *C.R.A.S. Mathematique* **346**(7-8), 439–444.
- [73] Kabanov, Y. (1978) On the Pontryagin maximum principle for the linear stochastic differential equations,” *Probabilistic Models and Control of Economical Processes*, CEML.
- [74] Kobylanski, M. (2000) Backward stochastic differential equations and partial differential equations with quadratic growth. *Ann. Probab.* 28, No.2, 558–602.
- [75] Krylov, N.V. (1987) *Nonlinear Parabolic and Elliptic Equations of the Second Order*, Reidel Publishing Company (Original Russian version by Nauka, Moscow, 1985).
- [76] Lepeltier, J.P. and San Martin, J. (1997) Backward stochastic differential equations with continuous coefficient. *Stat. Probab. Lett.* 32, No.4, 425–430.
- [77] Lepeltier, J.P. and Xu, M. (2005) Penalization method for reflected backward stochastic differential equations with one rcll barrier, *Statistics & Probability Letters*, **75**(1) 58–66.
- [78] Li, X. and Peng, S. (2009) Stopping Times and Related Itô’s Calculus with G-Brownian Motion, arXiv:0910.3871v1.
- [79] Lin, Q. (2009) Local time and Tanaka formula for G-Brownian motion, in arXiv:0912.1515v1.
- [80] Lyons, T. (1995). Uncertain volatility and the risk free synthesis of derivatives. *Applied Mathematical Finance* 2, 117–133.
- [81] Ma, J., Protter, P. and Yong J. (1994) Solving forward–backward stochastic differential equations explicitly, a four step scheme, *Proba.Theory Relat. Fields* **98**, 339–359.
- [82] Ma, J. and Yong, J. (1997) Adapted solution of a degenerate backward SPDE with applications, *Stochastic Process. Appl.* **70**, 59–84.
- [83] Ma, J. and Yong, J. (1999) On linear degenerate backward stochastic partial differential equations, *Probab. Theory Related Fields* **113**, 135–170.
- [84] Ma, J. and Yong J. (1999) *Forward-Backward Stochastic Differential Equations and Their Applications*, Lecture Notes in Math. 1702, Springer.
- [85] Ma, J. and Zhang J. (2002) Path regularity for solutions of backward stochastic differential equations, *Probab. Theory Relat. Fields* **122**(2), 163–190.
- [86] Ma, J., Zhang, J. and Zheng, Z. (2008) Weak solutions for forward–backward SDEs—a martingale problem approach, *Ann. Probab.* **36**(6) 2092–2125.
- [87] Maccheroni, F. and Marinacci, M. (2005) A strong law of large numbers for capacities. *The Annals of Probability* Vol. 33, No. 3, 1171–1178.

- [88] Marinacci, M. (1999) Limit laws for non-additive probabilities and their frequentist interpretation, *Journal of Economic Theory* 84, 145–195.
- [89] Nagai, H. (2005) Risk-sensitive portfolio optimization with full and partial information, *Stochastic analysis and related topics in Kyoto, Adv. Stud. Pure Math.*, **41**, 257–278,
- [90] Nisio, M. (1976) On stochastic optimal controls and envelope of Markovian semi-groups. *Proc. of int. Symp. Kyoto*, 297–325.
- [91] Nualart, D. and Schoutens, W. (2001) Backward stochastic differential equations and Feynman-Kac formula for Levy processes, with applications in finance, *Bernoulli* **7**(5) 761–776.
- [92] Oksendal, B., Proske, F. and Zhang T. (2005) Backward stochastic partial differential equations with jumps and application to optimal control of random jump fields, *Stochastics*, **77**, 381–399.
- [93] Pardoux, E. and Peng, S. (1990) Adapted solution of a backward stochastic differential equation, *Syst. Control Lett.*, **14**(1) 55–61.
- [94] Pardoux, E. and Peng, S. (1992) Backward stochastic differential equations and quasilinear parabolic partial differential equations, *Stochastic partial differential equations and their applications, Proc. IFIP, LNCIS* **176**, 200–217.
- [95] Pardoux, E. and Peng, S. (1994) Backward doubly stochastic differential equations and systems of quasilinear SPDEs, *Probab. Theory Relat. Fields* **98**(2), 209–227.
- [96] Pardoux, E. and Rascanu, A. (1999) Backward stochastic variational inequalities, *Stochastics*, **67**(3–4) 159–167.
- [97] Pardoux, E. and Tang, S. (1999) Forward-backward stochastic differential equations and quasilinear parabolic PDEs, *Probab. Theory Relat. Fields* **114**(2) 123–150.
- [98] Peng, S. (1990) A General Stochastic Maximum Principle for Optimal Control Problems, *SIAM J. Cont.* 28: 4, 966–979, 1990.
- [99] Peng, S. (1991a) Probabilistic Interpretation for Systems of Quasilinear Parabolic Partial Differential Equations, *Stochastics*, **37**, 61–74.
- [100] Peng, S. (1991b) A Generalized Hamilton-Jacobi-Bellman Equation, *Lect Notes Contr Inf.* **159** 126–134.
- [101] Peng, S. (1992a) Stochastic Hamilton-Jacobi-Bellman Equations, *SIAM J. Control* **30**(2), 284–304.
- [102] Peng, S. (1992b) A Generalized Dynamic Programming Principle and Hamilton-Jacobi-Bellmen equation, *Stochastics*, **38**, 119–134.
- [103] Peng, S. (1992c) A Nonlinear Feynman–Kac Formula and Applications, *Proceedings of Symposium of System Sciences and Control theory, Chen Yong ed.* 173–184, World Scientific, Singapore.
- [104] Peng, S. (1997a) BSDE and Stochastic Optimizations, in *Topics in Stochastic Analysis, Lecture Notes of Xiangfan Summer School (1995)* J. Yan, S. Peng, S. Fang and L.M. Wu, Ch.2, (Chinese vers.), Science Publication.

- [105] Peng, S. (1997b), BSDE and related g -expectation, in Pitman Research Notes in Mathematics Series, no.364, “Backward Stochastic Differential Equation”, Ed. by N. El Karoui & L. Mazliak., 141–159.
- [106] Peng, S. (1999a) Open problems on backward stochastic differential equations, Control of distributed parameter and stochastic systems, S. Chen (ed.) Kluwer Academic Publishers 265–273.
- [107] Peng, S. (1999) Monotonic limit theorem of BSDE and nonlinear decomposition theorem of Doob-Meyer’s type, Probab. Theory Rel. Fields. **113**(4), 473–499.
- [108] Peng, S. (2004a) Nonlinear expectation, nonlinear evaluations and risk measurs, in K. Back, T. R. Bielecki, C. Hipp, S. Peng, W. Schachermayer, Stochastic Methods in Finance Lectures, C.I.M.E.-E.M.S. Summer School held in Bressanone/Brixen, Italy 2003, (Edit. M. Frittelli and W. Runggaldier) 143–217, LNM 1856, Springer-Verlag.
- [109] Peng, S. (2004b) Filtration consistent nonlinear expectations and evaluations of contingent claims, Acta Mathematicae Applicatae Sinica, **20**(2) 1–24.
- [110] Peng, S. (2005a) Dynamically consistent nonlinear evaluations and expectations, arXiv:math.PR/0501415 v1.
- [111] Peng, S. (2005b) Nonlinear expectations and nonlinear Markov chains, Chin. Ann. Math. **26B**(2) 159–184.
- [112] Peng, S. (2004a) Nonlinear expectation, nonlinear evaluations and risk measurs, in K. Back, T. R. Bielecki, C. Hipp, S. Peng, W. Schachermayer, Stochastic Methods in Finance Lectures, 143–217, LNM 1856, Springer-Verlag.
- [113] Peng, S. (2006a) G -expectation, G -Brownian motion and related stochastic calculus of Itô’s type, in Stochastic Analysis and Applications, The Abel Symposium 2005, Abel Symposia, Edit. Benth et. al., 541–567, Springer-Verlag.
- [114] Peng, S. (2006b) Modelling Derivatives Pricing Mechanisms with Their Generating Functions, arXiv:math.PR/0605599 v1.
- [115] Peng, S. (2007a) Law of large numbers and central limit theorem under nonlinear expectations, in arXiv:math.PR/0702358v1 13 Feb 2007
- [116] Peng, S. (2007b) G -Brownian Motion and Dynamic Risk Measure under Volatility Uncertainty, in arXiv:0711.2834v1 [math.PR] 19 Nov 2007.
- [117] Peng, S. (2008a) Multi-dimensional G -Brownian motion and related stochastic calculus under G -expectation, Stochastic Processes and their Applications **118**(12), 2223–2253.
- [118] Peng, S. (2008b) A new central limit theorem under sublinear expectations, in arXiv:0803.2656v1 [math.PR].
- [119] Peng, S. (2009) Survey on normal distributions, central limit theorem, Brownian motion and the related stochastic calculus under sublinear expectations, Science in China Series A: Mathematics, **52**(7) 1391–1411.
- [120] Peng, S. (2010a) Nonlinear Expectations and Stochastic Calculus under Uncertainty, arXiv:1002.4546v1.
- [121] Peng, S. (2010b) Tightness, weak compactness of nonlinear expectations and application to CLT, arXiv: 1006.2541v1.

- [122] Peng, S. and Shi, Y. (2003) A type of time-symmetric forward-backward stochastic differential equations, *C. R. Math. Acad. Sci. Paris*, **336**, 773–778.
- [123] Peng, S. and Wu Z. (1999) Fully coupled forward-backward stochastic differential equations and applications to optimal control, *SIAM J. Control Optim* **37**(3) 825–843.
- [124] Peng, S. and Xu, M. (2003) Numerical Algorithms for Backward Stochastic Differential Equations with 1-d Brownian Motion: Convergence and Simulations, arxiv: math/0611864v5.
- [125] Peng, S. and Xu, M. (2005) Smallest g-supermartingales and related reflected BSDEs with single and double barriers, *Ann. I. H. Poincaré*, PR**41** 605–630.
- [126] Pham, H. (2005) On some recent aspects of stochastic control and their applications, *Probability Surveys*, **2** 506–549.
- [127] Ramasubramanian, S. (2002) Reflected backward stochastic differential equations in an orthant. *Proc. Indian Acad. Sci., Math. Sci.* **112**(2) 347–360.
- [128] Rascanu, A. (1999) Backward stochastic variational inequalities, *Stochastics*, **67**(3&4), 159–167.
- [129] Rouge, R. El Karoui, N. (2000) Pricing via utility maximization and entropy, *Math. Finance* **10**(2), 259–276.
- [130] Rosazza Gianin, E. (2006) Risk measures via g-expectations. *Insur. Math. Econ.* **39**, 19–34.
- [131] Situ, R. (1996) On solutions of Backward stochastic differential equations with jumps and applications, *Stochastic Process and their Applications*.
- [132] Soner, H.M., Touzi, N. and Zhang, J. (2009-2010) Martingale representation theorem for G -expectation, in arXiv:1001.3802v1.
- [133] Soner, H.M., Touzi, N. and Zhang, J. (2010), Wellposedness of Second Order Backward SDEs, Preprint.
- [134] Song, Y. (2010) Some properties on G -evaluation and its applications to G -martingale decomposition, in arXiv:1001.2802v1.
- [135] Song, Y. (2010) Properties of hitting times for G -martingale, in arXiv:1001.4907v2.
- [136] Tang, S. (1998) The maximum principle for partially observed optimal control of stochastic differential equations, *SIAM J. Control* **36**, 1596–1617.
- [137] Tang, S. (2003) General Linear quadratic optimal stochastic control Problems with random coefficients: linear stochastic Hamilton systems and backward stochastic Riccati equations, *SIAM J. Control Optim.* **42**(1), pp. 53–75.
- [138] Tang, S. (2005) Semi-linear systems of backward stochastic partial differential equations in R^n , *Chinese Ann. Math.* **B26**, 437–456.
- [139] Tang, S. and Li, X. (1994) Necessary conditions for optimal control of stochastic systems with random jumps, *SIAM J. Control and optimization*, Vol. 32, No. 5, 1447–1475.
- [140] Walley, P., (1991) *Statistical Reasoning with Imprecise Probabilities*, London: Chapman and Hall.

-
- [141] Wang, L. (1992) On the regularity of fully nonlinear parabolic equations: II, *Comm. Pure Appl. Math.* **45**, 141–178.
- [142] Wu, Z. (1999) The comparison theorem of FBSDE, *Statistics & Probability letters*, **44**, 1–6.
- [143] Xu, J. and Zhang, B. (2009) Martingale characterization of G-Brownian motion, in *Stochastic Processes and their Applications*, **119**(1), 232–248.
- [144] Yong, J. (1997) Finding adapted solutions of forward-backward stochastic differential equations method of continuation, *Probability Theory and Related Fields* **107**, 537–572.
- [145] Yong, J. and Zhou, X. (1999) *Stochastic Control –Hamiltonian Systems and HJB Equations*, Springer, *Applications of Mathematics* **43**.
- [146] Zhang, J.F. (2004) A numerical scheme for BSDEs, *The Annals of Applied Proba.*, **14**(1), 459–488.
- [147] Zhang, Q. and Zhao, H. (2007) Stationary solutions of SPDEs and infinite horizon BDSDEs, *Journal of Functional Analysis* **252**, 171–219.
- [148] Zhang, Y.N. and Zheng, W.A. (2002) Discretizing a backward stochastic differential equation. *Int. J. Math. Math. Sci.* **32**(2) 103–116.
- [149] Zhao, W., Chen, L. and Peng, S. (2006) A New kind of accurate numerical method for backward stochastic differential equations, *SIAM J. on Scientific Computing*, **28**(1).
- [150] Zhou, X. (1992) On the necessary conditions of optimal controls for stochastic partial differential equations, *SIAM J. Control* **31**, 1462–1478.

Proceedings of the International Congress of Mathematicians
Hyderabad, India, 2010

“Indian” Rules, “Yavana” Rules: Foreign Identity and the Transmission of Mathematics

Kim Plofker*

Abstract

Numerous ideas and methods derived from Indian mathematics became familiar in the west long before European scholars began systematically studying Sanskrit scientific texts. The name “Indian” was attached to many mathematical concepts and techniques in West Asia/North Africa and Europe starting at the beginning of the medieval period, from the “Indian numbers” and “Indian calculation” adopted by Arab mathematicians to the “Hindoo method” for solving quadratic equations in nineteenth-century algebra textbooks. Likewise, the Sanskrit term “Yavana”, originally a transliteration of “Ionian (Greek)” but later applied to other foreigners as well, was applied by Indian scholars to various foreign importations in the exact sciences. This talk explores the historical process of adoption and assimilation of “foreign mathematics” both in and from India.

Mathematics Subject Classification (2010). Primary 01A32; Secondary 01A40.

Keywords. Indian mathematics, European mathematics, Islamic mathematics, transmission.

Introduction

Nowadays, the very concept of an “International Congress of Mathematicians” refutes the idea that “foreign identity” somehow intrinsically affects the transmission of mathematics. Colleagues in a particular mathematical discipline from all over the world now read the same research papers, apply the same subject classifications to their field of study, and use the same criteria to judge the

*Department of Mathematics, Union College, Schenectady NY 12308, USA.
E-mail: kim_plofker@alumni.brown.edu

truth of their results. There are still foreign countries and foreign languages, but there is no more foreign mathematics.

It is sometimes argued that mathematics inherently transcends “foreignness” by its abstract and rigorous nature. Since, for example, every mathematician in every culture agrees that $2 + 2 = 4$, mathematics ranks as a universal language that makes other language differences irrelevant. But this observation overlooks the fact that even if mathematicians agree on the essential truth of a statement like $2 + 2 = 4$, there are many other things about it on which they can disagree: e.g., how it should be symbolically represented, how the calculation should be performed, and how its truth should be demonstrated. Historically, cultural and linguistic divisions—that is, “foreignness”—often coincided with the dividing lines in such disagreements. This paper examines how foreign identity affected perceptions of mathematics and mathematicians across one very marked cultural and linguistic divide: that between the Indians and the so-called “Yavanas”.

Yavanas and Indians. The Sanskrit name “Yavana” (or “Yona”) was originally a rendering of the Greek “Ionian”, an appellation of the Eastern Greeks who came into contact with Indians when Alexander the Great’s armies crossed the Himalayas. When Alexander turned westward again, not all of his troops went back with him. Some established petty states (the “Indo-Greek” kingdoms) in the north and west of India, and were known to their neighbors by Sanskrit titles like “Yavana-rāja”, “king of the Yavanas”.

In later centuries the name “Yavana” was applied to other foreigners entering India from the northwest, including the Indo-Scythians (“Śakas”), medieval Persian and Turkic Muslim groups, and sometimes even modern European colonists. The “Yavanas” treated here are mostly those of classical antiquity and medieval and early modern Europe.

Images of Indian Mathematics in the West

Ancient allusions. It was over twenty-three hundred years ago that the professional activities of the mathematical scientists of India seem to have made their first known appearance in a western text. The Greek ambassador to the court of Candragupta in northeastern India, Megasthenes, commented on the Indian “philosophers” as follows:

...[G]athered together in a great assembly at the beginning of the year, they foretell the droughts and rains, propitious winds and diseases and other things that may benefit the hearers. . . A philosopher who errs in his predictions incurs no other penalty than disgrace, and remains silent for the rest of his life. [37, pp. 91–92], [27, pp. 40–41]

These “philosophers” were apparently forerunners of the mathematician-astronomer-astrologers known from Sanskrit scientific texts in later centuries, who were responsible for astronomical and astrological predictions, maintaining the calendar, training students in the exact sciences, and developing new mathematical knowledge. The technical details of their learning don’t appear to have received much attention from Megasthenes and his contemporaries, who were much more interested in Indian geography and the varieties of Indian animals (particularly elephants). But from then on, scholars in the western tradition were at least dimly aware of a professional category of philosophers or learned men in India.

Nearly a thousand years after Megasthenes in 662 CE, the first known specific acknowledgement of Indian mathematical accomplishments surfaced in a western document, in the Syrian bishop Severus Sebokht’s famous allusion to the “nine signs” of the Indian decimal place-value numerals:

I will omit all discussion of the science of the Hindus, a people not the same as the Syrians; their subtle discoveries in this science of astronomy, discoveries that are more ingenious than those of the Greeks and the Babylonians; their valuable methods of calculation; and their computing that surpasses description. I wish only to say that this computation is done by means of nine signs. If those who believe, because they speak Greek, that they have reached the limits of science should know these things they would be convinced that there are also others who know something. [10], [28, pp. 225–227]

These “nine signs” would of course have been accompanied in the Indian numerals by a tenth, the round zero symbol to indicate an empty place, but Sebokht apparently did not consider the zero as representing a “number”. The “valuable methods of calculation” and “computing” that he ascribed to the Indians certainly included their decimal arithmetic, but we don’t know any other specifics of his acquaintance with Indian mathematics or astronomy.

The “Indian learned men” in European texts. A similar accolade to the “science of the Indians” appears in a late tenth-century Latin manuscript:

We must know that the Indians have a most subtle talent and all other races yield to them in arithmetic and geometry and the other liberal arts. And this is clear in the nine figures with which they are able to designate each and every degree of each order (of numbers). [3, p. 17]

The Indian figures were not in fact the first system ever devised for representing “each and every degree of each order” with a limited set of glyphs by means of the place-value principle. For instance, the ancient Babylonians alluded to by Sebokht had developed sexagesimal or base-60 place-value numerals for both

integer and fractional numbers, traces of which persisted in the common western sexagesimal units for measuring intervals of time and degrees of arc. But the Babylonian place-value system for ordinary numeration and arithmetic had not been passed on to its successor cultures, so the Indian “nine figures” were the first instance of place-value that medieval western mathematicians encountered.

The system of the ten numeral signs was thoroughly described a little later in various high-medieval European works that disseminated Indian calculation. Examples include Latin versions of al-Khwārizmī’s ninth-century Arabic text on decimal arithmetic, Latin translations of Hebrew works by the twelfth-century Jewish scholar Abraham ibn Ezra, and the *Liber abaci* or “Book of calculation” written by the Italian merchant and mathematician Leonardo of Pisa (“Fibonacci”) at the start of the thirteenth century. Leonardo explains:

[F]ollowing my introduction, as a consequence of marvelous instruction in the art, to the nine digits of the Indians, the knowledge of the art very much appealed to me before all others. . . [A]ll this, the algorism as well as the Pythagorean art, I considered as almost a mistake compared to the method of the Indians. . .

The nine Indian figures are: 9 8 7 6 5 4 3 2 1. With these nine figures, and with the sign 0 which the Arabs call zephir [Arabic *ṣifr*], any number whatsoever is written. . . [38, pp. 15–16], [11]

Remarks on the same topic attributed to Abraham ibn Ezra make it clear that not just the nine figures but the zero symbol as well were known to be of Indian origin, despite the zero’s Arabic name:

The learned men of India named all their numbers up through nine and drew figures for the nine numerals. . . [39, p. 2] It is the custom of the Indians to put a little circle like \circ as a sign if there is no degrees place [in a sexagesimal arc measurement]. [24, pp. 210, 96–98]

Indeed, ibn Ezra was aware not only of the techniques of Indian decimal arithmetic but also, more distantly, of Indian geometry as represented by their value of π :

The learned men of India say: If the diameter [of a circle] is 20000, then the periphery is 62838. [39, p. 87]

(This assertion is slightly mistaken: in fact, the circumference value for a diameter of 20000 known from Sanskrit texts as early as the sixth century is 62832, not 62838, equivalent to a π value of 3.1416 rather than ibn Ezra’s 3.1419 [16, pp. 2–3].) Ibn Ezra notes elsewhere that the “circumference of the Indians” is bigger by a factor of $\frac{107}{105}$ or $\frac{367}{360}$ than the circumference according to “arithmeticians” or “geometers” [24, pp. 209, 96–97], which indicates that such practitioners were using a value for π around 3.08.

How the Indian numerals became “Arabic”. The image of the mathematically astute Indians, now established in European scholarly consciousness, soon blossomed into various legends and imaginary attributions. Abraham ibn Ezra himself recounted an apocryphal story about how an eighth-century Jewish envoy to India from the caliph al-Şaffāh persuaded an Indian sage to introduce the decimal system in the west:

...[A] wise man of Arin [Ujjain in Madhya Pradesh, traditionally located on the Indian prime meridian] decided to come to the king for a large sum after the Jew promised him that he would stay for only one year, and then could return home. Then the wise man, whose name was Kankah, was brought to the king, and taught the Arabs the basis of number, which lies in nine characters. [29, p. 101]

As we know from Sebokht’s abovementioned comment, the Indian decimal numerals must in fact have penetrated to West Asia at least by the previous century. But by a natural process of elaboration and association, they were attached to the name of the semi-legendary Indian authority “Kankah” or Kanaka, who appeared in several similar elaborations in Islamic sources [30, vol. 2, p. 19].

Other myths evolved about the name “algorym” or “algorism” for the procedures of decimal arithmetic. The word was derived originally from the name of al-Khwārizmī, but later was traced to various fanciful sources, including an alleged “king of India”, as the following remarks in a fourteenth-century English arithmetic treatise [5, p. 28] attest:

And þis boke tretys þe Craft of Nombryng, þe quych crafte is called also Algorym. Ther was a kyng of Inde, þe quich heyth Algor, & he made þis craft. And after his name he called hit algorym; or els anoþer cause is quy it is called Algorym, for þe latyn word of hit s. Algorismus comes of Algos, grece, quid est ars, latine, craft on englis, and rides, quid est numerus, latine, A nombur on englys. . . this present craft ys called Algorismus, in þe quych we vse teen signys of Inde. Questio. Why ten fyguris of Inde? Solucio. for as I haue sayd afore þai were fonde fyrst in Inde of a kynge of þat Cuntre, þat was called Algor. [41, p. 3]

The shadowy figures of their Indian counterparts were obscured to some extent in the minds of western mathematicians by their nearer neighbors, the Arab and Jewish scholars from whose works many Latin mathematical texts were more directly derived. As the thirteenth-century scholar John of Sacrobosco noted in his *Algorismus Vulgaris* or *Popular Arithmetic*,

In this art we write [higher numbers] toward the left in the style of the Arabs, the inventors of this science. [12, p. 5] [4, p. 7]

The notion of the decimal place-value digits increasing in value from right to left not surprisingly suggested to Latin authors an association with the right-to-left script of Arabic or Hebrew. The identification of decimal place-value digits

as “Arabic numbers” eventually became standard in European mathematical writing. Mistrust of their exotic origin also inspired the label “foreigners’ (or barbarians’) numbers”; this name lingered as a routine technical term even after the decimal digits themselves were wholly naturalized in Europe, as when Jakob Bernoulli in the 1680’s used “numeri barbari, seu Arabici” and “numeri Romani” to designate rows and columns of a table of exponents [26, p. 18].

How the double false position method became “Indian”.

On the other hand, some mathematical practices attributed to the “learned men of the Indians” in western texts seem to have had little or no basis in actual Indian mathematics. A case in point is the so-called “method of increase and decrease” or double false position technique described in a Latin work, apparently a twelfth-century translation of a source in Hebrew or Arabic, titled *Liber augmenti et diminutionis vocatus numeratio divinationis, ex eo quod sapientes Indi posuerunt, quem Abraham compilavit et secundum librum qui Indorum dictus est composuit* or “Book of increase and decrease, called calculation of predicting, [or guessing] from what the Indian wise men established, which Abraham compiled and composed according to a book said [to be] of the Indians” [25, vol. 1, pp. 304–305]. The compiler of the source appears not to have been the abovementioned Abraham ibn Ezra [19, 18, p. 80], but the translator may have thought that the work was his. After a brief listing of the contents, the text begins:

I have compiled this book according to what the learned men of the Indians have found out about the calculation of predicting, investigating and seeking out the usefulness of that, and persevering it, and understanding its intention.

Whence therefore: there is a square from which a third of it is subtracted, and a quarter, and there is eight that remains. How much is the square? The start of the calculation is that you assume a guess of twelve. . . and you subtract a third and a fourth of it, which is seven, and five remains. Then you compare that with eight. . . it appears that you have an error of three too little.

Keep that, and then assume a second guess separate from the former, and let it be twenty-four, and subtract a third and a fourth of it, which is fourteen, and ten remains. So then you compare that with eight. . . And it appears that you have an error of two too much.

Multiply the error of the second guess, which is two, by the first guess, which is twelve, and 24 results. And multiply the error of the first guess, which is three, by the second guess, which is twenty-four, and it is 72. Therefore add 24 and 72, since one error is too little and the other too much. . . the sum will be ninety-six; then add the two errors, which are three and two, and five results; and then

divide ninety-six by five. . . and your result is nineteen drachmas and one-fifth drachma.

That is, given the following relation,

$$x^2 - \frac{1}{3}x^2 - \frac{1}{4}x^2 = 8 \quad \text{or} \quad \frac{5}{12}x^2 = 8,$$

one is to use two guesses to solve for x^2 , as follows.

First assume $x^2 = 12$, which when modified as stated in the problem gives $\frac{5}{12}x^2 = 5$, which falls short by 3 of the desired result 8. Then assume $x^2 = 24$ and get $\frac{5}{12}x^2 = 10$, which exceeds the desired result 8 by 2. Each guess is then multiplied by the error produced by the other guess, and the sum of the products is divided by the sum of the errors to give the true x^2 :

$$x^2 = \frac{2 \cdot 12 + 3 \cdot 24}{2 + 3} = \frac{96}{5}, \quad \text{and indeed} \quad \frac{5}{12} \cdot \frac{96}{5} = 8.$$

Despite the appearance of an x^2 term in this equation, it is essentially a linear expression, where the desired value is found by linearly interpolating between two arbitrary values. This is easy to see if we let w represent the value of x^2 and define an “error function” $f(w) = \frac{5}{12}w - 8$. The root of $f(w)$ is computed by linear interpolation between two guesses w_1 and w_2 , as the following graph illustrates:

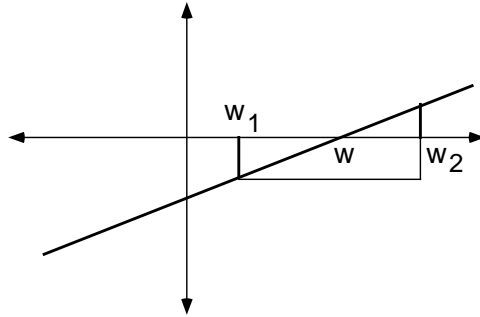

The similarity of the right triangles in the figure implies that

$$\frac{w - w_1}{|f(w_1)|} = \frac{w_2 - w_1}{|f(w_1)| + |f(w_2)|}$$

or equivalently,

$$w = \frac{w_2|f(w_1)| + w_1|f(w_2)|}{|f(w_1)| + |f(w_2)|}$$

which is equivalent to “Abraham’s” rule for the desired square.

This technique of linear interpolation with two supposed results in order to find the true result is the standard “regula elchataym” or “double-false” rule

common in Islamic and medieval western arithmetic, which was routinely ascribed by Arabic texts to “the Indians” [18, p. 81]. But in fact, the “double-false” rule illustrated here was not used in this way in Indian arithmetic. Sanskrit texts from at least the middle of the first millennium CE did use *iterated* linear interpolation (known as *Regula Falsi* in modern numerical analysis) exclusively to approximate solutions to certain *non*-linear equations in astronomy.

For solving linear equations, however, they used more efficient methods: either algebra procedures similar to our own or a simpler version of false position called “operation with an assumed [quantity]”, employing linear proportion to find the desired value with only one wrong guess [33, pp. 182–183]. For instance, to solve $\frac{5}{12}w = 8$, one might guess $w = 24$, find $\frac{5}{12} \cdot 24 = 10$, and proportionally compute the true $w = \frac{24 \cdot 8}{10} = \frac{96}{5}$. But typically, an Indian mathematician would prescribe simply setting up an equation in essentially the same way it is done today, allowing for some differences in notation. Compare the cumbersome “double-false” procedure in the Latin text with an actual Indian solution to a linear equation problem of the same period:

Two [people] have equal wealth. One has six horses and three hundred rupees, the other ten horses and a debt of a hundred rupees. . . What is the price of a horse?

$$\begin{array}{rcccc} y\bar{a} & 6 & r\bar{u} & 300 \\ & & & \bullet \\ y\bar{a} & 10 & r\bar{u} & 100 \end{array}$$

. . . When the difference of the rupees, $r\bar{u}$ 400, is divided by the difference of the unknowns, $y\bar{a}$ 4, the quotient is the amount of one unknown, 100. . . (Bhāskara, *Bīja-gaṇita* E36) [15, pp. 41–42]

The negative value is signified by an overdot, and the two sides of the equation are stacked vertically, without operators or equals sign, but the solution method is equivalent to our own.

It is not clear how mathematicians writing in Arabic, and consequently their Latin redactors and translators, acquired the notion that the popular non-iterated double false position method for solving linear equations was derived from the “learned men of the Indians”. Perhaps the attribution arose from a vague awareness of the Indian iterated double-false method, or perhaps it was part of a hitherto undocumented sub-scientific tradition of practical “merchant mathematics” among Indians [18, p. 81]; it is not attested in known Sanskrit compilations of practical mathematical rules [13, 14]. Or perhaps in this case the name “Indian” merely stood for an exotic source of arcane learning in general, as the names “Egyptian” and “Chaldaean” also sometimes did in western texts.

Evidence for “crypto-Indian” mathematics in Europe. Besides the various mathematical sources and concepts to which European authors explicitly assigned (rightly or wrongly) an Indian origin, there were various

features of the content and structure of arithmetic and algebra books in the Renaissance that distinctly resembled their counterparts in Sanskrit works, although not directly ascribed to Indian sources [17]. The classic “Rule of Three” or linear proportion (Sanskrit *trairāśika* or “[rule] of three quantities”), for instance, has been noted as bearing remarkably similar forms in early medieval India and in Renaissance Europe [36, pp. 152–153].

The organization of topics in arithmetic texts also suggests the possibility of Indian influence through transmission channels not yet traced. A more or less standard approximate order for basic arithmetic subjects had begun to develop at least by the middle of the first millennium CE in India. The following table roughly reproduces that order for some major topics in the renowned *Līlāvati* of the Indian mathematician Bhāskara, and juxtaposes it with the corresponding subject sequences in *L’arithmétique* of the sixteenth-century French scholar Jacques Peletier, as well as the *Liber abaci* of Leonardo [17, pp. 1–4], [38, pp. 5–11].

Bhāskara, 12th c.	Peletier, 1552	Fibonacci, 1202
Numeration	Def. of number	Numeration
Add/subtract	Add/subtract	Multiplication
Multiplication	Multiplication	Addition
Division	Division	Subtraction
Squaring		
Square root	Square root	Fractions with integers
Cubing		
Cube root	Cube root	Fraction arithmetic
Fractions	Fractions	Rule of three
Zero		
Inversion		
Single false pos. [...]	Double false pos.	Barter
Rules of three	Rules of three	Mixtures
Compound proportion	Compound proportion	Alloys
Barter		
Mixtures	Alloys	Single false pos./inversion
Interest		Double false pos.
Misc. [...]	Misc.	Roots
Alloys		
[...]	[...]	[...]

Numerous likenesses in the content as well as the classification of many of these arithmetic rules strengthen the plausibility of transmission. However, even if it were possible conclusively to rule out parallel evolution of any of these likenesses in the Indian and European traditions independently, we could not credibly deduce any direct impact from Sanskrit works on Renaissance

mathematics [17, p. 51]. Arguments for such transmission rely on hypotheses about contacts between sub-scientific traditions of recreational and commercial mathematics, about which we still know very little, rather than between scholarly authorities directly.

Awareness of some Indian sources in the modern period.

Shortly thereafter, European authors did increasingly come into direct contact with Indian sources of mathematical thought, which contained not only many interesting similarities to the mathematics they were already familiar with, but also some notably novel ideas. For instance, Simon de la Loubère, a French envoy to Siam, published in 1691 a description of methods for constructing magic squares that one of his countrymen had learned from the Indians of Surat [23, pp. 235–288]. However, the widespread interest his account inspired among European readers focused more on understanding and developing the algorithms for such constructions than on investigating their origins, and the Indian techniques eventually became known in Europe under the names of European researchers [6, pp. 295–299]. (More misleadingly still, the Indian technique widely known as the “De la Loubere” method is also commonly called the “Siamese method”, from erroneous association with de la Loubère’s embassy to Siam rather than with his reference to Surat [42, p. 1839].)

In a somewhat similar but more recent development, a certain form of the method for simplifying the solution of quadratic equations by “completing the square” was reported by early nineteenth-century scholars of Sanskrit technical works as due to the medieval Indian mathematician Śrīdhara [8, pp. 209–210], or more generally to “the Indians” [20, p. 197]. This technique was incorporated into various textbooks as the “Hindu Rule” or “Hindu Method”, but the name gradually dropped out of use (as did the method itself) in later texts, and the rule was subsequently rediscovered with no recognition of its Indian origin [35]. Once again, a mathematical concept originally recognized as Indian had begun to shed its foreign identity over time.

Images of Western Mathematics in India

Where Latin texts had their “barbari”, despised as uncouth or bizarre (or heathen) foreigners, Sanskrit texts similarly had their “*mlecchas*”, who were considered alien to sacred language and traditions. The stigma of *mleccha* identity was associated with their legendary origins among demonic beings called *asuras*, as recounted in, for instance, the ancient sacred text *Śatapatha-brāhmaṇa*:

Now the gods and the *asuras*, both of them sprung from [the creator] Prajāpati, entered upon their father Prajāpati’s inheritance. . . the gods came in for the sacrifice and *asuras* for speech [*vāc*]; the gods for that (heaven) and the *asuras* for this (earth). . .

The gods then cut her [*Vāc*] off from the *asuras*; and having gained possession of her and enveloped her completely in fire, they offered

her up...thereby they made her their own; and the *asuras*, being deprived of speech, were undone...

Such was the unintelligible speech which they then uttered—and he (who speaks thus) is a *mleccha* (barbarian). Hence let no Brāhmaṇa speak barbarous language, since such is the speech of the *asuras*. Thus alone he deprives his spiteful enemies of speech; and whosoever knows this, his enemies, being deprived of speech, are undone. [*Śatapatha-brāhmaṇa* 3.2.1.18–24]

The Brāhmaṇas or “Brahmins”, hereditary priests and scholars, were especially charged with maintaining Sanskrit learning and its divine laws, and consequently were admonished to avoid the corruption of barbarian contact: “A Brāhmaṇa who speaks with a *mleccha* must undergo purification” (*Viṣṇudharmaśāstra* 22.76).

However, this prohibition might sometimes be evaded or even directly challenged. One *mleccha* group widely viewed as transcending its alien status was the so-called “Yavanas”. They and other invaders such as the Śakas or Indo-Scythians were traditionally considered to be degraded types of Kṣatriyas or hereditary rulers, who had forfeited their earlier status by rebellion or other offenses against the gods:

[Yavanas] also, and other Kṣatriya races, [the sage Vasiṣṭha] deprived of the established usages of oblations to fire and the study of the Vedas; and thus separated from religious rites, and abandoned by the Brāhmaṇas these different tribes became *mlecchas*. (*Viṣṇupurāṇa* 4.3)

Yet this debased race was also described as being worthy of honor as the developers of certain mathematized forms of divination, specifically horoscopic astrology. The sixth-century astronomer/astrologer Varāhamihira famously remarked of them:

For although the Yavanas are *mlecchas*, they have brought this science to perfection and so are honored like sages; how much more honorable, then, is an astrologer who is a Brāhmaṇa. (*Bṛhatsaṃhitā* 2.15 [21, p. 8])

And in fact, the founding texts of Indian mathematical astrology in the second through fourth centuries CE were composed by Indianized Yavana authors, and openly acknowledged Greek inspiration [31, p. 81]. Later Sanskrit astrology texts retained dozens of Greek loanwords for astrological and astronomical technical terms, and quoted multiple authors with the name or epithet “Yavana” [32, pp. 34–38]. There seems to have been no fear of contamination from *mleccha* speech in retaining Sanskrit words like *liptā*, “arc-minute” (from Greek *lepton*) and *kendra*, “center” or “anomaly” (from Greek *kentron*).

The invention of the sine. In the non-astrological Indian mathematical sciences, however, there are many fewer direct references to western sources, and the mathematical features in them that suggest a western origin, such as trigonometry of chords and spherical coordinates, are not explicitly flagged as “foreign” [34, pp. 118–119]. We can reconstruct the process of transmission in these instances only as a plausible hypothesis. In the case of trigonometry, for example, we have only the two variants of the subject that appeared in ancient Greece and ancient India, plus our knowledge of the Indian adoption of Greek astrology and some of its astronomical components at about this time.

The differences between the Greek and Indian versions of trigonometry supply some hints about the hypothesized transmission process. Greek trigonometry, which tabulates only the chords of angles at the center of the circle, is computationally somewhat clumsy: as illustrated on the left side of the diagram below, solving a right triangle with chords requires doubling the given angle (at the circumference) to find the side opposite to it (which is the chord of the angle at the center, equal to twice the angle at the circumference). The corresponding figure on the right represents the Indian form of the solution, which is more efficient: half-chords (sines) are tabulated rather than chords, so any given right triangle can be solved directly with no doubling of angles. The sine, in this view, represents a later Indian improvement on the original “Yavana” chord.

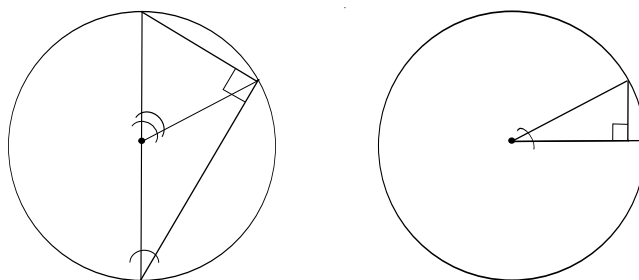

The standard Sanskrit names for the sine or opposite side to the given angle, which mean “bowstring” or half-bowstring”, also suggest that the sides of right triangles in circles were first perceived as chords, with the arcs subtending them reminiscent of an archer’s bow. The same name “bowstring” was then applied to the more convenient sine quantity. But since the Sanskrit texts are silent on how these techniques and terms originated, any such reconstruction remains conjectural.

The direct absorption of western learning into Indian mathematics *per se* appears to have commenced only toward the middle of the second millennium, when Sanskrit mathematical authors confronted various Islamic works expounding and extending the results of Hellenistic Greek science. The “Yavana” identity now generally embraced the Central and West Asian Muslim authors of such works as well as the Greek authors who inspired them, but at least some of

the Indian translators were aware of the historical and linguistic complexity of the sources. The following introduction to an early eighteenth-century Sanskrit translation of an Arabic version of Theodosius's *Spherics* from the late first millennium BCE illustrates this awareness, and also some of the pitfalls of transliteration:

This book called *Ukarā* [Arabic *kura*, “sphere”], made by Sāvajūsayūsa [Theodosius]...[was translated] from the Yunānī [Arabic, “Ionian, Greek”] language to the Arava language by Abu-la Accā sa-a-ha-sa-ha...The fifth figure of the third chapter was arranged by Kustā vivi Lukā [Qustā ibn Lūqā]...It was corrected by Sābit vini Kusai [Thābit ibn Qurra]. The commentary was made by Narasīra [Naṣīr al-Dīn Ṭūsī]. It is rendered into Sanskrit words by Nayanasukha. [2, p. 1]

Acknowledgement of Yavana sources did not necessarily imply endorsement of Yavana vocabulary in Sanskrit mathematics. Contrast the treatment of the word “parallel”, for which the Sanskrit geometry of this era had devised the technical term *samānāntara* (“equal-differenced”), in Nayanasukha's translation of the *Spherics* and in the *Hayata-grantha*, a Sanskrit translation of the Persian spherical astronomy treatise *Risāla dar hay'a* made probably in the seventeenth century:

[*Hayata-grantha*:] When one has made two lines, and made points on one line, if there is equal-difference with points on the other line, then the two equal-differenced lines are called *mutavāḥijyena* [Arabic *mutawāẓin*, “parallel”]. [1, p. 11]

[Nayanasukha:] Two circles on a sphere whose poles are not distinct are equal-differenced circles. [2, p. 13] (*Spherics* 2.2)

Other translations by Nayanasukha, however, are less strict in their avoidance of transliterated Arabic or Persian words [22, p. 7]. Clearly, while it was seen as desirable to construct a proper Sanskrit technical vocabulary for new mathematical concepts in foreign topics like spherical trigonometry and Ptolemaic astronomy, it was not considered necessary to obliterate all trace of their Yavana origins or their *mleccha* tongues.

Perceptions of the “Indians”, the “Yavanas”, and their Knowledge

What patterns can we trace in these examples of acquisition and assimilation of “foreign” mathematics? For one thing, it is clear that an explicit “foreign” label or the absence thereof on a particular concept does not necessarily mean much. Not surprisingly, such labels are likely to be most accurate at the point

closest to the actual transmission, and recede into irrelevance or fantasy once the concept has become integrated into the receiving tradition.

Such assimilation seems to be often particularly thorough in mathematics, where, for example, even in the information-rich twentieth century the association of a certain algorithm with Indian sources could be largely forgotten in the space of fifty years or so. The internal logic of the structure of mathematics means that identical innovations can emerge independently in different linguistic traditions more easily than in, say, poetry or dialectic; it is also easier for a foreign innovation to take on the coloring of its new environment as an abstract idea.

Nonetheless, in both the western and the Indian traditions a recognized although indistinct picture of the mathematical “foreigners” as a culture seems to have emerged. They were strange; they were wise; they were (possibly) accursed and a threat to civilization; they were fellow-scholars; they had new ideas. Their mutual contributions not only enriched each other’s separate mathematical traditions but ultimately enabled their convergence into today’s common global culture of mathematical research, where there are no strangers anymore.

References

- [1] V.B. Bhattācārya, *Hayata*, Varanaseya Sanskrit Vishvavidyalaya, Varanasi, 1967.
- [2] V.B. Bhattācārya, *Ukarā*, Sampurnanand Sanskrit Vishvavidyalaya, Varanasi, 1978.
- [3] Charles Burnett, “The Semantics of Indian Numerals in Arabic, Greek and Latin”, *Journal of Indian Philosophy* 34, 2006, 15–30.
- [4] Charles Burnett, “Manuscripts of Latin Translations of Scientific Texts from Arabic”, *Proceedings of the Lawrence J. Schoenberg Symposium on Manuscript Studies in the Digital Age* 1, 2009, 1–11.
- [5] Javier Calle Martín and Antonio Miranda García, “Editing Middle English Punctuation. The Case of MS Egerton 2622 (ff. 136–152)”, *International Journal of English Studies*, 5, 2005, 27–44.
- [6] Schuyler Cammann, “Islamic and Indian Magic Squares, Part II”, *History of Religions*, 8, 1969, 271–299.
- [7] Christoph Clavius, *Geometria practica*, Aloysius Zannetti, Rome, Italy, 1604.
- [8] Henry Thomas Colebrooke, *Algebra, with Arithmetic and Mensuration, from the Sanscrit of Brahmagupta and Bhāscara*, John Murray, London, England, 1817.
- [9] Yvonne Dold-Samplonius et al., *From China to Paris: 2000 Years Transmission of Mathematical Ideas*, Steiner Verlag, Stuttgart, Germany, 2002.
- [10] Jekuthial Ginsburg and D.E. Smith, “New Light on Our Numerals”, *Bulletin of the American Mathematical Society*, 23, 1917, 366–369.
- [11] R.E. Grimm, “The Autobiography of Leonardo Pisano”, *Fibonacci Quarterly*, 11, 1973, 99–104.

- [12] James Orchard Halliwell, *Rara Mathematica*, Maynard, London, England, 1841.
- [13] Takao Hayashi, *The Bakhshālī Manuscript*, Egbert Forsten, Groningen, Netherlands, 1995.
- [14] Takao Hayashi, “A Sanskrit Mathematical Anthology”, *SCIAMVS* 7, 2006, 175–211.
- [15] Takao Hayashi, “Bijaganita of Bhāskara”, *SCIAMVS* 10, 2009, 4–301.
- [16] Takao Hayashi, Takanori Kusuba and Michio Yano, “Indian Values for π Derived from Āryabhaṭa’s Value”, *Historia Scientiarum*, 37, 1989, 1–16.
- [17] Albrecht Heeffer, “The Tacit Appropriation of Hindu Algebra in Renaissance Practical Arithmetic”, *Gaṇita Bhāratī* 29, 2007, 1–60.
- [18] Jens Høyrup, *Jacopo da Firenze’s Tractatus Algorismi and Early Italian Abacus Culture*, Birkhäuser, Basel, Switzerland, 2007.
- [19] Jens Høyrup, “Further questions to the historiography of Arabic (but not only Arabic) mathematics from the perspective of Romance abacus mathematics”, Contribution to 9ième Colloque Maghrébin sur l’Histoire des Mathématiques Arabes, Tipaza, 12–14 May 2007.
- [20] Charles Hutton, *A Course of Mathematics*, vol. 1, 11th ed., Gilbert & Rivington, London, England, 1836.
- [21] H. Kern, *The Bṛhat Saṅgīta of Varāha-Mihira*, Baptist Mission Press, Calcutta, 1865.
- [22] Takanori Kusuba and David Pingree, *Arabic Astronomy in Sanskrit*, Brill, Leiden, Netherlands, 2002.
- [23] Simon de La Loubère, *Description du Royaume de Siam*, vol. 2, Mortier, Amsterdam, Netherlands, 1714.
- [24] Tony Lévy and Charles Burnett, “*Sefer ha-Middot*: A Mid-Twelfth-Century Text on Arithmetic and Geometry Attributed to Abraham ibn Ezra”, *Aleph*, 6, 2006, 57–238.
- [25] Guillaume Libri, *Histoire des mathématiques en Italie*, 4 vols., Renouard, Paris, France, 1838.
- [26] Francis Maseres, *The Doctrine of Permutations and Combinations*, White, London, England, 1795.
- [27] J.W. McCrindle, *Ancient India as Described by Megasthenes and Arrian*, Trübner, London, England, 1877.
- [28] F. Nau, “Notes d’astronomie syrienne”, *Journal asiatique*, series 10, 16, 1910, 209–228.
- [29] David Pingree, “The Fragments of the Works of Ya’qūb Ibn Ṭāriq”, *Journal of Near Eastern Studies*, 27, 1968, 97–125.
- [30] David Pingree, *Census of the Exact Sciences in Sanskrit*, Series A, vols. 1–5, American Philosophical Society, Philadelphia, USA, 1970–1994.
- [31] David Pingree, *Jyotiḥśāstra*, Harrassowitz, Wiesbaden, Germany, 1981.
- [32] David Pingree, *From Astral Omens to Astrology, from Babylon to Bīkāner*, Istituto Italiano per l’Africa e l’Oriente, Rome, Italy, 1997.

- [33] Kim Plofker, “Use and Transmission of Iterative Approximations in India and the Islamic World”, in [9].
- [34] Kim Plofker, *Mathematics in India*, Princeton University Press, Princeton, USA, 2009.
- [35] Dave L. Renfro, “The Hindu method for completing the square”, *Mathematical Gazette*, 91, 2007, 198–201.
- [36] Sreeramula Rajeswara Sarma, “Rule of Three and its Variations in India”, in [9].
- [37] E.A. Schwanbeck, *Megasthenes Indica*, Plemesius, Bonn, Germany, 1846.
- [38] L.E. Sigler, *Fibonacci’s Liber abaci*, Springer, New York, USA, 2002.
- [39] Moritz Silberberg, *Sefer ha-Mispar*, Kauffmann, Frankfurt, Germany, 1895.
- [40] David Eugene Smith and Louis Charles Karpinski, *The Hindu-Arabic Numerals*, Ginn & Co., Boston, 1911.
- [41] Robert Steele, *The Earliest Arithmetics in English*, Oxford University Press, London, UK, 1922.
- [42] Eric W. Weisstein, *CRC Concise Encyclopedia of Mathematics*, 2nd ed., Chapman & Hall/CRC, Boca Raton, Florida, USA, 2003.

Riemannian Manifolds of Positive Curvature

Simon Brendle* and Richard Schoen*

Abstract

The study of positive sectional curvature is one of the oldest pursuits in Riemannian geometry, but despite the considerable efforts of many researchers, basic questions remain unanswered. In this lecture we will briefly summarize the state of knowledge in this area and outline the techniques which have had success. These techniques include geodesic and comparison methods, minimal surface methods, and Ricci flow. We will then describe our recent work (see [18], [21], [22]) which uses the Ricci flow to resolve the differentiable sphere theorem; that is, the complete classification of manifolds whose sectional curvatures are $1/4$ -pinched.

Mathematics Subject Classification (2010). Primary 53C20; Secondary 53C21, 53C44, 35K55

Keywords. Riemann curvature tensor, Ricci flow, strong maximum principle, symmetric space

1. Preliminaries and the Main Theorems

We let M denote a smooth manifold of dimension n . Recall that a Riemannian metric on M is a choice g of inner product on each tangent space which varies smoothly from point to point. Any manifold admits an infinite dimensional family of Riemannian metrics, but the question of whether a manifold admits metrics with desired geometric properties is one of the basic questions of global Riemannian geometry. Surfaces embedded in \mathbb{R}^3 provide important examples of two dimensional Riemannian manifolds where the metric g is the restriction of the euclidean inner product to each tangent space. The geometry of surfaces was developed by Gauss in the early nineteenth century. Gauss understood

*Department of Mathematics, Stanford University, Stanford, CA 94305.
E-mails: brendle@math.stanford.edu and schoen@math.stanford.edu

aspects of the geometry of surfaces which are intrinsic in that they depend only on the metric g as opposed to those geometric aspects which depend on the way in which the surface is embedded in space. In his famous Theorema Egregium, Gauss identified the function K equal to the product of the principal curvatures, which we call the Gauss curvature of a surface. He showed that K can be expressed in terms of g and its first two derivatives. This means that if we choose local coordinates x^1, x^2 on the surface and express the metric in terms of the coordinate vector fields ∂_1, ∂_2 by $g_{ij} = \langle \partial_i, \partial_j \rangle$ then the function K has an expression involving the g_{ij} and its first and second derivatives. Among other things Gauss showed that $K = 0$ if and only coordinates can be introduced in a neighborhood of any point in which $g_{ij} = \delta_{ij}$; that is, the metric is locally equivalent to the euclidean space \mathbb{R}^2 .

In 1854 Riemann extended Gauss' theory of the intrinsic geometry of surfaces to higher dimensions. In particular, he found an expression involving the metric and its first two derivatives whose vanishing characterizes those metrics which are locally equivalent to the euclidean metric on \mathbb{R}^n . To describe this expression, let M denote a manifold of dimension n , and let g be a Riemannian metric on M . The curvature of (M, g) is described by the Riemann curvature tensor R . This gives, for each point $p \in M$, a multilinear function $R : T_p M \times T_p M \times T_p M \times T_p M \rightarrow \mathbb{R}$. From its construction, the Riemann curvature tensor satisfies the symmetries

$$R(X, Y, Z, W) = -R(Y, X, Z, W) = R(Z, W, X, Y) \quad (1)$$

and the first Bianchi identity

$$R(X, Y, Z, W) + R(Y, Z, X, W) + R(Z, X, Y, W) = 0 \quad (2)$$

for all tangent vectors $X, Y, Z, W \in T_p M$. By contracting the Riemann curvature tensor with respect to the metric, we obtain the Ricci and scalar curvature of (M, g) :

$$\text{Ric}(X, Y) = \sum_{k=1}^n R(X, e_k, Y, e_k)$$

and

$$\text{scal} = \sum_{k=1}^n \text{Ric}(e_k, e_k).$$

Here, X, Y are arbitrary vectors in the tangent space $T_p M$, and $\{e_1, \dots, e_n\}$ is an orthonormal basis of $T_p M$.

Although the curvature of a higher dimensional Riemannian manifold is a much more complicated object than the Gaussian curvature of a surface, it turns out to be possible to understand R in terms of Gauss curvatures of surfaces embedded in M . To explain this, we consider a two dimensional plane π in the tangent space $T_p M$, and we consider all geodesics emanating from p that are tangent to the plane π . The union of these geodesics rays forms a

two-dimensional surface $\Sigma \subset M$; more formally, the surface Σ is defined as $\Sigma = \exp_p(U \cap \pi)$, where $\exp_p : T_p M \rightarrow M$ denotes the exponential map and $U \subset T_p M$ denotes a small ball centered at the origin. With this understood, the sectional curvature $K(\pi)$ is defined to be the Gaussian curvature of the two-dimensional surface Σ at the point p .

The sectional curvatures can be described precisely in terms of R : given any point $p \in M$ and any two dimensional plane $\pi \subset T_p M$, the sectional curvature of π is defined by

$$K(\pi) = \frac{R(X, Y, X, Y)}{|X|^2 |Y|^2 - \langle X, Y \rangle^2},$$

where $\{X, Y\}$ is a basis of π . Note that this definition is independent of the choice of the basis $\{X, Y\}$, and that if X, Y are chosen to be an orthonormal basis then the denominator is equal to 1. Because of the symmetries of R it turns out that the sectional curvatures algebraically determine all components of R at a given point p .

We say that a Riemannian manifold has *positive curvature* if all sectional curvatures are positive at all points of M . Perhaps the most basic example of a Riemannian manifold of positive curvature is the n -dimensional sphere S^n with its standard metric arising from its embedding as the unit sphere in \mathbb{R}^{n+1} . This manifold has constant sectional curvature 1; that is, $K(\pi) = 1$ for all two-dimensional planes π . Conversely, it was shown by H. Hopf in 1926 that a compact, simply connected Riemannian manifold with constant sectional curvature 1 is necessarily isometric to the sphere S^n , equipped with its standard metric (see [53], [54]). More generally, if (M, g) is a compact Riemannian manifold with constant sectional curvature 1, then (M, g) is isometric to a quotient S^n/Γ , where Γ is a finite group of isometries acting freely. These quotient manifolds are completely classified (see [83]) and they are referred to as *spherical space forms*. The simplest examples of spherical space forms are the sphere S^n and the real projective space $\mathbb{R}P^n$. When n is even, these are the only examples. By contrast, there is an infinite collection of spherical space forms for each odd integer n .

In case of dimension $n = 2$ it is a classical result that the only compact surfaces which can be given metrics of positive curvature are S^2 and $\mathbb{R}P^2$. This follows from the Gauss-Bonnet Theorem which asserts that for any metric the integral of K over the surface is equal to 2π times the Euler characteristic. Thus if K is positive the Euler characteristic must be positive, and from the classification of compact surfaces it follows that M is diffeomorphic to either S^2 or $\mathbb{R}P^2$.

For $n \geq 3$ it is a much more difficult task to classify those compact manifolds which can be given metrics of positive curvature, and we can only give partial answers. There are families of positively curved manifolds which are called *compact rank one symmetric spaces* (CROSS). These include S^n and $\mathbb{R}P^n$ as well as other manifolds which are not spherical space forms. One such family consists of the complex projective spaces $\mathbb{C}P^n$ for $n \geq 2$. The manifold $\mathbb{C}P^n$ is the set of

complex lines through the origin in \mathbb{C}^{n+1} , or it may be alternatively described as the quotient of the unit sphere S^{2n+1} in \mathbb{C}^{n+1} by the circle action consisting of multiplication by $e^{i\theta}$ for $\theta \in S^1$. The metric on S^{2n+1} induces a natural metric on $\mathbb{C}\mathbb{P}^n$. Now since $\mathbb{C}\mathbb{P}^n$ has a complex structure which is compatible with this metric, a two plane π in $T_p M$ might be complex, meaning that it is invariant under multiplication by $\sqrt{-1}$; it might be totally real, meaning that multiplication by $\sqrt{-1}$ takes π to an orthogonal two plane; or it might be somewhere between these extremes. It turns out that if we normalize the metric so that all complex two planes have curvature 1, then the algebra of the curvature tensor implies that the totally real two planes must have curvature $1/4$, and all two planes have curvature in the interval $[1/4, 1]$. Note that the real dimension of $\mathbb{C}\mathbb{P}^n$ is $2n$. There is a similar construction with the complex numbers replaced by the quaternions \mathbb{H} , and this produces the quaternionic projective spaces $\mathbb{H}\mathbb{P}^n$ for $n \geq 2$. These are CROSS manifolds of dimension $4n$, and they also have natural metrics with sectional curvatures in the interval $[1/4, 1]$. There is one remaining CROSS manifold of dimension 16 called the Cayley projective plane (see [4] for a detailed description). It also has a natural metric with sectional curvatures in the interval $[1/4, 1]$.

In addition to manifolds which are locally CROSS (covered by a CROSS manifold), there are a few other constructions which have yielded metrics of positive curvature on other manifolds. First, the compact homogeneous manifolds of positive curvature have been classified by Berger [10], Aloff and Wallach [2], Wallach [81], and Bérard-Bergery [6]. Secondly, there are biquotient constructions by Eschenburg [31] and Bazaikin [5]. The combination of these constructions give non-CROSS examples in dimensions 6, 7, 12, 13, and 24. In dimensions 7 and 13 they produce infinitely many distinct examples. The study of manifolds of positive curvature with symmetry is being actively pursued by a number of authors. We refer the reader to Grove [41] for a recent survey of this topic.

There are very few general obstructions known to the existence of metrics of positive curvature on compact manifolds of dimension 4 or more. In the next section we will summarize what is known and give an overview of the methods which have been effective. As a step toward the classification problem Hopf conjectured that a compact, simply connected Riemannian manifold whose sectional curvatures are close to 1 should be homeomorphic to a sphere (see Marcel Berger's account in [13], page 545). This idea is formalized by the notion of curvature pinching, which goes back to H. Hopf and H.E. Rauch:

Definition 1.1. A Riemannian manifold (M, g) is said to be weakly δ -pinched in the global sense if the sectional curvature of (M, g) satisfies $\delta \leq K \leq 1$. If the strict inequality holds, we say that (M, g) is strictly δ -pinched in the global sense.

For our purposes, it will be convenient to consider the weaker notion of pointwise pinching. This means that we only compare sectional curvatures

corresponding to different two dimensional planes based at the same point $p \in M$:

Definition 1.2. We say that (M, g) is weakly δ -pinched in the pointwise sense if $0 \leq \delta K(\pi_1) \leq K(\pi_2)$ for all points $p \in M$ and all two dimensional planes $\pi_1, \pi_2 \subset T_p M$. If the strict inequality holds, we say that (M, g) is strictly δ -pinched in the pointwise sense.

Hopf's pinching problem was first taken up by H.E. Rauch after he visited Hopf in Zürich during the late 1940s ([13], page 545). In a seminal paper [72], Rauch showed that a compact, simply connected Riemannian manifold which is strictly δ -pinched in the global sense is homeomorphic to S^n ($\delta \approx 0.75$). Furthermore, Rauch posed the question of what the optimal pinching constant δ should be. This question was settled around 1960 by the celebrated Topological Sphere Theorem of M. Berger and W. Klingenberg:

Theorem 1.3 (M. Berger [8], W. Klingenberg [59]). *Let (M, g) be a compact, simply connected Riemannian manifold which is strictly $1/4$ -pinched in the global sense. Then M is homeomorphic to S^n .*

The classical proof of the Topological Sphere Theorem relies on comparison geometry techniques which were refined during the 1950's (see e.g. [28], Chapter 6). There are several ways in which one might hope to improve Theorem 1.3. A natural question to ask is whether the global pinching condition in Theorem 1.3 can be replaced by a pointwise one. Furthermore, one would like to extend the classification in Theorem 1.3 to include manifolds that are not necessarily simply connected. By applying Theorem 1.3 to the universal cover, one can conclude that any compact Riemannian manifold which is strictly $1/4$ -pinched in the global sense is homeomorphic to a quotient of a sphere by a finite group, but this leaves open the question of whether the group is conjugate to one which acts by standard isometries, the condition required to show that the manifold is homeomorphic to a spherical space form. We point out that exotic \mathbb{Z}_2 -actions on the standard sphere S^4 have been constructed in [26] and [33].

Another fundamental question is whether a Riemannian manifold satisfying the assumptions of Theorem 1.3 is diffeomorphic, instead of just homeomorphic, to S^n . This is a highly non-trivial matter as the smooth structure on S^n is not unique in general. In other words, there exist examples of so-called exotic spheres which are homeomorphic, but not diffeomorphic, to S^n . Hence, we may rephrase the problem as follows:

Conjecture 1.4. *An exotic sphere cannot admit a metric with $1/4$ -pinched sectional curvature.*

The first examples of exotic spheres were constructed in a famous paper by J. Milnor [65] in 1957. M. Kervaire and J. Milnor proved that there exist exactly 28 different smooth structures on S^7 (cf. [58]). It was shown by

E. Brieskorn that the exotic 7-spheres have a natural interpretation in terms of certain affine varieties (cf. [24], [25], [51]). To describe this result, let Σ_k denote the intersection of the affine variety

$$\{(z_1, z_2, z_3, z_4, z_5) \in \mathbb{C}^5 : z_1^2 + z_2^2 + z_3^2 + z_4^3 + z_5^{6k-1} = 0\}$$

with the unit sphere in \mathbb{C}^5 . Brieskorn proved that, for each $k \in \{1, \dots, 28\}$, Σ_k is a smooth manifold which is homeomorphic to S^7 . Moreover, the manifolds Σ_k , $k \in \{1, \dots, 28\}$, realize all the smooth structures on S^7 .

In 1974, D. Gromoll and W. Meyer [38] described an example of an exotic seven-sphere that admits a metric of nonnegative sectional curvature. It was shown by F. Wilhelm [82] that the Gromoll-Meyer sphere admits a metric which has strictly positive sectional curvature outside a set of measure zero (see also [32]). P. Petersen and F. Wilhelm have recently proposed a construction of a metric of strictly positive sectional curvature on the Gromoll-Meyer sphere, which is currently in the process of verification.

For each $n \geq 5$, the collection of all smooth structures on S^n has the structure of a finite group Θ_n , called the Kervaire-Milnor group. If $n \equiv 1, 2 \pmod{8}$, there is a natural invariant $\alpha : \Theta_n \rightarrow \mathbb{Z}_2$. This invariant is described in detail in [57]. In particular, half of all smooth structures on S^n have non-zero α -invariant. Using the Atiyah-Singer index theorem, N. Hitchin [52] showed that an exotic sphere with non-zero α -invariant cannot admit a metric of positive scalar curvature. On the other hand, it follows from a theorem of S. Stolz [79] that every exotic sphere with vanishing α -invariant does admit a metric of positive scalar curvature.

Conjecture 1.4 is known as the Differentiable Pinching Problem. This problem has been studied by a large number of authors since the 1960s, and various partial results have been obtained. D. Gromoll [37] and E. Calabi (unpublished) showed that a simply connected Riemannian manifold which is $\delta(n)$ -pinched in the global sense is diffeomorphic to S^n . The pinching constant $\delta(n)$ depends only on the dimension, and converges to 1 as $n \rightarrow \infty$. In 1971, M. Sugimoto, K. Shiohama, and H. Karcher [80] proved an analogous theorem with a pinching constant δ independent of n ($\delta = 0.87$). The pinching constant was subsequently improved by E. Ruh [73] ($\delta = 0.80$) and by K. Grove, H. Karcher, and E. Ruh [43] ($\delta = 0.76$).

In 1975, H. Im Hof and E. Ruh proved the following theorem, which extends earlier work of Grove, Karcher, and Ruh [42], [43]:

Theorem 1.5 (H. Im Hof, E. Ruh [56]). *There exists a decreasing sequence of real numbers $\delta(n)$ with $\lim_{n \rightarrow \infty} \delta(n) = 0.68$ such that the following statement holds: if M is a compact Riemannian manifold of dimension n which is $\delta(n)$ -pinched in the global sense, then M is diffeomorphic to a spherical space form.*

E. Ruh [74] has obtained a differentiable version of the sphere theorem under a pointwise pinching condition, albeit with a pinching constant converging to 1

as $n \rightarrow \infty$. In 2007, the authors proved the Differentiable Sphere Theorem with the optimal pinching constant ($\delta = 1/4$), thereby confirming Conjecture 1.4.

Theorem 1.6 (S. Brendle, R. Schoen [22]). *Let (M, g) be a compact Riemannian manifold which is strictly $1/4$ -pinched in the pointwise sense. Then M is diffeomorphic to a spherical space form. In particular, no exotic sphere admits a metric with strictly $1/4$ -pinched sectional curvature.*

Note that Theorem 1.6 only requires a pointwise pinching condition. (In fact, we will see in the coming sections that a much weaker curvature condition suffices.) The Differentiable Sphere Theorem, proved in [22], asserts that any compact Riemannian manifold (M, g) which is strictly $1/4$ -pinched in the pointwise sense admits another Riemannian metric which has constant sectional curvature 1. In particular, this implies that M is diffeomorphic to a spherical space form. In dimension 2, the Differentiable Sphere Theorem reduces to the statement that a compact surface of positive Gaussian curvature is diffeomorphic to S^2 or $\mathbb{R}P^2$. (In dimension 2, there is only one sectional curvature at each point; hence, every two-dimensional surface of positive curvature is $1/4$ -pinched in the pointwise sense.)

For weakly $1/4$ -pinched manifolds we have the following result.

Theorem 1.7 (S. Brendle, R. Schoen [21]). *Let (M, g) be a compact Riemannian manifold which is weakly $1/4$ -pinched in the pointwise sense. Then either M is diffeomorphic to a spherical space form or M is isometric to a locally CROSS manifold.*

2. Methods of Studying Positive Curvature

The proof of Theorem 1.3 relies on comparison methods which involve the study of geodesics and the influence of positive curvature which causes focusing of nearby geodesics. This made possible delicate theorems which compare triangle measurements in a variable curvature manifold to related measurements in the standard sphere. These methods also employ the variational theory of geodesics and the study of their Morse index; that is, the number of negative eigenvalues of the index form

$$I(V, V) = \int_{\gamma} (|D_{\gamma'} V|^2 - R(\gamma', V, \gamma', V)) ds$$

where γ is a geodesic and V , a normal vector field along γ which is required to vanish at the endpoints if γ is not closed. The comparison methods were employed in more powerful ways later in the work of Grove and Shiohama [44] on their diameter sphere theorem. This led soon after to the following result of Gromov.

Theorem 2.1 (M. Gromov [39]). *There is a constant C depending only on the dimension n such that the Betti numbers of any compact n -manifold of nonnegative curvature are bounded by C .*

New methods were introduced into the study of positive curvature by Micallef and Moore [64]. Through the study of the variational theory of minimal two spheres immersed in M they were able to weaken the curvature assumptions in the Topological Sphere Theorem. To that end, Micallef and Moore introduced a novel curvature condition, which they called positive isotropic curvature.

Definition 2.2. Let (M, g) be a Riemannian manifold of dimension $n \geq 4$. We say that (M, g) has nonnegative isotropic curvature if

$$R(e_1, e_3, e_1, e_3) + R(e_1, e_4, e_1, e_4) + R(e_2, e_3, e_2, e_3) \\ + R(e_2, e_4, e_2, e_4) - 2R(e_1, e_2, e_3, e_4) \geq 0$$

for all points $p \in M$ and all orthonormal four-frames $\{e_1, e_2, e_3, e_4\} \subset T_p M$. Moreover, if the strict inequality holds, we say that (M, g) has positive isotropic curvature.

For each point $p \in M$, we denote by $T_p^{\mathbb{C}} M = TM \otimes_{\mathbb{R}} \mathbb{C}$ the complexified tangent space to M at p . The Riemannian metric g extends to a complex bilinear form $g : T_p^{\mathbb{C}} M \times T_p^{\mathbb{C}} M \rightarrow \mathbb{C}$. Similarly, the Riemann curvature tensor extends to a complex multilinear form $R : T_p^{\mathbb{C}} M \times T_p^{\mathbb{C}} M \times T_p^{\mathbb{C}} M \times T_p^{\mathbb{C}} M \rightarrow \mathbb{C}$.

Proposition 2.3. *The manifold (M, g) has nonnegative isotropic curvature if and only if $R(\zeta, \eta, \bar{\zeta}, \bar{\eta}) \geq 0$ for all points $p \in M$ and all vectors $\zeta, \eta \in T_p^{\mathbb{C}} M$ satisfying $g(\zeta, \zeta) = g(\eta, \eta) = 0$.*

The key idea of Micallef and Moore is to study harmonic (or equivalently minimal) two-spheres instead of geodesics. More precisely, for each map $f : S^2 \rightarrow M$, the energy of f is defined by

$$\mathcal{E}(f) = \frac{1}{2} \int_{S^2} \left(\left| \frac{\partial f}{\partial x} \right|^2 + \left| \frac{\partial f}{\partial y} \right|^2 \right) dx dy,$$

where (x, y) are the coordinates on S^2 obtained by stereographic projection. A map $f : S^2 \rightarrow M$ is called harmonic if it is a critical point of the functional $\mathcal{E}(f)$. This is equivalent to saying that

$$D_{\frac{\partial}{\partial x}} \frac{\partial f}{\partial x} + D_{\frac{\partial}{\partial y}} \frac{\partial f}{\partial y} = 0$$

at each point on S^2 . In the special case when (M, g) has positive isotropic curvature, Micallef and Moore obtained a lower bound for the Morse index of harmonic two-spheres.

Proposition 2.4 (M. Micalef, J.D. Moore [64]). *Let (M, g) be a compact Riemannian manifold of dimension $n \geq 4$ with positive isotropic curvature, and let $f : S^2 \rightarrow M$ be a nonconstant harmonic map. Then f has Morse index at least $\lfloor \frac{n-2}{2} \rfloor$.*

The key idea in the proof is to consider complex variations W of the map and to observe that the index form can be written

$$I(W, \overline{W}) = 4 \int_{S^2} g(D_{\frac{\partial}{\partial \bar{z}}} W, D_{\frac{\partial}{\partial z}} \overline{W}) dx dy - 4 \int_{S^2} R\left(\frac{\partial f}{\partial z}, W, \frac{\partial f}{\partial \bar{z}}, \overline{W}\right) dx dy.$$

It is then shown, by use of the Riemann-Roch theorem, that the dimension of the space of holomorphic and isotropic variations is at least $\lfloor \frac{n-2}{2} \rfloor$, and this leads to the Morse index bound.

Combining Proposition 2.4 with the variational theory for harmonic maps (see e.g. [75], Chapter VII), Micalef and Moore were able to draw the following conclusion.

Theorem 2.5 (M. Micalef, J.D. Moore [64]). *Let (M, g) be a compact, simply connected Riemannian manifold of dimension $n \geq 4$ with positive isotropic curvature. Then M is homeomorphic to S^n .*

Sketch of the proof of Theorem 2.5. The idea is to study the homotopy groups of M . If $\pi_k(M) \neq 0$ for some $k \in \{2, \dots, \lfloor \frac{n}{2} \rfloor\}$, then the variational theory for harmonic maps implies that there exists a nonconstant harmonic map $f : S^2 \rightarrow M$ with Morse index at most $k - 2$. On the other hand, any nonconstant harmonic map from S^2 into M has Morse index at least $\lfloor \frac{n-2}{2} \rfloor$ by Proposition 2.4. This is a contradiction.

Therefore, we have $\pi_k(M) = 0$ for $k = 2, \dots, \lfloor \frac{n}{2} \rfloor$. Since M is assumed to be simply connected, it follows that $H_k(M, \mathbb{Z}) = 0$ for $k = 1, \dots, \lfloor \frac{n}{2} \rfloor$. Using Poincaré duality, it follows that $H_k(M, \mathbb{Z}) = 0$ for $k = 1, \dots, n - 1$. This shows that M is a homotopy sphere. Hence, it follows from results of Freedman [35] and Smale [78] that M is homeomorphic to S^n . \square

We note that any manifold (M, g) which is strictly $1/4$ -pinched in the pointwise sense has positive isotropic curvature. Hence, Theorem 2.5 generalizes the Topological Sphere Theorem of Berger and Klingenberg. The following result provides some information about fundamental groups of manifolds with positive isotropic curvature.

Theorem 2.6 (A. Fraser [34]). *Let M be a compact Riemannian manifold of dimension $n \geq 5$ with positive isotropic curvature. Then the fundamental group of M does not contain a subgroup isomorphic to $\mathbb{Z} \oplus \mathbb{Z}$.*

The proof of Theorem 2.6 relies on a delicate analysis of stable minimal tori. This result was proved in dimension $n \geq 5$ by A. Fraser [34]. In [23], the

authors extended Fraser's theorem to the four-dimensional case. The topology of manifolds with positive isotropic curvature is also studied in [36].

Finally we introduce the Ricci flow approach to positive curvature. This technique was introduced in seminal work of R. Hamilton in the 1980s (see e.g. [46], [47]). The fundamental idea is to start with a given Riemannian manifold (M, g_0) , and evolve the metric by the evolution equation

$$\frac{\partial}{\partial t} g(t) = -2 \operatorname{Ric}_{g(t)}, \quad g(0) = g_0.$$

Here, $\operatorname{Ric}_{g(t)}$ denotes the Ricci tensor of the time-dependent metric $g(t)$.

Hamilton [46] proved that the Ricci flow always has a solution on some maximal time interval $[0, T)$, where $T > 0$ (see also [30]). Furthermore, if $T < \infty$, then the Riemann curvature tensor of $(M, g(t))$ must be unbounded, so that $\limsup_{t \rightarrow T} \sup_M |R_{g(t)}| = \infty$. This result was later improved by N. Šešum [77] who showed that $\limsup_{t \rightarrow T} \sup_M |\operatorname{Ric}_{g(t)}| = \infty$ if $T < \infty$.

As pointed out above, the Ricci flow is a nonlinear heat equation for Riemannian metrics. This becomes apparent when we consider the evolution of the curvature tensor of $g(t)$. The Riemann curvature tensor satisfies an evolution equation of the form

$$\frac{\partial}{\partial t} R = \Delta R + \text{quadratic terms in } R,$$

where Δ denotes the Laplace operator associated with the time-dependent metric $g(t)$. The exact form of the quadratic terms will become important later on.

As an example, suppose that g_0 is the standard metric on S^n with constant sectional curvature 1. In this case, the metrics $g(t) = (1 - 2(n-1)t)g_0$ form a solution to the Ricci flow. This solution is defined for all $t \in [0, \frac{1}{2(n-1)})$, and collapses to a point as $t \rightarrow \frac{1}{2(n-1)}$.

In dimension 3, Hamilton showed that the Ricci flow deforms any initial metric with positive Ricci curvature to a constant curvature metric.

Theorem 2.7 (R. Hamilton [46]). *Let (M, g_0) be a compact three-manifold with positive Ricci curvature. Moreover, let $g(t)$, $t \in [0, T)$, denote the unique maximal solution to the Ricci flow with initial metric g_0 . Then the rescaled metrics $\frac{1}{4(T-t)} g(t)$ converge to a metric of constant sectional curvature 1 as $t \rightarrow T$.*

The proof of Theorem 2.7 relies on pointwise curvature estimates. These are established using a suitable version of the maximum principle for tensors.

Theorem 2.7 has important topological implications. It implies that any compact three-manifold with positive Ricci curvature is diffeomorphic to a spherical space form. Using the classification of spherical space forms in [83], Hamilton was able to give a complete classification of all compact three-manifolds that admit metrics of positive Ricci curvature.

Hamilton's convergence theorem in dimension 3 has inspired a large body of work over the last 25 years. In particular, two lines of research have been pursued:

First, one would like to study the global behavior of the Ricci flow in dimension 3 for general initial metrics (i.e. without the assumption of positive Ricci curvature). This line of research was pioneered by Hamilton, who developed many crucial technical tools (see e.g. [48], [49]). It culminated in Perelman's proof of the Poincaré and Geometrization conjectures (cf. [68], [69], [70]). A non-technical survey can be found in [14] or [60].

Another natural problem is to extend the convergence theory for the Ricci flow to dimensions greater than 3. In this case, one assumes that the initial metric satisfies a suitable curvature condition. The goal is to show that the evolved metrics converge to a metric of constant sectional curvature up to rescaling. One of the first results in this direction was established by Hamilton [47] in 1986.

Theorem 2.8 (R. Hamilton [47]). *Let (M, g_0) be a compact Riemannian manifold of dimension 4. Assume that g_0 has positive curvature operator; that is, $\sum_{i,j,k,l} R_{ijkl} \varphi^{ij} \varphi^{kl} > 0$ for each point $p \in M$ and every non-zero two-form $\varphi \in \wedge^2 T_p M$. Moreover, let $g(t)$, $t \in [0, T)$, denote the unique maximal solution to the Ricci flow with initial metric g_0 . Then the rescaled metrics $\frac{1}{6(T-t)} g(t)$ converge to a metric of constant sectional curvature 1 as $t \rightarrow T$.*

Again, Theorem 2.8 has a topological corollary: it implies that any compact four-manifold which admits a metric of positive curvature operator is diffeomorphic to S^4 or $\mathbb{R}P^4$.

H. Chen [29] proved that the conclusion of Theorem 2.8 holds under a slightly weaker curvature assumption. A Riemannian manifold M is said to have two-positive curvature operator if $\sum_{i,j,k,l} R_{ijkl} (\varphi^{ij} \varphi^{kl} + \psi^{ij} \psi^{kl}) > 0$ for all points $p \in M$ and all two-forms $\varphi, \psi \in \wedge^2 T_p M$ satisfying $|\varphi|^2 = |\psi|^2 = 1$ and $\langle \varphi, \psi \rangle = 0$. Furthermore, Chen [29] proved that every four-manifold which is strictly 1/4-pinched in the pointwise sense has two-positive curvature operator. This is a special feature of the four-dimensional case, which fails in dimension $n \geq 5$. As a consequence, Chen was able to show that every compact four-manifold, which is strictly 1/4-pinched in the pointwise sense, is diffeomorphic to S^4 or $\mathbb{R}P^4$. B. Andrews and H. Nguyen [3] have recently obtained an alternative proof of this result.

We note that C. Margerin [62] proved a sharp convergence result for the Ricci flow in dimension 4. Combining this theorem with techniques from conformal geometry, A. Chang, M. Gursky, and P. Yang proved a beautiful conformally invariant sphere theorem in dimension 4:

Theorem 2.9 (A. Chang, M. Gursky, P. Yang [27]). *Let (M, g) be a compact four-manifold with positive Yamabe constant. Suppose that (M, g) satisfies the*

integral pinching condition

$$\int_M |W|^2 d\text{vol} < 16\pi^2 \chi(M),$$

where $|W|^2 = \sum_{i,j,k,l} W_{ijkl} W^{ijkl}$ denotes the square of the norm of the Weyl tensor of (M, g) . Then M is either diffeomorphic to S^4 or $\mathbb{R}P^4$.

The key step in the proof is to construct a conformal metric $\tilde{g} = e^{2w} g$ which has positive scalar curvature and satisfies the pointwise inequality

$$\frac{1}{6} \text{scal}_{\tilde{g}}^2 - 2 |\overset{\circ}{\text{Ric}}_{\tilde{g}}|^2 - |W_{\tilde{g}}|^2 > 0.$$

Having constructed a metric \tilde{g} with these properties, a theorem of C. Margerin [62] implies that the Ricci flow evolves the metric \tilde{g} to a constant curvature metric. This shows that M is diffeomorphic to either S^4 or $\mathbb{R}P^4$.

The first convergence result in arbitrary dimension was proved by G. Huisken [55] in 1985.

Theorem 2.10 (G. Huisken [55]). *Assume that (M, g_0) is a compact manifold of dimension $n \geq 4$. If (M, g_0) is $\delta(n)$ -pinched in the pointwise sense, then the Ricci flow converges to a metric of constant curvature 1 up to rescaling. Here, $\delta(n) \in (0, 1)$ is an explicit constant that depends only on n .*

We note that C. Margerin [61] and S. Nishikawa [67] have also obtained convergence results for the Ricci flow in arbitrary dimension. By introducing new methods into the study of the curvature ODE, Böhm and Wilking were able to extend Chen's theorem to higher dimensions.

Theorem 2.11 (C. Böhm, B. Wilking [16]). *If (M, g_0) is a compact manifold with two-positive curvature operator, then the Ricci flow converges to a metric of constant curvature 1 up to rescaling.*

3. Proofs of the Main Theorems

All known convergence theorems for the Ricci flow share some common features. In particular, they all exploit the fact that a certain curvature condition is preserved by the Ricci flow. To begin this section, we describe some general tools for verifying that a given curvature condition is preserved by the Ricci flow. These tools are based on the maximum principle, and were developed by Hamilton [46], [47].

Let $g(t)$, $t \in [0, T)$, be a solution to the Ricci flow on a manifold M . Moreover, let E denote the pull-back of the tangent bundle TM under the map

$$M \times (0, T) \rightarrow M, \quad (p, t) \mapsto p.$$

Clearly, E is a vector bundle over $M \times (0, T)$, and the fiber of E over the point $(p, t) \in M \times (0, T)$ is given by the tangent space $T_p M$. The sections of the vector bundle E can be viewed as vector fields on M that vary in time. Given any section X of E , we define the covariant time derivative of X by

$$D_{\frac{\partial}{\partial t}} X = \frac{\partial}{\partial t} X - \sum_{k=1}^n \text{Ric}(X, e_k) e_k,$$

where $\{e_1, \dots, e_n\}$ is a local orthonormal frame with respect to the metric $g(t)$. The covariant time derivative $D_{\frac{\partial}{\partial t}}$ is metric compatible in the sense that

$$\begin{aligned} \frac{\partial}{\partial t}(g(X, Y)) &= g\left(\frac{\partial}{\partial t} X, Y\right) + g\left(X, \frac{\partial}{\partial t} Y\right) - 2 \text{Ric}(X, Y) \\ &= g\left(D_{\frac{\partial}{\partial t}} X, Y\right) + g\left(X, D_{\frac{\partial}{\partial t}} Y\right) \end{aligned}$$

for all sections X, Y of the bundle E .

The Riemann curvature tensor of $g(t)$ can now be viewed as a section of the bundle $E^* \otimes E^* \otimes E^* \otimes E^*$. Furthermore, the covariant time derivative on E induces a covariant time derivative on the bundle $E^* \otimes E^* \otimes E^* \otimes E^*$. With this understood, the evolution equation of the Riemann curvature tensor can be written in the form

$$D_{\frac{\partial}{\partial t}} R = \Delta R + Q(R),$$

where $Q(R)$ denotes the following quadratic expression in R :

$$\begin{aligned} Q(R)(X, Y, Z, W) &= \sum_{p, q=1}^n R(X, Y, e_p, e_q) R(Z, W, e_p, e_q) \\ &\quad + 2 \sum_{p, q=1}^n R(X, e_p, Z, e_q) R(Y, e_p, W, e_q) \\ &\quad - 2 \sum_{p, q=1}^n R(X, e_p, W, e_q) R(Y, e_p, Z, e_q). \end{aligned} \quad (3)$$

This evolution equation was first derived by Hamilton [47]; see also [20], Section 2.3.

We next describe Hamilton's maximum principle for the Ricci flow. To fix notation, let $\mathcal{C}_B(\mathbb{R}^n)$ denote the space of all algebraic curvature operators on \mathbb{R}^n . In other words, $\mathcal{C}_B(\mathbb{R}^n)$ consists of all multilinear forms $R : \mathbb{R}^n \times \mathbb{R}^n \times \mathbb{R}^n \times \mathbb{R}^n \rightarrow \mathbb{R}$ satisfying the relations

$$R(X, Y, Z, W) = -R(Y, X, Z, W) = R(Z, W, X, Y)$$

and

$$R(X, Y, Z, W) + R(Y, Z, X, W) + R(Z, X, Y, W) = 0$$

for all vectors $X, Y, Z, W \in \mathbb{R}^n$. Moreover, let F be a subset of $\mathcal{C}_B(\mathbb{R}^n)$ which is invariant under the natural action of $O(n)$. Since F is $O(n)$ -invariant, it makes sense to say that the curvature tensor of a Riemannian manifold (M, g) lies in the set F . To explain this, we fix a point $p \in M$. After identifying the tangent space $T_p M$ with \mathbb{R}^n , we may view the curvature tensor of (M, g) at p as an element of $\mathcal{C}_B(\mathbb{R}^n)$. Of course, the identification of $T_p M$ with \mathbb{R}^n is not canonical, but this does not cause problems since F is $O(n)$ -invariant.

Theorem 3.1 (R. Hamilton [47]). *Let $F \subset \mathcal{C}_B(\mathbb{R}^n)$ be a closed, convex set which is invariant under the natural action of $O(n)$. Moreover, we assume that F is invariant under the ODE $\frac{d}{dt}R = Q(R)$. Finally, let $g(t)$, $t \in [0, T)$, be a solution to the Ricci flow on a compact manifold M with the property that the curvature tensor of $(M, g(0))$ lies in F for all points $p \in M$. Then the curvature tensor of $(M, g(t))$ lies in F for all points $p \in M$ and all $t \in [0, T)$.*

In the remainder of this section, we discuss some important examples of curvature conditions that are preserved by the Ricci flow. Hamilton [47] proved that nonnegative curvature operator is preserved in all dimensions. Furthermore, Hamilton showed that nonnegative Ricci curvature is preserved by the Ricci flow in dimension 3, and nonnegative isotropic curvature is preserved in dimension 4 (see [46], [50]). It turns out that nonnegative Ricci curvature is not preserved by the Ricci flow in dimension $n \geq 4$ (see [63]). By contrast, nonnegative isotropic curvature is preserved by the Ricci flow in all dimensions.

Theorem 3.2 (S. Brendle, R. Schoen [22]; H. Nguyen [66]). *Let M be a compact manifold of dimension $n \geq 4$, and let $g(t)$, $t \in [0, T)$, be a solution to the Ricci flow on M . If $(M, g(0))$ has nonnegative isotropic curvature, then $(M, g(t))$ has nonnegative isotropic curvature for all $t \in [0, T)$.*

The proof of Theorem 3.2 requires two ingredients: the first is Hamilton's maximum principle for the Ricci flow (cf. Theorem 3.1); the second one is an algebraic inequality for curvature tensors with nonnegative isotropic curvature. We give a sketch of the proof here. A complete proof can be found in [20], Sections 7.2 and 7.3.

Proposition 3.3. *Let R be an algebraic curvature tensor on \mathbb{R}^n with nonnegative isotropic curvature. Moreover, suppose that*

$$R_{1313} + R_{1414} + R_{2323} + R_{2424} - 2R_{1234} = 0$$

for some orthonormal four-frame $\{e_1, e_2, e_3, e_4\}$. Then

$$Q(R)_{1313} + Q(R)_{1414} + Q(R)_{2323} + Q(R)_{2424} - 2Q(R)_{1234} \geq 0.$$

Sketch of the proof of Proposition 3.3. Using the definition of $Q(R)$, we compute

$$\begin{aligned}
 & Q(R)_{1313} + Q(R)_{1414} + Q(R)_{2323} + Q(R)_{2424} - 2Q(R)_{1234} \\
 &= \sum_{p,q=1}^n (R_{13pq} - R_{24pq})^2 + \sum_{p,q=1}^n (R_{14pq} + R_{23pq})^2 \\
 &+ 2 \sum_{p,q=1}^n (R_{1p1q} + R_{2p2q})(R_{3p3q} + R_{4p4q}) - 2 \sum_{p,q=1}^n R_{12pq} R_{34pq} \\
 &- 2 \sum_{p,q=1}^n (R_{1p3q} + R_{2p4q})(R_{3p1q} + R_{4p2q}) \\
 &- 2 \sum_{p,q=1}^n (R_{1p4q} - R_{2p3q})(R_{4p1q} - R_{3p2q}).
 \end{aligned}$$

Hence, it suffices to prove that

$$\begin{aligned}
 & \sum_{p,q=1}^n (R_{1p1q} + R_{2p2q})(R_{3p3q} + R_{4p4q}) - \sum_{p,q=1}^n R_{12pq} R_{34pq} \\
 & \geq \sum_{p,q=1}^n (R_{1p3q} + R_{2p4q})(R_{3p1q} + R_{4p2q}) \\
 & + \sum_{p,q=1}^n (R_{1p4q} - R_{2p3q})(R_{4p1q} - R_{3p2q}).
 \end{aligned} \tag{4}$$

In order to prove (4), we view the isotropic curvature as a real-valued function defined on the space of all orthonormal four-frames. By assumption, this function attains its global minimum at the point $\{e_1, e_2, e_3, e_4\}$. Hence, the first variation at the point $\{e_1, e_2, e_3, e_4\}$ is zero, and the second variation is nonnegative. In order to take advantage of this information, we consider three different types of variations:

Step 1: We first consider the orthonormal four-frame $\{e_1, \cos(s)e_2 - \sin(s)e_3, \sin(s)e_2 + \cos(s)e_3, e_4\}$. Since the first variation of the isotropic curvature is zero, we have $R_{1213} + R_{1242} + R_{3413} + R_{3442} = 0$. An analogous argument gives $R_{1214} + R_{1223} + R_{3414} + R_{3423} = 0$. Using these identities, one can show that

$$\begin{aligned}
 & \sum_{p,q=1}^4 (R_{1p1q} + R_{2p2q})(R_{3p3q} + R_{4p4q}) - \sum_{p,q=1}^4 R_{12pq} R_{34pq} \\
 &= \sum_{p,q=1}^4 (R_{1p3q} + R_{2p4q})(R_{3p1q} + R_{4p2q}) \\
 &+ \sum_{p,q=1}^4 (R_{1p4q} - R_{2p3q})(R_{4p1q} - R_{3p2q}).
 \end{aligned} \tag{5}$$

Step 2: We next consider the four-frame $\{\cos(s)e_1 + \sin(s)e_q, e_2, e_3, e_4\}$, where $q \in \{5, \dots, n\}$. Since the first variation of the isotropic curvature is equal to zero, it follows that $R_{133q} + R_{144q} + R_{432q} = 0$. Using this and other analogous identities, we obtain

$$\begin{aligned} & \sum_{p=1}^4 (R_{1p1q} + R_{2p2q}) (R_{3p3q} + R_{4p4q}) - \sum_{p=1}^4 R_{12pq} R_{34pq} \\ &= \sum_{p=1}^4 (R_{1p3q} + R_{2p4q}) (R_{3p1q} + R_{4p2q}) \\ &+ \sum_{p=1}^4 (R_{1p4q} - R_{2p3q}) (R_{4p1q} - R_{3p2q}) \end{aligned} \quad (6)$$

for $q = 5, \dots, n$.

Step 3: To describe the third type of variation, we consider four vectors $w_1, w_2, w_3, w_4 \in \text{span}\{e_5, \dots, e_n\}$. For each $i \in \{1, 2, 3, 4\}$, we denote by $v_i(s)$ the unique solution of the linear ODE

$$v_i'(s) = \sum_{j=1}^4 (\langle v_i(s), e_j \rangle w_j - \langle v_i(s), w_j \rangle e_j)$$

with initial condition $v_i(0) = e_i$. Then $v_i'(0) = w_i$. Moreover, it is easy to see that the vectors $\{v_1(s), v_2(s), v_3(s), v_4(s)\}$ are orthonormal for all $s \in \mathbb{R}$. Since the second variation of the isotropic curvature is nonnegative, we conclude that

$$\begin{aligned} 0 &\leq R(w_1, e_3, w_1, e_3) + R(w_1, e_4, w_1, e_4) \\ &+ R(w_2, e_3, w_2, e_3) + R(w_2, e_4, w_2, e_4) \\ &+ R(e_1, w_3, e_1, w_3) + R(e_2, w_3, e_2, w_3) \\ &+ R(e_1, w_4, e_1, w_4) + R(e_2, w_4, e_2, w_4) \\ &- 2 [R(e_3, w_1, e_1, w_3) + R(e_4, w_1, e_2, w_3)] \\ &- 2 [R(e_4, w_1, e_1, w_4) - R(e_3, w_1, e_2, w_4)] \\ &+ 2 [R(e_4, w_2, e_1, w_3) - R(e_3, w_2, e_2, w_3)] \\ &- 2 [R(e_3, w_2, e_1, w_4) + R(e_4, w_2, e_2, w_4)] \\ &- 2 R(w_1, w_2, e_3, e_4) - 2 R(e_1, e_2, w_3, w_4) \end{aligned} \quad (7)$$

for all vectors $w_1, w_2, w_3, w_4 \in \text{span}\{e_5, \dots, e_n\}$. We next define linear transformations $A, B, C, D, E, F : \text{span}\{e_5, \dots, e_n\} \rightarrow \text{span}\{e_5, \dots, e_n\}$ by

$$\begin{aligned} \langle Ae_p, e_q \rangle &= R_{1p1q} + R_{2p2q}, & \langle Be_p, e_q \rangle &= R_{3p3q} + R_{4p4q}, \\ \langle Ce_p, e_q \rangle &= R_{3p1q} + R_{4p2q}, & \langle De_p, e_q \rangle &= R_{4p1q} - R_{3p2q}, \\ \langle Ee_p, e_q \rangle &= R_{12pq}, & \langle Fe_p, e_q \rangle &= R_{34pq} \end{aligned}$$

for $p, q \in \{5, \dots, n\}$. The inequality (7) implies that the symmetric operator

$$\begin{bmatrix} B & F & -C^* & -D^* \\ -F & B & D^* & -C^* \\ -C & D & A & E \\ -D & -C & -E & A \end{bmatrix}$$

is positive semi-definite. From this, we deduce that $\text{tr}(AB) + \text{tr}(EF) \geq \text{tr}(C^2) + \text{tr}(D^2)$, hence

$$\begin{aligned} & \sum_{p,q=5}^n (R_{1p1q} + R_{2p2q})(R_{3p3q} + R_{4p4q}) - \sum_{p,q=5}^n R_{12pq} R_{34pq} \\ & \geq \sum_{p,q=5}^n (R_{1p3q} + R_{2p4q})(R_{3p1q} + R_{4p2q}) \\ & + \sum_{p,q=5}^n (R_{1p4q} - R_{2p3q})(R_{4p1q} - R_{3p2q}). \end{aligned} \tag{8}$$

Combining (5), (6), and (8), the inequality (4) follows. □

We next describe various curvature conditions that are related to nonnegative isotropic curvature, and are also preserved by the Ricci flow. The following is an immediate consequence of Theorem 3.2.

Corollary 3.4 (S. Brendle, R. Schoen [22]). *Let M be a compact manifold of dimension $n \geq 4$, and let $g(t)$, $t \in [0, T]$, be a solution to the Ricci flow on M . Then:*

- *If $(M, g(0)) \times \mathbb{R}$ has nonnegative isotropic curvature, then the product $(M, g(t)) \times \mathbb{R}$ has nonnegative isotropic curvature for all $t \in [0, T]$.*
- *If $(M, g(0)) \times \mathbb{R}^2$ has nonnegative isotropic curvature, then the product $(M, g(t)) \times \mathbb{R}^2$ has nonnegative isotropic curvature for all $t \in [0, T]$.*

Another result in this direction was proved by the first author in [18] (see also [20], Section 7.6). In the following, $S^2(1)$ denotes a two-dimensional sphere of constant curvature 1.

Theorem 3.5 (S. Brendle [18]). *Let M be a compact manifold of dimension $n \geq 4$, and let $g(t)$, $t \in [0, T]$, be a solution to the Ricci flow on M . If $(M, g(0)) \times S^2(1)$ has nonnegative isotropic curvature, then $(M, g(t)) \times S^2(1)$ has nonnegative isotropic curvature for all $t \in [0, T]$.*

Unlike Corollary 3.4, Theorem 3.5 does not follow directly from Theorem 3.2. This is because the manifolds $(M, g(t)) \times S^2(1)$ do not form a solution to the Ricci flow.

We now discuss the product conditions in more detail. To that end, we assume that (M, g) is a Riemannian manifold of dimension n . We first consider the case $n = 3$. In this case, the following holds:

- The product $(M, g) \times \mathbb{R}$ has nonnegative isotropic curvature if and only if (M, g) has nonnegative Ricci curvature.
- The product $(M, g) \times \mathbb{R}^2$ has nonnegative isotropic curvature if and only if (M, g) has nonnegative sectional curvature.

We now return to the case $n \geq 4$. The following proposition gives a necessary and sufficient condition for the product $(M, g) \times \mathbb{R}$ to have nonnegative isotropic curvature.

Proposition 3.6. *Let (M, g) be a Riemannian manifold of dimension $n \geq 4$. Then the following statements are equivalent:*

- (i) *The product $(M, g) \times \mathbb{R}$ has nonnegative isotropic curvature.*
- (ii) *We have*

$$\begin{aligned} &R(e_1, e_3, e_1, e_3) + \lambda^2 R(e_1, e_4, e_1, e_4) \\ &+ R(e_2, e_3, e_2, e_3) + \lambda^2 R(e_2, e_4, e_2, e_4) \\ &- 2\lambda R(e_1, e_2, e_3, e_4) \geq 0 \end{aligned}$$

for all points $p \in M$, all orthonormal four-frames $\{e_1, e_2, e_3, e_4\} \subset T_p M$, and all $\lambda \in [0, 1]$.

- (iii) *We have $R(\zeta, \eta, \bar{\zeta}, \bar{\eta}) \geq 0$ for all points $p \in M$ and all vectors $\zeta, \eta \in T_p^{\mathbb{C}} M$ satisfying $g(\zeta, \zeta)g(\eta, \eta) - g(\zeta, \eta)^2 = 0$.*

The proof of Proposition 3.6 is purely algebraic (for details, see [20], Proposition 7.18). We next consider the condition that $(M, g) \times \mathbb{R}^2$ has nonnegative isotropic curvature (cf. [20], Proposition 7.18).

Proposition 3.7. *Let (M, g) be a Riemannian manifold of dimension $n \geq 4$. Then the following statements are equivalent:*

- (i) *The product $(M, g) \times \mathbb{R}^2$ has nonnegative isotropic curvature.*
- (ii) *We have*

$$\begin{aligned} &R(e_1, e_3, e_1, e_3) + \lambda^2 R(e_1, e_4, e_1, e_4) \\ &+ \mu^2 R(e_2, e_3, e_2, e_3) + \lambda^2 \mu^2 R(e_2, e_4, e_2, e_4) \\ &- 2\lambda\mu R(e_1, e_2, e_3, e_4) \geq 0 \end{aligned}$$

for all points $p \in M$, all orthonormal four-frames $\{e_1, e_2, e_3, e_4\} \subset T_p M$, and all $\lambda, \mu \in [0, 1]$.

(iii) We have $R(\zeta, \eta, \bar{\zeta}, \bar{\eta}) \geq 0$ for all points $p \in M$ and all vectors $\zeta, \eta \in T_p^{\mathbb{C}} M$.

Theorem 3.2 and Corollary 3.4 provide important examples of preserved curvature conditions. Each of these curvature conditions defines a closed, convex, $O(n)$ -invariant cone in $\mathcal{C}_B(\mathbb{R}^n)$, which is preserved by the Hamilton ODE. By adapting a technique of Böhm and Wilking [16], it is possible to construct a family of so-called pinching cones, which are all preserved by the Hamilton ODE. Combining these ideas with general results of R. Hamilton (see [47] or [20], Section 5.4), one can draw the following conclusion.

Theorem 3.8 (S. Brendle, R. Schoen [22]). *Let (M, g_0) be a compact Riemannian manifold of dimension $n \geq 4$ with the property that*

$$\begin{aligned} &R(e_1, e_3, e_1, e_3) + \lambda^2 R(e_1, e_4, e_1, e_4) \\ &+ \mu^2 R(e_2, e_3, e_2, e_3) + \lambda^2 \mu^2 R(e_2, e_4, e_2, e_4) \\ &- 2\lambda\mu R(e_1, e_2, e_3, e_4) > 0 \end{aligned}$$

for all orthonormal four-frames $\{e_1, e_2, e_3, e_4\}$ and all $\lambda, \mu \in [0, 1]$. Let $g(t)$, $t \in [0, T)$, denote the unique maximal solution to the Ricci flow with initial metric g_0 . Then the rescaled metrics $\frac{1}{2(n-1)(T-t)} g(t)$ converge to a metric of constant sectional curvature 1 as $t \rightarrow T$.

It turns out that any Riemannian manifold of dimension $n \geq 4$ which is strictly 1/4-pinched in the pointwise sense satisfies the assumption of Theorem 3.8. Hence, we can draw the following conclusion.

Corollary 3.9 (S. Brendle, R. Schoen [22]). *Let (M, g_0) be a compact Riemannian manifold of dimension $n \geq 4$ which is strictly 1/4-pinched in the pointwise sense. Let $g(t)$, $t \in [0, T)$, denote the unique maximal solution to the Ricci flow with initial metric g_0 . Then the rescaled metrics $\frac{1}{2(n-1)(T-t)} g(t)$ converge to a metric of constant sectional curvature 1 as $t \rightarrow T$.*

The Differentiable Sphere Theorem (Theorem 1.6 above) is an immediate consequence of Corollary 3.9. To conclude this section, we state an improved convergence result for the Ricci flow.

Theorem 3.10 (S. Brendle [18]). *Let (M, g_0) be a compact Riemannian manifold of dimension $n \geq 4$ with the property that*

$$\begin{aligned} &R(e_1, e_3, e_1, e_3) + \lambda^2 R(e_1, e_4, e_1, e_4) \\ &+ R(e_2, e_3, e_2, e_3) + \lambda^2 R(e_2, e_4, e_2, e_4) \\ &- 2\lambda R(e_1, e_2, e_3, e_4) > 0 \end{aligned}$$

for all orthonormal four-frames $\{e_1, e_2, e_3, e_4\}$ and all $\lambda \in [0, 1]$. Let $g(t)$, $t \in [0, T)$, denote the unique maximal solution to the Ricci flow with initial metric g_0 . Then the rescaled metrics $\frac{1}{2(n-1)(T-t)} g(t)$ converge to a metric of constant sectional curvature 1 as $t \rightarrow T$.

Theorem 3.10 extends many known convergence results for the Ricci flow (see also [15]). The main ingredient in the proof is Theorem 3.5. A detailed argument can be found in [20], Section 8.4.

4. Weak Pinching and Further Developments

In this section, we describe various rigidity theorems and results which weaken the $1/4$ -pinching assumption. For a detailed exposition of the rigidity results, we refer to [20], Chapter 9. We close by outlining some open problems and conjectures in this area.

The first result in this direction was established by M. Berger [9] (see also [28], Theorem 6.6).

Theorem 4.1 (M. Berger [9]). *Let (M, g) be a compact, simply connected Riemannian manifold which is weakly $1/4$ -pinched in the global sense. Then M is either homeomorphic to S^n or isometric to a symmetric space.*

We now describe some rigidity results obtained by means of the Ricci flow. The following result was established by R. Hamilton:

Theorem 4.2 (R. Hamilton [47]). *Let (M, g_0) be a compact three-manifold which is locally irreducible and has nonnegative Ricci curvature. Moreover, let $g(t)$, $t \in [0, T)$, denote the unique maximal solution to the Ricci flow with initial metric g_0 . Then the rescaled metrics $\frac{1}{4(T-t)} g(t)$ converge to a metric of constant sectional curvature 1 as $t \rightarrow T$.*

In dimension $n \geq 4$, we have the following result:

Theorem 4.3 (S. Brendle, R. Schoen [21]). *Let M be a compact manifold of dimension $n \geq 4$, and let $g(t)$, $t \in [0, T]$ be a solution to the Ricci flow on M with nonnegative isotropic curvature. Then, for each $\tau \in (0, T)$, the set of all orthonormal four-frames $\{e_1, e_2, e_3, e_4\}$ satisfying*

$$\begin{aligned} &R_{g(\tau)}(e_1, e_3, e_1, e_3) + R_{g(\tau)}(e_1, e_4, e_1, e_4) \\ &+ R_{g(\tau)}(e_2, e_3, e_2, e_3) + R_{g(\tau)}(e_2, e_4, e_2, e_4) \\ &- 2 R_{g(\tau)}(e_1, e_2, e_3, e_4) = 0 \end{aligned}$$

is invariant under parallel transport with respect to the metric $g(\tau)$.

In particular, if the reduced holonomy group of $(M, g(\tau))$ is $\mathrm{SO}(n)$, then $(M, g(\tau))$ has positive isotropic curvature.

Theorem 4.3 is similar in spirit to a result of R. Hamilton [47] concerning solutions to the Ricci flow with nonnegative curvature operator. However, Hamilton’s techniques are not applicable in this setting. Instead, the proof of Theorem 4.3 relies on a variant of J.M. Bony’s strict maximum principle for degenerate elliptic equations (cf. [17]). This technique was first employed in the context of geometric flows in [21]. It has since found applications to other borderline situations involving Ricci flow (see e.g. [3], [45]).

Theorem 4.3 is particularly effective in combination with M. Berger’s classification of holonomy groups (see [7]). For example, the following structure theorem for compact, simply connected manifolds with nonnegative isotropic curvature was established in [19]:

Theorem 4.4 (S. Brendle [19]). *Let (M, g_0) be a compact, simply connected Riemannian manifold of dimension $n \geq 4$ which is irreducible and has nonnegative isotropic curvature. Then one of the following statements holds:*

- (i) M is homeomorphic to S^n .
- (ii) $n = 2m$ and (M, g_0) is a Kähler manifold.
- (iii) (M, g_0) is isometric to a symmetric space.

M. Berger [11] has shown that any quaternionic-Kähler manifold with positive sectional curvature is isometric to $\mathbb{H}\mathbb{P}^m$ up to scaling. More recently, H. Seshadri proved that any Kähler manifold which satisfies the assumptions of Theorem 4.4 is biholomorphic to a complex projective space or isometric to a Hermitian symmetric space (see [76], Theorem 1.2). We now state another consequence of Theorem 4.3.

Theorem 4.5. *Let (M, g_0) be a compact, locally irreducible Riemannian manifold of dimension $n \geq 4$ with the property that*

$$\begin{aligned} &R(e_1, e_3, e_1, e_3) + \lambda^2 R(e_1, e_4, e_1, e_4) \\ &+ R(e_2, e_3, e_2, e_3) + \lambda^2 R(e_2, e_4, e_2, e_4) \\ &- 2\lambda R(e_1, e_2, e_3, e_4) \geq 0 \end{aligned}$$

for all orthonormal four-frames $\{e_1, e_2, e_3, e_4\}$ and all $\lambda \in [0, 1]$. Moreover, let $g(t)$, $t \in [0, T)$, denote the unique maximal solution to the Ricci flow with initial metric g_0 . Then one of the following statements holds:

- (i) The rescaled metrics $\frac{1}{2(n-1)(T-t)} g(t)$ converge to a metric of constant sectional curvature 1 as $t \rightarrow T$.
- (ii) $n = 2m$ and the universal cover of (M, g_0) is a Kähler manifold.
- (iii) (M, g_0) is locally symmetric.

In particular, if (M, g_0) is weakly $1/4$ -pinched in the pointwise sense, then (M, g_0) satisfies the assumptions of Theorem 4.5. Hence, we have completed the proof of Theorem 1.7.

In the remainder of this section, we describe some results concerning almost $1/4$ -pinched manifolds. The first result in this direction was proved by M. Berger in 1983.

Theorem 4.6 (M. Berger [12]). *For every even integer n , there exists a real number $\delta(n) \in (0, 1/4)$ with the following property: if (M, g_0) is a compact, simply connected Riemannian manifold of dimension n which is strictly $\delta(n)$ -pinched in the global sense, then M is homeomorphic to S^n or diffeomorphic to a compact symmetric space of rank one.*

The proof of Theorem 4.6 is by contradiction, and relies on a compactness argument in the spirit of Gromov. In particular, the value of the pinching constant $\delta(n)$ is not known in general. U. Abresch and W. Meyer [1] showed that any compact, simply connected, odd-dimensional Riemannian manifold whose sectional curvatures lie in the interval $(\frac{1}{4(1+10^{-6})^2}, 1]$ is homeomorphic to a sphere. Using the classification in Theorem 4.5 and a Cheeger-Gromov-style compactness argument, P. Petersen and T. Tao obtained the following result:

Theorem 4.7 (P. Petersen, T. Tao [71]). *For each integer $n \geq 4$, there exists a real number $\delta(n) \in (0, 1/4)$ with the following property: if (M, g_0) is a compact, simply connected Riemannian manifold of dimension n which is strictly $\delta(n)$ -pinched in the global sense, then M is diffeomorphic to a sphere or a compact symmetric space of rank one.*

The conclusion of Theorem 4.7 can be improved slightly when n is odd. In this case, there exists a real number $\delta(n) \in (0, 1/4)$ with the property that every compact n -dimensional manifold (M, g_0) which is strictly $\delta(n)$ -pinched in the global sense is diffeomorphic to a spherical space form.

Finally we discuss some open problems in the study of positive curvature. First there are two well-known conjectures of H. Hopf.

Conjecture 4.8 (Hopf). *There is no metric of positive sectional curvature on $S^2 \times S^2$.*

Conjecture 4.9 (Hopf). *If n is even and M^n is a compact manifold with positive sectional curvature, then the Euler characteristic of M is positive.*

Concerning the first problem, we do not know of any compact simply connected manifold which admits a metric of nonnegative sectional curvature but can be shown not to admit a metric of positive sectional curvature. The famous theorem of J.L. Synge (see [28]) which classifies fundamental groups of even dimensional manifolds of positive sectional curvature implies that $\mathbb{R}P^2 \times \mathbb{R}P^2$ does not admit a metric with positive sectional curvature. There does not seem to be a viable method to approach the second Hopf conjecture at this time.

It would be interesting to understand the fundamental groups of manifolds with positive isotropic curvature (see [34] and [40]).

Conjecture 4.10. *The fundamental group of a compact manifold of positive isotropic curvature contains a free subgroup of finite index.*

One possible approach to this conjecture involves the Ricci flow. For initial metrics with positive isotropic curvature, the Ricci flow will, in general, develop singularities. For $n = 4$, the singularities were analyzed by Hamilton [50], but the case $n \geq 5$ is open.

We expect that there is an almost $1/4$ -pinching theorem assuming only pointwise pinching. Even the topological version of this is unknown. The proof will require a more sophisticated technique.

Conjecture 4.11. *Theorems 4.6 and 4.7 hold with the assumption of pointwise pinching replacing global pinching.*

References

- [1] U. Abresch and W. Meyer, *A sphere theorem with a pinching constant below $1/4$* , J. Diff. Geom. 44, 214–261 (1996)
- [2] S. Aloff and N. Wallach, *An infinite family of distinct 7-manifolds admitting positively curved Riemannian structures*, Bull. Amer. Math. Soc. 81, 93–97 (1975)
- [3] B. Andrews and H. Nguyen, *Four-manifolds with $1/4$ -pinched flag curvatures*, Asian J. Math. 13, 251–270 (2009)
- [4] J. Baez, *The octonions*, Bull. Amer. Math. Soc. (N.S.) 39, 145–205 (2002)
- [5] Y. Bazaikin, *On a family of 13-dimensional closed Riemannian manifolds of positive curvature*, Siberian Math. J. 37, 1068–1085 (1996)
- [6] L. Bérard-Bergery, *Les variétés riemanniennes homogènes simplement connexes de dimension impaire à courbure strictement positive*, J. Math. Pures Appl. 55, 47–67 (1976)
- [7] M. Berger, *Sur les groupes d'holonomie homogènes des variétés à connexion affine et des variétés riemanniennes*, Bull. Soc. Math. France 283, 279–330 (1955)
- [8] M. Berger, *Les variétés Riemanniennes $1/4$ -pincées*, Ann. Scuola Norm. Sup. Pisa 14, 161–170 (1960)
- [9] M. Berger, *Sur quelques variétés riemanniennes suffisamment pincées*, Bull. Soc. Math. France 88, 57–71 (1960)
- [10] M. Berger, *Les variétés riemanniennes homogènes normales simplement connexes à courbure strictement positive*, Ann. Scuola Norm. Sup. Pisa 15, 179–246 (1961)
- [11] M. Berger, *Trois remarques sur les variétés riemanniennes à courbure positive*, C.R. Acad. Sci. Paris Sér. A-B 263, A76–A78 (1966)
- [12] M. Berger, *Sur les variétés riemanniennes pincées juste au-dessous de $1/4$* , Ann. Inst. Fourier (Grenoble) 33, 135–150 (1983)

-
- [13] M. Berger, *A panoramic view of Riemannian geometry*, Springer-Verlag, Berlin (2003)
- [14] G. Besson, *Preuve de la conjecture de Poincaré en déformant la métrique par la courbure de Ricci (d'après G. Perelman)*, Séminaire Bourbaki 2004/2005, Astérisque 307, 309–347 (2006)
- [15] G. Besson, *Le théorème de la sphère différentiable (d'après S. Brendle et R. Schoen)*, Séminaire Bourbaki 2008/2009, Astérisque (to appear)
- [16] C. Böhm and B. Wilking, *Manifolds with positive curvature operator are space forms*, Ann. of Math. 167, 1079–1097 (2008)
- [17] J.M. Bony, *Principe du maximum, inégalité de Harnack et unicité du problème de Cauchy pour les opérateurs elliptiques dégénérés*, Ann. Inst. Fourier (Grenoble) 19, 277–304 (1969)
- [18] S. Brendle, *A general convergence result for the Ricci flow*, Duke Math. J. 145, 585–601 (2008)
- [19] S. Brendle, *Einstein manifolds with nonnegative isotropic curvature are locally symmetric*, Duke Math. J. 151, 1–21 (2010)
- [20] S. Brendle, *Ricci Flow and the Sphere Theorem*, Graduate Studies in Mathematics, vol. 111, American Mathematical Society (2010)
- [21] S. Brendle and R. Schoen, *Classification of manifolds with weakly $1/4$ -pinched curvatures*, Acta Math. 200, 1–13 (2008)
- [22] S. Brendle and R. Schoen, *Manifolds with $1/4$ -pinched curvature are space forms*, J. Amer. Math. Soc. 22, 287–307 (2009)
- [23] S. Brendle and R. Schoen, *Sphere theorems in geometry*, Surveys in Differential Geometry, vol. XIII, 49–84 International Press, Somerville MA (2009)
- [24] E. Brieskorn, *Examples of singular normal complex spaces which are topological manifolds*, Proc. Natl. Acad. Sci. USA 55, 1395–1397 (1966)
- [25] E. Brieskorn, *Beispiele zur Differentialtopologie von Singularitäten*, Invent. Math. 2, 1–14 (1966)
- [26] S.E. Cappell and J.L. Shaneson, *Some new four-manifolds*, Ann. of Math. 104, 61–72 (1976)
- [27] A. Chang, M. Gursky, and P. Yang, *A conformally invariant sphere theorem in four dimensions*, Publ. Math. IHÉS 98, 105–143 (2003)
- [28] J. Cheeger and D. Ebin, *Comparison theorems in Riemannian geometry*, AMS Chelsea Publishing, Providence RI (2008)
- [29] H. Chen, *Pointwise $1/4$ -pinched 4-manifolds*, Ann. Global Anal. Geom. 9, 161–176 (1991)
- [30] D. DeTurck, *Deforming metrics in the direction of their Ricci tensors*, J. Diff. Geom. 18, 157–162 (1983)
- [31] J.-H. Eschenburg, *New examples of manifolds with strictly positive curvature*, Invent. Math. 66, 469–480 (1982)
- [32] J.-H. Eschenburg and M. Kerin, *Almost positive curvature on the Gromoll-Meyer 7-sphere*, Proc. Amer. Math. Soc. 136, 3263–3270 (2008)

-
- [33] R. Fintushel and R.J. Stern, *An exotic free involution on S^4* , Ann. of Math. 113, 357–365 (1981)
- [34] A. Fraser, *Fundamental groups of manifolds with positive isotropic curvature*, Ann. of Math. 158, 345–354 (2003)
- [35] M.H. Freedman, *The topology of four-dimensional manifolds*, J. Diff. Geom. 17, 357–453 (1982)
- [36] S. Gadgil and H. Seshadri, *On the topology of manifolds with positive isotropic curvature*, Proc. Amer. Math. Soc. 137, 1807–1811 (2009)
- [37] D. Gromoll, *Differenzierbare Strukturen und Metriken positiver Krümmung auf Sphären*, Math. Ann. 164, 353–371 (1966)
- [38] D. Gromoll and W. Meyer, *An exotic sphere with nonnegative sectional curvature*, Ann. of Math. 100, 401–406 (1974)
- [39] M. Gromov, *Curvature, diameter and Betti numbers*, Comment. Math. Helv. 56, 179–195 (1981)
- [40] M. Gromov, *Positive curvature, macroscopic dimension, spectral gaps and higher signatures*, Functional analysis on the eve of the 21st century, Vol. II (New Brunswick 1993), 1–213, Progr. Math., 132, Birkhäuser, Boston (1996)
- [41] K. Grove, *Developments around positive sectional curvature*, Surveys Differential Geometry, vol. XIII, International Press, Somerville, MA (2009)
- [42] K. Grove, H. Karcher, and E. Ruh, *Group actions and curvature*, Invent. Math. 23, 31–48 (1974)
- [43] K. Grove, H. Karcher, and E. Ruh, *Jacobi fields and Finsler metrics on compact Lie groups with an application to differentiable pinching problems*, Math. Ann. 211, 7–21 (1974)
- [44] K. Grove and K. Shiohama, *A generalized sphere theorem*, Ann. of Math. 106, 201–211 (1977)
- [45] H.L. Gu, *A new proof of Mok’s generalized Frankel conjecture theorem*, Proc. Amer. Math. Soc. 137, 1063–1068 (2009)
- [46] R. Hamilton, *Three-manifolds with positive Ricci curvature*, J. Diff. Geom. 17, 255–306 (1982)
- [47] R. Hamilton, *Four-manifolds with positive curvature operator*, J. Diff. Geom. 24, 153–179 (1986)
- [48] R. Hamilton, *The Harnack estimate for the Ricci flow*, J. Diff. Geom. 37, 225–243 (1993)
- [49] R. Hamilton, *The formation of singularities in the Ricci flow*, Surveys in Differential Geometry, vol. II, 7–136, International Press, Somerville MA (1995)
- [50] R. Hamilton, *Four-manifolds with positive isotropic curvature*, Comm. Anal. Geom. 5, 1–92 (1997)
- [51] F. Hirzebruch, *Singularities and exotic spheres*, Séminaire Bourbaki vol. 10, Exp. No. 314, 13–32 Soc. Math. France, Paris (1995)
- [52] N. Hitchin, *Harmonic spinors*, Adv. Math. 14, 1–55 (1974)
- [53] H. Hopf, *Zum Clifford-Kleinschen Raumproblem*, Math. Ann. 95, 313–339 (1926)

-
- [54] H. Hopf, *Differentialgeometrie und topologische Gestalt*, Jahresber. Deutsch. Math.-Verein. 41, 209–229 (1932)
- [55] G. Huisken, *Ricci deformation of the metric on a Riemannian manifold*, J. Diff. Geom. 21, 47–62 (1985)
- [56] H. Im Hof and E. Ruh, *An equivariant pinching theorem*, Comment. Math. Helv. 50, 389–401 (1975)
- [57] M. Joachim and D. Wraith, *Exotic spheres and curvature*, Bull. Amer. Math. Soc. (N.S.) 45, 595–616 (2008)
- [58] M. Kervaire and J. Milnor, *Groups of homotopy spheres, I*, Ann. of Math. 77, 504–537 (1963)
- [59] W. Klingenberg, *Über Riemannsche Mannigfaltigkeiten mit positiver Krümmung*, Comment. Math. Helv. 35, 47–54 (1961)
- [60] B. Leeb, *Geometrization of 3-dimensional manifolds and Ricci flow: on Perelman’s proof of the conjectures of Poincaré and Thurston*, Boll. Unione Mat. Ital. (9) 1, 41–55 (2008)
- [61] C. Margerin, *Pointwise pinched manifolds are space forms*, Geometric measure theory and the calculus of variations (Arcata 1984), 343–352, Proc. Sympos. Pure Math. 44, Amer. Math. Soc., Providence RI (1986)
- [62] C. Margerin, *A sharp characterization of the smooth 4-sphere in curvature terms*, Comm. Anal. Geom. 6, 21–65 (1998)
- [63] D. Máximo, *Non-negative Ricci curvature on closed manifolds under Ricci flow*, preprint (2009)
- [64] M. Micalef and J.D. Moore, *Minimal two-spheres and the topology of manifolds with positive curvature on totally isotropic two-planes*, Ann. of Math. 127, 199–227 (1988)
- [65] J. Milnor, *On manifolds homeomorphic to the 7-sphere*, Ann. of Math. 64, 399–405 (1956)
- [66] H. Nguyen, *Isotropic curvature and the Ricci flow*, Internat. Math. Res. Notices no. 3, 536–558 (2010)
- [67] S. Nishikawa, *Deformation of Riemannian metrics and manifolds with bounded curvature ratios*, Geometric measure theory and the calculus of variations (Arcata 1984), 343–352, Proc. Sympos. Pure Math. 44, Amer. Math. Soc., Providence RI (1986)
- [68] G. Perelman, *The entropy formula for the Ricci flow and its geometric applications*, arxiv:0211159
- [69] G. Perelman, *Ricci flow with surgery on three-manifolds*, arxiv:0303109
- [70] G. Perelman, *Finite extinction time for solutions to the Ricci flow on certain three-manifolds*, arxiv:0307245
- [71] P. Petersen and T. Tao, *Classification of almost quarter-pinched manifolds*, Proc. Amer. Math. Soc. 137, 2437–2440 (2009)
- [72] H.E. Rauch, *A contribution to differential geometry in the large*, Ann. of Math. 54, 38–55 (1951)

-
- [73] E. Ruh, *Krümmung und differenzierbare Struktur auf Sphären, II*, Math. Ann. 205, 113–129 (1973)
- [74] E. Ruh, *Riemannian manifolds with bounded curvature ratios*, J. Diff. Geom. 17, 643–653 (1982)
- [75] R. Schoen and S.T. Yau, *Lectures on Harmonic Maps*, International Press, Cambridge (1997)
- [76] H. Seshadri, *Manifolds with nonnegative isotropic curvature*, Comm. Anal. Geom. 17, 621–635 (2009)
- [77] N. Šešum, *Curvature tensor under the Ricci flow*, Amer. J. Math. 127, 1315–1324 (2005)
- [78] S. Smale, *Generalized Poincaré’s conjecture in dimensions greater than four*, Ann. of Math. 74, 391–406 (1961)
- [79] S. Stolz, *Simply connected manifolds of positive scalar curvature*, Ann. of Math. 136, 511–540 (1992)
- [80] M. Sugimoto and K. Shiohama, and H. Karcher, *On the differentiable pinching problem*, Math. Ann. 195, 1–16 (1971)
- [81] N. Wallach, *Compact homogeneous Riemannian manifolds with strictly positive curvature*, Ann. of Math. 96, 277–295 (1972)
- [82] F. Wilhelm, *An exotic sphere with positive curvature almost everywhere*, J. Geom. Anal. 11, 519–560 (2001)
- [83] J. Wolf, *Spaces of constant curvature*, Publish or Perish, Houston TX (1984)

On the Cohomology of Algebraic Varieties

Claire Voisin*

Abstract

An algebraic variety is an object which can be defined in a purely algebraic way, starting from polynomials or more generally from finitely generated algebras over fields. When the base field is the field of complex numbers, it can also be seen as a complex manifold, and more precisely a Kähler manifold. We will review a number of notions and results related to these two aspects of complex algebraic geometry. A crucial notion is that of Hodge structure, which already appears in the Kähler context, but seems to be meaningful and interpretable only in the context of algebraic geometry.

Mathematics Subject Classification (2010). 14F25, 14F40, 14C30, 32Q15

Keywords. Cohomology, Kähler manifolds, Hodge structures, de Rham cohomology, Hodge conjecture

1. Introduction

1.1. From topology to geometry and vice-versa. An algebraic variety V is defined by polynomial equations which are polynomials with coefficients in some field K . For any field K' containing K , one considers the set $V(K')$ of solutions with coefficients in K' . In particular, if $K \subset \mathbb{C}$, one can consider $V(\mathbb{C})$ which will be a subvariety of an affine or projective space. When the equations defining $V(\mathbb{C})$ locally satisfy the Jacobian criterion, $V(\mathbb{C})$ can also be seen as a complex manifold, and in particular a topological space, which is compact if the original V is projective. In fact, it is endowed with a so-called Kähler metric, which happens to be extremely restrictive topologically. So we get a first set of forgetting maps:

$$\begin{aligned} \{\text{Algebraic varieties over } K \subset \mathbb{C}\} &\rightsquigarrow \{\text{Algebraic varieties over } \mathbb{C}\} \\ &\rightsquigarrow \{\text{Compact Kähler manifolds}\}. \end{aligned}$$

*CNRS and Institut de Mathématiques de Jussieu. E-mail: voisin@math.jussieu.fr

Each step above can be seen as an enlargement of the category of functions used on the space $V(\mathbb{C})$: in the first case, rational functions with K -coefficients, in the second case, rational functions with complex coefficients, and in the third case, holomorphic functions rather than polynomials or rational functions.

That some structure is lost at each step is obvious, but it is not so clear whether these changes of category of pairs consisting of a space plus a class of functions, also correspond to relaxing topological restrictions. However, it was shown by Serre [39] in the 60's, for the first inclusion, and by the author [49] in 2004 for the second one, that at each step we get a strict inclusion at the level of topological spaces, even modulo homotopy equivalence. This will be the subject of section 3.3.

Starting with a compact Kähler manifold, we can forget some of its geometric structure. Indeed, a Kähler manifold is at the same time a complex manifold, a symplectic manifold and a Riemannian manifold, the three structures being compatible in a very nice way. It has been known for a very long time that compact Kähler manifolds are more restricted topologically than complex or symplectic manifolds. We will show in section 3.2 that there are in fact many more topological restrictions than the classical ones, obtained by introducing and exploiting the notion of *Hodge structure on a cohomology algebra* introduced in [54].

Continuing further, we can also forget about the complex structure or the symplectic structure, and then keep the differentiable manifold. All these operations again enlarge the class of topological spaces considered. Finally we can even forget about the differentiable structure and consider only the underlying topological space, which is a topological manifold. Its homotopy type or cohomology can be computed by combinatorial data: it is determined by the combinatorics of a good covering by open balls. A major result due to Donaldson [23] says that some topological manifolds do not admit any differentiable structure, so that in this last step, we still enlarge the category of topological spaces involved. Doing so, we also lose a tool which makes the essential bridge between geometry and topology, namely the use of differential forms to compute cohomology (and even homotopy, according to Sullivan [42]), which can be summarized under the name of de Rham theory and will be a guiding theme of this paper.

While we made a long walk from algebraic varieties to topological spaces, de Rham theorems appear to be crucial to understand partially the cohomology of a smooth complex algebraic variety V defined over a field $K \subset \mathbb{C}$, using only its structure as an algebraic variety (eg the ideal of polynomials vanishing on it), and not the topology of $V(\mathbb{C})$. The key point here is the fact that differentiating polynomial or rational functions is a formal operation. This way we can speak of algebraic differential forms and use them to “compute” the cohomology of our algebraic variety (cf. [29]).

A very mysterious and crucial fact is the following: according to whether we consider our complex algebraic variety over $K \subset \mathbb{C}$ as a topological space with

its complex of singular cochains, or as a differentiable manifold with its complex of differential forms, or as a K -variety with its complex of algebraic differential forms with K -coefficients, we compute the “same” cohomology groups, but with *different coefficients* (\mathbb{Q} -coefficients for Betti cohomology, \mathbb{R} or \mathbb{C} -coefficients for differentiable de Rham cohomology, K -coefficients for algebraic de Rham cohomology). Comparing these various groups is crucial in the theory of motives, or of periods (cf. [1]).

We will put the emphasis in this text on the following fact: Hodge theory on a compact Kähler manifold X provides beautiful objects attached to X , namely a Hodge structure of weight k on its rational cohomology of degree k , for any $k \geq 0$. We will show how to extract from the existence of such Hodge structures topological restrictions on X . When X is projective, it is furthermore expected that these Hodge structures reflect faithfully certain algebro-geometric properties of X , related to the structure of its algebraic subvarieties. The simplest example of such expectation is the Hodge conjecture, which predicts from the shape of the Hodge structure on $H^{2k}(X, \mathbb{Q})$ which degree $2k$ rational cohomology classes are generated over \mathbb{Q} by classes of algebraic subvarieties of codimension k of X . This conjecture cannot be extended in the Kähler context (cf. [47] and section 2.1), which suggests that this is not a conjecture in complex differential topology, and that some extra structure existing on the cohomology of algebraic varieties, compatible with Hodge theory, has to be exploited. We will try to give an idea of what can be done in this direction in section 4. The rest of this introduction makes more precise the various tools and notions alluded to above.

1.2. De Rham theorems and Hodge theory. The degree i Betti cohomology $H^i(X, A)$ of a reasonable topological space (say a topological manifold) with value in any abelian group A can be computed in several ways, which correspond to various choices of acyclic resolutions of the constant sheaf A on X . Concretely, one can choose a triangulation of X and consider the simplicial cohomology of the associated simplicial complex. A more general approach uses singular cohomology, built from continuous cochains and their boundaries. The last one involves a good covering by open balls and the associated Čech complex.

The last approach, which is also the most natural from the viewpoint of sheaf cohomology, led Weil [56] to a new proof of the fundamental de Rham theorem [22], which says that in the differentiable case, cohomology with real coefficients can be computed using the complex of differential forms:

Theorem 1.1. (*de Rham*) *If X is a differentiable manifold, one has*

$$H^i(X, \mathbb{R}) = \frac{\{\text{closed real } i\text{-forms on } X\}}{\{\text{exact real } i\text{-forms on } X\}}. \quad (1.1)$$

An important point however is the fact that de Rham cohomology does not detect cohomology with rational coefficients.

The next step in relating topology and geometry is the major advance in differential topology due to Hodge (cf. [27], [48, Chapter 5]), which provides canonical representatives for the cohomology of a compact differentiable manifold endowed with a Riemannian metric.

For a general oriented Riemannian manifold (X, g) , with corresponding volume form Vol_g , one has the Laplacian Δ_d acting on differential forms, preserving the degree, and given by the formula $\Delta_d = dd^* + d^*d$, where d^* is the formal adjoint of d with respect to the L^2 -metric $(\alpha, \beta)_{L^2} := \int_X \langle \alpha, \beta \rangle Vol_g$ on compactly supported forms. A differential form α is said to be harmonic if $\Delta_d \alpha = 0$, or equivalently in the compact case, $d\alpha = d^*\alpha = 0$. When X is compact, a harmonic form on X has thus a de Rham cohomology class.

Theorem 1.2. (*Hodge*) *Let X be a compact orientable differentiable manifold. Then the map $\mathcal{H}^i(X) \rightarrow H^i(X, \mathbb{R})$ from the space of harmonic i -forms on X to real cohomology of degree i , which to a harmonic form associates its de Rham class, is an isomorphism.*

1.3. Kähler geometry and algebraic geometry. A complex manifold (of complex dimension n) is a differentiable manifold of real dimension $2n$ with a set of charts with values in open sets of \mathbb{C}^n such that the transition diffeomorphisms are holomorphic. Its tangent space has then a natural structure of complex vector bundle, given by its local identifications to the tangent space of \mathbb{C}^n .

A Kähler metric is a Hermitian metric on the tangent bundle of a complex manifold X which fits very nicely with the complex structure on X : The Hermitian metric h being locally written in holomorphic coordinates as $\sum_{i,j} h_{ij} dz_i \otimes d\bar{z}_j$, there is the corresponding real $(1, 1)$ -form

$$\omega = \frac{i}{2} \sum_{i,j} h_{ij} dz_i \wedge d\bar{z}_j,$$

(the Kähler form), and the Kähler condition is simply $d\omega = 0$. The closed 2-form ω has a de Rham class $[\omega] \in H^2(X, \mathbb{R})$, called the Kähler class of the metric.

A projective complex variety X (defined over a field $K \subset \mathbb{C}$) is the set of solutions of a finite number of equations $P_i(x) = 0$, $x = (x_0, \dots, x_N) \in \mathbb{P}^N(\mathbb{C})$, where the P_i are homogeneous polynomials (with coefficients in K) in the coordinates x_i .

The P_i 's give local rational, hence holomorphic, equations for X , which is thus a closed analytic subset of $\mathbb{P}^N(\mathbb{C})$ as well. A remarkable result due to Chow and generalized later on by Serre [38] says that any closed analytic subset of $\mathbb{P}^N(\mathbb{C})$ is in fact algebraic. When the local defining equations of X can be chosen to have independent differentials, X is a complex submanifold of $\mathbb{P}^N(\mathbb{C})$. We will say that X is a complex projective manifold (defined over K).

The Kodaira criterion [32] characterizes projective complex manifolds inside the class of compact Kähler manifolds.

Theorem 1.3. *A compact complex manifold X is projective if and only if X admits a Kähler class $[\omega]$ which is rational, that is belongs to*

$$H^2(X, \mathbb{Q}) \subset H^2(X, \mathbb{R}).$$

The “only if” is easy. It comes from the fact that if X is projective, one gets a Kähler form on X by restricting the Fubini-Study Kähler form on some projective space \mathbb{P}^N in which X is imbedded as a complex submanifold. But the Fubini-Study Kähler form has integral cohomology class, as its class is the first Chern class of the holomorphic line bundle $\mathcal{O}_{\mathbb{P}^N}(1)$ on \mathbb{P}^N .

The converse is a beautiful application of the Kodaira vanishing theorem for line bundles endowed with a metric whose Chern form is positive.

1.4. Topology and algebraic geometry. As we mentioned already, one way to put a topology on a complex algebraic variety is to use the topology on the ambient space \mathbb{C}^n or $\mathbb{C}\mathbb{P}^n$. This is what we will call the classical topology. There is however another topology, the Zariski topology, which has the property that the closed subsets are the closed algebraic subsets of X , that is, subsets defined by the vanishing of polynomial equations restricted to X . These sets are closed for the classical topology, so this topology is weaker than the classical topology.

This topology is in fact very weak. Indeed, if the variety is “irreducible” (for example smooth and connected), any two Zariski open sets intersect non trivially by analytic continuation. It easily follows that the cohomology of X , endowed with the Zariski topology, with constant coefficients, (that is, with value in a constant sheaf) is trivial. However, the Zariski topology is excellent to compute the cohomology of X with values in other softer sheaves, namely the “coherent sheaves”: There is the notion of algebraic vector bundle on X , and even algebraic vector bundle defined over K if X is. Namely, in some Zariski open cover (defined over K), it is trivialized, and the transition matrices are matrices of algebraic functions with K -coefficients. The simplest coherent sheaves are sheaves of algebraic sections of such vector bundles. The general ones allow singularities.

Let us assume that $K = \mathbb{C}$ and let E be such an algebraic vector bundle. There are two things we can do to compute the “cohomology of X with value in E ”.

- 1) X is endowed with the Zariski topology and one considers the sheaf \mathcal{E} of algebraic sections of E . Then we compute cohomology of the sheaf \mathcal{E} by general methods of sheaf cohomology, using acyclic resolutions. Concretely, it suffices to compute Čech cohomology with respect to an affine covering. Let us denote these groups $H^l(X_{Zar}, \mathcal{E})$.
- 2) We put on X the classical topology and consider the sheaf of *holomorphic* sections \mathcal{E}^{an} of E in the classical topology. Let us denote these groups $H^l(X_{cl}, \mathcal{E}^{an})$.

It is a remarkable fact (the “GAGA principle”, [38]), proved by Serre, that the resulting cohomology groups are the same.

Theorem 1.4. (Serre) *For any algebraic coherent sheaf \mathcal{E} on X , one has a canonical (inverse image) isomorphism $H^l(X_{Zar}, \mathcal{E}) \rightarrow H^l(X_{cl}, \mathcal{E}^{an})$.*

Why then to care about the Zariski topology and the algebraic vector bundles? One reason is the fact that staying in the algebraic geometry setting allows to take care of the fields of definition of a variety X and a vector bundle E on it; such a field of definition contains the coefficients of defining equations of X , or the coefficients of rational functions involved in the transition matrices of E . If X, E are defined over a subfield $K \subset \mathbb{C}$, then we can compute the cohomology of X_K , endowed with the “ K -Zariski topology” (for which closed subsets are closed algebraic subsets defined by polynomial equations with K -coefficients), with value in \mathcal{E}_K (the sheaf of sections defined over K), and there is an isomorphism (which is called a K -structure on $H^i(X, \mathcal{E})$):

$$H^i(X, \mathcal{E}) = H^i(X_K, \mathcal{E}_K) \otimes_K \mathbb{C}.$$

We already mentioned that the Zariski topology is not good at all to compute Betti cohomology of X endowed with its classical topology. However, holomorphic de Rham theory combined with GAGA allows in fact to compute Betti cohomology of X , at least with complex coefficients, using algebraic differentials and the Zariski topology. This result due to Grothendieck [29] is crucial to understand the notion of absolute Hodge class [19] that will be discussed in section 4.2.

Étale cohomology invented by Grothendieck is another way of constructing an intrinsic cohomology theory, not depending on the topology of the field \mathbb{C} . It depends on introducing étale topology which is a refinement of Zariski topology, and is not actually a topology: Roughly speaking, one adds to the Zariski open sets their étale covers. Furthermore, Artin’s comparison theorems allow to compare it to Betti cohomology. However, this theory does not allow to recover Betti cohomology with *rational* coefficients (see for example [13]) of our classical topological space X , but only its Betti cohomology with finite or l -adic coefficients.

The presence of various cohomology theories with comparison theorems between them is at the heart of Grothendieck’s theory of *Motives* (cf. [1]).

Our last topic in section 4.4 will be another way to go around the fact that the Zariski topology is too weak to compute Betti cohomology of the corresponding complex manifold. This is by looking at the spectral sequence associated to the obviously continuous map

$$X_{cl} \rightarrow X_{Zar}$$

which is the identity on points. This study is done by Bloch-Ogus [8] and leads to beautiful results when combined with algebraic K -theory.

2. Hodge Theory in Kähler or Projective Geometry

2.1. Hodge structures. Let us start with the notion of cohomology class of type (p, q) on a complex manifold X . On such an X , we have the notion of differential form of type (p, q) : these are the complex differential forms α (say of class \mathcal{C}^∞), which can be written in local holomorphic coordinates z_1, \dots, z_n , $n = \dim_{\mathbb{C}} X$, and in the multiindex notation:

$$\alpha = \sum_{I, J} \alpha_{I, J} dz_I \wedge d\bar{z}_J, \quad |I| = p, \quad |J| = q,$$

where $\alpha_{I, J}$ are \mathcal{C}^∞ functions. Let us denote $A^{p, q}(X)$ the space of (p, q) -forms on X . Thus $A^{p, q}(X) \subset A^k(X)$, $p + q = k$, where $A^k(X)$ is the space of \mathcal{C}^∞ complex differential k -forms on X . The cohomology $H^k(X, \mathbb{C})$ with complex coefficients can be computed by de Rham theorem as

$$H^k(X, \mathbb{C}) = \frac{\{\text{closed complex } k\text{-forms on } X\}}{\{\text{exact complex } k\text{-forms on } X\}},$$

and it is natural to define for a complex manifold X and for each (p, q) the space of cohomology classes of type (p, q) by the formula

$$H^{p, q}(X) := \frac{\{\text{closed forms of type } (p, q) \text{ on } X\}}{\{\text{exact forms of type } (p, q) \text{ on } X\}}.$$

The following result is a famous result due to Hodge.

Theorem 2.1. (*The Hodge decomposition theorem*) *Let X be a compact Kähler manifold. Then for any integer k , one has $H^k(X, \mathbb{C}) = \bigoplus_{p+q=k} H^{p, q}(X)$.*

The proof of this theorem uses the representation of cohomology classes by harmonic forms (Theorem 1.2 above), together with the fact that the (p, q) -components of harmonic forms are harmonic, a fact which is specific to the Kähler case.

The decomposition above satisfies *Hodge symmetry*, which says that

$$\overline{H^{p, q}(X)} = H^{q, p}(X), \quad (2.2)$$

where complex conjugation acts naturally on $H^k(X, \mathbb{C}) = H^k(X, \mathbb{R}) \otimes_{\mathbb{R}} \mathbb{C}$. This is because the complex conjugate of a closed form of type (p, q) is a closed form of type (q, p) .

We have the change of coefficients theorems $H^k(X, \mathbb{Q}) \otimes_{\mathbb{Q}} \mathbb{C} \cong H^k(X, \mathbb{C})$. On the other hand, Theorem 2.1 gives the decomposition $H^k(X, \mathbb{C}) = \bigoplus_{p+q=k} H^{p, q}(X)$, satisfying Hodge symmetry (2.2). These data are summarized in the following definition.

Definition 2.2. A rational (resp. integral) Hodge structure of weight k is a finite dimensional \mathbb{Q} -vector space (resp. a lattice, that is a free \mathbb{Z} -module of finite rank) V , together with a decomposition:

$$V_{\mathbb{C}} := V \otimes_{\mathbb{Q}} \mathbb{C} = \bigoplus_{p+q=k} V^{p,q}$$

satisfying Hodge symmetry.

The cohomology $H^k(X, \mathbb{Q})$, X compact Kähler, carries such a structure. Note that the Hodge decomposition depends on the Kähler complex structure. Furthermore, the dimensions $h^{p,q}(X) := \text{rk } H^{p,q}(X)$ are not topological invariants of X , although they are constant under deformations of the Kähler complex structure. However, the following classical remark shows that the Hodge decomposition provides topological restrictions on compact Kähler manifolds.

Remark 2.3. A Hodge structure of odd weight has its underlying \mathbb{Q} -vector space of even dimension. Hence a compact Kähler manifold X has

$$b_{2i+1}(X) := \dim_{\mathbb{Q}} H^{2i+1}(X, \mathbb{Q})$$

even for any i .

Example 2.4. There is an equivalence of categories between the set of (integral) Hodge structures of weight 1 and the set of complex tori. To $L, L_{\mathbb{C}} = L^{1,0} \oplus \bar{L}^{1,0}$ corresponds $T := \frac{L_{\mathbb{C}}}{L^{1,0} \oplus \bar{L}^{1,0}}$. In the reverse direction, associate to T the Hodge structure on $H^{2g-1}(T, \mathbb{Z})$, $g = \dim T$.

Example 2.5. (Trivial Hodge structure) A Hodge structure $(V, V^{p,q})$ of weight $2k$ is trivial if $V_{\mathbb{C}} = V^{k,k}$.

The following definition is crucial:

Definition 2.6. If $(V, V^{p,q})$ is a rational Hodge structure of weight $2k$, Hodge classes of V are elements of $V \cap V^{k,k}$.

The simplest examples of Hodge classes on a compact Kähler manifold are given by the cohomology classes of closed analytic subspaces $Z \subset X$ of codimension k . The singular locus Z_{sing} of such a Z is then a closed analytic subset of X which has codimension $\geq k + 1$ and thus real codimension $\geq 2k + 2$. Thus one can define

$$[Z] \in H^{2k}(X, \mathbb{Z})$$

by taking the cohomology class $[Z \setminus Z_{\text{sing}}] \in H^{2k}(X \setminus Z_{\text{sing}}, \mathbb{Z})$ of the closed complex submanifold

$$Z \setminus Z_{\text{sing}} \subset X \setminus Z_{\text{sing}}$$

and by observing that $H^{2k}(X \setminus Z_{\text{sing}}, \mathbb{Z}) \cong H^{2k}(X, \mathbb{Z})$.

The class $[Z]$ is an integral Hodge class. This can be seen using Lelong's theorem, showing that the current of integration over $Z \setminus Z_{\text{sing}}$ is well defined

and closed, with cohomology class equal to the image of $[Z]$ in $H^{2k}(X, \mathbb{C})$. On the other hand, this current annihilates all forms of type (p, q) , $p \neq q$, $p + q = 2n - 2k$, $n = \dim X$, and it follows dually that its class is of type (k, k) .

The Hodge conjecture is the following statement:

Conjecture 2.7. *Let X be a complex projective manifold. Then the space $Hdg^{2k}(X)$ of degree $2k$ rational Hodge classes on X is generated over \mathbb{Q} by classes $[Z]$ constructed above.*

It would be natural to try to formulate the Hodge conjecture in the Kähler context. However, it seems that there is no way to do this, and this is the reason why we will focus on the interplay between Hodge theory and algebraic geometry in section 4. First of all, it has been known for a long time that Hodge classes on compact Kähler manifolds are not in general generated over \mathbb{Q} by classes of closed analytic subsets. The simplest such example is provided by a complex torus T admitting a holomorphic line bundle \mathcal{L} of indefinite curvature. This means in this case that the harmonic de Rham representative of the Chern class $c_1(\mathcal{L})$ is given by a real $(1, 1)$ -form with constant coefficients on T having the property that the corresponding Hermitian form on the tangent space of T is indefinite. If the torus T satisfying this condition is chosen general enough, its space $Hdg^2(T)$ will be generated by $c_1(\mathcal{L})$, as one shows by a deformation argument. It follows that T will not contain any analytic hypersurface, hence no non zero degree 2 Hodge class can be constructed as the Hodge class of a codimension 1 closed analytic subset, while $c_1(\mathcal{L})$ provides a non zero Hodge class on T .

However, there are two other constructions of Hodge classes starting from analytic objects:

- 1) Chern classes of holomorphic vector bundles: one uses the Chern connection and Chern-Weil theory to show that they are indeed Hodge classes.
- 2) Chern classes of analytic coherent sheaves (that is, roughly speaking, sheaves of sections of singular holomorphic vector bundles): the construction is much more delicate. We refer to [28] for a recent elegant construction.

In the projective case, it is known that the three constructions generate over \mathbb{Q} the same space of Hodge classes (cf. [38] and [9]). In the general Kähler case, the torus example above shows that Chern classes of holomorphic vector bundles or coherent sheaves may provide more Hodge classes than cycle classes. The fact that Chern classes of coherent sheaves allow in some cases to construct strictly more Hodge classes than Chern classes of holomorphic vector bundles was proved in [47]. This is something which cannot be detected in degree 2, as in degree 2, Chern classes of holomorphic line bundles generate all integral Hodge classes, a fact which is known as the Lefschetz theorem on $(1, 1)$ -classes. To conclude, one can prove as in [9] that cycle classes are generated by Chern classes of analytic coherent sheaves.

If we want to extend the Hodge conjecture to the Kähler case, we therefore are led to consider the following question:

Question 2.8. *Are Hodge classes on compact Kähler manifolds generated over \mathbb{Q} by Chern classes of coherent sheaves?*

We provided in [47] a negative answer to this question. Weil tori [57] are complex tori T of even dimension $2n$ admitting an endomorphism ϕ satisfying $\phi^2 = -d\text{Id}_T$, $d > 0$ and a certain sign assumption concerning the action of ϕ on holomorphic forms on T , which implies that T carries a 2-dimensional \mathbb{Q} -vector space of Hodge classes of degree $2n$. The following result shows that they provide a counterexample to question 2.8, thus showing that the projectivity assumption is crucial in the statement of the Hodge conjecture.

Theorem 2.9. [47] *Let T be a general Weil torus of dimension 4. Then any analytic coherent sheaf \mathcal{F} on T satisfies $c_2(\mathcal{F}) = 0$. Thus the Weil Hodge classes on them are not in the space generated by Chern classes of coherent sheaves.*

2.2. Hard Lefschetz theorem and Hodge-Riemann relations. Another very deep application of Hodge theory is the hard Lefschetz theorem, which says the following: let X be a compact Kähler manifold of dimension n and $[\omega] \in H^2(X, \mathbb{R})$ be the class of a Kähler form ω on X . Cup-product with $[\omega]$ gives an operator usually denoted by $L : H^*(X, \mathbb{R}) \rightarrow H^{*+2}(X, \mathbb{R})$.

Theorem 2.10. *For any $k \leq n$,*

$$L^{n-k} : H^k(X, \mathbb{R}) \rightarrow H^{2n-k}(X, \mathbb{R})$$

is an isomorphism.

A first formal consequence of the hard Lefschetz theorem 2.10 is the so-called Lefschetz decomposition. With the same notations as before, define for $k \leq n$ the primitive degree k cohomology of X by

$$H^k(X, \mathbb{R})_{\text{prim}} := \text{Ker}(L^{n-k+1} : H^k(X, \mathbb{R}) \rightarrow H^{2n+2-k}(X, \mathbb{R})).$$

For example, if $k = 1$, the whole cohomology is primitive, and if $k = 2$, primitive cohomology is the same as the orthogonal subspace, with respect to Poincaré duality, of $[\omega]^{n-1} \in H^{2n-2}(X, \mathbb{R})$.

The Lefschetz decomposition is given in the following theorem (it can also be extended to $k > n$ using the hard Lefschetz isomorphism).

Theorem 2.11. *The cohomology groups $H^k(X, \mathbb{R})$ for $k \leq n$ decompose as*

$$H^k(X, \mathbb{R}) = \bigoplus_{2r \leq k} L^r H^{k-2r}(X, \mathbb{R})_{\text{prim}}.$$

2.2.1. Hodge-Riemann bilinear relations. We consider a Kähler compact manifold X with Kähler class $[\omega]$. We can define an intersection form q_ω on each $H^k(X, \mathbb{R})$ by the formula

$$q_\omega(\alpha, \beta) = \int_X [\omega]^{n-k} \cup \alpha \cup \beta.$$

By hard Lefschetz theorem and Poincaré duality, q_ω is a non-degenerate bilinear form. It is skew-symmetric if k is odd and symmetric if k is even. Furthermore, the extension of q_ω to $H^k(X, \mathbb{C})$ satisfies the property that

$$q_\omega(\alpha, \beta) = 0, \alpha \in H^{p,q}, \beta \in H^{p',q'}, (p', q') \neq (q, p).$$

This property is indeed an immediate consequence of Lemma 3.1 and the fact that $H^{2n}(X, \mathbb{C}) = H^{n,n}(X)$, $n = \dim_{\mathbb{C}} X$.

Equivalently, the Hermitian pairing h_ω on $H^k(X, \mathbb{C})$ defined by

$$h_\omega(\alpha, \beta) = \iota^k q_\omega(\alpha, \bar{\beta})$$

has the property that the Hodge decomposition is orthogonal with respect to h_ω . This property is summarized under the name of first Hodge-Riemann bilinear relations.

It is also an easy fact that the Lefschetz decomposition is orthogonal with respect to q_ω . To state the second Hodge-Riemann bilinear relations, note that, because the operator L shifts the Hodge decomposition by $(1, 1)$, the primitive cohomology has an induced Hodge decomposition:

$$H^k(X, \mathbb{C})_{prim} = \bigoplus_{p+q=k} H^{p,q}(X)_{prim},$$

with $H^{p,q}(X)_{prim} := H^{p,q}(X) \cap H^{p+q}(X, \mathbb{C})_{prim}$. We have now

Theorem 2.12. *The Hermitian form h_ω is definite of sign $(-1)^{\frac{k(k-1)}{2}} \iota^{p-q-k} =: \epsilon(p, q, r)$ on the component $L^r H^{p,q}(X)_{prim}$, $2r + p + q = k$, of $H^k(X, \mathbb{C})$.*

The Hodge-Lefschetz decomposition is particularly interesting when $[\omega]$ can be chosen to be rational, so that X is projective by Kodaira’s embedding Theorem 1.3. Indeed, in this case, this is a decomposition into a direct sum of rational Hodge substructures. Furthermore the intersection form q_ω is rational. On each piece of the Lefschetz decomposition, it induces up to sign a *polarization* of the considered Hodge substructure. This notion will come back later on. Let us just say that we mentioned in Example 2.4 the equivalence of categories

$$\{\text{Weight 1 Hodge structures}\} \leftrightarrow \{\text{Complex tori}\}.$$

This can be completed by saying that there is an equivalence of categories

$$\{\text{Weight 1 polarized Hodge Structures}\} \leftrightarrow \{\text{Abelian varieties}\}.$$

Indeed, an intersection form q on $L, L_{\mathbb{C}} = L^{1,0} \oplus \overline{L^{1,0}}$ satisfying the Hodge-Riemann bilinear relations as in Theorem 2.12 provides an integral Kähler class on the torus $T = L_{\mathbb{C}} / (L^{1,0} \oplus L)$ which is thus projective by Theorem 1.3.

3. Hodge Structures on Cohomology Algebras

The following simple Lemma 3.1 is a direct consequence of the following two facts:

- 1) Under the de Rham isomorphism (1.1), the cup-product is induced by wedge product of differential forms.
- 2) The wedge product of a closed (p, q) -form and of a closed (p', q') -form is a closed $(p + p', q + q')$ -form.

Lemma 3.1. *If X is a compact Kähler manifold, the Hodge decomposition on $H^*(X, \mathbb{C})$ is compatible with cup-product:*

$$H^{p,q}(X) \cup H^{p',q'}(X) \subset H^{p+p',q+q'}(X).$$

Below, a cohomology algebra A^* is the rational cohomology algebra of a connected orientable compact manifold, or more generally any graded commutative finite dimensional \mathbb{Q} -algebra satisfying Poincaré duality: for some integer $d \geq 0$, $A^0 = A^d = \mathbb{Q}$ and $A^k \otimes A^{d-k} \rightarrow A^d$ is perfect for any k . By analogy, d will be called the dimension of A^* .

Definition 3.2. (Voisin 2008) *A Hodge structure on A^* is the data of a Hodge structure of weight k on each A^k (i.e. a Hodge decomposition on $A_{\mathbb{C}}^k$, satisfying Hodge symmetry), such that:*

$$A_{\mathbb{C}}^{p,q} \cup A_{\mathbb{C}}^{p',q'} \subset A_{\mathbb{C}}^{p+p',q+q'}.$$

Let us state a number of obvious properties:

1. By Remark 2.3, if A^* admits a Hodge structure, $\dim A^{2k+1}$ is even, $\forall k$.
2. If A^* admits a Hodge structure, then d is even. This follows from 1 because $\dim A^d = 1$ and A^d carries a Hodge structure of weight d .
3. Any cohomology algebra with trivial odd part admits a Hodge structure, namely the trivial one:

$$A_{\mathbb{C}}^{2k} = A^{k,k}, \forall k.$$

Definition 3.3. (Hodge class on A^*) *A Hodge class in A^* is an element of $A^{2k} \cap A^{k,k}$ for some k .*

Hodge classes $a \in A^{2k}$ act by multiplication on A^* , sending A^l to A^{l+2k} . These morphisms are morphisms of Hodge structures, hence “special”. For example, the simplest restriction on them is the following: they are of even rank if l is odd. Indeed, the image of a morphism of Hodge structures is a Hodge substructure (see [48, I,7.3.1]) hence, in particular, of even dimension if it has odd weight (cf. Remark 2.3).

3.0.2. Deligne's lemma. This lemma implies that, given a cohomology algebra A^* , some classes $a \in A^*$ must be Hodge classes for any Hodge structure on A^* .

Let $Z \subset A_{\mathbb{C}}^k$ be a closed algebraic subset defined by homogeneous equations depending only on the structure of multiplication on A^* . Concretely, the following examples will be interesting for applications: fixing l and s , let

$$Z := \{z \in A_{\mathbb{C}}^k, \text{rank } z : A^l \rightarrow A^{l+k} \leq s\}.$$

A second kind of examples is as follows: Fixing l , let

$$Z := \{z \in A_{\mathbb{C}}^k, z^l = 0 \text{ in } A^{kl}\}.$$

Lemma 3.4. (*Deligne*) *Let Z' be an irreducible component of Z , and $V := \langle Z' \rangle \subset A_{\mathbb{C}}^k$ be the complex vector subspace generated by Z' . Then V is stable under Hodge decomposition, i.e. $V = \bigoplus V^{p,q}$, where $V^{p,q} = V \cap A^{p,q}$.*

Corollary 3.5. *Under the same assumptions, if V is defined over \mathbb{Q} , this is a Hodge substructure of A^k .*

Corollary 3.6. *Under the same assumptions, if $\dim V = 1$ and V is defined over \mathbb{Q} , it is generated by a Hodge class.*

3.1. Polarized Hodge structures on cohomology algebras.

Let A^* be a cohomology algebra with Hodge structure.

Definition 3.7. *A Hodge structure on A^* admits a real polarization if some $\alpha \in A_{\mathbb{R}}^{1,1}$ satisfies the hard Lefschetz property and the Hodge-Riemann bilinear relations.*

We will say that the Hodge structure on A^* admits a rational polarization if furthermore α can be chosen in $A_{\mathbb{Q}}^2 \cap A^{1,1}$.

Here the hard Lefschetz property and the Hodge-Riemann bilinear relations are the analogs of their geometric counterparts described in section 2.2. The hard Lefschetz property implies formally the Lefschetz decomposition (cf. [48, I,6.2.2]): $A_{\mathbb{R}}^k = \bigoplus_{k-2r \geq 0} \alpha^r A_{\mathbb{R}, \text{prim}}^{k-2r}$, $k \leq n$, $2n = \dim A^*$. When α is real of type $(1, 1)$ with respect to a Hodge structure on A^* , this is a decomposition into real Hodge sub-structures thus giving a *Hodge-Lefschetz decomposition* of $A_{\mathbb{C}}^k$ into terms of type $\alpha^r A_{\text{prim}}^{p,q}$, $2r + p + q = k$.

The Hodge-Riemann relations (cf. Theorem 2.12) say in this context that

$$h_{\alpha}(a, b) := \iota^k \alpha^{n-k} \cdot a \cdot \bar{b} \in A_{\mathbb{C}}^{2n} \cong \mathbb{C} \alpha^n$$

has a definite sign $\epsilon(p, q, r)$ on each piece of this Hodge-Lefschetz decomposition.

In the rest of this section, we are going to apply these notions to prove the following results:

1. There are very simple examples of compact symplectic manifolds satisfying all the “classical” restrictions (i.e they are formal, satisfy the hard Lefschetz property, have abelian fundamental group), but which are topologically non Kähler (that is, are not homotopically equivalent to a compact Kähler manifold). Such manifolds can be constructed as complex projective bundles over complex tori.
2. (The Kodaira problem) There exist compact Kähler manifolds which are not homeomorphic (and, in fact, not homotopically equivalent) to complex projective manifolds.

The criterion that we will use to prove that the constructed examples as in 1 are topologically non Kähler is the following:

Criterion 3.8. *The cohomology algebra of a compact Kähler manifold carries a Hodge structure. (We can also use as a strengthened criterion the existence of a Hodge structure with real polarization to get more sophisticated examples, eg simply connected examples).*

The criterion that we will use to prove that the constructed examples as in 2 are topologically non projective is the following version of criterion 3.8, where the rational polarization plays now a crucial role, as in Kodaira’s embedding Theorem 1.3:

Criterion 3.9. *The cohomology algebra of a complex projective manifold carries a Hodge structure with rational polarization.*

3.2. Symplectic versus Kähler manifolds. There is a close geometric relation between symplectic geometry and Kähler geometry. If X is compact Kähler, forgetting the complex structure on X and keeping a Kähler form provides a pair (X, ω) which is a symplectic manifold.

On the other hand, numerous topological restrictions are satisfied by compact Kähler manifolds, and not by general symplectic manifolds (cf. [44]). For example, very strong restrictions on fundamental groups of compact Kähler manifolds have been found (see [2]) while Gompf proves in [24] that fundamental groups of compact symplectic manifolds are unrestricted in the class of finitely generated groups.

Hodge theory provides two classical restrictions which come directly from what we discussed in section 2.

1. The odd degree Betti numbers $b_{2i+1}(X)$ are even for X compact Kähler (see Remark 2.3).
2. The hard Lefschetz property (cf. Theorem 2.10), saying that the cup-product maps $[\omega]^{n-k} \cup : H^k(X, \mathbb{R}) \cong H^{2n-k}(X, \mathbb{R})$, $2n = \dim_{\mathbb{R}} X$ are isomorphisms, is satisfied.

Another topological restriction on compact Kähler manifolds is the so-called formality property [17]. A number of methods to produce examples of symplectic topologically non Kähler manifolds were found by Thurston [43], McDuff [34], Gompf [24]. On these examples, one of the properties above was not satisfied.

We want to exhibit here further topological restrictions on compact Kähler manifolds, coming from Criterion 3.8. One of the difficulties to exploit this criterion is the fact that the $h^{p,q}$ -numbers of the Hodge decomposition are not determined topologically. Thus we have to analyse abstractly the constraints imposed by the existence of a polarized Hodge structure on the cohomology algebra without knowing the $h^{p,q}$ -numbers or the set of polarization classes. Let us give a sample of results in this direction. The proofs, which are purely algebraic, are all based on Deligne's lemma 3.4.

We start with an orientable compact manifold X and consider a complex vector bundle E on X . We denote by $p : \mathbb{P}(E) \rightarrow X$ the corresponding projective bundle.

We make the following assumptions on (X, E) :

$$H^*(X) \text{ generated in degree } \leq 2 \text{ and } c_1(E) = 0.$$

As a consequence of Leray-Hirsch theorem, one has an injection (of algebras) $p^* : H^k(X, \mathbb{Q}) \hookrightarrow H^k(\mathbb{P}(E), \mathbb{Q})$ (cf. [48, 7.3.3]).

Theorem 3.10. [54] *If $H^*(\mathbb{P}(E), \mathbb{Q})$ admits a Hodge structure, then each subspace $H^k(X, \mathbb{C}) \subset H^k(\mathbb{P}(E), \mathbb{C})$ has an induced Hodge decomposition (and thus the cohomology algebra $H^*(X, \mathbb{Q})$ also admits a Hodge structure).*

Furthermore each $c_i(E) \in H^{2i}(X, \mathbb{Q})$, $i \geq 2$, is of type (i, i) for this Hodge structure on $H^{2i}(X, \mathbb{Q})$.

This allows the construction of symplectic manifolds with abelian fundamental group satisfying formality (cf [17]) and the hard Lefschetz property, but not having the cohomology algebra of a compact Kähler manifold. These manifolds are produced as complex projective bundles over compact Kähler manifolds (eg complex tori), which easily implies that all the properties above are satisfied. We start with a compact Kähler manifold X having a given class $\alpha \in H^4(X, \mathbb{Q})$ such that for any Hodge structure on $H^*(X, \mathbb{Q})$, α is not of type $(2, 2)$. Then if E is any complex vector bundle on X satisfying $c_1(E) = 0$, $c_2(E) = N\alpha$, for some integer $N \neq 0$, $\mathbb{P}(E)$ is topologically non Kähler by Theorem 3.10, using Criterion 3.8.

The simplest example of such a pair (X, α) is obtained by choosing for X a complex torus of dimension at least 4 and for α a class satisfying the property that the cup-product map $\alpha \cup : H^1(X, \mathbb{Q}) \rightarrow H^5(X, \mathbb{Q})$ has odd rank. Indeed, if α was Hodge for some Hodge structure on the cohomology algebra of X , this morphism would be a morphism of Hodge structures, and its kernel would be a Hodge substructure of $H^1(X, \mathbb{Q})$, hence of even rank by Remark 2.3.

3.3. Kähler versus projective manifolds. Kodaira's characterization Theorem 1.3 can be used to show that certain compact Kähler manifolds X become projective after a small deformations of their complex structure. The point is that the Kähler classes belong to $H^{1,1}(X)_{\mathbb{R}}$, the set of degree 2 cohomology classes which can be represented by a real closed $(1,1)$ -form. They even form an open cone, the Kähler cone, in this real vector subspace of $H^2(X, \mathbb{R})$. This subspace deforms differentiably with the complex structure, and by Kodaira's criterion we are reduced to see whether one can arrange that, after a small deformation, the Kähler cone contains a rational cohomology class.

Example 3.11. Complex tori admit arbitrarily small deformations which are projective.

The following beautiful theorem of Kodaira is at the origin of the work [49].

Theorem 3.12. [33] *Let S be a compact Kähler surface. Then there is an arbitrarily small deformation of the complex structure on S which is projective.*

Kodaira proved this theorem using his classification of complex surfaces. Buchdahl ([10], [11]) gives a proof of Kodaira theorem which does not use the classification. His proof is infinitesimal and shows for example that a rigid compact Kähler surface is projective.

3.3.1. Various forms of the Kodaira problem. Kodaira's theorem 3.12 immediately leads to ask a number of questions in higher dimensions:

Question 3.13. *(The Kodaira problem) Does any compact Kähler manifold admit an arbitrarily small deformation which is projective?*

In order to disprove this, it suffices to find rigid Kähler manifolds which are not projective. However, the paper [21] shows that it is not so easy: if a complex torus T carries three holomorphic line bundles L_1, L_2, L_3 such that the deformations of T preserving the L_i are trivial, then T is projective. The relation with the previous problem is the fact that from (T, L_1, L_2, L_3) , one can construct a compact Kähler manifold whose deformations identify to the deformations of the quadruple (T, L_1, L_2, L_3) .

A weaker question concerns global deformations.

Question 3.14. *(The global Kodaira problem) Does any compact Kähler manifold X admit a deformation which is projective?*

Here we consider any deformation parameterized by a connected analytic space B , that is any smooth proper map $\pi : \mathcal{X} \rightarrow B$ between connected analytic spaces, with $X_0 = X$ for some $0 \in B$. Then any fiber X_t will be said to be a deformation of X_0 . In that case, even the existence of rigid Kähler manifolds which are not projective would not suffice to provide a negative answer, as there exist families of compact Kähler manifolds $\pi : \mathcal{X} \rightarrow B$ all of whose fibers X_t for $t \neq 0$ are isomorphic but are not isomorphic to the central fiber X_0 .

Note that if X is a deformation of Y , then X and Y are diffeomorphic, because the base B is path connected, and by the Ehresmann theorem (cf. [48, 9.1.1]), the family of deformations $\mathcal{X} \rightarrow B$ can be trivialized in the C^∞ -category over any path in B .

In particular, X and Y should be homeomorphic, hence have the same homotopy type, hence also the same cohomology ring. Thus Question 2 can be weakened as follows:

Question 3.15. *(The topological Kodaira problem) Is any compact Kähler manifold X diffeomorphic or homeomorphic to a projective complex manifold?*

Does any compact Kähler manifold X have the homotopy type of a projective complex manifold?

The following theorem answers negatively the questions above.

Theorem 3.16. *There exist, in any complex dimension ≥ 4 , compact Kähler manifolds which do not have the rational cohomology algebra of a projective complex manifold.*

Our first proof used the integral cohomology ring. Deligne provided then us with lemma 3.4, which allowed him to extend the result to cohomology with rational coefficients, and even, after modification of our original example, complex coefficients, (see [49]). We in turn used this lemma to construct simply connected examples.

The examples in [49] were built by blowing-up in an adequate way compact Kähler manifolds which had themselves the property of deforming to projective ones, namely self-products of complex tori, or self-products of Kummer varieties. This left open the possibility suggested by Buchdahl, Campana and Yau, that under bimeromorphic transformations, the topological obstructions we obtained above for a Kähler manifold to admit a projective complex structure would disappear. However we proved in [50] the following result.

Theorem 3.17. *In dimensions ≥ 10 , there exist compact Kähler manifolds, no smooth bimeromorphic model of which has the rational cohomology algebra of a projective complex manifold.*

The following questions remain open (cf. [30]):

1. What happens in dimension 3?
2. Do there exist compact Kähler manifolds whose π_1 is not isomorphic to the π_1 of a complex projective manifold ? (See [55] for one step in this direction.)
3. Is it true that a compact Kähler manifold with nonnegative Kodaira dimension has a bimeromorphic model which deforms to a complex projective manifold?

3.3.2. Construction of examples. The simplest example of a topologically non projective compact Kähler manifold is based on the existence of endomorphisms of complex tori which prevent the complex tori in question to be algebraic. Let Γ be a rank $2n$ lattice, and let ϕ be an endomorphism of Γ . Assume that the eigenvalues of ϕ are all distinct and none is real. Choosing n of these eigenvalues $\lambda_1, \dots, \lambda_n$, so that no two of them are complex conjugate to each other, one can then define $\Gamma^{1,0} \subset \Gamma_{\mathbb{C}}$ as the eigenspace associated to the λ_i 's, and $T = \Gamma_{\mathbb{C}}/(\Gamma^{1,0} \oplus \Gamma)$. Clearly, the extended endomorphism $\phi_{\mathbb{C}}$ of $\Gamma_{\mathbb{C}}$ preserves both $\Gamma^{1,0}$ and Γ , and thus descends to an endomorphism ϕ_T of T .

Our first example was the following. Let (T, ϕ_T) be as above a complex torus with endomorphism. Inside $T \times T$, we have the four subtori

$$T_1 = T \times 0, T_2 = 0 \times T, T_3 = \text{Diagonal}, T_4 = \text{Graph}(\phi_T),$$

which are all isomorphic to T . These tori meet pairwise transversally in finitely many points x_1, \dots, x_N . Blowing-up these points, the proper transforms \tilde{T}_i are smooth and do not meet anymore. We can thus blow-up all the \tilde{T}_i 's to get a compact Kähler manifold X . This is our example.

Theorem 3.18. [49] *This compact Kähler manifold X does not have the cohomology algebra of a projective complex manifold. More precisely, the cohomology algebra $H^*(X, \mathbb{Q})$ does not admit a Hodge structure with rational polarization.*

Let us give an idea of the proof. The degree 2 cohomology of the manifold X contains the classes e_i of the exceptional divisors over the \tilde{T}_i . The first step is to use Deligne's Lemma 3.4, or rather its corollary 3.6 to show that these classes have to be Hodge classes for any Hodge structure on $H^*(X, \mathbb{Q})$. The second step consists then in examining the morphisms of Hodge structures

$$\cup e_i : H^1(X, \mathbb{Q}) \rightarrow H^3(X, \mathbb{Q})$$

given by cup-product with the e_i 's. The conclusion is the following: For any Hodge structure on $H^*(X, \mathbb{Q})$, the weight 1 Hodge structure on $H^1(X, \mathbb{Q})$ is the direct sum of two copies of a weight 1 Hodge structure L , which admits an endomorphism conjugate to ${}^t\phi$. One concludes then with the following easy result:

Proposition 3.19. [49] *If $n \geq 2$ and the Galois group of the splitting field of $\mathbb{Q}(\phi)$ acts as the full symmetric group \mathfrak{S}_{2n} on the eigenvalues of ϕ , then a weight 1 Hodge structure admitting an endomorphism conjugate to ${}^t\phi$ does not admit a rational polarization.*

4. Cohomology of Algebraic Varieties; Algebraic Data

4.1. Algebraic de Rham cohomology. Let X be a smooth projective variety defined over a field K of characteristic 0. One has the sheaf of

Kähler (or algebraic) differentials $\Omega_{X/K}$ which is a locally free algebraic coherent sheaf on X , locally generated by differentials df_i , where the f_i are algebraic functions on X defined near x , the relations being given by $da = 0$, $a \in K$ and Leibniz rule $d(fg) = fdg + gdf$.

We can form the locally free sheaves $\Omega_{X/K}^l := \bigwedge^l \Omega_{X/K}$ and, by the definition of $\Omega_{X/K}$ and using Leibniz rule, we get the differentials $d : \mathcal{O}_X \rightarrow \Omega_{X/K}$, $d : \Omega_{X/K}^l \rightarrow \Omega_{X/K}^{l+1}$ satisfying $d \circ d = 0$.

Definition 4.1. *The algebraic de Rham cohomology of X is defined as the hypercohomology of the algebraic de Rham complex: $H_{dR}^k(X/K) := \mathbb{H}^k(X, \Omega_{X/K}^*)$.*

Note that this finite dimensional K -vector space depends on K . However, when $K \subset L$ (field extension), one has $H_{dR}^k(X_L/L) = H_{dR}^k(X/K) \otimes_K L$. This construction led Grothendieck to the following remarkable conclusion: The cohomology with *complex* coefficients of a smooth complex projective variety (endowed with its classical topology) X_{cl} can be computed as an algebraic invariant of the algebraic variety X .

Note that this is not at all true if we change the field of coefficients or the definition field. Even with \mathbb{R} instead of \mathbb{C} , and even if the variety X is defined over \mathbb{R} , the cohomology $H^*(X_{cl}, \mathbb{R})$ cannot be computed by algebraic means. It is furthermore known by work of Serre (see also [13], [40] for further refined versions of this phenomenon) that the homotopy types (and even the real cohomology algebra) of X_{cl} indeed is not determined by the abstract algebraic variety X . In fact, a field automorphism of \mathbb{C} will provide another complex algebraic variety, thus another complex manifold, which is usually not homeomorphic or even homotopically equivalent to the original one.

The precise statement of Grothendieck's Theorem is the following:

Theorem 4.2. [29] *Let X be a smooth algebraic variety defined over \mathbb{C} . Then there is a canonical isomorphism*

$$H_{dR}^k(X/\mathbb{C}) = H^k(X_{cl}, \mathbb{C}). \quad (4.3)$$

When X is projective, this is a direct consequence of Serre's theorem 1.4 and of the fact that the *holomorphic* de Rham complex Ω_X^* , which is the analytic counterpart of the algebraic de Rham complex, is a resolution of the constant sheaf \mathbb{C} on X_{cl} . The quasi-projective case involves a projective completion \overline{X} of X with a boundary $D = \overline{X} \setminus X$ which is a *normal crossing divisor*, and the introduction of the logarithmic (algebraic and holomorphic) de Rham complexes $\Omega_X^*(\log D)$.

Remark 4.3. What makes Theorem 4.2 striking is the fact that the algebraic de Rham complex, unlike the holomorphic de Rham complex in the classical topology, is not at all acyclic in positive degree in the Zariski topology, so that the proof above is completely indirect. In fact, by the affine version of Theorem 4.2, its degree i cohomology sheaf is the complexified version of the sheaf \mathcal{H}^i studied by Bloch and Ogus [8], (cf. Section 4.4).

4.1.1. Cycle classes. Let X be a smooth projective variety defined over K and $Z \subset X$ be a local complete intersection closed algebraic subset of X , also defined over K . Following Bloch [7], one can construct an algebraic cycle class

$$[Z]_{alg} \in H_{dR}^{2k}(X/K).$$

Assume now that X is defined over \mathbb{C} . We denote by $Hdg^{2k}(X)$ the set of Hodge classes of the corresponding complex manifold. This is naturally a subspace of $H^{2k}(X_{cl}, \mathbb{Q})$, hence of $H^{2k}(X_{cl}, \mathbb{C})$. We mentioned in section 2.1 that one can define for any closed algebraic or analytic subset $Z \subset X$ of codimension k a topological cycle class $[Z] \in Hdg^{2k}(X)$. The following result compares the algebraic and topological constructions.

Theorem 4.4. *Via the isomorphism (4.3) in degree $2k$, one has*

$$[Z]_{alg} = (2\iota\pi)^k [Z].$$

Remark 4.5. The coefficient $(2\iota\pi)^k$ is not formal there, or just a matter of definition. It is forced on us, due to the fact that the algebraic cycle class is compatible with definition fields (eg, if Z, X are defined over K , so is $[Z]_{alg}$), while the topological cycle class is rational for the Betti cohomology theory.

4.2. Absolute Hodge classes. Here we enter one of the most fascinating aspects of the Hodge conjecture, which seriously involves the fact that the complex manifolds we are considering are algebraic.

Let us first introduce the notion of (de Rham) absolute Hodge class (cf. [19]). First of all, let us make a change of definition: a Hodge class of degree $2k$ on X will be in this section a class $\alpha \in (2\iota\pi)^k H^{2k}(X, \mathbb{Q}) \cap H^{k,k}(X)$. The reason for this shift is the fact that we want to use the algebraic cycle class $[Z]_{alg}$ introduced in section 4.1.1, which takes value in algebraic de Rham cohomology, and which, by Theorem 4.4, equals $(2\iota\pi)^k [Z]$ via the isomorphism (4.3).

Let X_{cl} be a complex projective manifold endowed with its classical topology and $\alpha \in Hdg^{2k}(X)$ be a Hodge class. Thus $\alpha \in (2\iota\pi)^k H^{2k}(X_{cl}, \mathbb{Q}) \subset H^{2k}(X_{cl}, \mathbb{C})$ and we can use Theorem 4.2 to compute the right hand side as the hypercohomology of the algebraic variety X with value in the complex of algebraic differentials:

$$H^{2k}(X_{cl}, \mathbb{C}) \cong \mathbb{H}^{2k}(X, \Omega_{X/\mathbb{C}}^*). \tag{4.4}$$

For each field automorphism σ of \mathbb{C} , we get a new algebraic variety X_σ defined over \mathbb{C} , obtained from X by applying σ to the coefficients of the defining equations of X . The corresponding complex manifold $X_{\sigma,cl}$ is called a “conjugate variety” of X_{cl} (cf. [39]). It is in general not homotopically equivalent to X_{cl} . However, as an algebraic variety, X_σ is deduced from X by applying σ , and it follows that there is a natural (only $\sigma(\mathbb{C})$ -linear) isomorphism between algebraic de Rham cohomology groups:

$$\mathbb{H}^{2k}(X, \Omega_{X/\mathbb{C}}^*) \cong \mathbb{H}^{2k}(X_\sigma, \Omega_{X_\sigma/\mathbb{C}}^*).$$

Applying the comparison isomorphism (4.4) in the reverse way, the class α thus provides for each σ a (de Rham or Betti) complex cohomology class

$$\alpha_\sigma \in \mathbb{H}^{2k}(X_\sigma, \Omega_{X_\sigma}^*) = H^{2k}(X_{\sigma, cl}, \mathbb{C}).$$

Definition 4.6. (cf [19]) *The class α is said to be (de Rham) absolute Hodge if α_σ is a Hodge class for each σ . Concretely, as α_σ has the right Hodge type, it suffices to check that $\alpha_\sigma = (2\iota\pi)^k \beta_\sigma$, for some rational cohomology class $\beta_\sigma \in H^{2k}(X_{\sigma, cl}, \mathbb{Q})$.*

The main reason for introducing this definition is the following, which is an immediate consequence of the comparison theorem 4.4 and of the naturality of the algebraic cycle class:

Proposition 4.7. *If $Z \subset X$ is an algebraic subvariety of codimension k , then $(2\iota\pi)^k [Z] \in (2\iota\pi)^k H^{2k}(X, \mathbb{Q})$ is an absolute Hodge class.*

Proposition 4.7 shows that the Hodge conjecture contains naturally the following subconjectures:

Conjecture 4.8. *Hodge classes on smooth complex projective varieties are absolute Hodge.*

Conjecture 4.9. *Let X be smooth complex projective. Absolute Hodge classes on X are generated over \mathbb{Q} by algebraic cycles classes.*

Conjecture 4.8 is solved affirmatively by Deligne for Hodge classes on abelian varieties (cf. [19]). An important but easy point in this proof is the fact that Weil classes (cf. section 2.1) on Weil abelian varieties are absolute Hodge.

To conclude this section, let us mention a crucial example of absolute Hodge class. It plays an important role in the theory of algebraic cycles (cf. [31]) and is not known in general to be algebraic (that is to satisfy the Hodge conjecture).

Example 4.10. Let X be smooth projective of dimension n . Recall from Theorem 2.10 that if $h = c_1(H)$, where H is an ample line bundle on X , there is for each $k \leq n$ an isomorphism of Hodge structures $h^{n-k} \cup : H^k(X, \mathbb{Q}) \cong H^{2n-k}(X, \mathbb{Q})$. Consider now the inverse of the Lefschetz isomorphism above: $(h^{n-k} \cup)^{-1} : H^{2n-k}(X, \mathbb{Q}) \cong H^k(X, \mathbb{Q})$. By Poincaré duality and Künneth decomposition, the space $\text{Hom}(H^{2n-k}(X, \mathbb{Q}), H^k(X, \mathbb{Q}))$ is contained in $H^{2k}(X \times X, \mathbb{Q})$. The corresponding Hodge of degree $2k$ on $X \times X$ is absolute Hodge, and is not known in general to be algebraic.

4.3. Hodge loci and absolute Hodge classes. The key point in which algebraic geometry differs from Kähler geometry is the fact that a smooth complex projective variety X does not come alone, but accompanied by a full family of deformations $\pi : \mathcal{X} \rightarrow T$, where π is smooth and projective (that is $\mathcal{X} \subset T \times \mathbb{P}^N$ over T , for some integer N), and where the base T is quasi-projective smooth and defined over \mathbb{Q} (T is not supposed to be geometrically

irreducible). Indeed, one can take for T a desingularization of a Zariski open set of the reduced Hilbert scheme parameterizing subschemes of \mathbb{P}^N with same Hilbert polynomial as X . The Hilbert scheme and its universal family are known to be defined over \mathbb{Q} . The existence of this family of deformations is reflected in the transformations $X \mapsto X_\sigma$ considered above. Namely, the variety T being defined over \mathbb{Q} , σ acts on its complex points, and if X is the fiber over some complex point $0 \in T(\mathbb{C})$, then X_σ is the fiber over the complex point $\sigma(0)$ of $T(\mathbb{C})$.

The total space \mathcal{X} is thus an algebraic variety defined over \mathbb{Q} (and in fact we may even complete it to a smooth projective variety defined over \mathbb{Q}), but for the moment, let us consider it as a family of smooth complex varieties, that is, let us work with $\pi : \mathcal{X}_{cl} \rightarrow T_{cl}$.

Associated to this family are the Hodge bundles H^l on T , which are described set theoretically as follows: $H^l = \{(t, \alpha_t), t \in T, \alpha_t \in H^l(X_t, \mathbb{C})\}$. Using a relative version of Grothendieck’s theorem 4.2, one can show that H^l is an algebraic vector bundle on T , defined over \mathbb{Q} .

Definition 4.11. (cf [12]) *The locus of Hodge classes for the family $\mathcal{X} \rightarrow T$ and in degree $2k$ is the subset $Z \subset H^{2k}$ consisting of pairs (t, α) where $t \in T(\mathbb{C})$ and α_t is a Hodge class on X_t .*

This locus is thus the set of all Hodge classes in fibers of π . For $\alpha \in Z$ we shall denote by Z_α the connected component of Z passing through α and by T_α the projection of Z_α to T . T_α is the Hodge locus of α , that is the locus of deformations of X where α deforms as a Hodge class.

Observing that the transport map $H^l(X_t, \mathbb{C}) \ni \alpha_t \mapsto \alpha_{t,\sigma} \in H^l(X_{t,\sigma}, \mathbb{C})$ associated to a field automorphism σ of \mathbb{C} in the previous section is nothing but the action of $Aut \mathbb{C}$ on the complex points of the total space of the vector bundle H^l , seen as a variety defined over \mathbb{Q} , we get the following “geometric” interpretation of the notion of absolute Hodge class.

Lemma 4.12. (cf. [52]) *i) To saying that Hodge classes of degree $2k$ on fibers of the family $\mathcal{X} \rightarrow T$ are absolute Hodge is equivalent to say that the locus Z is a countable union of closed algebraic subsets of H^{2k} defined over \mathbb{Q} .*

ii) To saying that $\alpha \in Hdg^{2k}(X)$ is an absolute Hodge class is equivalent to say that Z_α is a closed algebraic subset of H^{2k} defined over $\overline{\mathbb{Q}}$ and that its images under $Gal(\overline{\mathbb{Q}} : \mathbb{Q})$ are again components of the locus of Hodge classes.

This lemma rephrases Conjecture 4.8 as a structure statement for the locus of Hodge classes. The following result, due to Cattani, Deligne and Kaplan, establishes part of the predicted structure of the locus of Hodge classes. It is a strong evidence for Conjecture 4.8, hence for the Hodge conjecture itself.

Theorem 4.13. [12] *The connected components Z_α of Z are closed algebraic subsets of H^{2k} . Hence the Hodge loci T_α are closed algebraic subsets of T .*

Let us now investigate the arithmetic aspect of the notion of absolute Hodge class, exploiting its relation with the definition field of the component of the

Hodge loci. The following result is obtained in [52] as a consequence of Deligne's global invariant cycle theorem (cf. [18]). This result says that for absolute Hodge classes, or under the much weaker assumption ii), the Hodge conjecture can be reduced to the case of Hodge classes on varieties defined over a number field.

Theorem 4.14. [52] *i) Let $\alpha \in \text{Hdg}^{2k}(X)$ be an absolute Hodge class. Then the Hodge conjecture is true for α if it is true for absolute Hodge classes on varieties defined over $\overline{\mathbb{Q}}$.*

ii) Let $\alpha \in \text{Hdg}^{2k}(X)$ be a Hodge class, such that the Hodge locus T_α is defined over $\overline{\mathbb{Q}}$. Then the Hodge conjecture is true for α if it is true for Hodge classes on varieties defined over $\overline{\mathbb{Q}}$.

The second statement of Theorem 4.14 is one motivation to investigate the question whether the Hodge loci T_α are defined over $\overline{\mathbb{Q}}$, which by Lemma 4.12 is weaker than the question whether Hodge class are absolute.

We have the following criterion, proved in [52]:

Theorem 4.15. *Let $\alpha \in H^{2k}(X, \mathbb{C})$ be a Hodge class. Suppose that any locally constant Hodge substructure defined along T_α , say $L \subset H^{2k}(X_t, \mathbb{Q})$, $t \in T_\alpha$, is purely of type (k, k) . Then T_α is defined over $\overline{\mathbb{Q}}$, and its translates under $\text{Gal}(\overline{\mathbb{Q}}/\mathbb{Q})$ are again of the form T_β .*

The assumptions in the theorem are reasonably easy to check in practice, for example by infinitesimal methods. On the other hand, they are clearly not satisfied in the case where the component T_α of the Hodge locus consists of one isolated point, if the Hodge structure on $H^{2k}(X)$ is not trivial. In this case, what predicts the Hodge conjecture is that this point should be defined over $\overline{\mathbb{Q}}$. But our criterion does not give this: in fact our criterion applies only when we actually have a non trivial variation of Hodge structure along T_α .

4.4. Bloch-Ogus theory and K-theory. Let X be a smooth complex algebraic variety. As before X_{cl} denotes $X(\mathbb{C})$ endowed with the classical topology, while X_{Zar} denotes $X(\mathbb{C})$ endowed with the Zariski topology. We denote $\pi : X_{cl} \rightarrow X_{Zar}$ the identity map, which is continuous. Bloch-Ogus theory is the study of the spectral sequence associated to π . It appears to be one of the best ways to relate the cohomology of X_{cl} to the structure of its spaces of subvarieties or rather algebraic cycles.

Let us start with a notation: Let A be an abelian group; the sheaves $\mathcal{H}_X^i(A)$ are the sheaves on X_{Zar} defined by $\mathcal{H}_X^i(A) := R^i \pi_* A$. More concretely, $\mathcal{H}_X^i(A)$ is the sheaf on X_{Zar} associated to the presheaf $U \mapsto H^i(U_{cl}, A)$. The Leray spectral sequence for π starts at E_2

$$E_2^{p,q} = H^p(X_{Zar}, \mathcal{H}_X^q(A)) \Rightarrow H^{p+q}(X_{cl}, A).$$

There is one simple thing that can be said about the sheaves $\mathcal{H}_X^i(A)$: namely they vanish for $i > n = \dim_{\mathbb{C}} X$. Indeed, this is a consequence of the fact that

the homotopy type of a smooth complex affine algebraic variety of dimension n is a CW complex of real dimension $\leq n$ (cf. [48, II,1.2.1]).

However, much more can be said about the shape of the above spectral sequence, as a consequence of Bloch-Ogus theorem providing a Gersten-Quillen's type resolution for the sheaves \mathcal{H}_X^i .

Theorem 4.16. (Bloch-Ogus, [8]) *One has $H^p(X_{Zar}, \mathcal{H}_X^q(A)) = 0$ for $p > q$.*

Another spectacular consequence of this resolution is the following formula due to Bloch-Ogus for groups of cycles modulo algebraic equivalence:

Theorem 4.17. [8] *One has, for any $p \geq 0$, the formula $H^p(X_{Zar}, \mathcal{H}^p(\mathbb{Z})) = \mathcal{Z}^p(X)/\text{alg}$.*

Here $\mathcal{Z}^p(X)$ is the free abelian group with basis the irreducible closed algebraic subsets of X of codimension p . The algebraic equivalence relation is generated by the deformation relation: two closed algebraic subsets of X are deformation equivalent if they are the fibers over two points of a codimension p closed algebraic subset $\mathcal{Z} \subset C \times X$, parameterized by a smooth connected curve C .

Finally, the most impressive applications of Bloch-Ogus theory are obtained via the Bloch-Kato conjecture which had been partially established by Merkur'ev and Suslin in [35], [36], by Voevodsky in [46], and is now fully announced by Voevodsky [45]. This conjecture relates Milnor K -theory of a field modulo n to Galois cohomology of this field with twisted $\mathbb{Z}/n\mathbb{Z}$ -coefficients. Combined with Bloch-Ogus resolution for finite coefficients and in the étale setting on one hand, and with the Gersten-Quillen resolution for K -theory on the other hand, it leads to beautiful results concerning groups of algebraic cycles modulo certain equivalence relations, and more precisely to their torsion part or their version with finite coefficients (we refer to [15], [37] for reviews of them).

The following beautiful consequence of Bloch-Kato conjecture was obtained by Bloch and Srinivas [6].

Theorem 4.18. *The Bloch-Kato conjecture implies that the sheaves $\mathcal{H}_X^i(\mathbb{Z})$ have no torsion, which is also equivalent to the fact that for any i and n , there are exact sequences:*

$$0 \rightarrow \mathcal{H}_X^i(\mathbb{Z}) \xrightarrow{n} \mathcal{H}_X^i(\mathbb{Z}) \rightarrow \mathcal{H}_X^i(\mathbb{Z}/n\mathbb{Z}) \rightarrow 0.$$

Let us state a simple application, which is related to the defect of the Hodge conjecture for integral Hodge classes (already observed by Atiyah and Hirzebruch [3] in 1962). We introduce first the following invariant, which is shown in [14] to be a birational invariant, allowing to detect non rationality of certain unirational varieties. Here we use the following notions: A *rational* variety is birationally equivalent to a projective space, while a *unirational* variety X admits a rational dominating map $\mathbb{P}^N \dashrightarrow X$. Deciding whether a unirational

variety is rational or not is a version of the Lüroth problem, which has a long history [5].

Definition 4.19. *The i -th unramified cohomology group of X with coefficients in A is defined by the formula $H_{nr}^i(X, A) = H^0(X_{Zar}, \mathcal{H}_X^i(A))$.*

On the other hand, the defect of the integral Hodge conjecture for X is measured by the groups $Z^{2i}(X) := \text{Hdg}^{2i}(X, \mathbb{Z}) / \langle [Z], \text{codim } Z = i \rangle$. The group $Z^4(X)$ was shown by Kollár to be non trivial for very general hypersurfaces of high degree in \mathbb{P}^4 . However it was shown in [51] that $Z^4(X)$ is trivial if X is a threefold swept-out by rational curves, i.e curves isomorphic to \mathbb{P}^1 . In higher dimensions, the question whether $Z^4(X) = 0$ for rationally connected varieties (i.e. varieties for which any two points can be joined by a rational curve) was asked in [53]. We disprove this using the main result of [14] and comparing $H_{nr}^3(X, \mathbb{Z}/n\mathbb{Z})$ and the n -torsion of $Z^4(X)$ (see also [4]).

Theorem 4.20. [16] *There exist rationally connected (and even unirational) varieties of dimension 6 for which $Z^4(X) \neq 0$.*

References

- [1] Y. ANDRÉ. *Une introduction aux motifs (motifs purs, motifs mixtes, périodes)* (in French), Panoramas et Synthèses **17**, Société Mathématique de France, Paris, (2004).
- [2] J. AMORÓS, M. BURGER, K. CORLETTE, D. KOTSCHICK, D. TOLEDO. *Fundamental groups of compact Kähler manifolds*, Mathematical Surveys and Monographs, **44**. American Mathematical Society, Providence, RI, (1996).
- [3] M. ATIYAH, F. HIRZEBRUCH. Analytic cycles on complex manifolds, *Topology* **1** (1962), 25–45.
- [4] L. BARBIERI-VIALE. Cicli di codimensione 2 su varietà unirazionali complesse, in *K-Theory*, Strasbourg 1992, Astérisque **226** (1994), 13–41.
- [5] A. BEAUVILLE. Variétés rationnelles et unirationnelles, in *Algebraic geometry—open problems* (Ravello, 1982), Lecture Notes in Mathematics **997** (1983), 16–33, Springer-Verlag Berlin.
- [6] S. BLOCH AND V. SRINIVAS. Remarks on correspondences and algebraic cycles, *Amer. J. of Math.* **105** (1983), 1235–1253.
- [7] S. BLOCH. Semi-regularity and de Rham cohomology, *Invent. Math.* **17** (1972), 51–66.
- [8] S. BLOCH, A. OGUS. Gersten’s conjecture and the homology of schemes, *Ann. Sci. Éc. Norm. Supér.* **7** (1974), 181–201.
- [9] A. BOREL, J.-P. SERRE. Le théorème de Riemann-Roch (d’après Grothendieck), *Bull. Soc. Math. France* **86** (1958), 97136.
- [10] N. BUCHDAHL. Algebraic deformations of compact Kähler surfaces, *Math. Z.* **253** (2006), 453–459.

- [11] N. BUCHDAHL. Algebraic deformations of compact Kähler surfaces. II, *Math. Z.* **258** (2008), 493–498.
- [12] E. CATTANI, P. DELIGNE, A. KAPLAN. On the locus of Hodge classes, *J. Amer. Math. Soc.* **8** (1995), 483–506.
- [13] F. CHARLES. Conjugate varieties with distinct real cohomology algebras, *J. Reine Angew. Math.* **630** (2009), 125–139.
- [14] J.-L. COLLIOT-THÉLÈNE, M. OJANGUREN. Variétés unirationnelles non rationnelles: au-delà de l'exemple d'Artin et Mumford, *Invent. math.* **97** (1989), 141–158.
- [15] J.-L. COLLIOT-THÉLÈNE. Cycles algébriques de torsion et K-théorie algébrique, in *Arithmetic Algebraic Geometry* (CIME, Trento, 1991, E. Ballico, ed.), Springer L.N.M. **1553** (1993), 1–49.
- [16] J.-L. COLLIOT-THÉLÈNE, C. VOISIN. Cohomologie non ramifiée et conjecture de Hodge entière, preprint 2010.
- [17] P. DELIGNE, PH. GRIFFITHS, J. MORGAN, D. SULLIVAN. Real homotopy theory of Kähler manifolds, *Inventiones Math.* **2** (1975), 245–274.
- [18] P. DELIGNE. Théorie de Hodge II, *Publ. Math. IHES* **40**, (1971), 5–57.
- [19] P. DELIGNE. Hodge cycles on abelian varieties (notes by J. S. Milne), in *Lecture Notes in Mathematics* **900** (1982), 9–100, Springer-Verlag.
- [20] P. DELIGNE, PH. GRIFFITHS, J. MORGAN, D. SULLIVAN. Real homotopy theory of Kähler manifolds, *Inventiones Math.* **2** (1975), 245–274.
- [21] J.-P. DEMAILLY, T. ECKL, T. PETERNELL. Line bundles on complex tori and a conjecture of Kodaira, *Comment. Math. Helv.* **80** (2005), no. 2, 229–242.
- [22] G. DE RHAM. Sur l'analysis situs des variétés à n dimensions, *Journal de mathématiques pures et appliquées*, 9e série, **10** (1931), 115–200.
- [23] S. DONALDSON. An application of gauge theory to four-dimensional topology. *J. Differential Geom.* **18** (1983), 279–315.
- [24] R. GOMPF. A new construction of symplectic manifolds, *Ann. of Math.* **142** (1995), 527–595.
- [25] PH. GRIFFITHS, J. MORGAN. *Rational homotopy theory and differential forms*, Progress in Mathematics, **16**. Birkhäuser, Boston, Mass. (1981).
- [26] PH. GRIFFITHS. On the periods of certain rational integrals I,II, *Ann. of Math.* **90** (1969), 460–541.
- [27] P. GRIFFITHS, J. HARRIS. *Principles of algebraic geometry*, Pure and Applied Mathematics. Wiley-Interscience [John Wiley & Sons], New York, (1978).
- [28] J. GRIVAUX. Chern classes in Deligne cohomology for coherent analytic sheaves, *Math. Annalen* **347** (2010), 249–284.
- [29] A. GROTHENDIECK. On the de Rham cohomology of algebraic varieties, *Inst. Hautes Etudes Sci. Publ. Math. No.* **29** (1966), 95–103.
- [30] D. HUYBRECHTS. Projectivity of Kähler manifolds - Kodaira's problem (after C. Voisin), *Séminaire Bourbaki, Exp. N0. 954, Astérisque* **311** (2007), Société Mathématique de France.

-
- [31] S. KLEIMAN. Algebraic cycles and the Weil conjectures, in *Dix exposés sur la cohomologie des schémas*, (1968) 359–386. North-Holland, Amsterdam; Masson, Paris.
- [32] K. KODAIRA. On Kähler varieties of restricted type (an intrinsic characterization of algebraic varieties), *Ann. of Math.* **60** (1954), 28–48.
- [33] K. KODAIRA. On compact complex analytic surfaces, I, *Ann. of Math.* **71** (1960), 111–152.
- [34] D. MCDUFF. Examples of simply connected symplectic non Kaehlerian manifolds, *J. Differential Geom.* **20** (1984), 267–277.
- [35] S. MERKUR'EV, A. A. SUSLIN. On the norm residue symbol of degree 2, (translated from Russian,) *Math. USSR-Izv.* **21** (1983), 307–340.
- [36] S. MERKUR'EV, A. A. SUSLIN. Norm residue homomorphism of degree 3, (translated from Russian,) *Math. USSR-Izv.* **36** (1991), 349–367.
- [37] J. P. MURRE. Applications of algebraic K -theory to the theory of algebraic cycles, in *Proc. Conf. Algebraic Geometry*, Sitjes 1983, *Lecture Notes in Mathematics* **1124** (1985), 216–261, Springer-Verlag.
- [38] J.-P. SERRE. Géométrie algébrique et géométrie analytique, *Ann. Inst. Fourier* **6** (1956), 1–42 .
- [39] J.-P. SERRE. Exemples de variétés projectives conjuguées non homéomorphes, *C. R. Acad. Sci. Paris* **258** (1964), 4194–4196.
- [40] I. SHIMADA. Non-homeomorphic conjugate complex varieties, [arXiv:math/0701115](https://arxiv.org/abs/math/0701115).
- [41] C. SOULÉ AND C. VOISIN. Torsion cohomology classes and algebraic cycles on complex projective manifolds. *Adv. Math.* **198** (2005), 107–127.
- [42] D. SULLIVAN. Infinitesimal computations in topology. *Inst. Hautes Études Sci. Publ. Math.* **47** (1977), 269–331.
- [43] W. THURSTON. Some simple examples of symplectic manifolds, *Proc. Amer. Math. Soc.* **55** (1976), 467–468.
- [44] A. TRALLE, J. OPREA. *Symplectic manifolds with no Kähler structure*, *Lecture Notes in Mathematics* **1661** (1997), Springer-Verlag, Berlin.
- [45] V. VOEVODSKY. On motivic cohomology with \mathbb{Z}/l -coefficients, [arxiv 0805.4430](https://arxiv.org/abs/0805.4430).
- [46] V. VOEVODSKY. Motivic cohomology with $\mathbb{Z}/2$ -coefficients, *Publ. Math. Inst. Hautes Études Sci.* **98** (2003), 59–104.
- [47] C. VOISIN. A counterexample to the Hodge conjecture extended to Kähler varieties, *Int. Math. Res. Not.* No **20** (2002), 1057–1075.
- [48] C. VOISIN. *Hodge Theory and Complex Algebraic Geometry I*, *Cambridge studies in advanced Mathematics* **76**, Cambridge University Press 2002.
- [49] C. VOISIN. On the homotopy types of compact Kähler and complex projective manifolds, *Inventiones Math.* **157** (2004), 329–343.
- [50] C. VOISIN. On the homotopy types of Kähler manifolds and the birational Kodaira problem, *J. Differential Geom.* **72** (2006), 43–71.

-
- [51] C. VOISIN. On integral Hodge classes on uniruled and Calabi-Yau threefolds, in *Moduli Spaces and Arithmetic Geometry*, Advanced Studies in Pure Mathematics **45**, (2006), 43–73.
- [52] C. VOISIN. Hodge loci and absolute Hodge classes, *Compositio Math.* **143** (2007), 945–958.
- [53] C. VOISIN. Some aspects of the Hodge conjecture, *Japan. J. Math.* **2** (2007), 261–296.
- [54] C. VOISIN. Hodge structures on cohomology algebras and geometry. *Math. Ann.* **341** (2008), 39–69.
- [55] B. WANG. Homomorphisms between fundamental groups of Kähler manifolds, preprint 2009, arxiv:0910.5523.
- [56] A. WEIL. Sur les théorèmes de de Rham, *Comment. Math. Helv.* **26** (1952), 119–145.
- [57] A. WEIL. Abelian varieties and the Hodge ring, in *Collected papers*, Vol. III, 421–429, Springer-Verlag (1980).

Strong Axioms of Infinity and the Search for V

W. Hugh Woodin*

Abstract

The axioms ZFC do not provide a concise conception of the Universe of Sets. This claim has been well documented in the 50 years since Paul Cohen established that the problem of the Continuum Hypothesis cannot be solved on the basis of these axioms.

Gödel's Axiom of Constructibility, $V = L$, provides a conception of the Universe of Sets which is perfectly concise modulo only large cardinal axioms which are strong axioms of infinity. However the axiom $V = L$ limits the large cardinal axioms which can hold and so the axiom is *false*. The Inner Model Program which seeks generalizations which are compatible with large cardinal axioms has been extremely successful, but incremental, and therefore by its very nature unable to yield an ultimate enlargement of L . The situation has now changed dramatically and there is, for the first time, a genuine prospect for the construction of an ultimate enlargement of L .

Mathematics Subject Classification (2010). 03–02, 03E05, 03E15, 03E25, 03E35, 03E40, 03E60

1. Introduction

Paul Cohen showed in 1963 that Cantor's problem of the *Continuum Hypothesis* cannot be (formally) solved on the basis of the ZFC axioms for Set Theory. This result and its mathematical descendants have severely challenged any hope for a concise conception of the Universe of Sets.

Gödel's *Axiom of Constructibility*, this is the axiom $V = L$ defined in Section 6, does provide a clear conception of the Universe of Sets—a view that is arguably absolutely concise modulo only *large cardinal axioms* which are strong versions of the *Axiom of Infinity*. A conception of sets, perfectly concise modulo only large cardinal axioms, is clearly the idealized goal of Set Theory. But the axiom $V = L$ limits the large cardinal axioms which can hold and so the axiom is *false*.

*University of California, Berkeley. E-mail: woodin@math.berkeley.edu.

Research supported by the National Science Foundation (US) and the John Templeton Foundation.

The obvious remedy is to seek generalizations of the axiom $V = L$ which are *compatible* with large cardinal axioms. This program has been very successful, producing some of the most fundamental insights we currently have into the Universe of Sets. But at the same time the incremental nature of the program has seemed to be an absolutely fundamental aspect of the program: each new construction of an enlargement of L meeting the challenge of a specific large cardinal axiom comes with a theorem that no *stronger* large cardinal axiom can hold in that enlargement. Since it seems very unlikely that there could ever be a *strongest* large cardinal axiom, this methodology seems unable by its very nature to ever succeed in providing the requisite axiom for clarifying the conception of the Universe of Sets.

The situation has now changed dramatically and there is for the first time a genuine prospect for the construction of an *ultimate* enlargement of L . This arises *not* from the identification of a strongest large cardinal axiom but from the unexpected discovery that at a specific critical stage in the hierarchy of large cardinal axioms, the construction of an enlargement of L compatible with this large cardinal axiom must yield the ultimate enlargement of L . More precisely this construction must yield an enlargement which is compatible with all stronger large cardinal axioms.

In this paper I shall begin with an example which illustrates how large cardinal axioms have been successful in solving questions some of which date back to the early 1900's and which were conjectured at the time to be *absolutely* unsolvable. This success raises a fundamental issue. Can the basic methodology be extended to solve a much wider class of questions such as that of the Continuum Hypothesis?

I shall briefly review the construction of L , the basic template for large cardinal axioms, and describe the program which seeks enlargements of L compatible with large cardinal axioms.

Finally I will introduce Ω -logic, explain how on the basis of the Ω Conjecture a multiverse conception of V is untenable, and review the recent developments on the prospects for an ultimate version of L . I will end by stating an axiom which I conjecture is the axiom that V is this ultimate L even though the definition of this ultimate L is *not yet known*.

This account follows a thread over nearly 100 years but neither it nor the list of references is intended to be comprehensive, see [10] and [18] for far more elegant and thorough accounts.

2. The Projective Sets and Two Questions of Luzin

The projective sets are those sets of real numbers $A \subseteq \mathbb{R}$ which can be generated from the open subsets of \mathbb{R} in finitely many steps of taking complements and

images by continuous functions,

$$f : \mathbb{R} \rightarrow \mathbb{R}.$$

Similarly one defines the projective sets $A \subseteq \mathbb{R}^n$ or one can simply use a borel bijection,

$$\pi : \mathbb{R} \rightarrow \mathbb{R}^n$$

and define $A \subseteq \mathbb{R}^n$ to be projective if the preimage of A by π is projective.

From perspective of set theoretic complexity, projective sets are quite simple and one might expect that their basic properties can be established directly on the basis of the axioms ZFC.

The projective sets were defined by Luzin who posed two basic questions, [13] and [14]. A definition is required. Suppose that $A \subseteq \mathbb{R} \times \mathbb{R}$. A function f *uniformizes* A if for all $x \in \mathbb{R}$, if there exists $y \in \mathbb{R}$ such that $(x, y) \in A$ then $(x, f(x)) \in A$. The Axiom of Choice implies that for every set $A \subseteq \mathbb{R} \times \mathbb{R}$ there exists a function which uniformizes A . But if A is projective the Axiom of Choice seems to offer little insight into whether there is a function f which uniformizes the set A and which is *also* projective (in the sense that the graph of f is a projective subset of $\mathbb{R} \times \mathbb{R}$).

The two questions of Luzin are the following but I have expanded the scope of the second question—this is the measure question—to include the property of Baire.

1. Suppose $A \subseteq \mathbb{R} \times \mathbb{R}$ is projective. Can A be uniformized by a projective function?
2. Suppose $A \subseteq \mathbb{R}$ is projective. Is A Lebesgue measurable and does A have the property of Baire?

Luzin conjectured that “we will never know the answer to the measure question for the projective sets”. Luzin’s reason for such a bold conjecture is the obvious fact that Lebesgue measurability is not preserved under continuous images since any set $A \subseteq \mathbb{R}$ is the continuous image of a Lebesgue null set.

The exact mathematical constructions of Gödel [6], [7] and Cohen [1],[2] which were used to show that the Continuum Hypothesis can neither be proved nor refuted on the basis of the ZFC axioms, show that the uniformization question for the projective sets can also neither be proved or refuted from the axioms ZFC.

The measure question is more subtle but the construction of Gödel and a refinement of Cohen’s construction due to Solovay [25] show the same is true for the measure question. A curious wrinkle is that for Solovay’s construction a modest large cardinal hypothesis is necessary.

The structure of the projective sets is of fundamental mathematical interest since it is simply the structure of the standard model of Second Order Number Theory:

$$\langle \mathcal{P}(\mathbb{N}), \mathbb{N}, +, \cdot, \in \rangle.$$

3. Logical Definability from Parameters, Elementary Embeddings, and Ultrapowers

The answers to Luzin's questions involve aspects of Mathematical Logic and Set Theory which were unknown and unimagined at the time and I briefly review the basic context.

A set X is *transitive* if every element of X is a subset of X . Naively transitive sets can be viewed as *initial segments* of the Universe of Sets. The *ordinals* are the transitive sets α which are totally ordered by the set membership relation. There is a least infinite ordinal, denoted ω , and ω is simply the set of all finite ordinals. The order (ω, \in) is isomorphic to $(\mathbb{N}, <)$ and this also uniquely specifies ω as an ordinal. The ordinals provide the basis for *transfinite* constructions and in this sense they yield a generalization of the natural numbers into the infinite.

Formal notions of mathematical logic play a central role in Set Theory. Suppose X is a transitive set. Then a subset $Y \subseteq X$ is *logically definable* in (X, \in) from parameters if there exist elements a_1, \dots, a_n of X and a logical formula $\phi(x_0, \dots, x_n)$ in the formal language for Set Theory such that

$$Y = \{a \in X \mid (X, \in) \models \phi[a, a_1, \dots, a_n]\}.$$

Let's look at two examples. If $X = \omega$ then a subset $Y \subseteq X$ is logically definable in (X, \in) from parameters if and only if Y is finite or the complement of Y is finite. If X is the smallest transitive set which contains \mathbb{R} then the projective sets $A \subseteq \mathbb{R}$ are exactly those sets $A \subseteq \mathbb{R}$ which are logically definable from parameters in X . In general if X is a finite transitive set then every subset of X is logically definable in (X, \in) . Assuming the Axiom of Choice, if X is an infinite transitive set then there must exist subsets of X which are not logically definable in (X, \in) from parameters. The collection of *all* subsets of X is the *powerset* of X and is denoted by $\mathcal{P}(X)$.

Suppose X and Y are transitive sets. A function $\pi : X \rightarrow Y$ is an *elementary embedding* if for all formulas $\phi[x_0, \dots, x_n]$ in the formal language for Set Theory and all a_0, \dots, a_n in X ,

$$(X, \in) \models \phi[a_0, \dots, a_n] \text{ iff } (Y, \in) \models \phi[\pi(a_0), \dots, \pi(a_n)].$$

Note for example that if X is an ordinal and $\pi : X \rightarrow Y$ is an elementary embedding then Y must be an ordinal as well. In general elementary embeddings are simply functions which preserve logical truth (and so generalize the notion of isomorphism) and this makes sense for all mathematical structures (of the same logical type) not just the structures given by transitive sets which I am discussing here. However the case of transitive sets is quite special, if $\pi : X \rightarrow Y$ is both an elementary embedding and a surjection then π is the identity function.

Suppose X is a transitive set and U is a free ultrafilter over some index set I . Then one can form the ultrapower, X^I/U , to both define a new structure from X and an elementary embedding from X to this new structure—the points of X^I/U are equivalence classes $[f]_U$ of functions $f : I \rightarrow X$

where $f \sim g$ if $\{a \in I \mid f(a) = g(a)\} \in U$ and one defines $[f]_U \in_U [g]_U$ if $\{a \in I \mid f(a) \in g(a)\} \in U$. The elementary embedding sends a to $[f_a]_U$ where f_a is the constant function with value a .

For example, if $X = \omega$ then the ultrapower X^I/U is linear order. In general unless X is finite, the ultrapower X^I/U is not isomorphic to a transitive set. If however the ultrafilter U is closed under countable intersections then for each transitive set X , the ultrapower X^I/U is isomorphic to a transitive set Y and both Y and the isomorphism are unique. I note that in this situation, if the ultrapower is nontrivial (for example, if the ultrapower X^I/U is not isomorphic to X), then the set X must be very *large*. This is because if U is closed under countable intersections then U must be closed under intersections of cardinality δ for relatively large δ . This is the entry point for new notions of mathematical infinity which transcend the usual classical notions of infinity. It is such notions of infinity—completely unknown at the time of Luzin’s questions and directly the result of the influence of mathematical logic within Set Theory—which are the key to resolving Luzin’s questions. But surprisingly the explanation begins with yet another notion within Set Theory and this notion has nothing a priori to do with such (or any) strong axioms of infinity.

4. The Hierarchy of Large Cardinals, Determinacy, and the Answers to Luzin’s Questions

Suppose $A \subseteq \mathbb{R}$. There is an associated infinite game involving two players. The players alternate choosing $\epsilon_i \in \{0, 1\}$. After infinitely many moves an infinite binary sequence $\langle \epsilon_i : i \in \mathbb{N} \rangle$ is defined. Player I wins this run of the game if

$$\sum_{i=1}^{\infty} \epsilon_i / 2^i \in A$$

otherwise Player II wins. Either player could choose to follow a *strategy* which is simply a function

$$\tau : \text{SEQ} \rightarrow \{0, 1\}$$

where SEQ is the set of all finite binary sequences $\langle \epsilon_1, \dots, \epsilon_n \rangle$. The strategy τ is a winning strategy for that player if by following τ , that player wins no matter how the other player moves. Trivially if $[0, 1] \subseteq A$ then every strategy is a winning strategy for Player I and if $A \cap [0, 1] = \emptyset$ then every strategy is a winning strategy for Player II. The set A is *determined* if there is a winning strategy for one of the players in the game associated to A .

Gale and Stewart [5] proved that if A is a closed set then A is determined and they asked whether this is also true when A is borel. Mycielski and Steinhaus [20] took a much bolder step and formulated 50 years ago the axiom AD.

Definition 1 (Mycielski, Steinhaus). *Axiom of Determinacy* (AD): Every set $A \subseteq \mathbb{R}$ is determined. \square

The axiom AD is refuted by the Axiom of Choice and so it is false. But restricted versions have proven to be quite important and provide the answers (yes) to Luzin's questions, [18], [19], and [20].

Definition 2. *Projective Determinacy* (PD): Every projective set $A \subseteq \mathbb{R}$ is determined. \square

Theorem 3. *Assume every projective set is determined.*

- (1) (Mycielski, Steinhaus) *Every projective set has the property of Baire.*
- (2) (Mycielski, Swierczkowski) *Every projective set is Lebesgue measurable.*
- (3) (Moschovakis) *Every projective set $A \subseteq \mathbb{R} \times \mathbb{R}$ can be uniformized by a projective function.* \square

The axiom PD yields a rich structure theory for the projective sets and modulo notions of infinity no question about the projective sets is known to be unsolvable on the basis of ZFC + PD. But is PD even consistent and if consistent is PD true? The answers to both questions is yes but this involves another family of axioms, these are *large cardinal axioms* which are axioms of strong infinity. The basic modern form of these axioms is as follows where a class M is transitive if each element of M is a subset of M (just as for transitive sets). A cardinal κ is a *large cardinal* if there exists an elementary embedding,

$$j : V \rightarrow M$$

such that M is a transitive class and κ is the least cardinal such that $j(\alpha) \neq \alpha$. This is the *critical point* of j , denoted $\text{CRT}(j)$. By requiring more sets to belong to M , possibly in a way that depends on action of j on the cardinals, one obtains a hierarchy of notions. The obvious maximum here, taking $M = V$, is not possible (it is refuted by the Axiom of Choice by a theorem of Kunen). In some cases the large cardinal axiom of interest holding at κ is specified by the existence of many elementary embeddings and possibly elementary embeddings with smaller critical points than the cardinal κ .

The careful reader might object to the reference to classes but in all instances of interest one can require M and j be definable classes (from parameters but in a simple manner) and j need only be elementary with respect to rather simple formulas. The situation is analogous to that in Number Theory where one frequently refers to infinite collections such as the set of prime numbers. This does not require that one work in a theory of infinite sets—similarly the reference to j and M here in all the relevant instances does not require in general that one work in a theory of classes.

In this scheme the simplest large cardinal notion is that of a *measurable cardinal*. A cardinal κ is measurable if there exists an elementary embedding $j : V \rightarrow M$ such that $\kappa = \text{CRT}(j)$. This is not the usual definition (rather it is a theorem) but it is equivalent. The standard definition is that an uncountable

cardinal κ is a measurable cardinal if there exists an ultrafilter μ on κ (more precisely on the complete boolean algebra given by $\mathcal{P}(\kappa)$) which is nonprincipal (i.e., free) and which is closed under intersections of cardinality δ for all $\delta < \kappa$. Given μ one can form the ultrapower of the universe of sets, V^κ/μ , show that this ultrapower is isomorphic to a transitive class, and so generates an elementary embedding as above. Conversely given an elementary embedding j with $\text{CRT}(j) = \kappa$, define $\mu = \{A \subseteq \kappa \mid \kappa \in j(A)\}$. It follows that μ is a nonprincipal ultrafilter on κ which is closed under intersections of cardinality δ for all $\delta < \kappa$.

Beside measurable cardinals, there are *strong cardinals*, *Woodin cardinals*, *superstrong cardinals*, *supercompact cardinals*, *extendible cardinals*, *huge cardinals*, and much more. These I shall not define with exception of supercompact and extendible cardinals but I shall defer these particular definitions until Section 10. I refer the reader to the excellent exposition [10] for details and the history of the development of large cardinal axioms. I also note that all these large cardinal notions have equivalent reformulations in terms of ultrapowers or direct limits of ultrapowers.

The connection between Projective Determinacy and large cardinal axioms is given in the next two theorems the first of which is the seminal theorem of Martin and Steel [15]. These theorems proved in 1985 and 1987, respectively, brought to a close a chapter which began over 60 years earlier with the questions of Luzin. But as I hope to show in a convincing fashion, the real story was just beginning.

Theorem 4 (Martin, Steel). *Assume there are infinitely many Woodin cardinals. Then every projective set is determined.* \square

Theorem 5 (Woodin). *The following are equivalent.*

- (1) *Every projective set is determined.*
- (2) *For each $n < \omega$ there is a countable (iterable) model M such that*

$$M \models \text{ZFC} + \text{“There exist at least } n \text{ Woodin cardinals”}. \quad \square$$

With these theorems one can assert that PD is both consistent and true and this represents a mathematical milestone since we now have the axioms for the structure,

$$\langle \mathcal{P}(\mathbb{N}), \mathbb{N}, +, \cdot, \in \rangle,$$

which are the correct extension of the Peano axioms for the structure $\langle \mathbb{N}, +, \cdot \rangle$.

Can this success be extended to the entire universe of sets?

5. Rank-universal Sentences and the Cumulative Hierarchy

The cumulative hierarchy stratifies the universe of sets. The definition involves transfinite iterations of the operation of taking powersets. Recall that for each

set X , the powerset of X , denoted $\mathcal{P}(X)$, is the set of all subsets of X . Now define by induction on the ordinal α a set V_α as follows.

1. $V_0 = \emptyset$.
2. (Successor step) $V_{\alpha+1} = \mathcal{P}(V_\alpha)$.
3. (Limit step) $V_\alpha = \cup\{V_\beta \mid \beta < \alpha\}$.

It is a consequence of the axioms ZFC that for each ordinal α , V_α exists and moreover that for each set X there exists an ordinal α such that $X \in V_\alpha$. The set V_α is the *rank initial segment* of V determined by the ordinal α . This calibration of V suggests that to understand V one should simply proceed by induction on α , analyzing V_α .

The integers appear in V_ω , the reals appear in $V_{\omega+1}$, and all sets of reals appear in $V_{\omega+2}$. The projective sets in their incarnation as relations of Second Order Number Theory appear in effect in $V_{\omega+1}$ since $V_{\omega+1}$ is logically bi-interpretable with $\langle \mathcal{P}(\mathbb{N}), \mathbb{N}, +, \cdot, \in \rangle$. Given the amount of mathematical effort and development which was required to understand $V_{\omega+1}$ just to the point where one could identify the correct axioms for $V_{\omega+1}$, and noting that this is an infinitesimal fragment of the Universe of Sets, the prospects for understanding V to this same degree, or even just $V_{\omega+2}$ which would reveal whether the Continuum Hypothesis is true, is a daunting task.

I take a strong, perhaps unreasonable position, on this. The statement that Projective Determinacy is consistent is a new mathematical truth. It predicts facts about our world, for example that in the next 1000 years, so by ICM 3010, there will be no contradiction discovered from Projective Determinacy *by any means*. Of course one could respond with the observation that with each new theorem of mathematics comes such a prediction. For example from Wiles' proof of Fermat's Last Theorem, one has the superficially similar prediction that no counterexample to FLT will be discovered. But this prediction, while certainly a new prediction, is reducible by finite means (i.e. the proof) to a previous prediction—namely that the axioms (whatever they are) necessary for Wiles' proof will not be discovered to be contradictory. This is *not* the case for the prediction I have made above. That prediction is a genuinely new prediction which is not reducible by finite means to any previously held prediction (say from before 1960). This is the nature of the investigation of large cardinal axioms which sets it apart from other mathematical enterprises. But now there is a dilemma. The claim that a large cardinal axiom is consistent, such as the claim that the existence of Woodin cardinals is consistent, would seem ultimately to have to be founded on a conception of truth for the Universe of Sets which includes the existence of these large cardinals. But if our axioms for this Universe of Sets fail to resolve even the most basic questions about the Universe of Sets, such as that of the Continuum Hypothesis, then ultimately what sense is there to the claim that large cardinals exist? This is perhaps tolerable on a temporary basis during a period of axiomatic discovery but it certainly cannot be the permanent state of affairs.

The alternative position—that consistency claims can never be meaningfully made—is simply a rejection of the infinite altogether. And what if my prediction is correct and an instance of an evolving series of ever stronger similarly correct predictions? How will this skeptic explain that?

In any case an incremental approach might be prudent and so I shall restrict attention to sentences about the universe of sets of a particular form. A sentence ϕ is a *rank-universal* sentence if for some sentence ψ , ϕ asserts that

$$V_\alpha \models \psi$$

for all ordinals α . Similarly a sentence ϕ is a *rank-existential* sentence if for some sentence ψ , ϕ asserts that there exists an ordinal α such that $V_\alpha \models \psi$.

For any sentence ψ , the assertion that

$$V_{\omega+2} \models \psi$$

is both rank-universal and rank-existential and so the Continuum Hypothesis is expressible as both a rank universal sentence and a rank existential sentence. There is nothing particularly special about the ordinal ω here or for that matter about 2 either. For example if δ_0 is the least Woodin cardinal then for any sentence ψ , the assertion that

$$V_{\delta_0+\omega} \models \psi$$

is both rank-universal and rank-existential, etc.

6. The Effective Cumulative Hierarchy: L

Gödel's definition of L arises from restricting the successor step in the definition of the cumulative hierarchy. For each set X , let $\mathcal{P}_{\text{Def}}(X)$ be the set of all $Y \subseteq X$ such that Y is logically definable in the structure (X, \in) from parameters in X . If X is infinite and the Axiom of Choice holds then $\mathcal{P}_{\text{Def}}(X)$ is never the set of all subsets of X . Now define L_α by induction on α as follows.

1. $L_0 = \emptyset$,
2. (Successor case) $L_{\alpha+1} = \mathcal{P}_{\text{Def}}(L_\alpha)$,
3. (Limit case) $L_\alpha = \cup\{L_\beta \mid \beta < \alpha\}$.

Definition 6. L is the class of all sets X such that $X \in L_\alpha$ for some ordinal α . □

The axiom " $V = L$ " is Gödel's Axiom of Constructibility and this axiom is expressible by a rank-universal sentence.

Theorem 7. *Assume $V = L$.*

- (1) (Gödel) *Every projective set $A \subseteq \mathbb{R} \times \mathbb{R}$ can be uniformized by a projective function.*

- (2) (Gödel) *There is a projective set which is not Lebesgue measurable (there is a projective wellordering of the reals).*
- (3) (Scott) *There are no measurable cardinals.* \square

Scott's Theorem was proved just before the seminal work of Cohen and so provided the first consistency proof that $V \neq L$. My own view is more extreme on the significance of Scott's Theorem:

Corollary 8. $V \neq L$. \square

It is Scott's Theorem which shows that to find canonical models in which large cardinal axioms hold one must somehow enlarge L . This is the Inner Model Program.

7. $L(\mathbb{R})$ and AD

By *relativizing* L to \mathbb{R} one obtains $L(\mathbb{R})$ which provides a transfinite extension of the projective sets. The formal definition proceeds by first defining $L_\alpha(\mathbb{R})$ by induction on α :

1. $L_0(\mathbb{R}) = \mathbb{R}$ (more precisely $L_0(\mathbb{R}) = V_{\omega+1}$),
2. (Successor case) $L_{\alpha+1}(\mathbb{R}) = \mathcal{P}_{\text{Def}}(L_\alpha(\mathbb{R}))$,
3. (Limit case) $L_\alpha(\mathbb{R}) = \cup\{L_\beta(\mathbb{R}) \mid \beta < \alpha\}$.

Definition 9. $L(\mathbb{R})$ is the class of all sets X such that $X \in L_\alpha(\mathbb{R})$ for some ordinal α . \square

The projective sets are precisely the sets in

$$L_1(\mathbb{R}) \cap \mathcal{P}(\mathbb{R})$$

and

$$L_{\omega_1}(\mathbb{R}) \cap \mathcal{P}(\mathbb{R})$$

is the smallest σ -algebra containing the projective sets and closed under images by continuous functions, $f : \mathbb{R} \rightarrow \mathbb{R}$. The collection $\mathcal{P}(\mathbb{R}) \cap L(\mathbb{R})$ is a transfinite extension of the projective sets.

A natural axiom generalizing the axiom that all projective sets are determined is the axiom, " $L(\mathbb{R}) \models \text{AD}$ ", which is simply the axiom which asserts that every set $A \in L(\mathbb{R}) \cap \mathcal{P}(\mathbb{R})$ is determined.

Theorem 10 (Martin, Steel, Woodin). *Assume there are infinitely many Woodin cardinals with a measurable cardinal above. Then $L(\mathbb{R}) \models \text{AD}$.* \square

The proof of the theorem involves combining [15] with methods from previous results and something like the measurable cardinal is necessary but only just barely. The following theorem clarifies the situation by providing an exact match to the axiom “ $L(\mathbb{R}) \models \text{AD}$ ” within the hierarchy of large cardinals axioms and from the perspective of the formal consistency of theories.

Theorem 11 (Woodin). *The following theories are equiconsistent.*

- (1) $\text{ZFC} + “L(\mathbb{R}) \models \text{AD}”$.
- (2) $\text{ZFC} + “\text{There are infinitely many Woodin cardinals}”$. □

The axiom, $L(\mathbb{R}) \models \text{AD}$, gives a complete analysis of $L(\mathbb{R})$ extending the analysis that the axiom, all projective sets are determined, provides for the projective sets. For example Moschovakis’s theorem on uniformization generalizes to show that for many ordinals α , assuming all sets in $L_\alpha(\mathbb{R}) \cap \mathcal{P}(\mathbb{R})$ are determined, uniformization holds in $L_\alpha(\mathbb{R})$. This includes all countable α and quite a bit more. Subsequent work of Steel has exactly characterized these ordinals.

Of course assuming $V = L$, uniformization holds in $L(\mathbb{R})$ since in this case $L(\mathbb{R}) = L$. But if uniformization holds in $L(\mathbb{R})$ then the Axiom of Choice *must* hold in $L(\mathbb{R})$ and so in $L(\mathbb{R})$, uniformization implies that $L(\mathbb{R}) \not\models \text{AD}$. Thus there is mathematical tension between uniformization and the regularity properties such as Lebesgue measurability and having the property of Baire.

Theorem 12 (Woodin). *Suppose that uniformization holds in $L_\alpha(\mathbb{R})$ and that $\alpha = \omega_1 \cdot \beta$ for some limit ordinal β . Then the following are equivalent.*

- (1) *Every set $A \in L_\alpha(\mathbb{R}) \cap \mathcal{P}(\mathbb{R})$ is Lebesgue measurable and has the property of Baire.*
- (2) *Every set $A \in L_\alpha(\mathbb{R}) \cap \mathcal{P}(\mathbb{R})$ is determined.* □

The proof of the theorem uses rather elaborate machinery to construct given $A \in L_\alpha(\mathbb{R}) \cap \mathcal{P}(\mathbb{R})$ and assuming (1), a countable transitive set M such that $A \cap M \in M$ and such that in M there are Woodin cardinals sufficient to establish that $A \cap M$ is determined. There is an additional requirement that $M \cap A$ be correct about whether a strategy is a winning strategy in the game associated to A and so the determinacy of $A \cap M$ within M yields the determinacy of A .

By a remarkable theorem of Steel the restriction on α is *necessary*, in particular Theorem 12 does not hold with $\alpha = \omega_1$ and this fact argues strongly that there is no elementary proof of the theorem even in specific cases such as $\alpha = \omega_1 \cdot \omega_1$ where the theorem does hold.

The previous theorem is now one of many analogous theorems which have been proved, including recent dramatic results of Sargsyan [21]. These theorems collectively confirm that the understanding of determinacy plays a central role in modern Set Theory. The ubiquity of Projective Determinacy in infinitary combinatorics is often cited as an independent confirmation of its truth.

8. The Universally Baire Sets

For any set E there is an associated enlargement of L , denoted $L[E]$, which is defined as follows. For each ordinal α , $L_\alpha[E]$ is first defined by induction on α :

1. $L_0[E] = \emptyset$
2. (Successor case) $L_{\alpha+1}[E] = \mathcal{P}_{\text{Def}}(L_\alpha[E] \cup \{E \cap L_\alpha[E]\})$,
3. (Limit case) $L_\alpha[E] = \cup\{L_\beta[E] \mid \beta < \alpha\}$.

Then $L[E]$ is defined as the class of all sets X such that $X \in L_\alpha[E]$ for some ordinal α . One can also in analogous fashion modify the definition of $L(\mathbb{R})$ to define $L(\mathbb{R})[E]$. I caution that $L[\mathbb{R}] = L$ and so in general $L(\mathbb{R}) \neq L[\mathbb{R}]$.

Assuming the Axiom of Choice for *any* set X there exists a set E such that $X \in L[E]$ (this is equivalent to the Axiom of Choice). So for the Inner Model Program where one seeks structural generalizations of L one must somehow restrict the choices of E .

For the case of measurable cardinals there is an elegant solution to the choice of E . Suppose that κ is a measurable cardinal and let

$$j : V \rightarrow M$$

be an associated elementary embedding with $\text{CRT}(j) = \kappa$. Define an ultrafilter μ on κ by $A \in \mu$ if $\kappa \in j(A)$. Then μ is a nonprincipal ultrafilter on κ closed under intersections of cardinality δ for all $\delta < \kappa$. The enlargement of L given by $L[\mu]$ turns out to be a true generalization of L .

Theorem 13 (Kunen). *Suppose κ is a measurable cardinal with associated ultrafilter μ .*

- (1) $L[\mu]$ and $\mu \cap L[\mu]$ each depend only on κ .
- (2) $L[\mu] \cap \mathbb{R}$ is independent of both κ and μ .
- (3) $L[\mu] \models$ “ κ is the only measurable cardinal”. □

Theorem 14 (Silver). *Suppose κ is a measurable cardinal with associated ultrafilter μ . Then*

$$L[\mu] \models \text{“There is a projective wellordering of the reals”}. \quad \square$$

One can also consider $L(\mathbb{R})[\mu]$, the associated enlargement of $L(\mathbb{R})$.

Theorem 15. *Suppose κ is a measurable cardinal with associated ultrafilter μ .*

- (1) (Kunen) $L(\mathbb{R})[\mu] \cap \mathcal{P}(\mathbb{R})$ is independent of both κ and μ .
- (2) (Woodin) *Suppose there are infinitely many Woodin cardinals with at least two measurable cardinals above. Then $L(\mathbb{R})[\mu] \models \text{AD}$.* □

In general the enlargements of L produced by the Inner Model Program have companion enlargements of $L(\mathbb{R})$. If we cannot yet define an ultimate inner model perhaps we can nevertheless define the ultimate extension of $\mathcal{P}(\mathbb{R}) \cap L(\mathbb{R})$. It turns out that assuming there is a proper class of Woodin cardinals, we can. Even more we can define the order in which these sets of reals are generated by that ultimate enlargement of L adapted to produce an enlargement of $L(\mathbb{R})$. The following definition is from [4].

Definition 16. A set $A \subseteq \mathbb{R}$ is *universally Baire* if for all topological spaces Ω and for all continuous functions $\pi : \Omega \rightarrow \mathbb{R}$, the preimage of A by π has the property of Baire in the space Ω . \square

One can restrict to only those spaces Ω which are compact Hausdorff spaces and obtain an equivalent definition. The definition that a set $A \subseteq \mathbb{R} \times \mathbb{R}$ is universally Baire is identical. A partial function $f : \mathbb{R} \rightarrow \mathbb{R}$ is universally Baire if its graph is universally Baire. Given $A \subseteq \mathbb{R}$ one defines $L(A, \mathbb{R})$ following the definition of $L(\mathbb{R})$ except $L_0(A, \mathbb{R}) = L_0(\mathbb{R}) \cup \{A\}$.

Theorem 17. *Suppose that there is a proper class of Woodin cardinals.*

- (1) (Martin-Steel) *Suppose $A \subseteq \mathbb{R}$ is universally Baire. Then A is determined.*
- (2) (Woodin) *Suppose $A \subseteq \mathbb{R}$ is universally Baire. Then every set $B \in L(A, \mathbb{R}) \cap \mathcal{P}(\mathbb{R})$ is universally Baire.*
- (3) (Steel) *Suppose $A \subseteq \mathbb{R} \times \mathbb{R}$ is universally Baire. Then A can be uniformized by a universally Baire function.* \square

There is an ordinal measure of complexity for the universally Baire sets—this can be defined a number of ways and I define a somewhat coarse notion using a definition which is just for this account. Suppose A and B are subsets of \mathbb{R} . Define A to be *borel reducible* to B , written $A \leq_{\text{borel}} B$, if there is a borel function $\pi : \mathbb{R} \rightarrow \mathbb{R}$ such that either $A = \pi^{-1}[B]$ or $A = \mathbb{R} \setminus \pi^{-1}[B]$. Define $A <_{\text{borel}} B$ if $A \leq_{\text{borel}} B$ but $B \not\leq_{\text{borel}} A$. Finally define A and B to be *borel bi-reducible* if both $A \leq_{\text{borel}} B$ and $B \leq_{\text{borel}} A$. The *borel degree* of A is the equivalence class of all sets which are borel bi-reducible with A . The borel degree of a set $A \subseteq \mathbb{R}$ is analogous to the Turing degree of a set $A \subseteq \mathbb{N}$.

The following lemma is an immediate corollary of the rather remarkable Wadge's Lemma from the theory of determinacy together with the determinacy of the universally Baire sets. The subsequent theorem is similarly a corollary of a fundamental theorem of Martin on the Wadge order.

Lemma 18. *Assume there is a proper class of Woodin cardinals. Suppose that A and B are universally Baire subsets of \mathbb{R} .*

- (1) *Either $A \leq_{\text{borel}} B$ or $B \leq_{\text{borel}} A$,*
- (2) *Suppose $A <_{\text{borel}} B$. Then there is a borel function $\pi : \mathbb{R} \rightarrow \mathbb{R}$ such that $A = \pi^{-1}[B]$.* \square

Theorem 19. *Assume there is a proper class of Woodin cardinals. There is no sequence $\langle A_i : i < \omega \rangle$ of universally Baire sets such that for all $i < \omega$, $A_{i+1} <_{\text{borel}} A_i$. \square*

Thus, assuming there is a proper class of Woodin cardinals, the borel degrees of the universally Baire sets are linearly ordered by borel reducibility and moreover this linear order is a wellorder.

I illustrate the relevance of this to the Inner Model Program. Suppose that there is proper class of Woodin cardinals and consider the enlargement of $L(\mathbb{R})$ given by $L(\mathbb{R})[\mu]$ as discussed above. Then the sets in $L(\mathbb{R})[\mu] \cap \mathcal{P}(\mathbb{R})$ are all universally Baire. Suppose that $A, B \in L(\mathbb{R})[\mu] \cap \mathcal{P}(\mathbb{R})$ and that for some ordinal α , $A \in L_\alpha(\mathbb{R})[\mu]$ but $B \notin L_\alpha(\mathbb{R})[\mu]$. Then $A <_{\text{borel}} B$.

In general, the ranking of the universally Baire sets given by borel reducibility must *refine* the order of generation of these sets in any possible enlargement of L adapted to define an enlargement of $L(\mathbb{R})$. The point here is that for any transitive set X , if $A \leq_{\text{borel}} B$ and $B \in \mathcal{P}_{\text{Def}}(X)$ then $A \in \mathcal{P}_{\text{Def}}(X)$.

In summary, the sets generated by any possible enlargement of L (subject only to very general constraints) adapted to define an enlargement of $L(\mathbb{R})$ defines an initial segment of the universally Baire sets relative to the order of borel reducibility. The extent of that initial segment is determined by the extent of the large cardinal axioms which hold in the initial segments of that enlargement.

9. Ω -logic and the Ω Conjecture

The foundational issues of truth in Set Theory arise because of Cohen's method of forcing and I shall refer in this paper to extensions obtained by the method of forcing as *Cohen extensions*. Cohen extensions are the source of the profound unsolvability of problems such as that of the Continuum Hypothesis which makes these problems seem so intractable. This is in contrast to Luzin's questions about the projective sets which we have seen are resolved by simply invoking strong notions of infinity. Perhaps then the best one can do is a multiverse conception of the universe of sets. To illustrate suppose that M is a countable (transitive) model of ZFC (of course one cannot prove such a set exists without appealing to large cardinal axioms). Let $\mathbb{V}(M)$ be the smallest collection of countable transitive models such that if (M_0, M_1) is any pair of countable transitive models with M_1 a Cohen extension of M_0 , if either $M_0 \in \mathbb{V}(M)$ or $M_1 \in \mathbb{V}(M)$ then both models are in $\mathbb{V}(M)$. $\mathbb{V}(M)$ is the *generic multiverse* generated by M . Taking M to be V itself, this defines the generic-multiverse.

Of course one is interested in the corresponding notion of truth. So a sentence ϕ is *true* in the generic-multiverse generated by V if ϕ is true in *each* universe of the generic-multiverse generated by V . This can be made perfectly precise (without quantifying over classes) and I shall give a relatively simple reformulation at least for rank-universal sentences. It turns out that for essentially

all large cardinal axioms (and certainly all listed in this account), the existence of a proper class of κ witnessing the large cardinal axiom, is *invariant* across the generic-multiverse generated by V . For example the existence of a proper class of Woodin cardinals if true in *one* universe of the generic-multiverse generated by V , is true in *every* universe of the generic-multiverse generated by V [8]. Thus a generic-multiverse conception of the universe of sets could provide a framework for set theoretic truth which allows one to confirm the consistency of large cardinal axioms, even confirm that Projective Determinacy is true, and yet not resolve questions such as that of the Continuum Hypothesis. But only if such a conception of truth is compatible with the basic principles of infinity on which ZFC is founded.

There is a remarkable consequence of large cardinal axioms which gives a very simple equivalent definition (modulo the definition of Cohen's method of forcing) that a rank-universal sentence is true in the generic-multiverse generated by V .

Theorem 20. *Suppose that there is a proper class of Woodin cardinals and that ϕ is a rank-universal sentence. Then the following are equivalent.*

- (1) ϕ is true in the generic-multiverse generated by V .
- (2) ϕ is true in all Cohen extensions of V . □

To say that a rank-universal sentence is true in all Cohen extensions of V is itself a rank-universal sentence. So this theorem shows that in the context of a proper class of Woodin cardinals, the assertion that a rank-universal sentence is true in the generic-multiverse generated by V is itself a rank-universal sentence. I note that without the indicated large cardinal hypothesis, the previous theorem is *false*. For example the conclusion of the theorem is false if V is a Cohen extension of L and $\mathbb{R} \not\subseteq L$.

The generic-multiverse conception of truth is connected by the previous theorem to Ω -logic.

Definition 21. Suppose ϕ is a rank-universal sentence. Then ϕ is Ω -*valid*, written $\models_{\Omega} \phi$, if ϕ is true in all Cohen extensions of V . □

Is there a notion of proof for Ω -logic? This leads back to the universally Baire sets.

Definition 22. Suppose $A \subseteq \mathbb{R}$ is universally Baire and M is a countable transitive model of ZFC. Then M is *strongly A -closed* if $A \cap N \in N$ for all countable transitive sets N such that N is a Cohen extension of M . □

Definition 23. Assume there is a proper class of Woodin cardinals. Suppose ϕ is a rank-universal sentence. Then ϕ is Ω -*provable*, written $\vdash_{\Omega} \phi$, if there is a universally Baire set $A \subseteq \mathbb{R}$ such that if M is a countable transitive model of ZFC and M is strongly A -closed then $M \models \text{"}\models_{\Omega} \phi\text{"}$, or equivalently $N \models \phi$ for all countable transitive sets N such that N is a Cohen extension of M . □

The ordinal rank of complexity that I defined for universally Baire sets provides a very reasonable notion of length of proof and so Ω -logic shares many features with classical logic.

I now come to the Ω Conjecture and the issue is whether Ω -validity implies Ω -provability.

Definition 24 (The Ω Conjecture). Assume there is a proper class of Woodin cardinals and ϕ is a rank-universal sentence. Then ϕ is Ω -valid if and only if ϕ is Ω -provable. \square

How does the Ω Conjecture impact the generic-multiverse conception of truth? There are two relevant theorems. The point is that for rank-universal sentences, truth in the generic-multiverse is equivalent to Ω -validity and so to Ω -provability if the Ω Conjecture holds (nontrivially).

Theorem 25. *Suppose that there is a proper class of Woodin cardinals and let δ_0 be the least Woodin cardinal. Assume the Ω Conjecture holds. Then the set of rank-universal sentences which are Ω -valid is definable in V_{δ_0+1} .* \square

Let T_0 be the set of sentences ψ such that “ $V_{\omega+2} \models \psi$ ” is a generic-multiverse truth and let T be the set of *all* rank-universal sentences which are generic-multiverse truths. Clearly T_0 is reducible to T . The second theorem shows that assuming the Ω Conjecture (and that there is a proper class of Woodin cardinals) then these two sets have the same computational complexity by showing that T is reducible to T_0 (and the proof gives the explicit reduction).

Theorem 26. *Suppose that there is a proper class of Woodin cardinals and assume the Ω Conjecture holds. Then T is recursively reducible to T_0 .* \square

Why is this a problem? Assuming the Ω Conjecture (and that there is a proper class of Woodin cardinals), then the second theorem shows that the whole hierarchy of rank-universal truth—in the generic-multiverse conception of truth—collapses to simply the truths of $V_{\omega+2}$. Moreover augmented by a second conjecture, the Ω Conjecture yields a strong form of the first theorem—namely that this set of sentences is actually definable in $V_{\omega+2}$.

This collapse is completely counter to the fundamental principles concerning infinity on which Set Theory is founded. Moreover since $V_{\omega+2}$ is in essence just the standard structure for Third Order Number Theory, this collapse shows that the generic-multiverse conception of truth (for rank-universal sentences) is simply a version of third order formalism. If the Ω Conjecture is true then the generic-multiverse conception of truth is untenable.

No viable alternative multiverse conception of truth is known that survives the challenge posed by the Ω Conjecture and this seems to argue for a multiverse of one universe which leads us back to searching for generalizations of the axiom $V = L$ and the Inner Model Program.

Perhaps this all is simply evidence that the Ω Conjecture is false. The Ω Conjecture is invariant across the generic multiverse generated by V and so a reasonable conjecture is that if the Ω Conjecture can fail then it must be refuted by

some large cardinal axiom. But the Ω Conjecture *holds* in all the enlargements of L produced by the Inner Model Program and so to the extent this program succeeds in analyzing large cardinal axioms, *no large cardinal axiom can refute the Ω Conjecture*.

10. Extenders, Supercompact Cardinals, and HOD

It is Scott's theorem that if $V = L$ then there are no measurable cardinals which necessitates the search for generalizations of the definition of L in which large cardinal axioms can hold. This is reinforced by Gödel's theorem that shows that if $V = L$ then one cannot have the true theory of the projective sets: projective determinacy must fail and moreover there are pathological projective sets.

But how should one enlarge L ? The enlargements are of the form $L[\mathbb{E}]$ for some set (or class) \mathbb{E} . The problem is to identify sets \mathbb{E} for which $L[\mathbb{E}]$ is a generalization of L from the perspective of definability. Since the issue is large cardinal axioms, these sets should somehow be derived from large cardinals. The relevant key notion is that of an *extender*, the modern formulation is due to Jensen and based on an earlier formulation due to Mitchell. There are precursors due to Powell (in a model theoretic context) and to Jensen, see [10] for more details. To simplify this exposition I deviate from the standard definition of an extender and use a definition which is in some ways more restricted, in other ways more general, but in all ways less technical to state.

Definition 27. A function, $E : \mathcal{P}(\gamma) \rightarrow \mathcal{P}(\gamma)$ where γ is an ordinal, is an *extender* of length γ if there exists an elementary embedding $j : V \rightarrow M$ such that

1. $\text{CRT}(j) < \gamma$ and $V_{\gamma+\omega} \subseteq M$,
2. for all $A \subseteq \gamma$, $E(A) = j(A) \cap \gamma$. □

If E is an extender it is convenient to define $\text{CRT}(E) = \text{CRT}(j)$ where $j : V \rightarrow M$ witnesses that E is an extender. This is well-defined and $\text{CRT}(E)$ is easily computed from E itself.

Let's look at an example. Suppose $j : V \rightarrow M$ is an elementary embedding with $\text{CRT}(j) = \kappa$ and with $V_{\kappa+\omega} \subset M$. Recall that the associated ultrafilter μ on κ is defined by $A \in \mu$ if $\kappa \in j(A)$. Let

$$E : \mathcal{P}(\kappa + 1) \rightarrow \mathcal{P}(\kappa + 1)$$

be the associated extender of length $\kappa + 1$, this is the shortest possible extender defined from j . Then $L[E] = L[\mu]$. Unfortunately if $\kappa < \gamma \leq j(\kappa)$, $V_{\gamma+\omega} \subset M$, and if E is the associated extender of length γ , then nothing changes; $L[E]$ is closed under E and $L[E] = L[\mu]$. Therefore $L[E]$ where E is a single extender

is not a rich enough enlargement of L . For this reason (and others) one must use sequences of *fragments* of extenders to construct the inner models. All the information required is encoded into a set (or even possibly a class) $\mathbb{E} \subset \text{Ord}$ and the enlargement of L produced is the class $L[\mathbb{E}]$.

Definition 28. Suppose $\mathbb{E} \subset \text{Ord}$. Then $\mathcal{E}(L[\mathbb{E}]:V)$ denotes the class of all $F \cap L[\mathbb{E}]$ such that F is an extender, $F \cap L[\mathbb{E}] \in L[\mathbb{E}]$, and such that $F \cap L[\mathbb{E}]$ is an extender in $L[\mathbb{E}]$. \square

In general the difficulty in constructing \mathbb{E} is arranging that $\mathcal{E}(L[\mathbb{E}]:V)$ is rich enough to witness that the targeted large cardinal axiom holds within $L[\mathbb{E}]$ while simultaneously arranging that $L[\mathbb{E}]$ is canonical. It is the tension between these two goals which generates the difficulties. It is the richness of $\mathcal{E}(L[\mathbb{E}]:V)$ which calibrates where the enlargement of L given by $L[\mathbb{E}]$ sits in the hierarchy of all enlargements of L . I have not defined what it means for $L[\mathbb{E}]$ to be canonical but there is an easily stated variation of this requirement that modulo possibly passing to a Cohen extension of V can be imposed with no additional difficulty, it is the requirement that the sets in $\mathcal{P}(\mathbb{R}) \cap L(\mathbb{R})[\mathbb{E}]$ be universally Baire or even just that $L(\mathbb{R})[\mathbb{E}] \models \text{AD}$.

The critical large cardinal notion is due to Reinhardt and Solovay from nearly 40 years ago. The definition below is based on a reformulation due to Magidor.

Definition 29. A cardinal δ is a *supercompact cardinal* if for all $\gamma > \delta$ there exist $\bar{\gamma} < \delta$ and an elementary embedding $j : V_{\bar{\gamma}+1} \rightarrow V_{\gamma+1}$ such that $j(\bar{\delta}) = \delta$ where $\bar{\delta} = \text{CRT}(j)$. \square

This definition of a supercompact cardinal is closely related to the definition of an extendible cardinal which is due to Reinhardt and which is a much stronger large cardinal notion.

Definition 30. A cardinal δ is an *extendible cardinal* if for all $\gamma > \delta$ there exist $\bar{\gamma} > \delta$ and an elementary embedding $j : V_{\gamma+1} \rightarrow V_{\bar{\gamma}+1}$ such that $\text{CRT}(j) = \delta$ and $j(\delta) > \gamma$. \square

If E is an extender then E can be used to construct an elementary embedding $j_E : V \rightarrow M_E$ as a direct limit of elementary embeddings given by ultrapowers. If \mathcal{E} is a collection of extenders then \mathcal{E} *witnesses* that δ is a supercompact cardinal if the elementary embeddings $j_E|V_\alpha$ where $E \in \mathcal{E}$ suffice to witness the definition above that δ is supercompact. I can now state the recent theorems which show that by the level of exactly one supercompact cardinal something remarkable happens [29].

Theorem 31. Suppose $\mathbb{E} \subset \text{Ord}$, δ is supercompact in $L[\mathbb{E}]$ and this is witnessed in $L[\mathbb{E}]$ by $\mathcal{E}(L[\mathbb{E}]:V)$. Suppose F is an extender of strongly inaccessible length such that $L[\mathbb{E}]$ is closed under F and such that $\text{CRT}(F) \geq \delta$. Then $F \cap L[\mathbb{E}] \in L[\mathbb{E}]$. \square

I note that L is closed under *all* extenders and more generally if N is any transitive class which contains the ordinals and if sufficient large cardinals exist in V then necessarily N is closed under F for a rich class of extenders F of strongly inaccessible length. Therefore the requirements that $L[\mathbb{E}]$ be closed under F and F have strongly inaccessible length are not a very restrictive requirements.

To date the basic methodology of constructing inner models $L[\mathbb{E}]$ which generalize L is such that if F is an extender in $L[\mathbb{E}]$, then F is given by an initial segment of an extender specified explicitly by \mathbb{E} , [22]. Roughly, \mathbb{E} is constructed as a sequence of extender fragments and if F is an extender of $L[\mathbb{E}]$ then F is an initial segment of a fragment on the sequence \mathbb{E} . This has always seemed an essential feature of the detailed analysis of $L[\mathbb{E}]$ and it is closely related to why each new construction of $L[\mathbb{E}]$ has come with an associated generalization of Scott's Theorem (that there are no measurable cardinals in L). The previous theorem easily yields a complete reversal of this at the level of one supercompact cardinal. For example if $\kappa > \delta$ is an extendible cardinal then κ must be a supercompact cardinal in $L[\mathbb{E}]$ and this generalizes to essentially all large cardinal notions.

The next theorem—which is also closely related to the previous theorem—gives yet another measure of the transcendence of and possible construction of $L[\mathbb{E}]$ at the level of one supercompact cardinal. at least in a background universe of sufficient large cardinal strength, must correctly compute the proof relation for Ω -logic.

Theorem 32. *Suppose there is a proper class of extendible cardinals. Suppose $\mathbb{E} \subset \text{Ord}$, δ is supercompact in $L[\mathbb{E}]$ and this is witnessed in $L[\mathbb{E}]$ by $\mathcal{E}(L[\mathbb{E}]:V)$. Then for all rank-universal sentences ϕ the following are equivalent.*

- (1) $\vdash_{\Omega} \phi$.
- (2) $L[\mathbb{E}] \models \neg_{\Omega} \phi$. □

I require another definition due to Gödel. This definition is of the class HOD of all hereditarily ordinal definable sets and here I give an equivalent reformulation of Gödel's definition which highlights it as some sort of merge of the definitions of the cumulative hierarchy and that of L .

Definition 33. HOD is the class of all sets X such that there exist $\alpha \in \text{Ord}$ and $A \subseteq \alpha$ such that A is definable in V_{α} without parameters and such that $X \in L[A]$. □

If $V = L$ then $\text{HOD} = L$ but if for example $L(\mathbb{R}) \models \text{AD}$ then $\text{HOD} \neq L$. The class HOD is not in general canonical, for example by passing to a Cohen extension of V one can arrange that *any* designated set of V be an element of HOD as defined in the extension.

There is a remarkable theorem of Vopenka which connects HOD and Cohen's method of forcing, see [10]. This theorem illustrates why Cohen's method

is so central in Set Theory and for reasons other than simply establishing independence results. If $G \subset \text{Ord}$ then HOD_G is simply HOD defined allowing G as a parameter (so $G \in \text{HOD}_G$).

Theorem 34 (Vopenka). *For each set $G \subset \text{Ord}$, if $G \notin \text{HOD}$ then HOD_G is a Cohen extension of HOD .* \square

With these definitions I can pose two questions any positive solution to which will likely involve the successful extension of the Inner Model Program to the level of one supercompact cardinal—in the sense of producing (subject to the requirements of the program) $\mathbb{E} \subset \text{Ord}$ such that for some δ , δ is supercompact in $L[\mathbb{E}]$ and this is witnessed in $L[\mathbb{E}]$ by $\mathcal{E}(L[\mathbb{E}]:V)$. For the first question it is entirely possible that there be a positive solution obtained by other means but not (I believe) for the second question. The first question involves $\mathcal{E}(\text{HOD}:V)$ which is defined in the natural fashion: $\mathcal{E}(\text{HOD}:V)$ is the class of all $F \cap \text{HOD}$ such that F is an extender, $F \cap \text{HOD} \in \text{HOD}$, and such that $F \cap \text{HOD}$ is an extender in HOD .

Suppose that there is a proper class of Woodin cardinals and that δ is an extendible cardinal. Must $\mathcal{E}(\text{HOD}:V)$ witness in HOD that δ is a supercompact cardinal?

A positive solution to this question would have significant consequences in Set Theory independent of whether the solution has anything to do with the Inner Model Program.

I give an example. Consider the ultimate large cardinal axiom—that of the existence of a Reinhardt cardinal—which asserts there is a nontrivial elementary embedding $j : V \rightarrow V$. This axiom as I have noted is refuted by the Axiom of Choice. But is the axiom consistent with ZF? The axiom AD is refuted by the Axiom of Choice and yet as we have seen, not only is $\text{ZF} + \text{AD}$ consistent (the theory holds in $L(\mathbb{R})$), this theory is of fundamental interest (again because it holds in $L(\mathbb{R})$).

But the existence of a Reinhardt cardinal can be shown to *imply* the consistency *with* the Axiom of Choice of all the other large cardinal axioms I have mentioned [29]. So what can possibly provide the basis for the claim that the existence of Reinhardt cardinals is consistent with ZF? Certainly not their existence since that would deny the Axiom of Choice.

A positive answer to the question above would yield as a corollary that in ZF if there is a proper class of supercompact cardinals then *there are no Reinhardt cardinals* and very likely yield the outright nonexistence of Reinhardt cardinals—this would resolve a key foundational issue. More fundamentally and in an ironic twist since one early motivation of the study of the projective sets was a rejection of the Axiom of Choice, the positive answer will reveal deep connections between large cardinal axioms and *proving* instances of the Axiom of Choice [29].

The second question is a variant of the first question and the formulation involves the universally Baire sets. The positive solution to this question arguably must involve the successful extension of the Inner Model Program to the level of one supercompact cardinal.

Suppose that there is a proper class of Woodin cardinals and that there is a supercompact cardinal. Must there exist δ and $\mathbb{E} \subset \text{Ord}$ such that for all $x \in \mathbb{R} \cap L[\mathbb{E}]$ there is a universally Baire set $A \subseteq \mathbb{R}$ such that:

- (1) δ is supercompact in $L[\mathbb{E}]$ and this is witnessed in $L[\mathbb{E}]$ by $\mathcal{E}(L[\mathbb{E}]:V)$.
- (2) $x \in N$ where N is HOD as defined in $L(A, \mathbb{R})$?

The answer to the latter question is yes for Woodin cardinals. These are difficult constructions which evolved over 20 years and involved substantial contributions from quite a number of mathematicians. The basic definitions in their current form are due primarily to Mitchell and Steel over the period 1988-1999, [17] with revisions [26]. This work was based on earlier work of Martin and Steel [16], Dodd and Jensen (and others), and there is an alternative scheme which has subsequently been developed by Jensen, [9].

11. The Axiom for Ultimate- L

Even if one has identified the *construction* of ultimate- L this does not obviously yield the *axiom* that V is ultimate- L . This is in part because not all the extenders used in the construction survive as extenders in the inner model. The isolation of the axiom requires a much deeper understanding of the construction and this is an important issue in the whole program which I have ignored until now.

By combining the three notions of universally Baire sets, relative constructibility, and HOD, I can formulate what I conjecture will be the axiom that V is ultimate- L . I do this in the context that there is a supercompact cardinal and a proper class of Woodin cardinals though the latter is ultimately irrelevant.

The formulation of this axiom involves one last definition. Suppose that $A \subseteq \mathbb{R}$ is universally Baire. Then $\Theta^{L(A, \mathbb{R})}$ is the supremum of the ordinals α such that there is a surjection, $\pi : \mathbb{R} \rightarrow \alpha$, such that $\pi \in L(A, \mathbb{R})$.

The connection between the determinacy of the projective sets and Woodin cardinals generalizes to a structural connection illustrated by the following theorem where $\text{HOD}^{L(A, \mathbb{R})}$ denotes HOD as defined within $L(A, \mathbb{R})$.

Theorem 35 (Woodin). *Suppose that there is a proper class of Woodin cardinals and that A is universally Baire. Then $\Theta^{L(A, \mathbb{R})}$ is a Woodin cardinal in $\text{HOD}^{L(A, \mathbb{R})}$. \square*

The connection runs much deeper as indicated by the following theorem of Steel. The Mitchell-Steel extender models are the inner models $L[\mathbb{E}]$ which provide solutions of the Inner Model Program at the level of Woodin cardinals which I alluded to in the discussion after the two test questions.

Theorem 36 (Steel). *Suppose that there is a proper class of Woodin cardinals. Let $\delta = \Theta^{L(\mathbb{R})}$. Then $\text{HOD}^{L(\mathbb{R})} \cap V_\delta$ is a Mitchell-Steel extender model.* \square

Theorem 37 (Woodin). *Suppose that there is a proper class of Woodin cardinals. Then $\text{HOD}^{L(\mathbb{R})}$ is not a Mitchell-Steel extender model.* \square

But then what is $\text{HOD}^{L(\mathbb{R})}$? It belongs to a different, previously unknown, class of extender models, these are the *strategic extender models*. For a significant initial segment of the universally Baire sets, $\text{HOD}^{L(A, \mathbb{R})}$ has been verified to be a strategic extender model and there is very strong evidence that this will be true for all universally Baire sets. Until recently it was not clear at all what large cardinal axioms could hold in these models. But on the basis of the foundational questions which I have been discussing combined with associated mathematical developments, [29], there is compelling evidence (to me) that these inner models $\text{HOD}^{L(A, \mathbb{R})} \cap V_\delta$ where $\delta = \Theta^{L(A, \mathbb{R})}$ cannot be limiting in any way: the only issue (assuming these are strategic extender models) is whether strategic extender models can exist at the level of one supercompact cardinal for then just as is the case for extender models, they are transcendent for large cardinals. There is absolutely compelling evidence that strategic extender models exist which are transcendent for Ω -logic in the sense of Theorem 32 and from this perspective it seems perhaps obvious that there must exist strategic extender models at the level of one supercompact cardinal as well. The underlying point here is that the family of inner models $\text{HOD}^{L(A, \mathbb{R})} \cap V_\delta$ where $\delta = \Theta^{L(A, \mathbb{R})}$ and A is universally Baire are collectively transcendent for Ω -logic. Therefore if these inner models are strategic extender models then strategic extender models are transcendent for Ω -logic as well.

Extending the theory of extender models to the level of one supercompact cardinal seems difficult enough, why should there be any optimism that this can be done for strategic extender models the theory of which has generally been more difficult. There is a key and fundamental difference. The structure and theory of strategic extender models will be fully revealed by the inner models $\text{HOD}^{L(A, \mathbb{R})}$ where A is universally Baire. So the mathematical problem is not one of finding the correct definition to satisfy a possibly vague goal, but rather of the analysis of structures we can already define. Moreover we have a rich framework provided by determinacy in which to undertake that analysis. I should emphasize that prior to the proof of Theorem 37, it was not known if strategic extender models could exist in any reasonable form.

I now come to my main conjecture which is the conjecture that the following axiom is the axiom that V is ultimate- L . The formulation of the axiom involves rank-existential sentences as opposed to rank-universal sentences. However it can be shown that the axiom is expressible as a rank-universal sentence modulo

the indicated large cardinal hypothesis. There are natural refinements of the axiom, for example one can allow more complicated sentences and one can enlarge $L(A, \mathbb{R})$ to $L(\Gamma, \mathbb{R})$ where Γ is a suitable initial segment of the universally Baire sets.

Axiom. There is a proper class of Woodin cardinals. Further for each rank-existential sentence ϕ , if ϕ holds in V then there is a universally Baire set $A \subseteq \mathbb{R}$ such that

$$\text{HOD}^{L(A, \mathbb{R})} \cap V_\Theta \models \phi$$

where $\Theta = \Theta^{L(A, \mathbb{R})}$. □

Of course one could have made this conjecture independent of the recent results about the maximality of the inner model for one supercompact cardinal. But it is precisely these results which make this conjecture plausible and which provide a realistic scenario for proving that the axiom above is in fact the axiom that V is ultimate- L . In [28] and [29] a number of partial results concerning this conjecture are proved.

Far more speculative is the conjecture which I also make for all of the reasons discussed at length in [29]: *The axiom above is true*. By this I mean that the axiom will eventually be validated on the basis of accepted and compelling principles of infinity exactly as the axiom of Projective Determinacy has been validated.

This axiom implies the Continuum Hypothesis as well as the Ω Conjecture and together with its natural refinements will arguably reduce all questions of Set Theory to axioms of strong infinity and so banish the specter of undecidability as demonstrated by Cohen's method of forcing.

References

- [1] Paul J. Cohen. The independence of the Continuum Hypothesis. I. *Proc. Nat. Acad. Sci. U.S.A.*, 50:1143–1148, 1963.
- [2] Paul J. Cohen. The independence of the Continuum Hypothesis. II. *Proc. Nat. Acad. Sci. U.S.A.*, 51:105–110, 1964.
- [3] Anthony J. Dodd. *The Core Model*. Lecture Notes in Mathematics #61, London Mathematics Society. Cambridge University Press, Cambridge, U.K., 1982.
- [4] Qi Feng, Menachem Magidor, and W. Hugh Woodin. Universally Baire sets of reals. In H. Judah, W. Just, and H. Woodin, editors, *Set Theory of the Continuum*, volume 26 of *Mathematical Sciences Research Institute Publications*, pages 203–242, Heidelberg, 1992. Springer–Verlag.
- [5] David Gale and Frank M. Stewart. Infinite games with perfect information. In Harold W. Kuhn and Alan W. Tucker, editors, *Contributions to the Theory of Games*, volume 28 of *Annals of Mathematical Studies*, pages 245–266. Princeton University Press, Princeton, 1953.

-
- [6] Kurt F. Gödel. The consistency of the Axiom of Choice and of the Generalized Continuum Hypothesis. *Proc. Nat. Acad. Sci. U.S.A.*, 24:556–557, 1938.
- [7] Kurt F. Gödel. Consistency-proof for the Generalized Continuum Hypothesis. *Proc. Nat. Acad. Sci. U.S.A.*, 25:220–224, 1939.
- [8] Joel David Hamkins and W. Hugh Woodin. Small forcing creates neither strong nor Woodin cardinals. *Proc. Amer. Math. Soc.*, 128(10):3025–3029, 2000.
- [9] R. Jensen. A new fine structure for mice below one Woodin cardinal. Handwritten notes, (Berlin) 1997.
- [10] Akihiro Kanamori. *The higher infinite*. Perspectives in Mathematical Logic. Springer-Verlag, Berlin, 2008. Large cardinals in set theory from their beginnings; second edition.
- [11] Peter Koellner and W. Hugh Woodin. Large cardinals from determinacy. In Matthew Foreman and Akihiro Kanamori, editors, *Handbook of Set Theory*, volume III, pages 1951–2120. Springer-Verlag, New York, 2010.
- [12] Kenneth Kunen. Some applications of iterated ultrapowers in set theory. *Ann. Math. Logic*, 11:179–227, 1977.
- [13] Nikolai N. Luzin. Sur les ensembles projectifs de M. Henri Lebesgue. *Comptes Rendus Hebdomadaires des Séances de l'Académie des Sciences, Paris*, 180:1572–1574, 1925.
- [14] Nikolai N. Luzin. Sur le problème de M. J. Hadamard d'uniformisation des ensembles. *Comptes Rendus Hebdomadaires des Séances de l'Académie des Sciences, Paris*, 190:349–351, 1930.
- [15] D. A. Martin and J. Steel. A proof of projective determinacy. *J. Amer. Math. Soc.*, 2:71–125, 1989.
- [16] D. A. Martin and J. Steel. Iteration trees. *J. Amer. Math. Soc.*, 7:1–74, 1994.
- [17] William J. Mitchell and John R. Steel. *Fine structure and iteration trees*. Springer-Verlag, Berlin, 1994.
- [18] Yiannis N. Moschovakis. *Descriptive set theory*. North-Holland Publishing Co., Amsterdam, 1980.
- [19] Jan Mycielski and Stanisław Swierczkowski. On the Lebesgue measurability and the Axiom of Determinateness. *Fund. Math.*, 54:67–71, 1964.
- [20] Jan Mycielski and Hugo Steinhaus. A mathematical axiom contradicting the Axiom of Choice. *Bulletin de l'Académie Polonaise des Sciences, Série des Sciences Mathématiques, Astronomiques et Physiques (continued from 1983 by Bulletin of the Polish Academy of Sciences. Mathematics.)*, 10:1–3, 1962.
- [21] G. Sargsyan. *A tale of hybrid mice*. PhD thesis, U.C. Berkeley, 2009.
- [22] F. Schlutzenberg. *Measures in mice*. PhD thesis, U.C. Berkeley, 2007.
- [23] Dana S. Scott. Measurable cardinals and constructible sets. *Bulletin de l'Académie Polonaise des Sciences, Série des Sciences Mathématiques, Astronomiques et Physiques (continued from 1983 by Bulletin of the Polish Academy of Sciences. Mathematics.)*, 9:521–524, 1961.
- [24] Jack H. Silver. Measurable cardinals and Δ_3^1 well-orderings. *Ann. of Math.*, 94:414–446, 1971.

- [25] Robert M. Solovay. A model of set theory in which every set of reals is Lebesgue measurable. *Ann. of Math.*, 92:1–56, 1970.
- [26] John Steel, Ralf Schindler, and Martin Zeman. Deconstructing inner model theory. *J. Symbolic Logic*, 67(June):712–736, 2002.
- [27] William W. Wadge. Degrees of complexity of subsets of the baire space. *Notices Amer. Math. Soc.*, 19, 1972. Abstract 714.
- [28] W. Hugh Woodin. The fine structure of suitable extender sequences. Preprint, 2010.
- [29] W. Hugh Woodin. Suitable extender models. Preprint, 2010.

Equidistribution in Homogeneous Spaces and Number Theory

Elon Lindenstrauss*

Abstract

We survey some aspects of homogeneous dynamics — the study of algebraic group actions on quotient spaces of locally compact groups by discrete subgroups. We give special emphasis to results pertaining to the distribution of orbits of explicitly describable points, especially results valid for the orbits of *all* points, in contrast to results that characterize the behavior of orbits of *typical* points. Such results have many number theoretic applications, a few of which are presented in this note. Quantitative equidistribution results are also discussed.

Mathematics Subject Classification (2010). Primary 37A17; Secondary 37A45, 11J13, 11B30, 11J71

Keywords. invariant measures, homogeneous spaces, geometry of numbers, quantitative equidistribution, arithmetic combinatorics, quantum unique ergodicity, entropy.

1. Introduction

1.1. In this note we discuss a certain very special class of dynamical systems of algebraic origin, in which the space is the quotient of a locally compact group G by a discrete subgroup Γ and the dynamics is given by the action of some closed subgroup $H < G$ on G/Γ by left translations, or more generally by the action of a subgroup of the group of affine transformations on G that descends to an action on G/Γ . There are several natural classes of locally compact groups one may consider — connected Lie groups, linear algebraic groups (over \mathbb{R} , or \mathbb{Q}_p , or perhaps general local field of arbitrary characteristic), finite products of linear algebraic groups over different fields, or the closely related case of linear algebraic groups over adèles of a global field such as \mathbb{Q} .

*The research presented was supported by the NSF (most recently by grants DMS-0554345 and DMS-0800345) and the Israel Science Foundation.

Einstein Institute of Mathematics, The Hebrew University of Jerusalem, Jerusalem, 91904, Israel and Princeton University, Princeton NJ 08540 USA. E-mail: elonl@math.princeton.edu

1.2. Such actions turn out to be of interest for many reasons, but in particular are intimately related to deep number theoretic questions. They are also closely connected to another rich area: the spectral theory of such quotient spaces, also known as the theory of automorphic forms, which has so many connections to both analytic and algebraic number theory that they are hard to separate.

From the point of view of these connections between dynamics and number theory, perhaps the most interesting quotient space is the space X_d of lattices in \mathbb{R}^d up to homothety, which is naturally identified with $\mathrm{PGL}(d, \mathbb{R})/\mathrm{PGL}(d, \mathbb{Z})$. There are several historical sources for the use of this space in number theory. One prominent historical source is H. Minkowski's work on Geometry of Numbers c. 1895; and while (like most mathematical research areas) it is hard to draw the precise boundaries of the Geometry of Numbers, certainly at its heart is a systematic use of lattices, and implicitly the space of lattices, to the study of number theoretic problems of independent interest.

The use of tools and techniques of ergodic theory and dynamical systems, and perhaps no less importantly the use of the dynamical point of view, to study these actions has proven to be a remarkably powerful method with applications in several rather diverse areas in number theory and beyond, but in particular for many of the problems considered in the Geometry of Numbers. This is a very active direction of current research sometimes referred to as Flows on Homogeneous Spaces, though the shorter term Homogeneous Dynamics seems to be gaining popularity.

1.3. We present below a Smörgåsbord of topics from the theory. The selection is somewhat arbitrary, and is biased towards aspects that I have personally worked on. A brief overview of the topics discussed in each section is given below:

- §2. Actions of unipotent and diagonalizable groups are discussed. Thanks to the deep work of several mathematicians the actions of unipotent groups are quite well understood (at least on a qualitative level). The actions of diagonalizable groups are much less understood. These diagonalizable actions behave quite differently depending on whether the acting group is one dimensional or of higher dimensions; in the latter case there are several long-standing conjectures and a few partial results toward these conjectures that are powerful enough to have applications of independent interest.
- §3. We consider why the rigidity properties of an action of a multiparameter diagonalizable group is harder to understand than actions of unipotent groups (or groups generated by unipotents), and highlight one difference between these two classes of groups: growth rates of the Haar measure of norm-balls in these groups.
- §4. Three applications of the measure classification results for multiparameter diagonalizable groups are presented: results regarding Diophantine approximations and Littlewood's Conjecture, Arithmetic Quantum Unique

Ergodicity, and an equidistribution result for periodic orbits of the diagonal group in X_3 (a problem considered by Linnik with strong connections to L -functions and automorphic forms).

- §5. We present recent progress in the study of actions of another natural class of groups that share with unipotent groups the property of large norm-balls: Zariski dense subgroups of semisimple groups or more generally groups generated by unipotents.
- §6. We conclude with a discussion of the quantitative aspects of the density and equidistribution results presented in the previous sections regarding orbits of group actions on homogeneous spaces.

2. Actions of Unipotent and Diagonalizable Groups

2.1. Part of the beauty of the subject is that for a given number theoretic application one is led to consider a very concrete dynamical system. Perhaps the best way to illustrate this point is by example. An important and influential milestone in the theory of flows on homogeneous spaces has been Margulis' proof of the longstanding Oppenheim Conjecture in the mid 1980's [Mar87]. The Oppenheim Conjecture states that if $Q(x_1, \dots, x_d)$ is an indefinite quadratic form in $d \geq 3$ variables, not proportional to a form with integral coefficients, then

$$(2.1) \quad \inf \{|Q(v)| : v \in \mathbb{Z}^d \setminus \{0\}\} = 0.$$

By restricting Q to a suitably chosen rational subspace, it is easy to reduce the conjecture to the case of $d = 3$, and instead of considering the values of an arbitrary indefinite ternary quadratic form on the lattice \mathbb{Z}^d one can equivalently consider the values an arbitrary lattice ξ in \mathbb{R}^d attains on the fixed indefinite ternary quadratic form, say $Q_0(x, y, z) = 2xz - y^2$. The symmetry group

$$\mathrm{SO}(1, 2) = \{h \in \mathrm{SL}(3, \mathbb{R}) : Q_0(v) = Q_0(hv) \text{ for all } v \in \mathbb{R}^3\}$$

is a noncompact semisimple group. By the definition of H , for every $h \in H = \mathrm{SO}(1, 2)$ and $\xi \in X_3$ the set of values Q_0 attains at nonzero vectors of the lattice ξ coincides with the set of values this quadratic form attains at nonzero vectors of the lattice $h.\xi$, i.e. the lattice obtained from ξ by applying the linear map h on each vector. It is now an elementary observation, using Mahler's Compactness Criterion, that for $\xi \in X_3$,

$$\inf \{|Q_0(v)| : v \in \xi \setminus \{0\}\} = 0 \quad \iff \quad \text{the orbit } H.\xi \text{ is unbounded.}$$

G. A. Margulis established the conjecture by showing that any orbit of H on X_3 is either periodic or unbounded (see [DM90a] for a highly accessible account); the lattices corresponding to periodic orbits are easily accounted for, and correspond precisely to indefinite quadratic forms proportional to integral forms. Here and throughout, an orbit of a group H acting on a topological space X is said to be *periodic* if it is closed and supports a finite H -invariant measure.

We note that the homogeneous space approach for studying values of quadratic forms was noted by M.S. Raghunathan who also gave a much more general conjecture in this direction regarding orbit closures of connected unipotent groups in the quotient space G/Γ . In retrospect one can identify a similar approach in the remarkable paper [CSD55] by Cassels and Swinnerton-Dyer.

2.2. This example illustrates an important point: in most cases it is quite easy to understand how a typical orbit behaves, e.g. to deduce from the ergodicity of H acting on X_3 that for almost every ξ the orbit $H.\xi$ is dense in X_3 ; but for many number theoretical applications one needs to know how orbits of individual points behave — in this case, one needs to understand the orbit $H.\xi$ for **all** $\xi \in X_3$.

2.3. Raghunathan's Conjecture regarding the orbit closures of groups generated by one parameter unipotent subgroups, as well as an analogous conjecture by S.G. Dani regarding measures invariant under such groups [Dan81] have been established in their entirety¹ in a fundamental series of papers by M. Ratner [Ra91a, Ra90a, Ra90b, Ra91b].

Theorem 1 (Ratner). *Let G be a real Lie group, $H < G$ a subgroup generated by one parameter Ad-unipotent groups, and Γ a lattice in G . Then:*

- (i) *Any H -invariant and ergodic probability measure μ on G/Γ is an L -invariant measure supported on a single periodic L -orbit of some subgroup $L \leq G$ containing H*
- (ii) *For any $x \in G/\Gamma$, the orbit closure $\overline{H.x}$ is a periodic orbit of some subgroup $L \leq G$ containing H .*

A measure μ as in (i) above will be said to be *homogeneous*.

This fundamental theorem of Ratner, which in applications is often used in conjunction with the work of Dani and Margulis on nondivergence of unipotent flows [Mar71, Dan86] and related estimates on how long a unipotent trajectory can spend near a periodic trajectory of some other group (e.g. as developed in [DM90b, DM93] or [Ra91b]) give us very good (though non-quantitative) understanding of the behavior of individual orbits of groups H generated by one

¹Special cases of Raghunathan's Conjecture were established by Dani and Margulis [DM90b] using a rather different approach.

parameter unipotent subgroups, such as the group $\mathrm{SO}(1, 2)$ considered above. It has been extended to algebraic groups over \mathbb{Q}_p and to S -algebraic groups (products $G = \prod_{p \in S} G_i(\mathbb{Q}_p)$ with the convention that $\mathbb{Q}_\infty = \mathbb{R}$) by Ratner [Ra95] and Margulis-Tomanov [MT94].

2.4. These theorems on unipotent flows have numerous number theoretical applications, much too numerous to list here. A random sample of such applications, to give a flavor of their diverse nature, is the substantial body of work regarding counting of integer and rational points on varieties, e.g. Eskin, Mozes and Shah [EMS96] who give the asymptotic behavior as $T \rightarrow \infty$ of the number of elements $\gamma \in \mathrm{SL}(d, \mathbb{Z})$ with a given characteristic polynomial satisfying $\|\gamma\| < T$ (see also H. Oh's survey [Oh10] for some more recent counting results of interest); Vatsal's proof of a conjecture of Mazur regarding non-vanishing of certain L -functions associated to elliptic curves at the critical point [Vat02]; Elkies and McMullen's study of gaps in the sequence $\sqrt{n} \bmod 1$ [EM04]; and Ellenberg and Venkatesh theorems on representing positive definite integral quadratic forms by other forms [EV08].

2.5. The action of one parameter diagonalizable groups on homogeneous spaces, such as the action of $a_t = \begin{pmatrix} e^{t/2} & 0 \\ 0 & e^{-t/2} \end{pmatrix}$ on X_2 is fairly well understood (at least in some aspects), but these \mathbb{R} -actions behave in a drastically different way than e.g. one parameter unipotent groups. The case of a_t acting on X_2 is particularly well studied. There is a close connection between this action and the continued fraction expansion of real numbers that has been used already by E. Artin [Art24], and was further elucidated by C. Series [Ser85] and others, that essentially allows one to view this system as a flow over a simple symbolic system. Any ergodic measure preserving flow of sufficiently small entropy can be realized as an invariant measure for the action of a_t on X_2 , and there is a wealth of irregular orbit closures. There is certainly also a lot of mystery remaining regarding this action and in particular due to the lack of rigidity it is extremely hard to understand the behavior of specific orbits of the action, e.g.:

Question 1. *Is the orbit of the lattice*

$$\begin{pmatrix} 1 & \sqrt[3]{2} \\ 0 & 1 \end{pmatrix} \mathbb{Z}^2$$

under the semigroup $\{a_t : t \geq 0\}$ dense in X_2 ?

Even showing that this orbit is unbounded is already equivalent to the continued fraction expansion of $\sqrt[3]{2}$ being unbounded, a well known and presumably difficult problem. While Artin constructs in [Art24] a point in X_2 which has a dense a_t -orbit in a way that can be said to be explicit, I do not know of any

construction of a lattice in X_2 generated by vectors with algebraic entries that is known to have a dense a_t -orbit.

2.6. Actions of higher rank diagonal groups are much more rigid than one parameter diagonal group, though not quite as rigid as the action of groups generated by unipotents. Many of the properties such actions are expected to satisfy are still conjectural, though there are several quite usable partial results that can be used to obtain nontrivial number theoretic consequences. A basic example of such actions is the action of the $(d-1)$ -dimensional diagonal group $A < \mathrm{PGL}(d, \mathbb{R})$ on the space of lattices X_d for $d \geq 3$. A similar phenomenon is exhibited in a somewhat more elementary setting by the action of a multiplicative semigroup Σ of integers containing at least two multiplicative independent elements on the 1-torus $\mathbb{T} = \mathbb{R}/\mathbb{Z}$. This surprising additional rigidity of multidimensional diagonalizable groups has been discovered by Furstenberg [Fur67] in the context of multiplicative semigroups acting on \mathbb{T} , and is in a certain sense implicit in the work of Cassels and Swinnerton-Dyer [CSD55].

2.7. Actions of diagonalizable groups also appear naturally in many contexts. In the aforementioned paper of Cassels and Swinnerton-Dyer [CSD55] the following conjecture is given:

Conjecture 2. *Let $F(x_1, \dots, x_d) = \prod_{i=1}^d \left(\sum_{j=1}^d g_{ij} x_j \right)$ be a product of d -linearly independent linear forms in d variables, not proportional to an integral form (as a homogeneous polynomial in d variables), with $d \geq 3$. Then*

$$(2.2) \quad \inf \{ |F(v)| : v \in \mathbb{Z}^d \setminus \{0\} \} = 0.$$

This conjecture is shown in [CSD55] to imply Littlewood's Conjecture (see §4.1), and seems to me to be the more fundamental of the two. As pointed out by Margulis, e.g. in [Mar97], Conjecture 2 is equivalent to the following:

Conjecture 2'. *Any A -orbit $A \cdot \xi$ in X_d for $d \geq 3$ is either periodic or unbounded.*

2.8. A somewhat more elementary action with similar features was studied by Furstenberg [Fur67]. Let Σ be the multiplicative semigroup of \mathbb{N} generated by two multiplicative independent integers a, b (i.e. $\log a / \log b \notin \mathbb{Q}$). In stark contrast to cyclic multiplicative semigroups, Furstenberg has shown that any Σ -invariant closed subset $X \subset \mathbb{T} = \mathbb{R}/\mathbb{Z}$ is either finite or \mathbb{T} and gave the following influential conjecture:

Conjecture 3. *Let $\Sigma = \{a^n b^k : n, k \geq 0\}$ be as above. The only Σ -invariant probability measure on \mathbb{R}/\mathbb{Z} with no atoms is the Lebesgue measure.*

This conjecture can be phrased equivalently in terms of measures on G/Γ invariant under left translation by a rank two diagonalizable group H for an

appropriate *solvable* group G and lattice $\Gamma < G$; e.g. if a, b are distinct primes, we can take

$$\begin{aligned} H &= \{(s, t, r) : s \in \mathbb{R}^\times, t \in \mathbb{Q}_a^\times, r \in \mathbb{Q}_b^\times, |s| \cdot |t|_a \cdot |r|_b = 1\} \\ G &= H^\times \ltimes (\mathbb{R} \times \mathbb{Q}_a \times \mathbb{Q}_b) \\ \Gamma &= \{(s, s, s) : s = a^n b^m, n, m \in \mathbb{Z}\} \ltimes \{(t, t, t) : t \in \mathbb{Z}[\frac{1}{ab}]\}. \end{aligned}$$

2.9. Ergodic theoretic entropy is a key invariant in ergodic theory whose introduction in the late 1950s by Kolmogorov and Sinai completely transformed the subject. At first sight it seems quite unrelated to the type of questions considered above. However, it has been brought to the fore in the study of multiparameter diagonalizable actions by D. Rudolph (based on earlier work of R. Lyons [Lyo88]), who established an important partial result towards Furstenberg's Conjecture (Conjecture 3): Rudolph classified such measures under a positive entropy condition [Rud90]. A. Katok and R. Spatzier were the first to extend this type of results to flows on homogeneous spaces [KS96], but due to a subtle question regarding ergodicity of subactions their results do not seem to be applicable in the number theoretic context.

2.10. Some care needs to be taken when stating the expected measure classification result for actions of multiparameter diagonalizable groups on a quotient space G/Γ , even for $G = \mathrm{PGL}(3, \mathbb{R})$ and A the full diagonal group, since as pointed out by M. Rees [Ree82] (see also [EK03, §9]), any such conjecture should take into account possible scenarios where the action essentially degenerates into a one parameter action where no such rigidity occurs. An explicit conjecture regarding measures invariant under multiparameter diagonal flows was given by Margulis in [Mar00, Conjecture 2]; a similar but less explicit conjecture by Katok and Spatzier was given in [KS96], and by Furstenberg (unpublished). For the particular case of the action of the diagonal group A on the space of lattice in X_d such degeneration cannot occur² and one has the following conjecture:

Conjecture 4. *Let μ be an A -invariant and ergodic probability measure on X_d for $d \geq 3$ (and $A < \mathrm{PGL}(3, \mathbb{R})$ the group of diagonal matrices). Then μ is homogeneous (cf. §2.3).*

More generally, we quote the following from [EL06]:

Conjecture 5. *Let S be a finite set of places for \mathbb{Q} and for every $v \in S$ let G_v be a linear algebraic group over \mathbb{Q}_v . Let $G_S = \prod_{v \in S} G_v$, $G \leq G_S$ closed, and $\Gamma < G$ discrete. For each $v \in S$ let $A_v < G_v$ be a maximal \mathbb{Q}_v -split torus,*

²For *probability* measures; there are non-homogeneous A -invariant and ergodic Radon measures on X_d .

and let $A_S = \prod_{v \in S} A_v$. Let A be a closed subgroup of $A_S \cap G$ with at least two independent elements. Let μ be an A -invariant and ergodic probability measure on G/Γ . Then at least one of the following two possibilities holds:

- (i) μ is homogeneous, i.e. is the L -invariant measure on a single, finite volume, L -orbit for some closed subgroup $A \leq L \leq G$.
- (ii) There is some S -algebraic subgroup L_S with $A \leq L_S \leq G_S$, an element $x \in G/\Gamma$, an algebraic homeomorphism $\phi : L_S \rightarrow \tilde{L}_S$ onto some S -algebraic group \tilde{L}_S , and a closed subgroup $H < \tilde{L}_S$ with $H \geq \phi(\Gamma)$ so that (i) $\mu((L_S \cap G).x_\Gamma) = 1$, (ii) $\phi(A)$ does not contain two independent elements and (iii) the image of μ to \tilde{L}_S/H is not supported on a single point.

2.11. To obtain a measure classification result in the homogeneous spaces setting with only an entropy assumption and no assumptions regarding ergodicity of subactions (which are nearly impossible to verify in most applications of the type considered here) requires a rather different strategy of proof than [KS96], using two different and complementary methods. The first, known as the *high entropy method*, was developed by M. Einsiedler and Katok [EK03] and utilizes non-commutativity of the unipotent subgroups normalized by the acting group, and e.g. in the case of A acting on X_d for $d \geq 3$ allows one to conclude that any measure of sufficiently high entropy (or positive entropy in “sufficiently many directions”) is the uniform measure. The other method, the *low entropy method*, was developed by the author [Lin06] where in particular an analogue to Rudolph’s theorem for the action of the maximal \mathbb{R} -split torus³ on $\mathrm{SL}(2, \mathbb{R}) \times \mathrm{SL}(2, \mathbb{R})/\Gamma$ is given. Even though the measure under study is invariant under a diagonalizable group and a priori has no invariance under any unipotent element, ideas from the theory of unipotent flows, particularly from a series of papers of Ratner on the horocycle flow [Ra82a, Ra82b, Ra83], are used in an essential way. These two methods can be combined successfully as was done in a joint paper with Einsiedler and Katok [EKL06] where the following partial result toward Conjecture 4 is established:

Theorem 2 ([EKL06]). *Let A be the group of diagonal matrices as above and $d \geq 3$. Let μ be an A -invariant and ergodic probability measure on X_d . If for some $a \in A$ the entropy $h_\mu(a) > 0$ then μ is homogeneous.*

2.12. The high entropy method was developed further by Einsiedler and Katok in [EK05] and the low entropy method was developed further by Einsiedler and myself in [EL08]; these can be combined to give in particular the following theorem, which we state for simplicity for real algebraic groups but holds in

³Which in this case is simply the product of the diagonal group from each factor

the general S -algebraic setting of Conjecture 5 (see [EL06, §2.1.4] for more details⁴):

Theorem 3. *Let G be a semisimple real algebraic group, $A < G$ the connected component of a maximal \mathbb{R} -split torus, and $\Gamma < G$ an irreducible lattice. Let μ be an A -invariant and ergodic probability measure on G/Γ . Assume that:*

- (i) *the \mathbb{R} -rank of G is ≥ 2*
- (ii) *there is no reductive proper subgroup $L < G$ so that μ is supported on a single periodic L -orbit*
- (iii) *there is some $a \in A$ for which $h_\mu(a) > 0$.*

Then μ is the uniform measure on G/Γ .

If (ii) does not hold, one can reduce the classification of A -invariant measures μ on this periodic L -orbit to the classification of $A \cap [L, L]$ -invariant and ergodic measures μ' on $[L, L]/\Lambda$, with Λ a lattice in $[L, L]$. If Λ is reducible, up to finite index, $[L, L]/\Lambda = \prod_{i=1}^s L_i/\Lambda_i$ and $\mu = \prod_{i=1}^s \mu'_i$, with μ'_i an $A \cap L_i$ -invariant measure on L_i/Λ_i . As long as there is some L_i with \mathbb{R} -rank ≥ 2 and some element $a' \in A \cap L_i$ with $h_{\mu'_i}(a') > 0$, one can apply Theorem 3 recursively to obtain a more explicit, but less concise measure classification result.

New ideas seem to be necessary to extend Theorem 3 to non-maximally split tori; in part this seems to be related to the fact that for non-maximal A much more general groups L , even solvable ones, need to be considered in case (ii).

3. A Remark on Invariant Measures, Individual Orbits, and Size of Groups

3.1. One important difference between a group H generated by unipotent one parameter subgroups (considered as a subgroup of some ambient algebraic group G , which for simplicity we assume in this paragraph to be simple) and diagonalizable groups such as the group A of diagonal matrices in $G = \mathrm{PGL}(d, \mathbb{R})$ is the size of norm-balls in the groups H or A respectively under any nontrivial finite dimensional representation ρ of G (in particular, the adjoint representation): if λ_H and λ_A denote Haar measure on H and A respectively,

$$(3.1) \quad \lambda_H(\{h \in H : \|\rho(h)\| < T\}) \geq CT^\alpha \quad \text{for some } \alpha = \alpha(\rho) > 0$$

while

$$(3.2) \quad \lambda_A(\{a \in A : \|\rho(a)\| < T\}) \asymp (\log T)^{d-1}.$$

⁴There is a slight inaccuracy in the statement of [EL06, Thm. 2.4]: either one needs to assume to begin with that $h_\mu(a) > 0$ for some $a \in A$ or one needs to allow the trivial group $H = \{e\}$ in the first case listed there.

We shall loosely refer to groups as in (3.1) for which the volume of norm-balls is polynomial as *thick* in G , and groups where this volume is polylogarithmic as in (3.2) as *thin*.

3.2. Such norm balls appear naturally when one studies how orbits of nearby points x and y diverge — an important element of Ratner’s proof of Theorem 1. Suppose e.g. G is a linear algebraic group over \mathbb{R} , $\Gamma < G$ a lattice and $H < G$ some closed subgroup. If $x = \exp(w).y$ for $w \in \text{Lie}(G)$ small, $h.x = \exp(\text{Ad } h(w)).h.y$ and these will still be reasonably close for all $h \in H$ with $\|\text{Ad}(h)\| < \|w\|^{-1}$. One can gain in the range of usable elements of H by allowing $h.x$ to be compared with a more carefully chosen point $h'.y \in H.y$, but in any case the range of usable $h \in H$ includes elements of norm bounded at most by a polynomial in $\|w\|^{-1}$. The entropy condition of Theorems 2 and 3 can be thought of as a partial compensation for the fact that the acting group is thin.

3.3. The size of norm-balls also plays an important role in another important aspect of the dynamics, namely the extent to which the behavior of individual orbits relates to any possible classification of invariant measures. We recall the following definition due to Furstenberg:

Definition 1. Let X be a locally compact space, and H an amenable group acting continuously on X . A point $x \in X$ will be said to be *generic* for an H -invariant measure μ along a Følner sequence⁵ $\{F_n\}$ in H (that is usually kept implicit) if for any $f \in C_c(X)$

$$\lim_{n \rightarrow \infty} \frac{\int_{F_n} f(h.x) d\lambda_H(h)}{\lambda_H(F_n)} \rightarrow \int_X f(y) d\mu(y)$$

where λ_H is the left invariant Haar measure on H .

By the pointwise ergodic theorem (which in this generality can be found in [Lin01]) and separability of $C_c(X)$, if $\{F_n\}$ is a sufficiently nice Følner sequence (e.g. for $H = \mathbb{R}^k$, F_n can be taken to be any increasing sequence of boxes whose shortest dimension $\rightarrow \infty$ as $n \rightarrow \infty$), and if μ is an H -invariant and ergodic probability measure, then μ almost every $x \in X$ is generic for μ along $\{F_n\}$.

3.4. As is well-known, if X is uniquely ergodic, i.e. there is a *unique* H -invariant probability measure μ on X (which will necessarily be also H -ergodic, as the ergodic measures are the extreme points of the convex set of all H -invariant probability measures) then something much stronger is true: *every*

⁵A sequence of sets $F_n \subset H$ is said to be a Følner sequence if for any compact $K \subset G$ we have that $\lambda_H(F_n \triangle KF_n) / \lambda_H(F_n) \rightarrow 0$ as $n \rightarrow \infty$; a group H is said to be amenable if it has a Følner sequence.

$x \in X$ is generic for μ along *any* Følner sequence (we will also say in this case that the H -orbit of x is μ -equidistributed in X along any Følner sequence).

Even if there are only two H -invariant and ergodic probability measures on X , or even if there is a unique H -invariant and ergodic probability measure on X but X is not compact, individually orbits may behave in somewhat complicated ways, failing to be generic for any measure on X . The most one can say is that if $\{F_n\}$ is Følner sequence, for large n the push forward of $(\lambda_H(F_n))^{-1}\lambda_H|_{F_n}$ restricted to a large Følner set F_n under the map $h \mapsto h.x$ is close to a linear combination (depending on n) of the two H -invariant and ergodic measures in the former case, or to c times the unique H -invariant probability measure in the latter case for some $c \in [0, 1]$ (which again may depend on n).

3.5. For unipotent flows, the connection between distribution properties of individual orbits and the ensemble of invariant probability measures is exceptionally sharp. In [Ra91b] Ratner has shown that if u_t is a one parameter unipotent group, G a real Lie group, and $\Gamma < G$ a lattice then any $x \in G/\Gamma$ is generic for some homogeneous measure μ whose support contains x . A uniform version where one is allowed to vary the unipotent group as well as the starting point was given by Dani and Margulis [DM93, Thm. 2]. Another useful result in the same spirit by Mozes and Shah [MS95] classifies limits of sequences of homogeneous probability measures $(m_i)_i$ in G/Γ that are invariant and ergodic under some one parameter unipotent subgroup of G (possibly different for different i); such a limiting measure is also a homogeneous probability measure. Often if the volume of the corresponding sequence of periodic orbits goes to ∞ one can show that these homogeneous probability measures converge to the uniform measure on G/Γ . In the proof of all these results, the thickness of unipotent groups (and groups generated by unipotents), under the guise of the polynomial nature of unipotent flows, plays a crucially important role.

Even for $G = \mathrm{SL}(2, \mathbb{R})$, the connection between invariant measures and distribution properties of individual orbits for the action of unipotent groups on *infinite* volume quotients is not well understood outside the geometrically finite case, though there is some interesting work in this direction, e.g. [SS08].

3.6. For diagonalizable flows, the connection between invariant measures and behavior of individual orbits is much more tenuous. Certainly if $X = G/\Gamma$ is compact then for any $\xi \in X$ the A -orbit closure $\overline{A.\xi}$ supports an A -invariant measure: but this measure may not be unique, nor does the support of μ have to coincide with $\overline{A.\xi}$. Counterexamples given by Maucourant [Mau10] to the topological counterpart of Conjecture 5 in [Mar00] are of precisely this type: they give an A orbit whose limit set is the support of two (or more) different homogeneous measures. An example in a similar spirit has been given by U. Shapira [Sha10, LS10] for the action of the full diagonal group A on X_3 : Here

ξ is the lattice

$$\xi = \begin{pmatrix} 1 & a & 0 \\ 0 & 1 & 0 \\ 0 & a & 1 \end{pmatrix} \mathbb{Z}^3$$

which for a typical $a \in \mathbb{R}$ will spiral between two *infinite* homogeneous measures supported on the closed orbits through the standard lattice \mathbb{Z}^d of the groups

$$H_1 = \begin{pmatrix} * & * & 0 \\ * & * & 0 \\ 0 & 0 & * \end{pmatrix} \quad \text{and} \quad H_2 = \begin{pmatrix} * & 0 & 0 \\ 0 & * & * \\ 0 & * & * \end{pmatrix}.$$

3.7. In special cases *isolation results* give a weak substitute for diagonal actions to the “linearization” techniques used in [DM93, MS95, Ra91b] for unipotent flows. An isolation result of this type for the action of A on X_d for $d \geq 3$ by Cassels and Swinnerton-Dyer [CSD55]⁶ gives in particular that if $\xi, \xi_0 \in X_d$, with

$$(3.3) \quad A.\xi_0 \subset \overline{A.\xi} \setminus (A.\xi) \quad \text{and} \quad A.\xi_0 \text{ periodic}$$

then $A.\xi$ is unbounded; this has been strengthened by Barak Weiss and myself [LW01] to show that under the same assumptions $\overline{A.\xi}$ is a periodic orbit of some closed connected group H with $A \leq H \leq \text{PGL}(d, \mathbb{R})$ (such periodic orbits are easily classified and in particular unless $H = A$ are unbounded). Results of this nature under somewhat less restrictive conditions than (3.3), along with some Diophantine applications, were recently given by U. Shapira and myself [LS10].

Using the Cassels Swinnerton-Dyer isolation result it is easy to show that Conjecture 4 implies Conjecture 2: indeed, if $A.\xi$ is a bounded orbit in X_d then $\overline{A.\xi}$ supports an A -invariant probability measure, and hence by the ergodic decomposition $\overline{A.\xi}$ supports an A -invariant and ergodic probability measure. Assuming Conjecture 4 this measure will be homogeneous, and by the classification alluded to in the previous paragraph the only compactly supported A -invariant homogeneous probability measures are the probability measures on periodic A -orbits. Thus $\overline{A.\xi}$ contains an A -periodic measure, and unless $A.\xi$ is itself periodic we get a contradiction to the Cassels-Swinnerton-Dyer Isolation Theorem.

3.8. The field of arithmetic combinatorics has witnessed dramatic progress over the last few years with remarkable applications. One of the basic results is the following exponential sum estimate by Bourgain, Glibichuk and Konyagin

⁶In the paper, Cassels and Swinnerton-Dyer treat only the case of $d = 3$, but the general case is similar.

[BGK06]: for any δ there are $c, \epsilon > 0$ so that if p is prime, \tilde{H} a subgroup of $(\mathbb{Z}/p\mathbb{Z})^\times$ with $|\tilde{H}| > p^\delta$,

$$\max_{b \in (\mathbb{Z}/p\mathbb{Z})^\times} \frac{|\sum_{h \in \tilde{H}} e(bh/p)|}{|\tilde{H}|} < cp^{-\epsilon}$$

with $e(x) = \exp(2\pi ix)$. Bourgain has proved a similar estimate with p replaced by an arbitrary integer N ; this involves considerable technical difficulties since one is interested in a result in which the error term does not depend on the decomposition of N into primes. If \tilde{H} is the reduction modulo N of some multiplicative semigroup $H \subset \mathbb{Z}^\times$, we can interpret this estimate as saying that for any $0 \leq b < N$, the periodic H -orbit $\left\{ \frac{hb}{N} \bmod 1 : h \in \tilde{H} \right\}$ is close to being equidistributed in \mathbb{T} in a quantitative way provided $|\tilde{H}| > N^\delta$.

3.9. Of particular interest to us is the semigroup $H = \{a^n b^k : n, k \in \mathbb{N}\}$ where a, b are multiplicatively independent integers. For a certain sequence of N_i (relatively prime to ab) it may well happens that $|H \bmod N| > N^\delta$ for a fixed δ , even though H is a thin sequence in the sense of §3.1. For such a sequence N_i and any choice of $b_i \in (\mathbb{Z}/N_i\mathbb{Z})^\times$, the sequence of periodic H -orbits $H \cdot \frac{b_i}{N_i} \bmod 1$ would become equidistributed in a quantitative way as $i \rightarrow \infty$ by the theorem of Bourgain quoted above (§3.8). However there are sequences of N for which $|H \bmod N|$ is rather small — $(\log N)^{c \log \log \log N}$ [APR83]. A trivial lower bound on $|H \bmod N|$ is

$$|H \bmod N| \geq (\log_a N)(\log_b N)/2,$$

and if there were infinitely many N_i with $|H \bmod N_i| \ll (\log N_i)^2$ then the orbits $H \cdot \frac{1}{N_i} \bmod 1$ would spend a positive proportion of their mass very close to 0, and hence fail to equidistribute.

Using the Schmidt Subspace Theorem (more precisely, its S -algebraic extension by Schlickewei) in an elegant and surprising way Bugeaud, Corvaja and Zannier [BCZ03] show that

$$\lim_{N \rightarrow \infty} \frac{|H \bmod N|}{(\log N)^2} \rightarrow \infty$$

giving credence to the following conjecture, presented as a question by Bourgain in [Bou09]:

Conjecture 6. *Let $H = \{a^n b^k : n, k \in \mathbb{N}\}$, with a, b multiplicatively independent. Then for any sequence $\{(b_i, N_i)\}$ with $N_i \rightarrow \infty$ and $b_i \in (\mathbb{Z}/N_i\mathbb{Z})^\times$ the sequence of H -periodic orbits $H \cdot \frac{b_i}{N_i} \bmod 1$ becomes equidistributed as $i \rightarrow \infty$, i.e. for any $f \in C(\mathbb{T})$,*

$$|H|^{-1} \sum_{h \in H} f\left(h \cdot \frac{b_i}{N_i}\right) \rightarrow \int_{\mathbb{T}} f dx.$$

Even if one assumes (or proves) Conjecture 3 regarding H -invariant measures, this conjecture seems challenging due to the absence of a strong connection between individual orbits and invariant measures for diagonalizable group actions (cf. §3.6).

4. Some Applications of the Rigidity Properties of Diagonalizable Group Actions

4.1. The partial measure classification results for actions of diagonalizable groups mentioned above, e.g. Theorems 2 and 3, have several applications. We give below a sample of three theorems, in the proof of which one of the major ingredients is the classification of positive entropy invariant measures. Several other applications are discussed in Einsiedler's notes for his lecture at this ICM [Ein10]⁷.

Multiparameter diagonal groups and Diophantine approximations.

4.2. Using the variational principle relating topological entropy and ergodic theoretic entropy, together with an averaging argument and use of semicontinuity properties of entropy for measures supported on compact subsets of X_d in [EKL06] the following partial result towards Conjecture 2 was deduced from Theorem 2 (see either [EKL06] or [EL10, §12] for more details):

Theorem 4 (Einsiedler, Katok and L. [EKL06]). *The set of degree d homogeneous polynomials $F(x_1, \dots, x_d)$ that can be factored as a product of d linearly independent forms in d variables that fail to satisfy (2.2) have Hausdorff dimension zero.*

By Conjecture 2 above, the set of such F is expected to be countable; the trivial upper bound on the dimension of the set of such F is $d(d-1)$.

4.3. Recall the following well known conjecture of Littlewood regarding simultaneous Diophantine approximations:

Conjecture 7 (Littlewood). *For any $x, y \in \mathbb{R}^2$,*

$$(4.1) \quad \inf \{n |nx - m| |ny - k| : (n, m, k) \in \mathbb{Z}^3, n \neq 0\} = 0.$$

⁷Einsiedler and I have worked together for some years on many aspects of the action of diagonalizable groups, and there is some overlap between this paper and Einsiedler's [Ein10], as well as our joint contribution to the proceedings of the previous ICM in Madrid [EL06]. However the selection of topics and style is quite different in these three papers.

Similar ideas as in the proof of Theorem 4 allows one to prove that the Hausdorff dimension of the set of exceptional pairs $(x, y) \in \mathbb{R}^2$ that do not satisfy (4.1) is zero. Indeed, one can be a bit more precise: for a sequence of integers $(a_k)_{k \in \mathbb{N}}$ define its combinatorial entropy as

$$h_{comb}((a_k)) = \lim_{n \rightarrow \infty} \frac{\log W_n((a_k))}{n}$$

where $W_n((a_k))$ counts the number of possible n -tuples $(a_k, a_{k+1}, \dots, a_{k+n-1})$ (if (a_k) is unbounded, $W_n((a_k)) = \infty$). Then the techniques of [EKL06] gives the following explicit sufficient criterion for a real number x to satisfy Littlewood’s conjecture for all $y \in \mathbb{R}$:

Theorem 5. *Let $x = a_1 + \frac{1}{a_2 + \frac{1}{a_3 + \dots}}$ be the continued fraction expansion*

of $x \in \mathbb{R}$. If $h_{comb}((a_k)) > 0$ then for every $y \in \mathbb{R}$ equation (4.1) holds.

Periodic orbits of diagonal groups.

4.4. Unlike the case for groups generated by unipotents, it is not hard to give a sequence of A -periodic orbits $A.x_i$ in X_d (for any $d \geq 2$) so that the associated probability measures $m_{A.x_i}$ fail to converge to the uniform measure (cf. [ELMV09, §7]). Indeed, as pointed out to me by U. Shapira, such an example is implicit already in an old paper by Cassels [Cas52].

4.5. However, when the periodic orbits are appropriately grouped their behavior improves markedly: define for any A -periodic $\xi \in X_d$ an order in the ring D of $d \times d$ (possibly singular) diagonal matrices by

$$\mathcal{O}(\xi) = \{h \in D : h.\bar{\xi} \subseteq \bar{\xi}\}$$

where $\bar{\xi}$ is a lattice representing the homothety equivalence class ξ . This is a discrete subring of D containing 1; $\text{stab}_A(\xi) = \{a \in A : a.\xi = \xi\}$ is precisely the set of invertible elements of $\mathcal{O}(\xi)$ and moreover $\mathbb{Z}[\text{stab}_A(\xi)] \subseteq \mathcal{O}(\xi)$. Since ξ is A -periodic, $\text{stab}_A(\xi)$ contains $d - 1$ -independent units and $\mathcal{O}(\xi)$ is a lattice in D (considered as an additive group), isomorphic as a ring to an order in a totally real number field K of degree d over \mathbb{Q} . For a given order $\mathcal{O} < D$ set

$$\mathcal{C}(\mathcal{O}) = \{A.y : \mathcal{O}(y) = \mathcal{O}\};$$

for any A -periodic $\xi \in X_d$ the collection $\mathcal{C}(\mathcal{O}(\xi))$ can be shown to be finite.

Theorem 6 (Einsiedler, Michel, Venkatesh and L. [ELMV10]). *Let $A.x_i$ can be a sequence of distinct A -periodic orbits in X_3 , and set $\mathcal{C}_i = \mathcal{C}(\mathcal{O}(x_i))$. Then for any $f \in C_c(X_3)$ we have that*

$$\frac{1}{|\mathcal{C}_i| \cdot |A/\text{stab}_A(x_i)|} \sum_{A.y \in \mathcal{C}_i} \int_{A/\text{stab}_A(x_i)} f(a.y) da \rightarrow \int_{X_3} f.$$

For $d = 2$ the corresponding statement is a theorem of Duke [Duk88] proved using the theory of automorphic forms, with some previous substantial partial results by Linnik and Skubenko (see [Li68]). Weaker results about the distribution of periodic A -orbits for $d \geq 3$ in substantially greater generality were obtained in [ELMV09].

4.6. In the case of periodic A -orbits $A.\xi$ whose corresponding order $\mathcal{O}(\xi)$ is maximal (equivalently, is isomorphic to the full integer ring \mathcal{O}_K of a totally real number field K), $\mathcal{C}(\xi)$ can be identified with the ideal class group of \mathcal{O}_K , and in particular has a natural structure of a group. It is quite challenging to make use of the group structure of $\mathcal{C}(\xi)$ in the dynamical context. In particular, it would be of interest to prove equidistribution of the collection of A -orbits corresponding to (possibly quite small) subgroups of the ideal class group.

4.7. We refer the reader to the comprehensive survey [MV06] by Michel and Venkatesh for more details on this and related equidistribution questions.

Diagonal flows and Arithmetic Quantum Unique Ergodicity.

4.8. In [RS94], Z. Rudnick and P. Sarnak conjectured the following:

Conjecture 8. *Let M be a compact Riemannian manifold of negative sectional curvature. Let ϕ_i be an orthonormal sequence of eigenfunctions of the Laplacian on M . Then*

$$(4.2) \quad \int_M f(x) |\phi_i(x)|^2 d \text{vol}(x) \rightarrow \frac{1}{\text{vol}(M)} \int_M f(x) d \text{vol}(x) \quad \forall f \in C^\infty(M).$$

There is also a slightly stronger form of this conjecture for test functions in phase space. Both versions of the conjecture are open, and there does not seem to be strong evidence for it in high dimensions. However in the special case of $M = \mathbb{H}/\Gamma$ with Γ an arithmetic lattice of congruence type (either congruence sublattices of $\text{PGL}(2, \mathbb{Z})$ or of $\text{PGL}(1, \mathcal{O})$ for \mathcal{O} an order in an indefinite quaternion algebra over \mathbb{Q} ; in the latter case M is compact) we have a lot of extra symmetry that aids the analysis: an infinite commuting ensemble of self-adjoint operators, generated by the Laplacian and, for each prime p outside a possible finite set P of “bad” primes, a corresponding Hecke operators T_p .

Theorem 7 (Brooks and L. [BL10, Lin06]). *Let $M = \mathbb{H}/\Gamma$ be as above, and $p \notin P$, with M compact. Then any orthonormal sequence ϕ_i of joint eigenfunctions of the Laplacian and T_p on M satisfies (4.2).*

This theorem refines a previous theorem that relied on work by Bourgain and myself [BL03]. When Γ is a congruence subgroup of $\text{SL}(2, \mathbb{Z})$, i.e. M is not compact, there is an extra complication in that one needs to show that no mass

escapes to the cusp in the limit. Under the assumption of ϕ_i being joint eigenfunctions of all Hecke operators this has been established by Soundararajan [Sou09].

4.9. The proof of Theorem 7 does not quite use multiparameter diagonalizable flows but rather the following theorem (generalized in [EL08]) of similar but somewhat more general flavor:

Definition 2. Let X be locally compact space, H a locally compact group acting continuously on X , and μ any σ -finite measure on X (not necessarily H invariant). Then μ is H -recurrent if for every set $B \subset X$ with $\mu(B) > 0$ for almost every $x \in X$ the set $\{h \in H : h.x \in B\}$ is unbounded (has noncompact closure).

Theorem 8 ([Lin06]). Let $G = \text{PGL}(2, \mathbb{R}) \times \text{PGL}(2, \mathbb{Q}_p)$, $H = \text{PGL}(2, \mathbb{Q}_p)$ considered as a subgroup of G , A_1 the diagonal subgroup of $\text{SL}(2, \mathbb{R})$ (also considered as a subgroup of G), and $\Lambda < G$ an irreducible lattice. Let μ be a probability measure on G/Λ which is (i) A_1 -invariant (ii) H -recurrent (iii) a.e. A_1 -ergodic component of μ has positive entropy (with respect to A_1). Then μ is the uniform measure on G/Λ .

Note that if μ as in Theorem 8 were invariant under any unbounded subgroup of H , by Poincaré recurrence it would be H -recurrent.

The connection to Theorem 7 uses the fact that for $\Gamma < \text{PGL}(2, \mathbb{R})$ of congruence type as above and $p \notin P$, \mathbb{H}/Γ can be identified with $K \backslash G/\Lambda$ for G as in Theorem 8 and $K < G$ the compact subgroup $\text{PO}(2, \mathbb{R}) \times \text{PGL}(2, \mathbb{Z}_p)$; let $\pi : G/\Lambda \rightarrow \mathbb{H}/\Gamma$ be the projection corresponding to this identification. The Hecke operator T_p is related to this construction as follows: for $f \in L^2(\mathbb{H}/\Gamma)$ and $\tilde{x} \in G/\Lambda$

$$[T_p f](\pi(\tilde{x})) = p^{-1/2} \int_{\text{PGL}(2, \mathbb{Z}_p) \begin{pmatrix} p & 0 \\ 0 & 1 \end{pmatrix} \text{PGL}(2, \mathbb{Z}_p)} \tilde{f} \circ \pi((e, h).\tilde{x}) dh.$$

The crux of both [BL03] and [BL10] is the verification of the entropy assumption (iii) above, which can be rephrased in terms of decay rates of measures of small tubes in G/Λ .

4.10. Note that though Theorems 4 and 5 are clearly partial results, in Theorem 6 and Theorem 7 one essentially obtains unconditionally full equidistribution statements using only the partial measure classification results currently available.

4.11. A more detailed discussion of quantum unique ergodicity in the arithmetic context can be found in Soundararajan’s contribution to these proceedings [Sou10], which also include a discussion of some recent exciting results of Holowinsky and Soundararajan [HS09] regarding an analogous question for holomorphic forms.

5. Zariski Dense Subgroups of Groups Generated by Unipotents

5.1. An important difference between groups generated by unipotent subgroups and diagonalizable groups is the size of norm balls in these groups. Given a closed subgroup $H < G$ with large norm balls, i.e. for which

$$(5.1) \quad \lambda_H(\{h \in H : \|\text{Ad}(h)\| < T\}) \geq CT^\alpha \quad \text{for some } \alpha > 0$$

the discussion in §3 might lead us to hope that we may be able to understand the behavior of individual H -orbits for the action of H on a quotient space G/Γ for a lattice $\Gamma < G$.

5.2. A natural class of groups which satisfy the thickness condition (5.1) are Zariski dense discrete subgroups Λ of semisimple algebraic groups. For instance, one may look at the action of a subgroup $\Lambda < \text{SL}(d, \mathbb{Z})$ with a large Zariski closure on \mathbb{T}^d , or at the action of a subgroup $\Lambda < G$ with large Zariski closure (in the simplest case, G) on G/Γ where G is a simple real algebraic group. Two substantial papers addressing this question appeared in the same Tata Institute Studies volume by Furstenberg [Fur98] and by N. Shah [Sh98], the latter paper addressing this question when Λ is generated by unipotent elements.

5.3. In the context of actions of subgroups $\Lambda < \text{SL}(d, \mathbb{Z})$ on \mathbb{T}^d , under the assumption of strong irreducibility of the Λ -action and that the identity component of the Zariski closure of Λ is semisimple, Muchnik [Muc05] and Guivarc'h and Starkov [GS04] show that for any $x \in \mathbb{T}^d$ the orbit $\Lambda.x$ is either finite or dense, in analogy with theorems of Furstenberg (cf. §2.8) and Berend [Ber84] who address this question in the context of the action of two or more commuting automorphisms of \mathbb{T}^d .

5.4. Groups Λ as above with a large Zariski closure are not amenable⁸, and hence in general there is no reason why the behavior of individual orbits in a continuous action of Λ on a compact (or locally compact) space X should be governed by Λ -invariant measures, even to the more limited extent manifest by actions of diagonalizable groups. A natural substitute for invariant measures in this context was suggested by Furstenberg (e.g. in [Fur98]): choose an arbitrary auxiliary probability measure ν on Λ whose support generates Λ , subject to an integrability condition, e.g. the finite moment condition $\int \|g\|^\delta d\nu(g) < \infty$ for some $\epsilon > 0$ (if Λ is finitely generated one can take ν to be finitely supported). A measure μ on X is said to be ν -stationary if

$$\nu * \mu := \int g_* \mu d\nu(g) = \mu.$$

⁸See footnote on p. 540 for a definition.

Unlike invariant measures, even in the nonamenable setting, if X is compact then for every $x \in X$ there is a ν -stationary probability measure supported on $\overline{\Lambda x}$.

5.5. In analogy with Conjecture 3, one may conjecture that if ν is a measure on $\mathrm{SL}(d, \mathbb{Z})$ whose support generates a subgroup Λ acting strongly irreducibly on \mathbb{T}^d and whose Zariski closure is semisimple, in particular if Λ is Zariski dense in $\mathrm{SL}(d, \mathbb{R})$, any ν -stationary probability measure on \mathbb{T}^d is a linear combination of Lebesgue measure $\lambda_{\mathbb{T}^d}$ and finitely supported measures each on a finite Λ -orbit. In particular, one may hope that any ν -stationary measure is in fact Λ -invariant, a phenomenon Furstenberg calls *stiffness*. Guivarc’h posed the following question, suggesting that a much stronger statement might be true: whether under the conditions above, for any $x \in \mathbb{T}^d$ with at least one irrational component,

$$(5.2) \quad \nu^{*k} * \delta_x := \underbrace{\nu * \cdots * \nu}_{k} * \delta_x \rightarrow \lambda_{\mathbb{T}^d} \quad \text{as } k \rightarrow \infty.$$

Equation (5.2) clearly implies that if μ is any nonatomic measure, $\nu^{*k} * \mu \rightarrow \lambda_{\mathbb{T}^d}$, hence it implies the above classification of ν -stationary measures.

5.6. In joint work with Bourgain, Furman and Mozes, a positive quantitative answer to Guivarc’h question is given under the assumption that Λ acts totally irreducibly on \mathbb{T}^d and has a proximal element⁹, in particular, if Λ is Zariski dense in $\mathrm{SL}(d, \mathbb{R})$:

Theorem 9 (Bourgain, Furman, Mozes and L. [BFLM10]). *Let $\Lambda < \mathrm{SL}_d(\mathbb{R})$ satisfy the assumptions above, and let ν be a probability measure supported on a set of generators of Λ satisfying the moment condition of §5.4. Then there are constants $C, c > 0$ so that if for a point $x \in \mathbb{T}^d$ the measure $\mu_n = \nu^{*n} * \delta_x$ satisfies that for some $a \in \mathbb{Z}^d \setminus \{0\}$*

$$|\widehat{\mu}_n(a)| > t > 0, \quad \text{with} \quad n > C \cdot \log \left(\frac{2\|a\|}{t} \right),$$

then x admits a rational approximation p/q for $p \in \mathbb{Z}^d$ and $q \in \mathbb{Z}_+$ satisfying

$$(5.3) \quad \left\| x - \frac{p}{q} \right\| < e^{-cn} \quad \text{and} \quad |q| < \left(\frac{2\|a\|}{t} \right)^C.$$

This proof uses in an essential way the techniques of arithmetic combinatorics, particularly a nonstandard projections theorem by Bourgain [Bou10].

⁹ An element $g \in \mathrm{SL}(d, \mathbb{R})$ is said to be proximal if it has a simple real eigenvalue strictly larger in absolute value than all other eigenvalues.

5.7. A purely ergodic theoretic approach to classifying Λ -stationary measures, as well as Λ -orbit closures, has been developed by Y. Benoist and J. F. Quint. Their approach has a considerable advantage that it is significantly more general in scope, though the analytic approach of [BFLM10] where applicable gives much more precise and quantitative information. In particular, in [BQ09] the following is proved for homogeneous quotients G/Γ :

Theorem 10 (Benoist and Quint). *Let G be the connected component of a simple real algebraic group, Γ a lattice in G . Let ν be a finitely supported probability measure on G whose support generates a Zariski dense subgroup $\Lambda < G$ then*

1. *Any non-atomic ν -stationary measure on G/Γ is the uniform measure on G/Γ .*
2. *For any $x \in G/\Gamma$, the orbit $\Lambda.x$ is either finite or dense. Moreover, in the latter case the Cesàro averages $\frac{1}{n} \sum_{k=1}^n \nu^{*k} * \delta_x$ converge weak* to the uniform measure on G/Γ .*

It is not known in this case if the sequence $\nu^{*n} * \delta_x$ converges to the uniform measure. A technique introduced by Eskin and Margulis [EM04] to establish nondivergence of the sequence of measures $\nu^{*k} * \delta_x$ on G/Γ and further developed by Benoist and Quint is used crucially in this work, and in particular gives a useful substitute in this context for the linearization techniques for unipotent flows discussed in §3.5. Some of the ideas of Ratner's Measure Classification Theorem (see §2.3) are used in the proof of Theorem 10, as well as the result itself.

6. Quantitative Aspects

6.1. As we have seen, dynamical techniques applied in the context of homogeneous spaces are extremely powerful, and have many applications in number theory and other subjects. However they have a major deficiency, in that they are quite hard to quantify. For example, Margulis' proof of the Oppenheim conjecture (*cf.* §2.1) does not give any information about the size of the smallest $v \in \mathbb{Z}^3 \setminus \{0\}$ satisfying $|Q(v)| < \epsilon$ for a given indefinite ternary quadratic form Q not proportional to a rational one (note that necessarily any quantitative statement of this type needs to be somewhat involved as the qualitative statement fails for integral Q , and any quantitative statement has to take into account how well Q can be approximated by forms proportional to rational forms of a given height.)

Contrast this with the proof by Davenport and Heilbronn [DH46] of the Oppenheim Conjecture for diagonal forms with $d \geq 5$ variables (forms of the type $Q(x_1, \dots, x_d) = \sum_i \lambda_i x_i^2$ where not all λ_i have the same sign) using a

variant of the Hardy-Littlewood circle method, from which it can be deduced¹⁰ that the shortest vector v with $|Q(v)| < \epsilon$ is $O(\epsilon^{-C})$, and the much more recent work of Götze and Margulis [GM10] who treat the general $d \geq 5$ case using substantially more elaborate analytic tools and obtain a similar quantitative estimate.

6.2. Overcoming this deficiency is an important direction of research within the theory of flows on homogeneous spaces. There is one general class in which at least in principle it had long been known that fairly sharp quantitative equidistribution statements can be given, and that is for the action of horocyclic groups. Recall that $U < G$ is said to be *horocyclic* if there is some $g \in G$ for which $U = \{u \in G : g^n u g^{-n} \rightarrow e \text{ as } n \rightarrow \infty\}$; the prototypical example is $U = \begin{pmatrix} 1 & t \\ 0 & 1 \end{pmatrix}$ in $\mathrm{SL}(2, \mathbb{R})$. Such quantitative equidistribution results have been given by Sarnak [Sar81] and Burger [Bur90, Thm. 2] and several other authors since. Even in this well-understood case, quantitative equidistribution results have remarkable applications such as in the work of Michel and Venkatesh on subconvex estimates of L -functions [Ven05, MV09].

6.3. Another case which is well understood, particularly thanks to the work of Green and Tao [GT07], is the action of a subgroup of G on $G \backslash \Gamma$ when G is *nilpotent*; these nilsystems appear naturally in the context of combinatorial ergodic theory, and have a different flavor from the type of dynamics we consider here, e.g. when G is a semisimple group or a solvable group of exponential growth.

6.4. We list below several nonhorospherical quantitative equidistribution results closer to the main topics of this note:

- (a) Using deep results from the theory of automorphic forms, and under some additional assumptions that are probably not essential, Einsiedler, Margulis and Venkatesh were able to give a quantitative analysis of equidistribution of *periodic* orbits of semisimple groups on homogeneous spaces [EMV09] with a polynomial rate of convergence — a result that I suspect should have many applications.
- (b) Let ν be a probability measure on $\mathrm{SL}(d, \mathbb{Z})$ as in §5.6. Theorem 9 quoted above from [BFLM10] gives a quantitative equidistribution statement for successive convolutions $\nu^{*n} * \delta_x$ for $x \in \mathbb{T}^d$, which in particular gives quantitative information on the random walk associated with ν on $(\mathbb{Z}/N\mathbb{Z})^d$ as $N \rightarrow \infty$ irrespective of the prime decomposition of N . This has turned out

¹⁰At least for forms that are not too well approximated by forms proportional to rational ones, though by Meyer's Theorem for $d \geq 5$ rational forms should not cause any significant complication.

to be useful in the recent work of Bourgain and P. Varjú [BV10] that show that the Cayley graphs of $\mathrm{SL}(d, \mathbb{Z}/N\mathbb{Z})$ with respect to a finite set S of elements in $\mathrm{SL}(d, \mathbb{Z})$ generating a Zariski dense subgroup of $\mathrm{SL}(d, \mathbb{R})$ are a family of expanders as $N \rightarrow \infty$ as long as N is not divisible by some fixed set of prime numbers depending on S .

- (c) In joint work with Margulis we give an effective dynamical proof of the Oppenheim Conjecture, i.e. one that does give bounds on the minimal size of a nonzero integral vector v for which $|Q(v)| < \epsilon$. The bound obtained is of the form $\|v\| \ll \exp(\epsilon^{-C})$. Nimish Shah has drawn my attention to a paper of Dani [Dan94] which has a proof of the Oppenheim conjecture that in principle is quantifiable, i.e. without the use of minimal sets or the axiom of choice, though it is not immediately apparent what quality of quantification may be obtained from his method.
- (d) In work with Bourgain, Michel and Venkatesh [BLMV09] we have given an effective version of Furstenberg's Theorem (cf. §2.8), giving in particular that if a, b are multiplicatively independent integers, for sufficiently large C depending on a, b and some $\theta > 0$, for all $N \in \mathbb{N}$ and m relatively prime to N ,

$$\left\{ \frac{a^n b^k m}{N} : 0 \leq n, k \leq C \log N \right\}$$

intersects any interval in \mathbb{R}/\mathbb{Z} of length $\gg \log \log \log N^\theta$. This has been generalized by Z. Wang [Wan10] in the context of commuting actions of toral automorphisms.

Clearly, there is ample scope for further research in this direction, particularly regarding the quality of these quantitative results and their level of generality. In particular, I think any improvement on the quality of the estimate obtained in (d) above would be quite interesting.

Acknowledgments

It has been my good fortune to be around many knowledgeable and generous mathematicians, from whom I have learned a lot, and I hope at least some traces of their insight are represented in this note. Of these I particularly want to mention Benjy Weiss, my advisor, Peter Sarnak, who has opened my eyes regarding the connections between homogeneous dynamics and many other areas, in particular quantum unique ergodicity, Manfred Einsiedler, with whom I have had a long-term collaboration that has been very meaningful to me mathematically and otherwise, Akshay Venkatesh, who was good enough to share with me his rare insight into the essence of a large swath of mathematics, particularly number theory, and Jean Bourgain from whom I have learned much of what I know about arithmetic combinatorics. I also learned a lot from my ongoing

collaboration with Gregory Margulis. I am grateful to the Clay Mathematics Institute for providing generous support at a crucial time. I am also grateful to Manfred Einsiedler and Michael Larsen for going over these notes at short notice, giving constructive and helpful comments. Last, but certainly not least, I want to thank my family — my wife Abigail, my daughters, my parents, and my sisters for too many things to list here.

References

- [APR83] L. M. Adleman, C. Pomerance, and R. S. Rumely, *On distinguishing prime numbers from composite numbers*, Ann. of Math. (2) **117** (1983), no. 1, 173–206. MR683806 (84e:10008)
- [Art24] E. Artin, *Ein mechanisches System mit quasiergodischen Bahnen*, Abhandlungen des Mathematischen Seminars **3** (1924), 170–175.
- [BQ09] Y. Benoist and J.-F. Quint, *Mesures stationnaires et fermés invariants des espaces homogènes* (2009). Preprint.
- [Ber84] D. Berend, *Multi-invariant sets on compact abelian groups*, Trans. Amer. Math. Soc. **286** (1984), no. 2, 505–535. MR760973 (86e:22009)
- [Bou09] J. Bourgain, *On the distribution of the residues of small multiplicative subgroups of \mathbb{F}_p* , Israel J. Math. **172** (2009), 61–74. MR2534239
- [Bou10] J. Bourgain, *The discretized sum product and projection theorems*, J. Anal. Math. (2010). To appear.
- [BL03] J. Bourgain and E. Lindenstrauss, *Entropy of quantum limits*, Comm. Math. Phys. **233** (2003), no. 1, 153–171. MR1957735 (2004c:11076)
- [BFLM10] J. Bourgain, A. Furman, E. Lindenstrauss, and S. Mozes, *Stationary measures and equidistribution for orbits of non-abelian semigroups on the torus*, J. Amer. Math. Soc. (2010). To appear.
- [BLMV09] J. Bourgain, E. Lindenstrauss, P. Michel, and A. Venkatesh, *Some effective results for $\times a \times b$* , Ergodic Theory Dynam. Systems **29** (2009), no. 6, 1705–1722. MR2563089
- [BGK06] J. Bourgain, A. A. Glibichuk, and S. V. Konyagin, *Estimates for the number of sums and products and for exponential sums in fields of prime order*, J. London Math. Soc. (2) **73** (2006), no. 2, 380–398. MR2225493 (2007e:11092)
- [BV10] J. Bourgain and P. P. Varjú, *Expansion in $\mathrm{SL}_d(\mathbb{Z}/q\mathbb{Z})$, q arbitrary* (2010), available at [arXiv:1006.3365](https://arxiv.org/abs/1006.3365).
- [BL10] S. Brooks and E. Lindenstrauss, *Graph Eigenfunctions and Quantum Unique Ergodicity* (2010).
- [BCZ03] Y. Bugeaud, P. Corvaja, and U. Zannier, *An upper bound for the G.C.D. of $a^n - 1$ and $b^n - 1$* , Math. Z. **243** (2003), no. 1, 79–84. MR1953049 (2004a:11064)
- [Bur90] M. Burger, *Horocycle flow on geometrically finite surfaces*, Duke Math. J. **61** (1990), no. 3, 779–803. MR1084459 (91k:58102)
- [Cas52] J. W. S. Cassels, *The product of n inhomogeneous linear forms in n variables*, J. London Math. Soc. **27** (1952), 485–492. MR0050632 (14,358d)
- [CSD55] J. W. S. Cassels and H. P. F. Swinnerton-Dyer, *On the product of three homogeneous linear forms and the indefinite ternary quadratic forms*, Philos. Trans. Roy. Soc. London. Ser. A. **248** (1955), 73–96. MR0070653 (17,14f)

- [Dan81] S. G. Dani, *Invariant measures and minimal sets of horospherical flows*, Invent. Math. **64** (1981), no. 2, 357–385. MR629475 (83c:22009)
- [Dan86] S. G. Dani, *On orbits of unipotent flows on homogeneous spaces. II*, Ergodic Theory Dynam. Systems **6** (1986), no. 2, 167–182. MR857195 (88e:58052)
- [Dan94] S. G. Dani, *A proof of Margulis' theorem on values of quadratic forms, independent of the axiom of choice*, Enseign. Math. (2) **40** (1994), no. 1-2, 49–58. MR1279060 (95e:11075)
- [DM90a] S. G. Dani and G. A. Margulis, *Values of quadratic forms at integral points: an elementary approach*, Enseign. Math. (2) **36** (1990), no. 1-2, 143–174. MR1071418 (91k:11053)
- [DM90b] S. G. Dani and G. A. Margulis, *Orbit closures of generic unipotent flows on homogeneous spaces of $SL(3, \mathbf{R})$* , Math. Ann. **286** (1990), no. 1-3, 101–128. MR1032925 (91k:22026)
- [DM93] S. G. Dani and G. A. Margulis, *Limit distributions of orbits of unipotent flows and values of quadratic forms*, I. M. Gel'fand Seminar, Adv. Soviet Math., vol. 16, Amer. Math. Soc., Providence, RI, 1993, pp. 91–137. MR1237827 (95b:22024)
- [DH46] H. Davenport and H. Heilbronn, *On indefinite quadratic forms in five variables*, J. London Math. Soc. **21** (1946), 185–193. MR0020578 (8,565e)
- [Duk88] W. Duke, *Hyperbolic distribution problems and half-integral weight Maass forms*, Invent. Math. **92** (1988), no. 1, 73–90. MR931205 (89d:11033)
- [Ein10] M. Einsiedler, *Applications of measure rigidity of diagonal actions*, International Congress of Mathematicians (Hyderabad, India, 2010), 2010.
- [EK03] M. Einsiedler and A. Katok, *Invariant measures on G/Γ for split simple Lie groups G* , Comm. Pure Appl. Math. **56** (2003), no. 8, 1184–1221. MR1989231 (2004e:37042)
- [EK05] M. Einsiedler and A. Katok, *Rigidity of measures—the high entropy case and non-commuting foliations*, Israel J. Math. **148** (2005), 169–238. Probability in mathematics. MR2191228 (2007d:37034)
- [EKL06] M. Einsiedler, A. Katok, and E. Lindenstrauss, *Invariant measures and the set of exceptions to Littlewood's conjecture*, Ann. of Math. (2) **164** (2006), no. 2, 513–560. MR2247967 (2007j:22032)
- [EL06] M. Einsiedler and E. Lindenstrauss, *Diagonalizable flows on locally homogeneous spaces and number theory*, International Congress of Mathematicians. Vol. II, Eur. Math. Soc., Zürich, 2006, pp. 1731–1759. MR2275667 (2009d:37007)
- [EL08] M. Einsiedler and E. Lindenstrauss, *On measures invariant under diagonalizable actions: the rank-one case and the general low-entropy method*, J. Mod. Dyn. **2** (2008), no. 1, 83–128. MR2366231 (2009h:37057)
- [EL10] M. Einsiedler and E. Lindenstrauss, *Diagonal actions on locally homogeneous spaces*, Proceedings of the 2007 Clay Summer School on Homogeneous Flows, Moduli Spaces and Arithmetic, Amer. Math. Soc., Providence, RI, 2010. To appear.
- [ELMV09] M. Einsiedler, E. Lindenstrauss, P. Michel, and A. Venkatesh, *Distribution of periodic torus orbits on homogeneous spaces*, Duke Math. J. **148** (2009), no. 1, 119–174. MR2515103
- [ELMV10] M. Einsiedler, E. Lindenstrauss, P. Michel, and A. Venkatesh, *Distribution of periodic torus orbits and Duke's theorem for cubic fields* (2010). to appear, Annals of Math.
- [EMV09] M. Einsiedler, G. A. Margulis, and A. Venkatesh, *Effective equidistribution for closed orbits of semisimple groups on homogeneous spaces*, Invent. Math. **177** (2009), no. 1, 137–212. MR2507639

- [EM04] N. D. Elkies and C. T. McMullen, *Gaps in $\sqrt{n} \bmod 1$ and ergodic theory*, Duke Math. J. **123** (2004), no. 1, 95–139. MR2060024 (2005f:11143)
- [EV08] J. S. Ellenberg and A. Venkatesh, *Local-global principles for representations of quadratic forms*, Invent. Math. **171** (2008), no. 2, 257–279. MR2367020 (2008m:11081)
- [EM04] A. Eskin and G. Margulis, *Recurrence properties of random walks on finite volume homogeneous manifolds*, Random walks and geometry, Walter de Gruyter GmbH & Co. KG, Berlin, 2004, pp. 431–444. MR2087794 (2005m:22025)
- [Fur67] H. Furstenberg, *Disjointness in ergodic theory, minimal sets, and a problem in Diophantine approximation*, Math. Systems Theory **1** (1967), 1–49. MR0213508 (35 #4369)
- [EMS96] A. Eskin, S. Mozes, and N. Shah, *Unipotent flows and counting lattice points on homogeneous varieties*, Ann. of Math. (2) **143** (1996), no. 2, 253–299, DOI 10.2307/2118644. MR1381987 (97d:22012)
- [Fur98] H. Furstenberg, *Stiffness of group actions*, Lie groups and ergodic theory (Mumbai, 1996), Tata Inst. Fund. Res. Stud. Math., vol. 14, Tata Inst. Fund. Res., Bombay, 1998, pp. 105–117. MR1699360 (2000f:22008)
- [GM10] F. Götze and G. Margulis, *Distribution of Values of Quadratic Forms at Integral Points* (Apr. 2010), available at [arXiv:1004.5123](https://arxiv.org/abs/1004.5123).
- [GT07] B. Green and T. Tao, *The quantitative behaviour of polynomial orbits on nilmanifolds*, Annals of Math. (2007), available at [arxiv:0709.3562](https://arxiv.org/abs/0709.3562). To appear.
- [GS04] Y. Guivarc’h and A. N. Starkov, *Orbits of linear group actions, random walks on homogeneous spaces and toral automorphisms*, Ergodic Theory Dynam. Systems **24** (2004), no. 3, 767–802. MR2060998 (2005f:37058)
- [HS09] R. Holowinsky and K. Soundararajan, *Mass equidistribution of Hecke eigenforms* (2009), available at [arxiv:0809.1636](https://arxiv.org/abs/0809.1636).
- [KS96] A. Katok and R. J. Spatzier, *Invariant measures for higher-rank hyperbolic abelian actions*, Ergodic Theory Dynam. Systems **16** (1996), no. 4, 751–778. MR1406432 (97d:58116)
- [Lin01] E. Lindenstrauss, *Pointwise theorems for amenable groups*, Invent. Math. **146** (2001), no. 2, 259–295. MR1865397 (2002h:37005)
- [Lin06] E. Lindenstrauss, *Invariant measures and arithmetic quantum unique ergodicity*, Ann. of Math. (2) **163** (2006), no. 1, 165–219. MR2195133 (2007b:11072)
- [LS10] E. Lindenstrauss and U. Shapira, *Homogeneous orbit closures and applications* (2010). Preprint.
- [LW01] E. Lindenstrauss and Barak Weiss, *On sets invariant under the action of the diagonal group*, Ergodic Theory Dynam. Systems **21** (2001), no. 5, 1481–1500. MR1855843 (2002j:22009)
- [Li68] Yu. V. Linnik, *Ergodic properties of algebraic fields*, Translated from the Russian by M. S. Keane. Ergebnisse der Mathematik und ihrer Grenzgebiete, Band 45, Springer-Verlag New York Inc., New York, 1968. MR0238801 (39 #165)
- [Lyo88] R. Lyons, *On measures simultaneously 2- and 3-invariant*, Israel J. Math. **61** (1988), no. 2, 219–224. MR941238 (89e:28031)
- [Mar71] G. A. Margulis, *The action of unipotent groups in a lattice space*, Mat. Sb. (N.S.) **86(128)** (1971), 552–556 (Russian). MR0291352 (45 #445)
- [Mar87] G. A. Margulis, *Formes quadratiques indéfinies et flots unipotents sur les espaces homogènes*, C. R. Acad. Sci. Paris Sér. I Math. **304** (1987), no. 10, 249–253 (English, with French summary). MR882782 (88f:11027)

- [Mar97] G. A. Margulis, *Oppenheim conjecture*, Fields Medallists' lectures, World Sci. Ser. 20th Century Math., vol. 5, World Sci. Publ., River Edge, NJ, 1997, pp. 272–327. MR1622909 (99e:11046)
- [Mar00] G. A. Margulis, *Problems and conjectures in rigidity theory*, Mathematics: frontiers and perspectives, Amer. Math. Soc., Providence, RI, 2000, pp. 161–174. MR1754775 (2001d:22008)
- [MT94] G. A. Margulis and G. M. Tomanov, *Invariant measures for actions of unipotent groups over local fields on homogeneous spaces*, Invent. Math. **116** (1994), no. 1-3, 347–392. MR1253197 (95k:22013)
- [Mau10] F. Maucourant, *A non-homogeneous orbit closure of a diagonal subgroup*, Ann. of Math. **171** (2010), no. 1, 557–570.
- [MV06] Ph. Michel and A. Venkatesh, *Equidistribution, L-functions and ergodic theory: on some problems of Yu. Linnik*, International Congress of Mathematicians. Vol. II, Eur. Math. Soc., Zürich, 2006, pp. 421–457. MR2275604 (2008g:11085)
- [MV09] Ph. Michel and A. Venkatesh, *The subconvexity problem for GL_2* , Publ. IHES (2009), available at [arxiv:0903.3591](https://arxiv.org/abs/0903.3591). To appear.
- [MS95] S. Mozes and N. Shah, *On the space of ergodic invariant measures of unipotent flows*, Ergodic Theory Dynam. Systems **15** (1995), no. 1, 149–159. MR1314973 (95k:58096)
- [Muc05] R. Muchnik, *Semigroup actions on \mathbb{T}^n* , Geom. Dedicata **110** (2005), 1–47. MR2136018 (2006i:37022)
- [Oh10] H. Oh, *Orbital counting via mixing and unipotent flows*, Proceedings of the 2007 Clay Summer School on Homogeneous Flows, Moduli Spaces and Arithmetic, Amer. Math. Soc., Providence, RI, 2010. To appear.
- [Ra82a] M. Ratner, *Rigidity of horocycle flows*, Ann. of Math. (2) **115** (1982), no. 3, 597–614. MR657240 (84e:58062)
- [Ra82b] M. Ratner, *Factors of horocycle flows*, Ergodic Theory Dynam. Systems **2** (1982), no. 3-4, 465–489 (1983). MR721735 (86a:58076)
- [Ra83] M. Ratner, *Horocycle flows, joinings and rigidity of products*, Ann. of Math. (2) **118** (1983), no. 2, 277–313. MR717825 (85k:58063)
- [Ra90a] M. Ratner, *On measure rigidity of unipotent subgroups of semisimple groups*, Acta Math. **165** (1990), no. 3-4, 229–309. MR1075042 (91m:57031)
- [Ra90b] M. Ratner, *Strict measure rigidity for unipotent subgroups of solvable groups*, Invent. Math. **101** (1990), no. 2, 449–482. MR1062971 (92h:22015)
- [Ra91a] M. Ratner, *On Raghunathan's measure conjecture*, Ann. of Math. (2) **134** (1991), no. 3, 545–607. MR1135878 (93a:22009)
- [Ra91b] M. Ratner, *Raghunathan's topological conjecture and distributions of unipotent flows*, Duke Math. J. **63** (1991), no. 1, 235–280. MR1106945 (93f:22012)
- [Ra95] M. Ratner, *Raghunathan's conjectures for Cartesian products of real and p -adic Lie groups*, Duke Math. J. **77** (1995), no. 2, 275–382. MR1321062 (96d:22015)
- [Ree82] M. Rees, *Some R^2 -anosov flows*, 1982. unpublished.
- [RS94] Z. Rudnick and P. Sarnak, *The behaviour of eigenstates of arithmetic hyperbolic manifolds*, Comm. Math. Phys. **161** (1994), no. 1, 195–213. MR1266075 (95m:11052)
- [Rud90] D. J. Rudolph, *$\times 2$ and $\times 3$ invariant measures and entropy*, Ergodic Theory Dynam. Systems **10** (1990), no. 2, 395–406. MR1062766 (91g:28026)
- [SS08] O. Sarig and B. Schapira, *The generic points for the horocycle flow on a class of hyperbolic surfaces with infinite genus*, Int. Math. Res. Not. IMRN (2008), Art. ID rnn 086, 37. MR2439545 (2009k:37075)

- [Sar81] P. Sarnak, *Asymptotic behavior of periodic orbits of the horocycle flow and Eisenstein series*, Comm. Pure Appl. Math. **34** (1981), no. 6, 719–739. MR634284 (83m:58060)
- [Sch80] W. M. Schmidt, *Diophantine approximation*, Lecture Notes in Mathematics, vol. 785, Springer, Berlin, 1980. MR568710 (81j:10038)
- [Ser85] C. Series, *The modular surface and continued fractions*, J. London Math. Soc. (2) **31** (1985), no. 1, 69–80. MR810563 (87c:58094)
- [Sh98] N. A. Shah, *Invariant measures and orbit closures on homogeneous spaces for actions of subgroups generated by unipotent elements*, Lie groups and ergodic theory (Mumbai, 1996), Tata Inst. Fund. Res. Stud. Math., vol. 14, Tata Inst. Fund. Res., Bombay, 1998, pp. 229–271. MR1699367 (2001a:22012)
- [Sha10] U. Shapira, *A solution to a problem of Cassels and Diophantine properties of cubic numbers*, Ann. of Math. (2010). To appear.
- [Sou09] K. Soundararajan, *Quantum unique ergodicity for $SL_2(\mathbb{Z}) \backslash \mathbb{H}$* (2009), available at [arxiv:0901.4060](https://arxiv.org/abs/0901.4060).
- [Sou10] K. Soundararajan, *Quantum unique ergodicity and number theory*, International Congress of Mathematicians (Hyderabad, India, 2010), 2010.
- [Vat02] V. Vatsal, *Uniform distribution of Heegner points*, Invent. Math. **148** (2002), no. 1, 1–46. MR1892842 (2003j:11070)
- [Ven05] A. Venkatesh, *Sparse equidistribution problems, period bounds, and subconvexity*, Annals of Math. (2005), available at [arXiv:math/0506224](https://arxiv.org/abs/math/0506224). To appear.
- [Wan10] Z. Wang, *Quantitative Density under Higher Rank Abelian Algebraic Toral Actions* (2010). Submitted.

Cluster Categories

Idun Reiten*

Abstract

Cluster algebras were introduced by Fomin-Zelevinsky in 2002 in order to give a combinatorial framework for phenomena occurring in the context of algebraic groups. Cluster algebras also have links to a wide range of other subjects, including the representation theory of finite dimensional algebras, as first discovered by Marsh- Reineke-Zelevinsky. Modifying module categories over hereditary algebras, cluster categories were introduced in work with Buan-Marsh-Reineke-Todorov in order to “categorify” the essential ingredients in the definition of cluster algebras in the acyclic case. They were shown to be triangulated by Keller. Related work was done by Geiss-Leclerc-Schröer using preprojective algebras of Dynkin type. In work by many authors there have been further developments, leading to feedback to cluster algebras, new interesting classes of finite dimensional algebras, and the investigation of categories of Calabi-Yau dimension 2.

Mathematics Subject Classification (2010). Primary 16G20, 13F60, 18E30; Secondary 16D90, 16G70, 05E10.

Keywords. quivers, path algebras, cluster algebras, cluster categories, Calabi-Yau categories, derived categories, tilting modules, almost split sequences

Introduction

Almost 10 years ago Fomin and Zelevinsky introduced the concept of cluster algebras, in order to create a combinatorial framework for the study of canonical bases in quantum groups, and for the study of total positivity for algebraic groups. In a series of papers they developed a theory of cluster algebras, which has turned out to have numerous applications to many areas of mathematics. One of the most important and influential connections has been with the representation theory of finite dimensional algebras. Such a connection was suggested by the paper [92].

*Norwegian University of Science and Technology, NTNU, Sentralbygg 2, Alfred Getz vei 1, 7491 Trondheim, Norway. E-mail: idunr@math.ntnu.no

A cluster algebra, in its simplest form, is defined as follows, as a subalgebra of the rational function field $F = \mathbb{Q}(x_1, \dots, x_n)$. Start with a *seed* $((x_1, \dots, x_n), B)$, which, by definition, is a pair consisting of a free generating set of F , which for simplicity we choose to be (x_1, \dots, x_n) , and a skew symmetric $n \times n$ matrix B over \mathbb{Z} . Alternatively, we can instead of the matrix use a finite quiver Q (that is, directed graph) with vertices $1, 2, \dots, n$, and no oriented cycles of length 1 or 2. For each $i = 1, \dots, n$, a new seed $\mu_i((x_1, \dots, x_n), Q)$ is defined by first replacing x_i with another element x_i^* in F according to a specific rule which depends upon both (x_1, \dots, x_n) and Q . Then we get a new free generating set $(x_1, \dots, x_{i-1}, x_i^*, x_{i+1}, \dots, x_n)$. For $i = 1, \dots, n$ there is defined a *mutation* $\mu_i(Q)$ of the quiver Q , giving a new quiver with n vertices. Then we get a new seed $((x_1, \dots, x_{i-1}, x_i^*, x_{i+1}, \dots, x_n), \mu_i(Q))$. We continue applying μ_1, \dots, μ_n to the new seeds to get further seeds. The n -element subsets occurring in seeds are called *clusters*, and the elements in the clusters are called *cluster variables*. The associated *cluster algebra* is the subalgebra of F generated by all cluster variables.

There are many challenging problems concerning cluster algebras. One way of attacking them is via *categorification*. This is not a well defined procedure, but expresses the philosophy that we want to replace ingredients in the definition of cluster algebras by similar concepts in a category with additional structure. The category could for example be the category of finite dimensional modules over a finite dimensional k -algebra for a field k , or a closely related category with similar properties. In particular, the category should have enough structure so that each object X has an associated finite quiver Q_X (namely the quiver of the endomorphism algebra of the object). It is an extra bonus if there is a way of constructing the original ingredients of the cluster algebra back from the chosen analogous object in the new category, but we do not require that this should always be the case.

We first discuss the special case of categorifying quiver mutation alone. Then we want to find a “nice” category \mathcal{C} with a distinguished set \mathcal{T} of objects, with an operation $T \mapsto \mu_i(T)$ defined for T in \mathcal{T} and any $i = 1, \dots, n$. We would like this operation to “lift” the quiver mutation, that is, we would want that $Q_T = Q$ and $Q_{\mu_i(T)} = \mu_i(Q)$.

We then discuss categorification of some of the essential ingredients involved in the definition of cluster algebras, such as clusters, cluster variables, seeds. We want to imitate these concepts, and preferably also operations of addition and multiplication involving them, in a “nice” category \mathcal{C} . As analogs of clusters we want a distinguished set \mathcal{T} of objects of the form $T = T_1 \oplus \dots \oplus T_n$, where the T_i are indecomposable and $T_i \neq T_j$ for $i \neq j$. The T_i would then be the analogs of cluster variables. For each $i = 1, \dots, n$ we want a unique indecomposable object $T_i^* \neq T_i$, where T_i^* is a summand of an object in \mathcal{T} , such that $T/T_i \oplus T_i^*$ is in \mathcal{T} . To find analogs of the seeds, we consider pairs (T, Q) where T is in \mathcal{T} and Q is a quiver with n vertices. For a seed $((u_1, \dots, u_n), Q)$ it does not make sense to talk about a connection between (u_1, \dots, u_n) and Q . But

for the pair (T, Q) a natural connection to ask for between T and Q is that Q coincides with the quiver Q_T of the endomorphism algebra $\text{End}(T)^{\text{op}}$. We can try to choose T such that we have an *initial tilting seed* (T, Q) with this property. If the same set \mathcal{T} provides a categorification of quiver mutation in the sense discussed above, then this nice property for a tilting seed will hold for all pairs obtained from (T, Q) via a sequence of mutations of the objects in \mathcal{T} .

We have collected a (not complete) list of desired properties for the categories, together with a distinguished set of objects \mathcal{T} , which we would like our categorification to satisfy. But there is of course no guarantee to start with that it is possible to find a satisfactory solution. Here we explain how we can find an appropriate categorification in the case of what is called acyclic cluster algebras. We let Q be an acyclic quiver, that is, a quiver with no oriented cycles, with n vertices. Given a field k , there is a way of associating a finite dimensional path algebra kQ with the quiver Q (see Section 1). Then the category of finite dimensional kQ -modules might be a candidate for the category we are looking for. The tilting modules, which have played a central role in the representation theory of finite dimensional algebras, might be a candidate for the distinguished set of objects, since they have some of the desired properties, as also suggested by the work in [92]. A kQ -module $T = T_1 \oplus \dots \oplus T_n$ is a *tilting* module if the T_i are indecomposable, $T_i \neq T_j$ for $i \neq j$, and every exact sequence of the form $0 \rightarrow T \rightarrow E \rightarrow T \rightarrow 0$ splits. However, this choice does not quite work since it may happen that for some i there is no indecomposable module $T_i^* \neq T_i$ such that $T/T_i \oplus T_i^*$ is a tilting module. The idea is then to “enlarge” the category $\text{mod } kQ$ to make it more likely to find some T_i^* . This enlargement can in practice be done by taking a much larger category containing $\text{mod } kQ$, namely the bounded derived category $\mathcal{D}^b(kQ)$, and then taking the orbit category under the action of a suitable cyclic group in order to cut down the size. Then we end up with what has been called the *cluster category* \mathcal{C}_Q [20]. As distinguished set of objects \mathcal{T} we choose an enlargement of the set of tilting kQ -modules, called *cluster tilting* objects. Then \mathcal{C}_Q , together with \mathcal{T} , has all the properties we asked for above, and some more which we did not list.

It is natural to try to find other categories with distinguished sets of objects which would categorify other classes of cluster algebras. This has been successfully done in [57] using the category of finite dimensional modules $\text{mod } \Lambda$ over a class of finite dimensional algebras Λ called preprojective algebras of Dynkin type.

The investigation of cluster categories and preprojective algebras of Dynkin type has further led to work on what is called Hom-finite triangulated 2-Calabi-Yau categories (2-CY for short), with a specific set of objects called cluster tilting objects [78]. The endomorphism algebras of the cluster tilting objects form an interesting class of finite dimensional algebras. For example, the investigation of the cluster tilted algebras, which by definition are those coming from cluster categories, has shed new light on tilting theory.

In addition, there have been exciting applications of the categorification to the theory of cluster algebras. For this it is useful to establish a tighter connection between cluster algebras and cluster categories (or more general 2-CY categories). This can happen through providing maps in one or both directions, especially between the cluster variables and the indecomposable summands of the cluster tilting objects. In many cases, for example for cluster categories, such explicit maps have been constructed, giving deep connections which are useful for applications to cluster algebras ([25],[31],[35],[34],[57],[95]).

A special case of the problem of categorifying quiver mutation was investigated in the early days of the present form of the representation theory of finite dimensional algebras, which started around 40 years ago. Reflections of quivers at vertices which are sinks (or sources) were introduced in [15]. A *sink* i is a vertex where no arrow starts, and a *source* is a vertex where no arrow ends. The operation μ_i on a quiver where i is a sink was defined by reversing all arrows ending at i . A categorification of this special case of quiver mutation was done using tilting modules over the path algebras kQ for a finite acyclic quiver Q [8]. In this special case it was possible to use tilting modules [8].

We start the paper with a discussion of this mutation from [15] and its categorification in Section 1. We also give some definitions and basic properties of path algebras and quiver representations. In Section 2 we give an introduction to the theory of cluster algebras, including definitions, examples and crucial properties. Cluster categories are introduced in Section 3. We give some motivation, including a list of desired properties which they should satisfy, and illustrate through examples. We also introduce the cluster tilting objects. In Section 4 we deal with generalizations to Hom-finite triangulated 2-CY categories. The endomorphism algebras of cluster tilting objects are called 2-CY-tilted algebras. They are discussed in Section 5, together with their relationship to the interesting class of Jacobian algebras, which are given by quivers with potential [39]. In Section 6 we discuss applications to cluster algebras in the acyclic case.

The various aspects of the relationship between cluster algebras and the representation theory of finite dimensional algebras have stimulated a lot of research activity during the last few years, with several interesting developments by a large number of contributors. I have chosen to emphasize aspects closest to my own interest, which deal with the more categorical aspects of the subject. But cluster algebras lie in the center of it all, as inspiration, so I have included a brief discussion of them, as well as a discussion of the feedback of the general categorical approach to cluster algebras.

Several important topics related to cluster algebras are not discussed in this paper. In particular, this concerns the developments dealing with the cluster algebras themselves, the applications of categorification to the construction of (semi)canonical bases and their duals [57], and the recent work in [89] related to 3-Calabi-Yau algebras. Another interesting type of categorification was

introduced in [70], and pursued in [94], see also [91]. We also refer to [40] for work using quivers with potentials to solve a series of conjectures.

We refer to the survey papers ([19],[45],[80],[81],[82],[83],[91],[99],[100],[104],[112]) for additional information.

1. Bernstein-Gelfand-Ponomarev Reflections

In this section we go back to the beginning of the present form of the representation theory of finite dimensional algebras, which dates back to around 1970. We show that some of the early developments can be seen as categorification of Bernstein-Gelfand-Ponomarev reflections of quivers at sinks (or sources), which is a special case of the quiver mutation used by Fomin-Zelevinsky in connection with their definition of cluster algebras. This categorification involves tilting theory ([16],[67]), which is one of the most important developments in the representation theory of algebras. There are numerous applications both within the field and outside. We start with some relevant background material. We refer to the books ([6],[10],[54],[64],[103]) as general references.

1.1. Representations of quivers. Let Q be a *finite quiver*, that is, a directed graph with a finite number of vertices and a finite number of arrows between the vertices. Assume that the quiver Q is *acyclic*, that is, has no oriented cycles; for example, let Q be the quiver $1 \xrightarrow{\alpha} 2 \xrightarrow{\beta} 3$. For simplicity of exposition, we define the most relevant concepts only for this example.

Let k be a field, which we always assume to be algebraically closed. A representation of Q over k is $V_1 \xrightarrow{f_\alpha} V_2 \xrightarrow{f_\beta} V_3$, where we have associated a finite dimensional vector space V_i to each vertex i , and a linear transformation to each arrow. A map

$$h : (V_1 \xrightarrow{f_\alpha} V_2 \xrightarrow{f_\beta} V_3) \longrightarrow (V'_1 \xrightarrow{f'_\alpha} V'_2 \xrightarrow{f'_\beta} V'_3)$$

between two representations is a triple $h = (h_1, h_2, h_3)$, where $h_i : V_i \rightarrow V'_i$ is a linear transformation for each i , such that the following diagram commutes.

$$\begin{array}{ccccc} V_1 & \xrightarrow{f_\alpha} & V_2 & \xrightarrow{f_\beta} & V_3 \\ \downarrow h_1 & & \downarrow h_2 & & \downarrow h_3 \\ V'_1 & \xrightarrow{f'_\alpha} & V'_2 & \xrightarrow{f'_\beta} & V'_3 \end{array}$$

The category $\text{rep } Q$ of representations of Q , with objects and maps as defined above, is equivalent to the category $\text{mod } kQ$ of finite dimensional modules over the path algebra kQ . Here the paths in Q , including the trivial paths e_i associated with the vertices i , are a k -basis for kQ . So in our example $\{\alpha, \beta, \beta\alpha, e_1, e_2, e_3\}$ is a k -basis. The multiplication for the basis elements is defined as composition of paths whenever this is possible, and is defined to

be 0 otherwise. For example, we have $\beta \cdot \alpha = \beta\alpha$, $\alpha \cdot e_2 = 0$, $\alpha \cdot e_1 = \alpha$, $e_1 \cdot e_1 = e_1$.

The connection between $\text{rep } Q$ and $\text{mod } kQ$ is illustrated as follows. If $V_1 \xrightarrow{f_\alpha} V_2 \xrightarrow{f_\beta} V_3$ is in $\text{rep } Q$, then the vector space $V_1 \oplus V_2 \oplus V_3$ can be given a kQ -module structure by defining $\alpha(v_1, v_2, v_3) = (0, f_\alpha(v_1), 0)$, $\beta(v_1, v_2, v_3) = (0, 0, f_\beta(v_2))$, $e_1(v_1, v_2, v_3) = (v_1, 0, 0)$, $e_2(v_1, v_2, v_3) = (0, v_2, 0)$, $e_3(v_1, v_2, v_3) = (0, 0, v_3)$.

The indecomposable projective representations P_1, P_2 and P_3 associated with the vertices 1, 2 and 3 are $k \xrightarrow{id} k \xrightarrow{id} k$, $0 \rightarrow k \xrightarrow{id} k$ and $0 \rightarrow 0 \rightarrow k$, the simple representations S_1, S_2 and S_3 are $k \rightarrow 0 \rightarrow 0$, $0 \rightarrow k \rightarrow 0$ and $0 \rightarrow 0 \rightarrow k$ and the indecomposable injective representations I_1, I_2 and I_3 are $k \rightarrow 0 \rightarrow 0$, $k \xrightarrow{id} k \rightarrow 0$ and $k \xrightarrow{id} k \xrightarrow{id} k$. We also use the same notation for a representation viewed as a kQ -module.

An important early result on quiver representations was the following [53].

Theorem 1.1. *Let Q be a finite connected quiver and k an algebraically closed field. Then $\text{rep } Q$ has only a finite number of indecomposable representations up to isomorphism if and only if the underlying graph $|Q|$ is of Dynkin type A_n, D_n, E_6, E_7 or E_8 .*

1.2. Reflection functors. The proof by Gabriel of Theorem 1.1 was technically complicated. A more elegant proof was soon thereafter given by Bernstein-Gelfand-Ponomarev [15], taking advantage of the fact that the classification theorem involved Dynkin diagrams, a fact which suggested connections with root systems and positive definite quadratic forms. One important aspect of their work was that they introduced reflections of quivers and associated reflection functors. Using this, together with some special modules from [8] inspired by the reflection functors, later known as APR-tilting modules, we shall illustrate the idea of categorification. These examples are special cases of categorifications of more general mutation of quivers, which is important for the categorification of cluster algebras.

Let i be a vertex in the quiver Q which is a sink, that is, there are no arrows starting at i . In our running example the vertex 3 is a sink. We define a new quiver $\mu_3(Q)$, known as the *mutation* of Q at the vertex 3. This is obtained by reversing all the arrows in Q ending at 3, so in our example it is the quiver $1 \longrightarrow 2 \longleftarrow 3$. In [15] a reflection functor $F_3 : \text{rep } Q \rightarrow \text{rep } Q'$ was defined on objects by sending $V_1 \xrightarrow{f_\alpha} V_2 \xrightarrow{f_\beta} V_3$ to $V_1 \xrightarrow{f_\alpha} V_2 \xleftarrow{f'_\beta} \text{Ker } f_\beta$, where f'_β is the natural inclusion. We see that S_3 is sent to the zero representation, and we have the following connection between $\text{rep } Q$ and $\text{rep } Q'$, where S'_3 is the representation $0 \rightarrow 0 \leftarrow k$ of Q' .

Theorem 1.2. *The reflection functor F_3 induces an equivalence $F_3 : \text{rep } Q \setminus S_3 \rightarrow \text{rep } Q' \setminus S'_3$, where $\text{rep } Q \setminus S_3$ denotes the full subcategory of $\text{rep } Q$*

consisting of objects which are finite direct sums of indecomposable objects not isomorphic to S_3 .

This is a key step in the proof in [15] of Gabriel’s theorem. It gives an easy illustration of a categorification, where a quiver Q is replaced by some object in $\text{rep } Q$, and the mutation of Q at a sink i is replaced by the associated functor F_i .

1.3. Illustration using AR-quiver. For a finite dimensional k -algebra Λ a special kind of exact sequence, known as an *almost split sequence* (or also *Auslander-Reiten sequence*), was introduced in [9]. An exact sequence $0 \rightarrow A \xrightarrow{f} B \xrightarrow{g} C \rightarrow 0$ is almost split if it is not split, the end terms are indecomposable, and each map $h : X \rightarrow C$ where X is indecomposable and h is not an isomorphism, factors through $g : B \rightarrow C$. We have the following basic result, where we assume that all our modules are finite dimensional over k [9].

Theorem 1.3. *For any indecomposable nonprojective Λ -module C (or for any indecomposable noninjective Λ -module A), there exists an almost split sequence $0 \rightarrow A \rightarrow B \rightarrow C \rightarrow 0$, which is unique up to isomorphism.*

The almost split sequences induce an operation τ , called the AR-translation, from the indecomposable nonprojective Λ -modules to the indecomposable noninjective ones, satisfying $\tau(C) = A$ when $0 \rightarrow A \rightarrow B \rightarrow C \rightarrow 0$ is almost split.

On the basis of the information given by the almost split sequences (in general together with some special maps to projectives and from injectives) we can draw a new quiver, called the *Auslander-Reiten quiver* (AR-quiver for short), where the vertices correspond to the isomorphism classes of indecomposable Λ -modules.

In our examples we have the following.

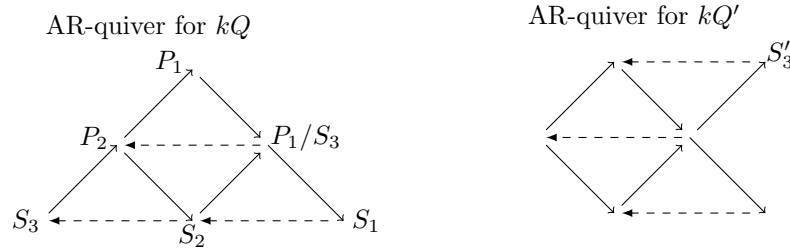

The broken arrows indicate the translation τ , and we can then deduce the shape of the almost split sequences from the AR-quiver. For example, for kQ we have the almost split sequences $0 \rightarrow S_3 \rightarrow P_2 \rightarrow S_2 \rightarrow 0$, $0 \rightarrow S_2 \rightarrow P_1/S_3 \rightarrow S_1 \rightarrow 0$ and $0 \rightarrow P_2 \rightarrow P_1 \oplus S_2 \rightarrow P_1/S_3 \rightarrow 0$. The AR-quivers for kQ and kQ' are not isomorphic, but when dropping S_3 from the first one and S'_3 from the second one, they are clearly isomorphic. This reflects the fact that

there is an equivalence between the corresponding subcategories, as stated in Theorem 1.2.

1.4. Module theoretical interpretation. Let Q be a finite quiver without oriented cycles and with vertices $1, \dots, n$. Let i be a vertex of Q which is a sink. Denote by $\mu_i(Q) = Q'$ the quiver obtained by mutation at i . We write $kQ = P_1 \oplus \dots \oplus P_n$, where P_j is the indecomposable projective kQ -module associated with the vertex j . Then we have the following module theoretical interpretation of the reflection functors [8].

Theorem 1.4. *With the above notation, we have the following.*

- (a) For $T = kQ/P_i \oplus \tau^{-1}P_i$ we have $\text{End}_{kQ}(T)^{\text{op}} \simeq kQ'$.
- (b) The functor $F_i : \text{rep } Q \rightarrow \text{rep } Q'$ is isomorphic to the functor $\text{Hom}_{kQ}(T, _): \text{mod } kQ \rightarrow \text{mod } kQ'$.

Let $J = J_Q$ be the ideal generated by all arrows in a path algebra kQ . It is known that any finite dimensional k -algebra A is Morita equivalent to kQ/I for some finite quiver Q and ideal I in kQ with $I \subseteq J^2$. A generating set of I is called a set of *relations* for A . We denote Q by Q_A . In particular, we have $Q_{kQ} = Q$ and $Q_{kQ'} = Q'$. If X is in $\text{mod } A$, then the associated quiver Q_X is by definition the quiver $Q_{\text{End}(X)^{\text{op}}}$ associated with the finite dimensional k -algebra $\text{End}(X)^{\text{op}}$.

In our running example we have $T = P_1 \oplus P_2 \oplus \tau^{-1}S_3$. Consider the diagram

$$\begin{array}{ccc} kQ & \xrightarrow{\quad} & T \\ \downarrow & & \downarrow \\ Q & \xrightarrow{\mu_3} & \mu_3(Q) = Q' \end{array}$$

Then $Q_T = Q'$ since $\text{End}_{kQ}(T)^{\text{op}} \simeq kQ'$. Further, we can define $\mu_3(kQ)$ by replacing $P_3 = S_3$ by $\tau^{-1}S_3$, so that $\mu_3(kQ) = T$. This way we can view the above theorem as a way of categorifying quiver mutation. This categorification, which is quite different from the one discussed in Section 1.2, is of the type we shall be dealing with, and it will be generalized later.

1.5. Tilting theory. The kQ -modules kQ and T are examples of what are now called tilting modules ([16], [67]). A module T over a path algebra kQ is a *tilting module* if $\text{Ext}_{kQ}^1(T, T) = 0$, and the number of nonisomorphic indecomposable summands is the number of vertices in the quiver Q . Objects X with $\text{Ext}_{kQ}^1(X, X) = 0$ are called *rigid*. The endomorphism algebras $\text{End}_{kQ}(T)^{\text{op}}$ are by definition the *tilted* algebras. It was the work discussed in Sections 1.2 and 1.4 which inspired tilting theory.

An aspect of tilting theory of interest in this paper is the following ([102],[110],[68]).

Theorem 1.5. *Let $T = T_1 \oplus \dots \oplus T_n$ be a tilting kQ -module, where the T_i are indecomposable and $T_i \neq T_j$ for $i \neq j$.*

- (a) *For each i , there is at most one indecomposable kQ -module $T_i^* \neq T_i$ such that $T/T_i \oplus T_i^*$ is a tilting kQ -module.*
- (b) *For each i there exists such a module T_i^* if and only if T/T_i is a sincere kQ -module, that is, all simple kQ -modules are composition factors of T/T_i .*

The modules T/T_i are called *almost complete* tilting modules, and T_i (and T_i^* if it exists) are called *complements* of T/T_i . The kQ -module kQ is clearly a tilting module, and when i is a sink in the quiver Q , then there is always some indecomposable kQ -module $P_i^* \neq P_i$ such that $kQ/P_i \oplus P_i^*$ is a tilting module. The module T_i^* is in fact $\tau^{-1}P_i$. So we can view the previously defined operation $\mu_i(kQ)$ as replacing P_i by the unique indecomposable kQ -module $P_i^* \neq P_i$ such that $kQ/P_i \oplus P_i^*$ is a tilting module.

1.6. General quiver mutation and tilting modules. For quivers with no loops \curvearrowright and no (oriented) 2-cycles \rightleftarrows , Fomin and Zelevinsky have introduced a mutation of quivers at any vertex of the quiver as follows [48] (see also papers in mathematical physics [107]).

Let i be a vertex in the quiver Q .

- (i) Each pair of arrows $s \rightarrow i \rightarrow t$ in Q gives rise to a new arrow $s \rightarrow t$ in the mutated quiver $\mu_i(Q)$.
- (ii) We reverse the arrows starting or ending at i .
- (iii) We remove any 2-cycles.

Example 1.6. Let Q be the quiver $1 \xrightarrow{\alpha} 2 \xrightarrow{\beta} 3$. Then $\mu_2(Q)$ is the quiver $1 \xleftarrow{\quad} 2 \xleftarrow{\quad} 3$. Let again $kQ = P_1 \oplus P_2 \oplus P_3$ be the tilting kQ -module associated with Q . Then $T = P_1 \oplus S_1 \oplus P_3$ is also a tilting kQ -module, and we define $\mu_2(kQ) = T$ according to the previous principle. But the quiver Q_T associated to T can be shown to be $1 \xleftarrow{\quad} 2 \xrightarrow{\quad} 3$. Hence mutation of tilting modules does not give a categorification of quiver mutation in this case. For the vertex 1, it is not even possible to replace P_1 to get another tilting module.

In conclusion, we can use tilting modules to categorify quiver mutation at sinks, but not at an arbitrary vertex. We shall see in Section 3 how we can modify the module category $\text{mod } kQ$, and use objects related to tilting

kQ -modules, in order to make things work for quiver mutation at any vertex of an acyclic quiver (and more generally any quiver in the mutation class of an acyclic quiver). We shall also see that in addition to being interesting in itself, this work can be used to obtain information on the mutation class of a finite acyclic quiver. Here we take advantage of the richer structure provided by the categorification. We shall also see that for another class of quivers one can actually use tilting modules to categorify quiver mutation [77].

2. Cluster Algebras

Cluster algebras were introduced by Fomin and Zelevinsky in [48]. The motivation was to create a common framework for phenomena occurring in connection with total positivity and canonical bases. The theory has had considerable influence on many different areas, amongst them the theory of quiver representations. In this section we give basic definitions and state some main results, following ([48],[49]), in order to have appropriate background for discussing categorification of cluster algebras.

2.1. Cluster algebras with no coefficients. We first discuss cluster algebras with “no coefficients,” which we mainly deal with in this paper. Let $F = \mathbb{Q}(x_1, \dots, x_n)$ be the function field in n variables over the field \mathbb{Q} of rational numbers, and let $B = (b_{ij})$ be an $n \times n$ - matrix. We assume for simplicity that B is skew symmetric. Then B corresponds to a quiver with n vertices, where there are b_{ij} arrows from i to j if $b_{ij} > 0$. Here we deal with quivers instead of matrices. We start with an *initial seed* $((x_1, \dots, x_n), Q)$, consisting of a free generating set (x_1, \dots, x_n) for F , together with a finite quiver Q with n vertices, labelled $1, \dots, n$. For each $i \in \{1, \dots, n\}$ we define a new seed $\mu_i((x_1, \dots, x_n), Q)$ to be a pair $((x_1, \dots, x_{i-1}, x_i^*, x_{i+1}, \dots, x_n), \mu_i(Q))$. Here x_i^* is defined by the equality $x_i x_i^* = m_1 + m_2$, where m_1 is the product whose terms are x_j^s if there are s arrows from j to i , and m_2 is the corresponding product associated with the arrows starting at i . If i is a source, that is, no arrow ends at i , we set $m_1 = 1$, and if i is a sink we set $m_2 = 1$. It can be shown that $(x_1, \dots, x_{i-1}, x_i^*, x_{i+1}, \dots, x_n)$ is again a free generating set, and that $\mu_i^2((x_1, \dots, x_n), Q) = ((x_1, \dots, x_n), Q)$. Note that the quiver $\mu_i(Q) = Q'$ only depends on the quiver Q , while the new free generating set depends on both Q and the old free generating set.

We illustrate with the following.

Example 2.1. Let $F = \mathbb{Q}(x_1, x_2, x_3)$ and Q be the quiver $1 \longrightarrow 2 \longrightarrow 3$. We start with the seed $((x_1, x_2, x_3), 1 \rightarrow 2 \rightarrow 3)$, and apply μ_3 . Then $\mu_3(1 \rightarrow 2 \rightarrow 3) = Q' : 1 \rightarrow 2 \leftarrow 3$. Furthermore $x_3^* x_3 = x_2 + 1$, so that $x_3^* = \frac{x_2 + 1}{x_3}$. Hence we obtain the new seed $((x_1, x_2, \frac{x_2 + 1}{x_3}), 1 \rightarrow 2 \leftarrow 3)$. Similarly, we

get $\mu_2((x_1, x_2, x_3), Q) = ((x_1, \frac{x_1+x_3}{x_2}, x_3), \overleftarrow{1\leftarrow 2\leftarrow 3})$ and $\mu_1((x_1, x_2, x_3), Q) = ((\frac{1+x_2}{x_3}, x_2, x_3), 1\leftarrow 2\rightarrow 3)$.

We continue by applying μ_1, μ_2, μ_3 to the new seeds, keeping in mind that μ_i^2 is the identity. In this example we get only a finite number of seeds, namely 14. Note that the seeds $((x_1, x_2, x_3), 1\rightarrow 2\rightarrow 3)$ and $((x_1, x_3, x_2), 1\overleftarrow{2\leftarrow 3})$ are identified, since they are the same up to relabelling.

Example 2.2. When Q is the quiver $1\longrightarrow 2$ and $F = \mathbb{Q}(x_1, x_2)$, we have the following complete picture of the graph of seeds, called the *cluster graph*.

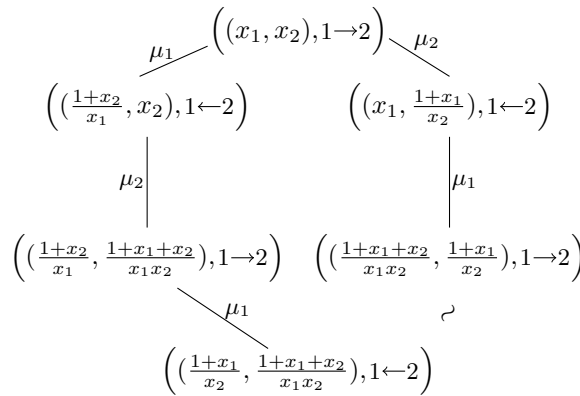

The n -element subsets occurring in the seeds are called *clusters*, and the elements occurring in the clusters are called *cluster variables*. Finally, the associated cluster algebra is the subalgebra of $\mathbb{Q}(x_1, \dots, x_n)$ generated by the cluster variables.

In Example 2.2 we have 5 clusters, and the cluster variables are the 5 elements $x_1, x_2, \frac{1+x_1}{x_2}, \frac{1+x_2}{x_1}, \frac{1+x_1+x_2}{x_1x_2}$. The cluster graph is also interesting in connection with the study of associahedra ([50],[92]).

2.2. Basic properties. In both examples above there is only a finite number of seeds, clusters and cluster variables. This is, however, not usually the case. In fact, there is the following nice description of when this holds [49].

Theorem 2.3. *Let Q be a finite connected quiver with no loops or 2-cycles. Then there are only finitely many clusters (or cluster variables, or seeds) if and only if the underlying graph of Q is a Dynkin diagram.*

Note that this result is analogous to Gabriel’s classification theorem for when there are only finitely many nonisomorphic indecomposable representations of a quiver.

A remarkable property of the cluster variables is the following [48], called the *Laurent phenomenon*.

Theorem 2.4. *Let $((x_1, \dots, x_n), Q)$ be an initial seed. When we write a cluster variable in reduced form f/g , then g is a monomial in x_1, \dots, x_n .*

We shall see later that these monomials g contain some interesting information from a representation theoretic point of view.

A cluster algebra is said to be *acyclic* if there is some seed with an acyclic quiver. In this case there is the following information on the numerators of the cluster variables, when they are expressed in terms of the cluster in a seed which has an acyclic quiver ([35],[36],[98]). The corresponding result is not known for cluster algebras in general.

Theorem 2.5. *For an acyclic cluster algebra as above, there are positive coefficients for all monomials in the numerator f of a cluster variable in reduced form.*

2.3. Cluster algebras with coefficients. Cluster algebras with coefficients are important for geometric examples of cluster algebras. Here we only consider a special case of such cluster algebras. Let $\mathbb{Q}(x_1, \dots, x_n; y_1, \dots, y_t)$ be the rational function field in $n + t$ variables, where y_1, \dots, y_t are called *coefficients*. Let Q be a finite quiver with $n + t$ vertices corresponding to $x_1, \dots, x_n, y_1, \dots, y_t$. We start with the *seed* $((x_1, \dots, x_n; y_1, \dots, y_t), Q)$. Then we only apply mutations μ_1, \dots, μ_n with respect to the first n vertices, and otherwise proceed as before. Note that Theorems 2.3 and 2.4 hold also in this setting.

There are several examples of classes of cluster algebras with coefficients, for example the homogeneous coordinate rings of Grassmanians investigated in [106] and the coordinate rings $\mathbb{C}[N]$ of unipotent groups (see [57]). There are further examples in ([14],[59],[56],[17],[61]).

The combinatorics of the cluster algebras in the case of Grassmanians of type A_n can be nicely illustrated geometrically by triangulations of a regular $(n+3)$ -gon. The cluster variables, which are coefficients, correspond to the edges of the regular $(n + 3)$ -gon, and the other cluster variables correspond to the diagonals. The clusters, without coefficients, correspond to the triangulations of the $(n + 3)$ -gon, or in other words to maximal sets of diagonals which do not intersect. We illustrate with the following simple example.

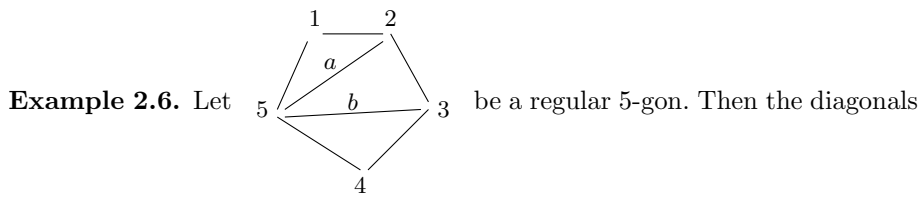

a and b correspond to cluster variables which are not coefficients, and (a, b)

is a maximal set of non intersecting diagonals. Taking corresponding cluster variables together with the coefficients, we obtain a cluster. It is easy to see that there are 5 diagonals, and 5 triangulations (see [50]).

3. Cluster Categories

It is of interest to categorify the main ingredients in the definition of cluster algebras. The idea behind this is to work within a category with extra structure, and imitate the basic operations within this new category. The hope is on one hand that this will give some feedback to the theory of cluster algebras, and on the other hand that it will lead to new interesting theories. Both aspects have been successful, for various classes of cluster algebras. In this section we deal with the acyclic ones.

3.1. Cluster structures. We first make a list of desired properties for the categories \mathcal{C} we are looking for. Let \mathcal{C} be a triangulated k -category with split idempotents, which is Hom-finite, that is, the homomorphism spaces are finite dimensional over k . Then \mathcal{C} is a Krull-Schmidt category, that is, each object is a finite direct sum of indecomposable objects with local endomorphism ring. We are looking for appropriate sets of n nonisomorphic indecomposable objects T_1, \dots, T_n , or rather objects $T = T_1 \oplus \dots \oplus T_n$, where the T_i should be the analogs of cluster variables and the T , the analogs of clusters. To have a good analog we would like these objects to satisfy the following, in which case we say that \mathcal{C} has a *cluster structure* (see [17]). \mathcal{C} has a *weak cluster structure* if (C1) and (C2) are satisfied.

(C1) For $T = T_1 \oplus \dots \oplus T_n$ in our set, there is, for each $i = 1, \dots, n$, a unique indecomposable object $T_i^* \neq T_i$ in \mathcal{C} such that $T/T_i \oplus T_i^*$ is in our set.

(C2) For each T_i there are triangles $T_i^* \xrightarrow{f} B_i \xrightarrow{g} T_i \rightarrow T_i^*[1]$ and $T_i \xrightarrow{s} B'_i \xrightarrow{t} T_i^* \rightarrow T_i[1]$, where the maps g and t are minimal right $\text{add}(T/T_i)$ -approximations and the maps f and s are minimal left $\text{add}(T/T_i)$ -approximations.

(C3) There are no loops or 2-cycles in the quiver Q_T of $\text{End}_{\mathcal{C}}(T)^{\text{op}}$. This means that any nonisomorphism $u : T_i \rightarrow T_i$ factors through $g : B_i \rightarrow T_i$ and through $s : T_i \rightarrow B'_i$, and B_i and B'_i have no common nonzero summands.

(C4) For each T in our set we have $\mu_i(Q_T) = Q_{\mu_i(T)}$.

We recall that the map $g : B_i \rightarrow T_i$ is a right $\text{add}(T/T_i)$ -approximation if B_i is in $\text{add}(T/T_i)$ and any map $h : X \rightarrow T_i$ with X in $\text{add}(T/T_i)$ factors through $g : B_i \rightarrow T_i$. The map $g : B_i \rightarrow T_i$ is right minimal if for any commutative

diagram $\begin{array}{ccc} B_i & \xrightarrow{g} & T_i \\ & \searrow s & \nearrow g \\ & B_i & \end{array}$, the map s is an isomorphism. Left approximations and

left minimal maps are defined similarly.

Note that the relationship between T_i and T_i^* required in part (C2) is similar to the formula $x_i x_i^* = m_1 + m_2$ appearing in the definition of cluster algebras.

Part (C4) is related to our discussion in Section 1 about what is needed in order to categorify quiver mutation. There we saw that tilting kQ -modules could not always be used for this purpose. However, for a class of complete algebras of Krull dimension 3, known as *3-Calabi-Yau algebras*, we shall see that actually the tilting modules (of projective dimension at most 1) can be used.

When we deal with cluster algebras with coefficients, we need a modified version of the above definition of cluster structure (see [17]).

3.2. Origins. When Q is a Dynkin quiver, it was shown in [48] that there is a one-one correspondence between the cluster variables for the cluster algebra determined by the seed $((x_1, \dots, x_n), Q)$, and the almost positive roots, that is, the positive roots together with the negative simple roots. On the other hand the positive roots are in $1 - 1$ correspondence with the indecomposable kQ -modules. This led the authors of [92] to introduce the category of *decorated* representations of Q , which are the representations of the quiver $Q \cup \{\bullet \dots \bullet\}$, that is, Q , together with n isolated vertices. Then the indecomposable representations of Q correspond to the positive roots and the n additional 1-dimensional representations correspond to the negative simple roots. A compatibility degree $E(X, Y)$ for a pair of decorated representations was introduced, and $E(X, X) = 0$ corresponds to $\text{Ext}_{kQ}^1(X, X) = 0$ when X is in $\text{mod } kQ$. The maximal such X in $\text{mod } kQ$ are the tilting modules, indicating a connection with tilting theory. On the other hand, if the cluster variables should correspond to indecomposable objects in the category we are looking for, then we would need additional indecomposable objects compared to $\text{mod } kQ$. This could also help remedy the fact that not all almost complete tilting modules in $\text{mod } kQ$ have exactly two complements in $\text{mod } kQ$. Recall that the *almost complete* tilting modules are the modules obtained from tilting modules $T = T_1 \oplus \dots \oplus T_n$, where n is the number of vertices in the quiver, by dropping one indecomposable summand. In order to have property (C4), we would also need more maps in our desired category.

Taking all this into account, it turns out to be fruitful to consider a suitable orbit category of the bounded derived category $\mathcal{D}^b(kQ)$. In the case of path algebras the bounded derived categories have a particularly nice structure.

3.3. Derived categories of path algebras. Let Q be a finite acyclic quiver, for example $1 \rightarrow 2 \rightarrow 3$ as before. Then the indecomposable objects in the

bounded derived category $\mathcal{D}^b(kQ)$ are just the objects $X[i]$ for $i \in \mathbb{Z}$, where X is an indecomposable kQ -module. Then for X and Y in $\text{mod } kQ$ we have that $\text{Hom}_{\mathcal{D}^b(kQ)}(X[i], Y[j])$ is isomorphic to $\text{Hom}_{kQ}(X, Y)$ if $i = j$, to $\text{Ext}_{kQ}^1(X, Y)$ if $j = i + 1$, and is 0 otherwise.

The category $\mathcal{D}^b(kQ)$ is a triangulated category, and it has *almost split triangles* [64], where those inside a given shift $(\text{mod } kQ)[i]$ are induced by the almost split sequences in $\text{mod } kQ$. The others are of the form $I[j-1] \rightarrow E \rightarrow P[j]$, where P is indecomposable projective in $\text{mod } kQ$, and I is the indecomposable injective module associated with the same vertex of the quiver. The operation τ is defined as for almost split sequences. Actually, in this setting it is even induced by an equivalence of categories $\tau : \mathcal{D}^b(kQ) \rightarrow \mathcal{D}^b(kQ)$ [64].

For the running example we then have the corresponding AR-quiver

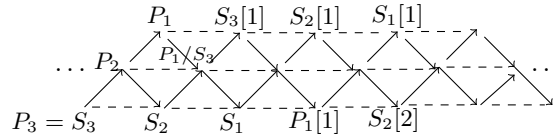

When Q' is obtained from Q by reflection at a sink (for example $1 \rightarrow 2 \leftarrow 3$ is obtained from $1 \rightarrow 2 \rightarrow 3$ in the above example), then we have seen that we have an associated tilting kQ -module T such that $\text{End}_{kQ}(T)^{\text{op}} \simeq kQ'$. Hence there is induced a derived equivalence between kQ and kQ' [64].

3.4. The cluster category. Let as before $\tau : \mathcal{D}^b(kQ) \rightarrow \mathcal{D}^b(kQ)$ denote the equivalence which induces the AR-translation, so that $\tau C = A$ if $A \rightarrow B \rightarrow C \rightarrow A[1]$ is an almost split triangle. Then $F = \tau^{-1}[1] : \mathcal{D}^b(kQ) \rightarrow \mathcal{D}^b(kQ)$ is an equivalence, where $[1]$ denotes the shift functor. We defined in [20] the cluster category \mathcal{C}_Q to be the orbit category $\mathcal{D}^b(kQ)/F$. By definition, the indecomposable objects are the F -orbits in $\mathcal{D}^b(kQ)$ of indecomposable objects, represented by indecomposable objects in the *fundamental domain* \mathcal{F} . This consists of the indecomposable objects in $\text{mod } kQ$, together with $P_1[1], \dots, P_n[1]$, where P_1, \dots, P_n are the indecomposable projective kQ -modules. So in the Dynkin case, the number of indecomposable objects in \mathcal{F} , up to isomorphism, equals the number of cluster variables. For X and Y indecomposable in \mathcal{F} we have $\text{Hom}_{\mathcal{C}_Q}(X, Y) = \bigoplus_{i=-\infty}^{\infty} \text{Hom}_{\mathcal{D}^b(Q)}(X, F^i Y)$, by the definition of maps in an orbit category. So in general we have more maps than before. For example, if Q is $1 \rightarrow 2 \rightarrow 3$, we have $\text{Hom}_{\mathcal{D}^b(Q)}(S_1, F(S_3)) \simeq k$, and $\text{Hom}_{\mathcal{D}^b(Q)}(S_1, F^i S_3) = 0$ for $i \neq 1$. Hence we have $\text{Hom}_{\mathcal{C}_Q}(S_1, S_3) \simeq k$. Now, for $T = P_1 \oplus S_1 \oplus S_3$ in \mathcal{C}_Q , we have $Q_T =: 1 \leftarrow 2 \leftarrow 3$, which coincides with $\mu_2(Q)$, as desired.

The category \mathcal{C}_Q has some nice additional structure, which orbit categories rarely have; namely they are triangulated categories [79].

3.5. Cluster tilting objects. In Section 1.6 we have seen that we could not use tilting kQ -modules to categorify quiver mutation at vertex 2 in our running example, since the quiver of the tilting module $T = P_1 \oplus S_1 \oplus P_3$ was not “correct.” But when T is viewed as an object in \mathcal{C}_Q , the associated quiver is the correct one. So it seems natural that our desired class of objects should include the tilting kQ -modules. Now, as already pointed out, there are usually different module categories of the form $\text{mod } kQ$ giving rise to the same bounded derived category $\mathcal{D}^b(kQ)$, and hence to the same cluster category. So it is natural to consider the objects in \mathcal{C}_Q induced by all the corresponding tilting modules. This class of modules turns out to have a nice uniform description as objects in \mathcal{C}_Q , which motivates the following definitions.

An object T in \mathcal{C}_Q is *maximal rigid* if $\text{Ext}_{\mathcal{C}_Q}^1(T, T) = 0$ and T is maximal with this property. It is *cluster tilting* if it is rigid and $\text{Ext}_{\mathcal{C}_Q}^1(T, X) = 0$ implies that X is in $\text{add } T$. Actually the concepts of maximal rigid and cluster tilting coincide for \mathcal{C}_Q [20].

We have the following ([20],[24]).

Theorem 3.1. *The cluster category \mathcal{C}_Q has a cluster structure with respect to the cluster tilting objects.*

As for the cluster algebras, there is also in this setting a natural associated graph, called the *cluster tilting graph*. Associated with a cluster tilting object T in \mathcal{C}_Q , we have a quiver Q_T , which is the quiver of $\text{End}_{\mathcal{C}_Q}(T)^{\text{op}}$, and hence we have a natural *tilting seed* (T, Q_T) [24]. The vertices of the cluster tilting graph correspond to the cluster tilting objects up to isomorphism, or equivalently, to the tilting seeds. We have an edge between two vertices if the two corresponding cluster tilting objects differ by exactly one indecomposable summand.

Whereas the cluster graph by definition is connected, this is not automatic for the cluster tilting graph. However, it can be shown to be the case for cluster categories ([20], using [69]), see also [72].

3.6. Categorification of quiver mutation. Note that we have in particular obtained a way of categorifying quiver mutation beyond the case of mutation at a sink as discussed in Section 1. So we isolate the more general statement as follows.

Theorem 3.2. *Let Q be a finite acyclic quiver, and Q' a quiver obtained from Q by a finite sequence of mutations. Let i be a vertex of Q' . Then there is a cluster tilting object T' in \mathcal{C}_Q such that for $T'' = \mu_i(T')$ we have the commutative diagram*

$$\begin{array}{ccc}
 T' & \xrightarrow{\mu_i} & T'' \\
 \downarrow & & \downarrow \\
 Q_{T'} = Q' & \xrightarrow{\mu_i} & \mu_i(Q') = Q_{T''}
 \end{array}$$

As an illustration of how such a categorification can be useful we state the following result [27].

Theorem 3.3. *Let Q be a finite acyclic quiver. Then the mutation class of Q is finite if and only if Q has at most two vertices, or Q is a Dynkin or an extended Dynkin diagram.*

The point of the categorification is that since the cluster tilting objects are closely related to the tilting kQ -modules, we can take advantage of the well developed theory of tilting modules over finite dimensional algebras. The problem amounts to deciding when only a finite number of quivers occur as quivers associated with tilting modules.

We point out that a classification of finite mutation type has recently been obtained in general for finite quivers without loops or 2-cycles [41].

As indicated before, quiver mutation can be categorified using tilting modules of projective dimension at most 1 for a class of algebras of Krull dimension 3 called 3-Calabi Yau algebras (see [77])

Theorem 3.4. *Let Λ be a basic 3-Calabi-Yau algebra given by a quiver Q with relations. Assume that Q has no loops or 2-cycles. Then $\mu_i(Q)$ is obtained from the quiver of $\mu_i(\Lambda)$ by removing all 2-cycles, with μ_i as defined below.*

Let $\Lambda = P_1 \oplus \dots \oplus P_n$, where the P_i are indecomposable projective Λ -modules, and $P_r \neq P_s$ for $r \neq s$ since Λ is basic. There is for a given $i = 1, \dots, n$ a unique indecomposable Λ -module P_i^* such that $\Lambda/P_i \oplus P_i^*$ is a tilting module of projective dimension at most 1, and we let $\mu_i(\Lambda) = \Lambda/P_i \oplus P_i^*$.

3.7. A geometric description. When Q is a quiver of type A_n , there is an independent categorification of the corresponding cluster algebra along very different lines [33]. This is based upon the example discussed in Section 2.3. We consider the triangulations of the regular $(n+3)$ -gon, without including the coefficients, which correspond to the edges in the $(n+3)$ -gon. A category with indecomposable objects corresponding to the diagonals in the $(n+3)$ -gon was defined in [33]. The authors showed that this category is equivalent to the cluster category of type A_n . So we get an interesting geometric description of the cluster category in the A_n case. There is also further work in this direction for D_n [105].

Cluster structures in the context of Teichmüller spaces were discussed in ([42],[43],[44], [61],[62]). This inspired the systematic study of cluster algebras coming from oriented Riemann surfaces with boundary and marked points ([41],[47]). Also in this case clusters are in bijection with triangulations. It is easy to see that the mutation class is always finite for these examples.

3.8. Hereditary categories. The theory of cluster categories also works when we replace $\text{mod } kQ$ by an arbitrary Hom-finite hereditary abelian category with tilting object [66], as pointed out in [20]. It has been shown in [11] that in the *tubular* case the cluster tilting graph is connected.

3.9. (m)-cluster categories. There is a natural generalization of the cluster categories $\mathcal{C}_Q = \mathcal{D}^b(kQ)/\tau^{-1}[1]$ to (m)-cluster categories $\mathcal{C}_Q^{(m)} = \mathcal{D}^b(kQ)/\tau^{-1}[m]$, for $m \geq 1$. Then $\mathcal{C}_Q^{(m)}$ is Hom-finite and also triangulated [79]. Some more results on cluster categories remain true in the more general setting.

We recall some work from ([109],[111],[115],[113]). The concepts of maximal rigid and cluster tilting have a natural generalization to (m)-maximal rigid and m -cluster tilting objects in $\mathcal{C}_Q^{(m)}$. Also in this setting the concepts coincide. Further, the number of nonisomorphic indecomposable summands of an m -cluster-tilting object equals the number of vertices in the quiver Q . If we drop one indecomposable summand from an m -cluster tilting object T , there are exactly m different ways to replace it by an indecomposable object, such that we still have an m -cluster tilting object.

It was shown in [29] that also for arbitrary m there is a combinatorial description of mutation of m -cluster tilting objects in m -cluster categories. In this connection the concept of *coloured* quiver mutation is introduced. There is a geometric description of the m -cluster categories for quivers of type A_n and D_n (see [12]). In the Dynkin case the concept of *m -clusters* has been introduced in [46], and it was shown in ([109],[115]) that the m -cluster category provides a categorification. This was used in ([109],[115]) to simplify proofs of results about m -clusters in [46].

4. Calabi-Yau Categories of Dimension Two

A crucial property for the investigation of cluster tilting objects in cluster categories \mathcal{C}_Q was the functorial isomorphism $D \operatorname{Ext}_{\mathcal{C}_Q}^1(A, B) \simeq \operatorname{Ext}_{\mathcal{C}_Q}^1(B, A)$, where $D = \operatorname{Hom}_k(\cdot, k)$, which by definition expresses that the Hom-finite triangulated k -category \mathcal{C}_Q is 2-Calabi-Yau (2-CY for short). A similar theory worked for $\operatorname{mod} \Lambda$ when Λ is the preprojective algebra of a Dynkin diagram [57]. Also in this case an important feature was that the stable category $\underline{\operatorname{mod}} \Lambda$ is 2-CY. Then we say that $\operatorname{mod} \Lambda$ is *stably 2-CY*. This motivated trying to generalize work from cluster categories to arbitrary Hom-finite triangulated 2-CY k -categories. We usually omit the k when we speak about k -categories.

4.1. Preprojective algebras of Dynkin type. In their work in [57] on $\operatorname{mod} \Lambda$ for Λ a preprojective algebra of Dynkin type, Geiss-Leclerc-Schröer dealt with the maximal rigid modules, as defined in Section 3. One can here go back and forth between exact sequences in $\operatorname{mod} \Lambda$ and triangles in $\underline{\operatorname{mod}} \Lambda$, so for the general theory one can deal with either one of these categories. They followed the same basic outline as in ([20],[24]), and proved that $\underline{\operatorname{mod}} \Lambda$ has a cluster structure in the terminology of Section 3. For (C2) the same proof as for cluster categories could be used, but in the other cases new proofs were necessary. This was also the case for showing that the concepts of maximal rigid

and cluster tilting coincide also in this context. For this work some of the results of Iyama on a higher theory of almost split sequences and Auslander algebras were useful ([74],[75]). Actually, in this work Iyama introduced independently the concept of maximal 1-orthogonal, which coincides with cluster tilting in the setting of (stably) 2-CY categories.

The cluster algebras $\mathbb{C}[N]$ are categorified using the cluster tilting objects in the category $\text{mod } \Lambda$ for a preprojective algebra Λ of Dynkin type. All the indecomposable projective modules are summands of any cluster tilting object, and correspond to the coefficients of the associated cluster algebra. Actually, here categorification can be used to show that $\mathbb{C}[N]$ has a cluster algebra structure (see [57]). This has recently been generalized in [56].

Cluster monomials are monomials of cluster variables in a given cluster. A central question is their relationship to the canonical and semicanonical bases and their duals, investigated by Lusztig and Kashiwara (see [57],[58]).

4.2. Generalizations. In the general case of stably 2-CY categories, or Hom-finite triangulated 2-CY categories, there are not necessarily any cluster tilting objects. Actually, there may be maximal rigid objects, but no cluster tilting objects [30]. But we have the following general result [78].

Theorem 4.1. *Let \mathcal{C} be a Hom-finite triangulated 2-CY category with cluster tilting objects. Then \mathcal{C} has a weak cluster structure.*

The proof of (C2) is the same as for cluster categories, while a new argument was needed for (C1). Property (C3) does not however hold in general. There are many examples of stable categories of Cohen-Macaulay modules over isolated hypersurface singularities where there are both loops and 2-cycles [30]. But if there are no loops or 2-cycles, then we have the following [17].

Theorem 4.2. *Let \mathcal{C} be a Hom-finite 2-CY triangulated k -category having cluster tilting objects, and with no loops or 2-cycles. Then \mathcal{C} has a cluster structure.*

We have pointed out that the cluster tilting graph is known to be connected for cluster categories \mathcal{C}_Q when Q is a finite connected quiver. This is an important open problem for connected Hom-finite triangulated 2-CY categories in general. The only other cases where this is known to be true is for the case discussed in Section 3.8, and for some cases of stable categories of Cohen-Macaulay modules in [30].

4.3. 2-CY categories associated with elements in Coxeter groups. Let Q be a finite acyclic quiver with vertices $1, \dots, n$, and let C_Q be the associated Coxeter group. By definition C_Q has a distinguished set of generators s_1, \dots, s_n , and the relations are as follows: $s_i^2 = 1$, $s_i s_j = s_j s_i$ if there is no arrow between i and j in Q , and $s_i s_j s_i = s_j s_i s_j$ if there is

exactly one arrow between i and j . Let $\mathbf{w} = s_{i_1} \dots s_{i_t}$ be a *reduced expression* of w in \mathcal{C}_Q , that is, t is smallest possible. Let Λ be the (completion of the) preprojective algebra associated with Q . For each $i = 1, \dots, n$, consider the ideal $I_i = \Lambda(1 - e_i)\Lambda$ in Λ , where e_i denotes the trivial path at the vertex i . Then define the ideal $I_{\mathbf{w}} = I_{i_1} \dots I_{i_t}$. It can be shown to be independent of the reduced expression, and the factor algebra $\Lambda_{\mathbf{w}} = \Lambda/I_{\mathbf{w}}$ is finite dimensional. Denote by $\text{Sub}\Lambda_{\mathbf{w}}$ the full subcategory of $\text{mod}\Lambda_{\mathbf{w}}$ whose objects are the submodules of the free $\Lambda_{\mathbf{w}}$ -modules of finite rank. Then $\mathcal{C}_{\mathbf{w}} = \text{Sub}\Lambda_{\mathbf{w}}$ is stably 2-CY, and the associated stable category $\underline{\text{Sub}}\Lambda_{\mathbf{w}}$ is Hom-finite triangulated 2-CY. Here we refer to ([77],[17]).

There is a nice class of cluster tilting objects, called *standard* cluster tilting objects, in $\text{Sub}\Lambda_{\mathbf{w}}$ and $\underline{\text{Sub}}\Lambda_{\mathbf{w}}$. When $\mathbf{w} = s_{i_1} \dots s_{i_t}$ is a reduced expression we define

$$T_{\mathbf{w}} = (P_{i_1}/I_{i_1}P_{i_1}) \oplus (P_{i_2}/I_{i_1}I_{i_2}P_{i_2}) \oplus \dots \oplus (P_{i_t}/I_{i_1} \dots I_{i_t}P_{i_t}).$$

Then $T_{\mathbf{w}}$ is a cluster tilting object in $\text{Sub}\Lambda_{\mathbf{w}}$ and in $\underline{\text{Sub}}\Lambda_{\mathbf{w}}$, and it depends on the reduced expression. However, the standard cluster tilting objects all lie in the same component of the cluster tilting graph [17].

A stably 2-CY category, dual to $\mathcal{C}_{\mathbf{w}}$, was independently associated with a class of words called *adaptable*, in a very different way [55]. Here there were also associated two cluster tilting objects in a natural way, which are a subset of the set of standard cluster tilting objects (up to duality).

4.4. Stable categories of Cohen-Macaulay modules. Let R be a commutative complete local Gorenstein isolated singularity of Krull dimension 3, with $k \subset R$ for the field k . Then by results of Auslander [7] on existence of almost split sequences for (maximal) Cohen-Macaulay modules, the category of Cohen-Macaulay modules $\text{CM}(R)$ is stably 2-CY and the stable category $\underline{\text{CM}}(R)$ is Hom-finite triangulated 2-CY.

When R is an isolated hypersurface singularity, we can, by the periodicity result for hypersurfaces ([88],[108]), deal with the case of Krull dimension 1 just as well. Already for finite Cohen-Macaulay type there are examples with no cluster tilting objects, and where there are maximal rigid objects which are not cluster tilting [30]. For all these examples there are 2-cycles, and in many cases also loops. An interesting question in this connection is the following. Let \mathcal{C} be a Hom-finite triangulated 2-CY k -category, where we have no loops or 2-cycles. Then do the maximal rigid objects coincide with the cluster tilting objects?

Another class of Gorenstein rings giving rise to 2-CY categories with desired properties is the following. Let $G \subset SL(3, k)$ be a finite subgroup where no $g \neq 1$ in G has eigenvalue 1, and let $R = k[[X, Y, Z]]^G$ be the associated invariant ring, which under these assumptions is an isolated singularity. Then $\underline{\text{CM}}(R)$ is Hom-finite triangulated 2-CY, and does not have loops or 2-cycles [90].

4.5. Generalized cluster categories. In [1] Amiot introduced a new class of Hom-finite triangulated 2-CY -categories, generalizing the class of cluster categories.

Let A be a finite dimensional k -algebra of global dimension at most 2. Also under this assumption $\mathcal{D}^b(A)$ has almost split triangles, and the AR-translation τ is induced by an equivalence $\tau : \mathcal{D}^b(A) \rightarrow \mathcal{D}^b(A)$ [64]. Consider again the orbit category $\mathcal{D}^b(A)/\tau^{-1}[1]$. In this setting the orbit category is not necessarily triangulated. The *generalized cluster category* \mathcal{C}_A is then defined to be the *triangulated hull* of $\mathcal{D}^b(A)/\tau^{-1}[1]$. If $\text{Hom}_{\mathcal{C}_A}(A, A)$ is finite dimensional, then \mathcal{C}_A is Hom-finite triangulated 2-CY , with A as a cluster tilting object (see [1]).

A striking application of these generalized cluster categories is Keller's proof of the periodicity conjecture for pairs of Dynkin diagrams [81] (see also [73]), using the algebra $A = kQ \otimes_k kQ$ of global dimension at most 2, where Q is a Dynkin quiver.

A more general construction of Hom-finite triangulated 2-CY categories was given in ([1],[84]), starting with a quiver with potential (Q, W) such that the associated Jacobian algebra is finite dimensional (see Section 5). There is an associated differential graded algebra Γ , called the Ginzburg algebra, and a triangulated 2-CY category $\mathcal{C}_{(Q,W)}$ was constructed from Γ . By ([1],[84]) this generalizes the previous construction of \mathcal{C}_A from A .

4.6. Relationship between the different classes. A natural question to ask is how the various classes of Hom-finite triangulated 2-CY categories are related.

We first show how the cluster categories and the preprojective algebras of Dynkin type are related to the 2-CY categories associated with elements in Coxeter groups ([17],[55]).

Theorem 4.3. (a) *The cluster category \mathcal{C}_Q is triangle equivalent to the category $\text{Sub}\Lambda_w$, where $w = c^2$ for a Coxeter element c , when Q is not of type A_n .*

(b) *When Q is Dynkin and Λ is the associated preprojective algebra, then $\text{mod } \Lambda$ is $\text{Sub } \Lambda_w$, where w is the longest element in the Coxeter group.*

The following was shown in ([1],[3],[4]).

Theorem 4.4. *Let \mathcal{C}_w be a Hom-finite triangulated 2-CY category associated with an element in a Coxeter group. Then there is some algebra A of global dimension at most 2 such that \mathcal{C}_w is triangle equivalent to the generalized cluster category \mathcal{C}_A .*

Another result of a similar flavour was recently shown in ([2],[38]).

Theorem 4.5. *Let $R = k[[X, Y, Z]]^G$ be an invariant ring as discussed above, where $G \subset SL(3, k)$ is a finite cyclic group. Then the 2-CY triangulated category*

$\underline{\text{CM}}(R)$ is triangle equivalent to a generalized cluster category \mathcal{C}_A for some finite dimensional algebra A of global dimension at most 2.

4.7. Subfactor constructions. There is also a useful way of constructing new Hom-finite triangulated 2-CY categories from old ones, via subfactor constructions [78].

Let \mathcal{C} be a Hom-finite triangulated 2-CY category with a nonzero rigid object D . Let ${}^\perp D[1] = \{X \in \mathcal{C}; \text{Ext}_{\mathcal{C}}^1(X, D) = 0\}$. Then the factor category ${}^\perp D[1]/\text{add } D$ is triangulated 2-CY. The cluster tilting objects in ${}^\perp D[1]/\text{add } D$ are in one-one correspondence with the cluster tilting objects of \mathcal{C} which have D as a summand.

This was proved in the general case in [78]. Related results for the cluster categories were first proved in [24]. There they were used to show that if an algebra Γ is cluster tilted, then $\Gamma/\Gamma e\Gamma$ is cluster tilted for any idempotent element e of Γ (see Section 5 for definition). This was useful for reducing problems to algebras with fewer simple modules.

When $\mathbf{w} = \mathbf{uv}$ is a reduced expression in a Coxeter group, then the 2-CY triangulated category $\underline{\text{Sub}}\Lambda_v$ is triangle equivalent to a specific subfactor category of $\underline{\text{Sub}}\Lambda_w$ [76]. This was used to get information on components of cluster tilting graphs for $\underline{\text{Sub}}\Lambda_w$ [76].

5. 2-Calabi-Yau Tilted Algebras and Jacobian Algebras

The study of cluster categories gave rise to an interesting class of finite dimensional algebras, obtained by taking endomorphism algebras of cluster tilting objects. They have been called *cluster tilted algebras* [23], and are in some sense analogous to the tilted algebras in the representation theory of finite dimensional algebras. But their properties are quite different, from several points of view. The cluster tilted algebras have a natural generalization to what has been called *2-CY -tilted algebras*, where in the definition we replace cluster categories by Hom-finite triangulated 2-CY -categories. In this section we give some basic properties of these algebras, and discuss their relationship to another important class of algebras; the Jacobian algebras associated with quivers with potential ([39],[40]).

5.1. Special properties of cluster tilted algebras. The following result from [5] gives a procedure for passing from a tilted algebra to a cluster tilted algebra (see also ([114],[104])). It has no known analog in the general case of 2-CY -tilted algebras.

Theorem 5.1. *Let Γ be a tilted algebra. Then the trivial extension algebra $\Gamma \rtimes \text{Ext}_{\Gamma}^2(D\Gamma, \Gamma)$ is cluster tilted.*

In practice, this is interpreted to amount to drawing an additional arrow from j to i in the quiver of Γ , for each relation from i to j in a minimal set of relations for Γ . In the case of finite representation type, this construction was first made in [26], and also used in [28] for a small class of algebras of infinite representation type.

For example, if Q is the quiver $1 \xrightarrow{\alpha} 2 \xrightarrow{\beta} 3$ and $\Gamma = kQ/\langle\beta\alpha\rangle$, then the quiver of $\Gamma \rtimes \text{Ext}_\Gamma^2(D\Gamma, \Gamma)$ is $1 \xleftarrow{\quad} 2 \xrightarrow{\quad} 3$

Another interesting property of cluster tilted algebras, not shared by tilted algebras or by 2-CY -tilted algebras in general, is the following [18].

Theorem 5.2. *A cluster tilted algebra is determined by its quiver.*

In the case of finite representation type this was proved in [21], where also the relations were described. Part of the finite type case was also proved independently in [32]. In general there is no known way of constructing the unique cluster tilted algebra associated with a given quiver.

The following example shows that the corresponding result does not hold for tilted algebras, since for the quiver $Q : 1 \xrightarrow{\alpha} 2 \xrightarrow{\beta} 3$, both kQ and $kQ/\langle\beta\alpha\rangle$ are tilted algebras. If Q is the quiver $1 \xleftarrow{\alpha} 2 \xrightarrow{\beta} 3$, then $kQ/\langle\beta\alpha, \gamma\beta, \alpha\gamma\rangle$ and $kQ/\langle\beta\alpha\gamma\beta\alpha, \gamma\beta\alpha\gamma\beta, \alpha\gamma\beta\alpha\gamma\rangle$ can both be shown to be 2-CY -tilted algebras, even though they have the same quiver. Here only the first one is cluster tilted.

5.2. Homological properties. The central properties of cluster tilted algebras of a homological nature remain valid also in the general case of 2-CY -tilted algebras. A Hom-finite triangulated category \mathcal{C} with split idempotents is 3-CY if we have a functorial isomorphism $D(\text{Ext}^1(X, Y)) \simeq \text{Ext}^2(Y, X)$ for X, Y in \mathcal{C} .

Theorem 5.3. *Let \mathcal{C} be a Hom-finite triangulated 2-CY category, T a cluster tilting object in \mathcal{C} , and let $\Gamma = \text{End}_{\mathcal{C}}(T)^{\text{op}}$. Then we have the following.*

- (a) *The functor $\text{Hom}_{\mathcal{C}}(T,) : \mathcal{C} \rightarrow \text{mod } \Gamma$ induces an equivalence of categories $\mathcal{C}/\text{add } \tau T \xrightarrow{\sim} \text{mod } \Gamma$.*
- (b) *Γ is Gorenstein of injective dimension at most 1.*
- (c) *The stable category $\underline{\text{Sub}} \Gamma$ is triangulated 3-CY.*

Part (a) was proved in [23] for cluster tilted algebras and in [85] in general. Parts (b) and (c) were proved in [85].

Part (a) expresses a close relationship between \mathcal{C} and $\text{mod } \Gamma$. For example, on the level of objects, the indecomposable objects in $\text{mod } \Gamma$ are obtained from those in \mathcal{C} by dropping the indecomposable summands of τT (which are only finite in number). The category \mathcal{C} has almost split triangles inherited from

the almost split triangles in $\mathcal{D}^b(kQ)$, and by dropping the indecomposable summands of τT one obtains the AR-quiver of $\text{mod } \Gamma$. Since \mathcal{C} and $\text{mod } \Gamma$ are closely related, then also $\text{mod } \Gamma$ and $\text{mod } \Gamma'$ are closely related when $\Gamma' = \text{End}(T')^{\text{op}}$ for some cluster tilting object T' in \mathcal{C} . In particular, we have the following ([23],[85]), which generalizes Theorem 1.2.

Theorem 5.4. *Let the notation be as above, and assume in addition that T' is obtained from T by a mutation. Then Γ and Γ' are nearly Morita equivalent, that is, there are simple modules S and S' over Γ and Γ' respectively, such that the factor categories $\text{mod } \Gamma / \text{add } S$ and $\text{mod } \Gamma' / \text{add } S'$ are equivalent.*

Here the objects in $\text{add } S$ are finite direct sums of copies of S , and the maps in $\text{mod } \Gamma / \text{add } S$ are the usual Γ -homomorphisms modulo those factoring through an object in $\text{add } S$.

In view of the close relationship between \mathcal{C} and $\text{mod } \Gamma$, it is natural to ask if $\text{mod } \Gamma$ determines \mathcal{C} . It is not known if this holds in general, but there is the following information [86], which was essential for the proof of Theorem 4.3.

Theorem 5.5. *Let \mathcal{C} be a Hom-finite triangulated 2-CY category over the field k , and assume that \mathcal{C} is algebraic (see [86]). If there is a cluster tilting object in \mathcal{C} whose associated quiver Q has no oriented cycles, then \mathcal{C} is triangle equivalent to the cluster category \mathcal{C}_Q .*

5.3. Relationship to Jacobian algebras. It was clear from the beginning of the theory that many examples of cluster tilted algebras, and later of 2-CY tilted algebras, were given by quivers with potentials. This is a class of algebras appearing in the physics literature [13], and they have been systematically investigated in ([39],[40]). We refer to [39] for the general definition of quiver with potential. In particular, a theory of mutations of quivers with potential has been developed.

For example if we have the quiver $1 \begin{array}{c} \xleftarrow{\alpha} 2 \xrightarrow{\beta} \\ \xrightarrow{\gamma} 3 \end{array}$, we can consider the

potential $W = \gamma\beta\alpha$, which is a cycle. Taking the derivatives with respect to the arrows α, β, γ , up to cyclic permutation, we get $\partial W / \partial \alpha = \gamma\beta$, $\partial W / \partial \beta = \alpha\gamma$, $\partial W / \partial \gamma = \beta\alpha$. Using these elements as a generating set for the relations, we obtain the first algebra in the example in Section 5.1. If we take the potential $W = \gamma\beta\alpha\gamma\beta\alpha$, we get the second algebra.

The algebras associated with a quiver with potential (Q, W) as above are called *Jacobian algebras* and denoted by $\text{Jac}(Q, W)$. They are not necessarily finite dimensional. For example, the 3-CY algebras of Krull dimension 3 mentioned in Section 3 are often Jacobian.

The connection between 2-CY -tilted and Jacobian algebras indicated by the above examples is not accidental. In fact we have the following ([1],[84]).

Theorem 5.6. *Any finite dimensional Jacobian algebra is 2-CY -tilted.*

It is an open problem whether any 2-CY -tilted algebra is Jacobian. But in many situations this is known to be the case. For example we have the following ([18],[84]) (see also [84] and Corollary 5.12 for more general results).

Theorem 5.7. *Any cluster tilted algebra is Jacobian.*

For the 2-CY -tilted algebras associated with standard cluster tilting objects in $\text{Sub}\Lambda_w$, there is an explicit description of the quiver in terms of the reduced expression [17]. The same quiver appeared in [14] in the Dynkin case. In [18] the following was shown.

Theorem 5.8. *Let w be an element in a Coxeter group. Then the 2-CY -tilted algebras associated with the standard cluster tilting objects in $\text{Sub}\Lambda_w$ are Jacobian.*

We illustrate with the following.

Example 5.9. Let Q be the quiver $1 \xrightarrow{a} 2 \xrightarrow{b} 3$ and $\mathbf{w} = s_1 s_2 s_3 s_1 s_2 s_1$ a reduced expression. Let T be the corresponding cluster tilting object in $\text{Sub}\Lambda_w$. Then $\text{End}(T)^{\text{op}}$ and $\underline{\text{End}}(T)^{\text{op}}$ have quivers

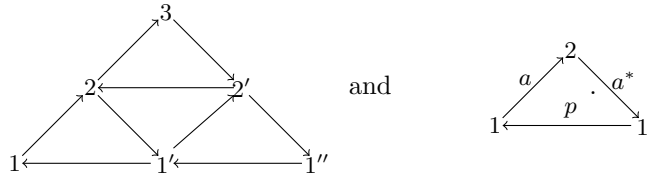

For the second quiver we have the potential $W = pa^*a$, and $\underline{\text{End}}(T)^{\text{op}} \simeq \text{Jac}(Q, W)$.

5.4. Mutation of quivers with potentials. Let (Q, W) be a quiver with potential, where Q is a finite quiver with no loops. Then a mutation $\mu_i(Q, W)$ is defined in [39] (see also [13]), when i does not lie on a 2-cycle. Here we illustrate the definition on an example.

Example 5.10. Let Q be the quiver $1 \xrightarrow{a} 2 \xrightarrow{b} 3$, and $W = cba$ a potential.

We first define $\tilde{\mu}_i(Q, W) = (\tilde{Q}, \tilde{W})$, where \tilde{Q} is the quiver $1 \xleftarrow{a^*} 2 \xleftarrow{b^*} 3$ and

$\tilde{W} = c[ba] + a^*b^*[ba]$. Here we have replaced the path ba of length 2 going through the vertex 2 by a new arrow $[ba]$, and we have added a new term $a^*b^*[ba]$ in the potential. Since \tilde{W} has a term which is a cycle of length 2, it is by definition not *reduced*. In the next step we get rid of cycles of length 2 in the potential, and obtain $\mu_2(Q, W) = (\bar{Q}, \bar{W})$, where \bar{Q} is $1 \xleftarrow{a^*} 2 \xleftarrow{b^*} 3$ and $\bar{W} = 0$.

In general \bar{Q} may have 2-cycles. Then \bar{Q} coincides with $\mu_2(Q)$ only after removing all 2-cycles. If we require to remove all 2-cycles, mutation of quivers with potential gives a categorification of quiver mutation.

5.5. Comparing mutations. Since there is a large intersection between the classes of Jacobian algebras and 2-CY -tilted algebras, it makes sense to ask if the mutations of cluster tilting objects and of quivers with potential are closely related (see [18]).

Consider the following diagram, where T is a cluster tilting object in a Hom-finite triangulated 2-CY category \mathcal{C} , and (Q, W) is a quiver with potential. We assume that $\text{End}_{\mathcal{C}}(T)^{\text{op}} \simeq \text{Jac}(Q, W)$, and consider the diagram

$$\begin{array}{ccc}
 T & \xrightarrow{\quad} & \mu_i(T) \\
 \downarrow & & \downarrow \\
 \text{End}(T)^{\text{op}} & & \text{End}(\mu_i(T))^{\text{op}} \\
 \text{Jac}(Q, W) & & \text{Jac}(\bar{Q}, \bar{W}) \\
 \uparrow & & \uparrow \\
 (Q, W) & \xrightarrow{\quad} & \mu_i(Q, W) = (\bar{Q}, \bar{W})
 \end{array}$$

It is not clear whether any cluster tilting object T' with $\text{End}(T')^{\text{op}} \simeq \text{End}(T)^{\text{op}}$ gives rise to an algebra $\text{End}(\mu_i(T'))^{\text{op}}$ which is isomorphic to $\text{End}(\mu_i(T))^{\text{op}}$. Similarly, it is not clear if a quiver with potential $\mu_i(Q', W')$ gives rise to an algebra isomorphic to $\text{Jac}(\mu_i(Q, W))$ when $\text{Jac}(Q, W) \simeq \text{Jac}(Q', W')$. The latter was posed as a problem in [39]. It was solved in the finite dimensional case, as a consequence of the following [18].

Theorem 5.11. *Let the notation be as above, and assume that we have an isomorphism $\text{End}(T)^{\text{op}} \simeq \text{Jac}(Q, W)$.*

- (a) *For any choice of T and of (Q, W) in the isomorphism $\text{End}(T)^{\text{op}} \simeq \text{Jac}(Q, W)$, we have $\text{End}(\mu_i(T))^{\text{op}} \simeq \text{Jac}(\mu_i(Q, W))$.*
- (b) *As a consequence, the assignment $\text{End}(T)^{\text{op}} \mapsto \text{End}(\mu_i(T))^{\text{op}}$ is independent of the choice of T and the assignment $\text{Jac}(Q, W) \mapsto \text{Jac}(\bar{Q}, \bar{W})$ is independent of the choice of (Q, W) .*

We have the following important consequence.

Corollary 5.12. *If a 2-CY -tilted algebra is Jacobian, then all 2-CY -tilted algebras belonging to the same component in the cluster tilting graph are Jacobian.*

Note that this gives an easy proof of the fact that a cluster tilted algebra is Jacobian, since kQ is clearly Jacobian, and we know that there is only one component in this case.

It also follows, using Corollary 5.12, that any 2-CY -tilted algebra belonging to the same component of the cluster tilting graph as those coming from standard cluster tilting objects in categories $\text{Sub}\Lambda_w$ are Jacobian. This emphasizes the importance of the problem of proving the existence of only one component in general.

We have seen that for a cluster tilting object T in a triangulated 2-CY category \mathcal{C} , then $\text{End}(T)^{\text{op}}$ and $\text{End}(\mu_i(T))^{\text{op}}$ are nearly Morita equivalent. Hence the corresponding result holds for *neighbouring* finite dimensional Jacobian algebras by Theorems 5.4, 5.6 and 5.11. Actually, the following more general result holds ([18],[40],[87]).

Theorem 5.13. *If Λ and Λ' are neighbouring Jacobian algebras, then the categories of finite dimensional modules over Λ and Λ' are nearly Morita equivalent.*

The 3-Calabi-Yau tilted algebras mentioned in Sections 3.1 and 3.6 are sometimes given by quivers with potential, and for these algebras we have mutation using tilting modules of projective dimension at most 1. Also in this setting the mutation of quivers with potential is closely related to the mutation of tilting modules [18].

Theorem 5.14. *Assume that T is a tilting module of projective dimension at most 1 over a 3-CY-algebra, where $\text{End}(T)^{\text{op}} \simeq \text{Jac}(Q, W)$. Then $\text{End}(\mu_i(T))^{\text{op}} \simeq \text{Jac}(\mu_i(Q, W))$.*

In particular, it follows that $\text{Jac}(\mu_i(Q, W))$ is obtained from $\text{Jac}(Q, W)$ via a tilting module T of projective dimension at most 1.

5.6. Derived equivalence. As discussed above, it was shown in [77] that for 3-CY-algebras quiver mutation can be categorified using mutation of tilting modules of projective dimension at most 1, similar to the original case of categorifying reflections at sinks discussed in Section 1. And a tilting module gives rise to a derived equivalence [64].

It is known from [39] that for any finite quiver Q without loops or 2-cycles, there is some potential W with the following property. For any quiver with potential (Q', W') obtained from (Q, W) by a finite sequence of mutations, the quiver Q' has no loops or 2-cycles. Then the operation μ_i taking (Q, W) to $\mu_i(Q, W) = (\mu_i(Q), \overline{W})$ is directly a categorification of the quiver mutation taking Q to $\mu_i(Q)$, without having to remove any 2-cycles after performing the mutation μ_i on (Q, W) . The following result from [87] is a generalization of the results in [77].

Theorem 5.15. *With the above notation, the Ginzburg algebras associated with (Q, W) and $\mu_i(Q, W)$ are derived equivalent.*

6. Applications to Cluster Algebras

The categorification of various classes of cluster algebras is an interesting problem itself. We have seen that the special case of categorifying quiver mutation in the acyclic case led to information on cluster algebras, namely a characterization of the acyclic cluster algebras having only a finite number of quivers occurring in the seeds. Categorification has also been used to discover new cluster algebras and to categorify old ones. In order to use categorification to obtain additional information on cluster algebras, it is of interest to define maps with nice properties between cluster variables and indecomposable rigid objects, and show that they are injective and/or surjective.

6.1. The Dynkin case. For Dynkin diagrams it was already known from [49] and [92] that there is a bijection between the cluster variables and the almost positive roots, hence a bijection between cluster variables and indecomposable decorated representations. For the associated cluster category \mathcal{C}_Q we have a natural correspondence between the negative simple roots $-s_1, \dots, -s_n$ and the indecomposable objects $P_1[1], \dots, P_n[1]$ in the cluster category. Here P_i is the projective cover of the simple kQ -module S_i corresponding to the simple root s_i . Then we have the following [20].

Theorem 6.1. *Let Q be a Dynkin quiver of type A_n, D_n, E_6, E_7 or E_8 and $\mathcal{A}(Q)$ the associated cluster algebra with no coefficients. Then there is a bijection from the cluster variables of $\mathcal{A}(Q)$ to the indecomposable (rigid) objects in the cluster category \mathcal{C}_Q , sending clusters to cluster tilting objects.*

6.2. From cluster algebras to cluster categories. It was conjectured in [20] that there should be a bijection as in Theorem 6.1 in the general acyclic case. Relevant maps have been defined in both directions in order to deal with this problem. Here we start with defining a natural map α from cluster variables to indecomposable rigid objects [25].

Let $((x_1, \dots, x_n), Q)$, with Q a finite connected acyclic quiver, be the initial seed. Then define $\alpha(x_i) = P_i[1]$ for $i = 1, \dots, n$. The mutation $\mu_i((x_1, \dots, x_n), Q)$ creates a new cluster variable x_i^* , which is sent to the indecomposable rigid object $P_i[i]^*$, where $P_i[1]^* \neq P_i[1]$ and $(kQ/P_i[1]) \oplus P_i[1]^*$ is a cluster tilting object in \mathcal{C}_Q . We continue this procedure, and prove that the map α is well-defined. Here we use heavily property (C4) of a cluster structure, as proved in [24]. To show that α is surjective one uses that the cluster tilting graph is connected. Then one shows that the map α on cluster variables induces a map from clusters to cluster tilting objects.

Already from these properties of α one gets the following, which was proved independently in [25] and [34] for acyclic cluster algebras.

Theorem 6.2. *For acyclic cluster algebras with no coefficients, a seed is determined by its cluster.*

This has later been generalized in [60] using other methods.

6.3. Interpretation of denominators. Let $((x_1, \dots, x_n), Q)$ be the initial seed, where Q is an acyclic quiver. The denominator of a cluster variable (different from (x_1, \dots, x_n)), expressed in the variables x_1, \dots, x_n , determines the composition factors of a unique indecomposable rigid kQ -module. This is proved in [25] at the same time as constructing the surjective map α discussed in 6.2. For example, for $Q : 1 \longrightarrow 2 \longrightarrow 3$ the cluster variable $f/x_1x_2x_3$ in reduced form is sent by α to the unique indecomposable rigid kQ -module which has composition factors S_1, S_2, S_3 , and this is P_1 .

The surprisingly simple, but extremely useful, idea of *positivity condition* was crucial for the proof. This says that if $f = f(x_1, \dots, x_n)$ has the property that if $f(e_i) > 0$, where $e_i = (1, \dots, 1, 0, 1, \dots, 1)$, for $i = 1, \dots, n$, then f/m , where m is a non constant monomial, is in reduced form.

The approach sketched above is taken from [25]. This type of connection between denominators and indecomposable rigid objects was first shown in [48] for Dynkin diagrams with alternating orientation, then in [32] and [101] for the general Dynkin case, with another approach in [35]. Note that only using the approach sketched above there could still theoretically be different cluster variables f/m and f'/m in reduced form, with the same monomial m . Another approach to the denominator theorem is given in [34], where also the above positivity condition from [25] is used, together with the Caldero-Chapoton map, which we discuss next. Using this map, it follows that m determines f/m (see also [71]).

Note that when we express the cluster variables in terms of a seed different from the initial one, the denominators do not necessarily determine an indecomposable rigid module [22]. This fact was useful in [52] for giving a counterexample to a conjecture in [51].

6.4. From cluster categories to cluster algebras. We now define a map from indecomposable rigid objects in cluster categories to cluster variables in the corresponding cluster algebras. This beautiful work was started in [31] for the Dynkin case, with the following definition.

Let M be in $\text{mod } kQ$. Then define

$$X_M = \sum_{\mathbf{e}} \chi(\text{Gr}_{\mathbf{e}}(M)) \prod_i u_i^{-\langle \mathbf{e}, \alpha_i \rangle - \langle \alpha_i, \mathbf{m} - \mathbf{e} \rangle}.$$

Here $\text{Gr}_{\mathbf{e}}(M) = \{N \in \text{mod } kQ; N \subset M, \underline{\dim} N = \mathbf{e}\}$, where $\mathbf{e} = (e_1, \dots, e_n) \leq \mathbf{m} = (m_1, \dots, m_n)$, which denotes the dimension vector of M . Further \langle, \rangle denotes the Euler form defined on the Grothendieck group of $\text{mod } kQ$. For M, N in $\text{mod } kQ$ it is defined by $\langle M, N \rangle = \dim_k \text{Hom}_{kQ}(M, N) - \dim_k \text{Ext}_{kQ}^1(M, N)$. Finally χ denotes the Euler-Poincaré characteristic of the quiver Grassmanian. Further we define $X_{P_i[1]} = u_i$, where P_1, P_2, \dots, P_n are the indecomposable projective kQ -modules.

We illustrate with the following.

Example 6.3. Let Q be the quiver $1 \longrightarrow 2 \longrightarrow 3$. We compute X_{S_2} . We have $\mathbf{e} = (0, 0, 0)$ or $\mathbf{e} = (0, 1, 0)$. In both cases $\chi(Gr_{\mathbf{e}}(S_2)) = 1$.

Assume first $\mathbf{e} = (0, 0, 0)$. Then we have

$$u_1^{-\langle 0, \alpha_1 \rangle - \langle \alpha_1, \alpha_2 \rangle} u_2^{-\langle 0, \alpha_2 \rangle - \langle \alpha_2, \alpha_2 \rangle} u_3^{-\langle 0, \alpha_2 \rangle - \langle \alpha_3, \alpha_2 \rangle} = u_1/u_2$$

since $\text{Ext}_{kQ}^1(S_1, S_2) \simeq k$ and $\text{Ext}_{kQ}^1(S_3, S_2) = 0$.

Assume then that $\mathbf{e} = \alpha_2$. Then we have

$$u_1^{-\langle \alpha_2, \alpha_1 \rangle} u_2^{-\langle \alpha_2, \alpha_2 \rangle} u_3^{-\langle \alpha_2, \alpha_3 \rangle} = u_3/u_2$$

Hence we get

$$X_{S_2} = u/u_2 + u_3/u_2 = (u_1 + u_3)/u_2.$$

The following is the main result of [31].

Theorem 6.4. *In the Dynkin case, the $\mathbb{Q}[u_1, \dots, u_n]$ -submodule of $\mathbb{Q}(u_1, \dots, u_n)$ generated by the X_M for M an indecomposable kQ -module, coincides with the cluster algebra $\mathcal{A}(Q)$, and the set of cluster variables is given by*

$$\{u_i; 1 \leq i \leq n\} \cup \{X_M; M \text{ indecomposable module in mod } kQ\}.$$

The Caldero-Chapoton formula was generalized to the acyclic case in [34]. The corresponding map β from the indecomposable rigid objects in the cluster category to the cluster variables in the associated cluster algebra was shown to be surjective, and also injective by using the positivity condition from the previous subsection. One then has the following [34] (see also [25, Appendix]).

Theorem 6.5. *There is a map β from the indecomposable objects in the cluster category \mathcal{C}_Q for a finite acyclic quiver Q to the associated cluster algebra, $\mathcal{A}(Q)$, with no coefficients, such that there is induced*

- (1) a bijection from the indecomposable rigid objects to the cluster variables
- (2) a bijection between the cluster tilting objects in \mathcal{C}_Q and the clusters for $\mathcal{A}(Q)$.

Some further feedback to acyclic cluster algebras is then given as a result of this tighter connection, for example the following [25, Appendix].

Theorem 6.6. *If $\{u_1, \dots, u_n\}$ is a cluster in an acyclic cluster algebra with no coefficients, there is for each $i = 1, \dots, n$, a unique element $u_i^* \neq u_i$ such that $\{u_1, \dots, u_i^*, u_{i+1}, \dots, u_n\}$ is a cluster.*

This has later been generalized to cluster algebras of *geometric* type in [60], using different methods.

There is another variation of the Caldero-Chapoton formula in [95], where the case of an arbitrary initial seed in an acyclic cluster algebra was treated. In that connection Palu formulated the desired properties needed in order to obtain a good map from a 2-CY triangulated category \mathcal{C} to a commutative ring R , called a *cluster character* χ [95] (see also [17]). The requirement was that

- (i) $\chi(A) = \chi(B)$ if $A \simeq B$.
- (ii) $\chi(A \oplus B) = \chi(A)\chi(B)$.
- (iii) If $\dim \text{Ext}^1(X, Y) = 1$ for indecomposable objects X and Y in \mathcal{C} , consider the non split triangles $X \rightarrow B \rightarrow Y \rightarrow X[1]$ and $Y \rightarrow B' \rightarrow X \rightarrow Y[1]$. Then we have $\chi(X)\chi(Y) = \chi(B) + \chi(B')$.

The last condition is needed to ensure that indecomposable rigid objects are sent to cluster variables (see also [17]).

There are several interesting generalizations beyond the acyclic case, and we refer to ([37],[52],[56],[57],[58],[93],[96],[97]).

Acknowledgement

I want to express my gratitude to Aslak Bakke Buan, Osamu Iyama, Bernhard Keller and Robert Marsh for helpful comments and suggestions, and I would like to thank them and my other coauthors on the topic of this paper for enjoyable collaboration.

References

- [1] C. Amiot, *Cluster categories for algebras of global dimension 2 and quivers with potential*, Annales de l'institut Fourier **59** (2009), no. 6, 2525–2590.
- [2] C. Amiot, O. Iyama, and I. Reiten, *Stable categories of Cohen-Macaulay modules and cluster categories*, in preparation.
- [3] C. Amiot, O. Iyama, I. Reiten, and G. Todorov, *Preprojective algebras and c-sortable words*, arXiv: 1002.4131.
- [4] C. Amiot, I. Reiten, and G. Todorov, *The ubiquity of generalized cluster categories*, arXiv:1002.4131, Adv. Math., to appear.
- [5] I. Assem, T. Brüstle, and R. Schiffler, *Cluster-tilted algebras as trivial extensions*, Bull. London Math. Soc. **40** (2008), 151–162.
- [6] I. Assem, D. Simson, and A. Skowroński, *Elements of the representation theory of associative algebras*, vol. 65, Cambridge University Press, Cambridge, 2006.
- [7] M. Auslander, *Functors and morphisms determined by objects in: Representation theory of algebras*, Lecture Notes in Pure and Appl. Math. **37** (1978), 1–24.
- [8] M. Auslander, M. I. Platzzeck, and I. Reiten, *Coxeter functors without diagrams*, Trans. Amer. Math. Soc. **250** (1979), 1–46.

- [9] M. Auslander and I. Reiten, *Representation theory of artin algebras III. Almost split sequences*, *Comm. Alg.* **3** (1975), no. 3, 239–294.
- [10] M. Auslander, I. Reiten, and S. O. Smalø, *Representation theory of artin algebras*, vol. 36, Cambridge University Press, 1995.
- [11] M. Barot, D. Kussin, and H. Lenzing, *The cluster category of a canonical algebra*, *Trans.Amer.Math.Soc.* **362** (2010), 4313–4330.
- [12] K. Baur and R. Marsh, *A geometric description of the m -cluster categories of type D_n* , *Int. Math. Res. Not. IMRN* (2007), no. 4.
- [13] C.E.Beasley and M.R. Plesser, *Toric duality is Seiberg duality*, *J. High Energy Phys.* **38** (2001), no. 12, Paper 1, hep-th/0109053.
- [14] A. Berenstein, S. Fomin, and A. Zelevinsky, *Cluster algebras III. Upper bounds and double Bruhat cells*, *Duke Math. J.* **126** (2005), no. 1, 1–52.
- [15] I. N. Bernšteĭn, I. M. Gel'fand, and V. A. Ponomarev, *Coxeter functors and Gabriel's theorem*, *Uspekhi Mat.Nauk* **170** (1973), no. 2, 19–33.
- [16] S. Brenner and M. C. R. Butler, *Generalizations of the Bernstein-Gelfand-Ponomarev reflection functors*, *Representation theory II*, *Lecture Notes in Math.* **832** (1980), 103–169.
- [17] A. B. Buan, O. Iyama, I. Reiten, and J. Scott, *Cluster structures for 2-Calabi-Yau categories and unipotent groups*, *Compos. Math.* **145** (2009), no. 4, 1035–1079.
- [18] A. B. Buan, O. Iyama, I. Reiten, and D. Smith, *Mutation of cluster-tilting objects and potentials*, arXiv:0804.3813, to appear in *Amer. J. Math.*
- [19] A. B. Buan and R. J. Marsh, *Cluster-tilting theory*, *Contemp. Math.*, Providence, RI **406** (2006), pp. 1–30.
- [20] A. B. Buan, R. J. Marsh, M. Reineke, I. Reiten, and G. Todorov, *Tilting theory and cluster combinatorics*, *Adv. Math.* **204** (2006), no. 2, 572–618.
- [21] A. B. Buan, R. Marsh, and I. Reiten, *Cluster-tilted algebras of finite representation type*, *J. Algebra* **306** (2006), no. 2, 412–431.
- [22] ———, *Denominators of cluster variables*, *J. Lond. Math. Soc. (2)* **79** (2006), no. 3, 589–611.
- [23] ———, *Cluster-tilted algebras*, *Trans. Amer. Math. Soc.* **359** (2007), no. 1, 323–332.
- [24] ———, *Cluster mutation via quiver representations*, *Comment. Math. Helv.* **83** (2008), no. 1, 143–177.
- [25] A. B. Buan, R. J. Marsh, I. Reiten, and G. Todorov, *Clusters and seeds in acyclic cluster algebras*, *Proc. Amer. Math. Soc.* **135** (2007), no. 10, 3049–3060 (electronic). With an appendix coauthored in addition by P. Caldero and B. Keller.
- [26] A. B. Buan and I. Reiten, *From tilted to cluster-tilted algebras of Dynkin type*, arXiv:math. RT/0510445.
- [27] ———, *Acyclic quivers of finite mutation type*, *IMRN Art. ID 12804* (2006), 1–10.

- [28] A. B. Buan, I. Reiten, and A. Seven, *Tame concealed algebras and minimal infinite cluster algebras*, Journal of Pure and Applied Algebra **211** (2007), no. 1, 71–82.
- [29] A. B. Buan and H. Thomas, *Coloured quiver mutation for higher cluster categories*, Adv. Math. vol **222** (3)(2009), 971–995.
- [30] I. Burban, O. Iyama, B. Keller, and I. Reiten, *Cluster tilting for one-dimensional hypersurface singularities*, Adv. Math. (2008), no. 6, 2443–2484.
- [31] P. Caldero and F. Chapoton, *Cluster algebras as Hall algebras of quiver representations*, Comment. Math. Helv. **81** (2006), no. 3, 595–616.
- [32] P. Caldero, F. Chapoton, and R. Schiffler, *Quivers with relations and cluster tilted algebras*, Algebr. Represent. Theory **9** (2006), no. 4, 359–376.
- [33] ———, *Quivers with relations arising from clusters (A_n case)*, Trans. Amer. Math. Soc. **358** (2006), no. 5, 1347–1364.
- [34] P. Caldero and B. Keller, *From triangulated categories to cluster algebras II*, Ann. Sci. École Norm. Sup. (4) **39** (2006), no. 6, 983–1009.
- [35] ———, *From triangulated categories to cluster algebras*, Inv. Math. **172** (2008), 169–211.
- [36] P. Caldero and M. Reineke, *On the quiver Grassmannian in the acyclic case*, J. Pure Appl. Algebra **212** (2008), no. 11, 2369–2380.
- [37] R. Dehy and B. Keller, *On the combinatorics of rigid objects in 2-Calabi-Yau categories*, IMRN **11** (2008), Art.ID rnn029.
- [38] L. De Völcese and M. Van den Bergh, *Explicit modules for some stable categories of maximal Cohen-Macaulay modules*, in preparation.
- [39] H. Derksen, J. Weyman, and A. Zelevinsky, *Quivers with potentials and their representations I: Mutations*, Selecta Mathematica **14** (2008), 59–119.
- [40] ———, *Quivers with potentials and their representations II: Applications to cluster algebras*, J. Amer. Math. Soc. **23** (2010), no. 3, 749–790.
- [41] A. Felikson, M. Shapiro, and P. Tumarkin, *Skew-symmetric cluster algebras of finite mutation type*, arXiv:0811.1703.
- [42] V. Fock and A. Goncharov, *Moduli spaces of local systems and higher Teichmüller theory*, Publ. Math. Inst. Hautes Études Sci. **103** (2006), 1–211.
- [43] ———, *Dual Teichmüller and lamination spaces*, Handbook of Teichmüller theory. Vol. I, 647–684, IRMA Lect. Math. Theor. Phys. Vol.11, 2007.
- [44] ———, *Cluster ensembles, quantization and the dilogarithm*, Ann. Sci. Éc. Normal Supér (4) **42** (2009), no. 6, 865–930.
- [45] S. Fomin, *Total positivity and cluster algebras*, Proc. ICM, 2010.
- [46] S. Fomin and N. Reading, *Generalized cluster complexes and Coxeter combinatorics*, Int. Math. Res. Not. 2005, no. 44, 2709–2757.
- [47] S. Fomin and D. Thurston, *Cluster algebras and triangulated surfaces. Part II: Lambda lengths*, preprint, 2008.

-
- [48] S. Fomin and A. Zelevinsky, *Cluster algebras I. Foundations*, J. Amer. Math. Soc. **15** (2002), no. 2, 497–529 (electronic).
- [49] ———, *Cluster algebras II. Finite type classification*, Invent. Math. **154** (2003), no. 2, 63–121.
- [50] ———, *Y-systems and generalized associahedra*, Ann. of Math. **158** (2003), no. 3, 977–1018.
- [51] ———, *Cluster algebras IV: Coefficients*, Compos. Math. **143** (2007), no. 3, 112–164.
- [52] C. Fu and B. Keller, *On cluster algebras with coefficients and 2-Calabi-Yau categories*, Trans. Amer. Math. Soc. **362** (2010), 859–895.
- [53] P. Gabriel, *Unzerlegbare Darstellungen I*, Manuscripta Math. **6** (1972), 71–103.
- [54] P. Gabriel and A. V. Roiter, *Representations of finite-dimensional algebras*, with a chapter by B. Keller, Encyclopedia Math. Sci. **73**, Algebra VIII, 1–177, Springer 1992.
- [55] C. Geiss, B. Leclerc, and J. Schröer, *Cluster algebra structures and semicanonical bases for unipotent groups*, arXiv:math/0703039.
- [56] ———, *Kac-Moody groups and cluster algebras*, arXiv 1001.3545.
- [57] ———, *Rigid modules over preprojective algebras*, Invent. Math. **165** (2006), no. 3, 589–632.
- [58] ———, *Semicanonical bases and preprojective algebras II. A multiplication formula*, Compos. Math. **143** (2007), no. 5, 1313–1334.
- [59] ———, *Partial flag varieties and preprojective algebras*, Ann. Inst. Fourier (Grenoble) **58** (2008), no. 3, 825–876.
- [60] M. Gekhtman, M. Shapiro, and A. Vainshtein, *On the properties of the exchange graph of a cluster algebra*, Math.CO/0703151.
- [61] ———, *Cluster algebras and Poisson geometry*, Mosc. Math. J. **3** (2003), no. 3, 899–934, 1199.
- [62] ———, *Cluster algebras and Weil-Petersson forms*, Duke Math. J. **127** (2005), no. 2, 291–311.
- [63] V. Ginzburg, *Calabi-Yau algebras*, arXiv:math/0612139v3 [math.AG].
- [64] D. Happel, *Triangulated categories in the representation of finite dimensional algebras*, Cambridge Univ. Press, Cambridge, 1988.
- [65] ———, *Auslander-Reiten triangles in derived categories of finite-dimensional algebras*, Proc. Amer. Math. Soc. **112** (1991), no. 3, 641–648.
- [66] D. Happel, I. Reiten, and S. O. Smalø, *Tilting in abelian categories and quasi-tilted algebras*, Memoirs AMS, **120** (1996), no. 575, viii+88.
- [67] D. Happel and C. M. Ringel, *Tilted algebras*, Trans. Amer. Math. Soc. **274** (1982), no. 2, 399–443.
- [68] D. Happel and L. Unger, *Almost complete tilting modules*, Proc. Amer. Math. Soc. **107** (1989), no. 3, 603–610.

- [69] ———, *On the set of tilting objects in hereditary categories*. *Representations of algebras and related topics*, Fields Inst. Commun. **45** (2005), 141–159.
- [70] D. Hernandez and B. Leclerc, *Cluster algebras and quantum affine algebras*, arXiv:0903.1452v1 [math.QA].
- [71] A. Hubery, *Acyclic cluster algebras via Ringel-Hall algebras*, preprint, at author's homepage.
- [72] ———, *The cluster complex of a hereditary artin algebra*, arXiv:0812.1475 [math.RT], *Algebras and Representation Theory* (to appear).
- [73] R. Inoue, O. Iyama, A. Kuniba, T. Nakanishi, and J. Suzuki, *Periodicities of T -systems and Y -systems*, Nagoya Mat. J. **197** (2010), no. 1, 59–174.
- [74] O. Iyama, *Higher Auslander-Reiten theory and maximal orthogonal subcategories*, Adv. Math. **210** (2007), 22–50.
- [75] ———, *Auslander correspondence*, Adv. Math. **210** (2007), 51–81.
- [76] O. Iyama and I. Reiten, *2-Auslander algebras associated with reduced words in Coxeter groups*, arXiv:1002.3247 IMRN (to appear).
- [77] ———, *Fomin-Zelevinsky mutation and tilting modules over Calabi-Yau algebras*, Amer. J. Math. **130** (2008), no. 8, 1087–1149.
- [78] O. Iyama and Y. Yoshino, *Mutations in triangulated categories and rigid Cohen-Macaulay modules*, Inv. Math. **172** (2008), 117–168.
- [79] B. Keller, *On triangulated orbit categories*, Doc. Math. **10** (2005), 551–581.
- [80] ———, *Categorification of acyclic cluster algebras: an introduction*, arXiv0801.3103.
- [81] ———, *Cluster-algebras, quiver representations and triangulated categories*, arXiv08.07.1960. Proc. Workshop on Triangulated Categories (Leeds 2006).
- [82] ———, *Calabi-Yau triangulated categories*, EMS Ser. Congr. Repr. Math. Soc. Zürich (2008), 467–489.
- [83] ———, *Algèbres amassées et applications*, Seminaire Bourbaki, Exposé **1014** (2009), no. 6, 27p.
- [84] ———, *Deformed Calabi-Yau completions*, arXiv:0908.3499 [math.RT] (to appear in Crelle's Journal).
- [85] B. Keller and I. Reiten, *Cluster-tilted algebras are Gorenstein and stably Calabi-Yau*, Adv. Math. **211** (2007), 123–151.
- [86] ———, *Acyclic Calabi-Yau categories are cluster categories*, with an appendix by Michel Van den Bergh, Comp. Math. Vol. **144**, issue 05 (2008), 1332–1342.
- [87] B. Keller and D. Yang, *Derived equivalences from mutations of quivers with potential*, arXiv:0906.0761.
- [88] H. Knörrer, *Cohen-Macaulay modules on hypersurface singularities*, Inv. Math. **88** (1987), 153–164.
- [89] M. Kontsevich and Y. Soibelman, *Stability structures, Donaldson-Thomas invariants and cluster transformations*, arXiv:0811.2435.
- [90] K. Kurano and S. Nishi, *Gorenstein isolated quotient singularities of odd prime dimension are cyclic*, arXiv: 1004.4171.

- [91] B. Leclerc, *Cluster algebras and representation theory*, Proc. ICM, 2010.
- [92] R. Marsh, M. Reineke, and A. Zelevinsky, *Generalized associahedra via quiver representations*, Trans. Amer. Math. Soc. **355**, no. 10, 4171–4186 (electronic).
- [93] K. Nagao, *Donaldson-Thomas theory and cluster algebras*, arXiv: 1002.4956.
- [94] H. Nakajima, *Quiver varieties and cluster algebras*, arXiv:0905.0002v3 [math.QA].
- [95] Y. Palu, *Cluster characters for 2-Calabi-Yau triangulated categories*, Ann. Inst. Fourier **58**, no. 6, 2221–2248.
- [96] P. G. Plamondon, *Cluster characters for cluster categories with infinite-dimensional morphism spaces*, arXiv: 1002.4956.
- [97] ———, *Cluster algebras via cluster categories with infinite dimensional morphism spaces*, arXiv: 1004.0830 [math. RA].
- [98] F. Qin, *Quantum cluster variable via Serre polynomials*, arXiv: 1004.4171.
- [99] I. Reiten, *Tilting theory and cluster algebras*, preprint available at www.institut.math.jussieu.fr/~keller/ictp2006/lecturenotes/reiten.pdf, Trieste lectures in representation theory, 2006.
- [100] ———, *2-CY-tilted algebras*, Sao Paulo J. of Math. Sciences, Proc. ICRA **12** (2008).
- [101] I. Reiten and G. Todorov, unpublished.
- [102] C. Riedtmann and A. Schofield, *On open orbits and their complements*, J. Algebra **130** (1990), no. 2, 388–411.
- [103] C. M. Ringel, *Tame algebras and integral quadratic forms*, vol. 1099, Springer-Verlag, Berlin, 1984.
- [104] ———, *Some remarks concerning tilting modules and tilted algebras. Origin. Relevance. Future.*, Handbook of Tilting Theory, LMS Lecture Note Series **332** (2007), pp. 49–104.
- [105] R. Schiffler, *A geometric model for cluster categories of type D_n* , Alg. Comb. **27** (2008), no. 1, 1–21.
- [106] J. S. Scott, *Grassmannians and cluster algebras*, Proc. London Math. Soc. **92** (2006), no. 3, 345–380.
- [107] N. Seiberg, *Electric-magnetic duality in supersymmetric non-abelian gauge theories*, Nuclear Phys. B **435** (1995), no. 1–2, 129–146.
- [108] Ø. Solberg, *Hypersurface singularities of finite Cohen-Macaulay type*, Proc. London Math. Soc. **58** (1989), 258–280.
- [109] H. Thomas, *Defining an m -cluster category*, J. Algebra **318** (2007), no. 1, 37–76.
- [110] L. Unger, *Schur modules over wild, finite dimensional path algebras with three simple modules*, J. Pure Appl. Algebra **64** (1990), no. 2, 205–222.
- [111] A. Wraalsen, *Rigid objects in higher cluster categories*, J. Algebra **321** (2009), no. 2, 532–547.
- [112] A. Zelevinsky, *What is ... a Cluster Algebra*, Notices of the AMS **54** (2007), no. 11, 1494–14–95.

- [113] Y. Zhou and B. Zhu, *Cluster combinatorics and d -cluster categories*, J. Algebra **321** (2009), no. 10.
- [114] B. Zhu, *Equivalences between cluster categories*, J. Algebra **304** (2006), no. 2, 832–850.
- [115] B. Zhu, *Generalized cluster complexes via quiver representations*, J. Algebraic Combin. **27** (2008), no. 1, 35–54.

Discrete Complex Analysis and Probability

Stanislav Smirnov*

Abstract

We discuss possible discretizations of complex analysis and some of their applications to probability and mathematical physics, following our recent work with Dmitry Chelkak, Hugo Duminil-Copin and Clément Hongler.

Mathematics Subject Classification (2010). Primary 30G25; Secondary 05C81, 60K35, 81T40, 82B20.

Keywords. Discrete complex analysis, discrete analytic function, Ising model, self-avoiding walk, conformal invariance

1. Introduction

The goal of this note is to discuss some of the applications of discrete complex analysis to problems in probability and statistical physics. It is not an exhaustive survey, and it lacks many references. Forgoing completeness, we try to give a taste of the subject through examples, concentrating on a few of our recent papers with Dmitry Chelkak, Hugo Duminil-Copin and Clément Hongler [CS08, CS09, CS10, DCS10, HS10]. There are certainly other interesting developments in discrete complex analysis, and it would be a worthy goal to write an extensive exposition with an all-encompassing bibliography, which we do not attempt here for lack of space.

Complex analysis (we restrict ourselves to the case of one complex or equivalently two real dimensions) studies analytic functions on (subdomains of) the complex plane, or more generally analytic structures on two dimensional manifolds. Several things are special about the (real) dimension two, and we won't

*This research was supported by the European Research Council AG "CONFRA" and by the Swiss National Science Foundation. We would like to thank Dmitry Chelkak for comments on the preliminary version of this paper.

Section de Mathématiques, Université de Genève. 2-4 rue du Lièvre, CP 64, 1211 Genève 4, SUISSE. E-mail: stanislav.smirnov@unige.ch

discuss an interesting and often debated question, why exactly complex analysis is so nice and elegant. In particular, several definitions lead to identical class of analytic functions, and historically different adjectives (regular, analytic, holomorphic, monogenic) were used, depending on the context. For example, an *analytic* function has a local power series expansion around every point, while a *holomorphic* function has a complex derivative at every point. Equivalence of these definitions is a major theorem in complex analysis, and there are many other equivalent definitions in terms of Cauchy-Riemann equations, contour integrals, primitive functions, hydrodynamic interpretation, etc. Holomorphic functions have many nice properties, and hundreds of books were devoted to their study.

Consider now a discretized version of the complex plane: some graph embedded into it, say a square or triangular lattice (more generally one can speak of discretizations of Riemann surfaces). Can one define analytic functions on such a graph? Some of the definitions do not admit a straightforward discretization: e.g. local power series expansions do not make sense on a lattice, so we cannot really speak of discrete analyticity. On the other hand, as soon as we define discrete derivatives, we can ask for the holomorphicity condition. Thus it is philosophically more correct to speak of *discrete holomorphic*, rather than discrete analytic functions. We will use the term *preholomorphic* introduced by Ferrand [Fer44], as we prefer it to the term *monodiffic* used by Isaacs in the original papers [Isa41, Isa52] (a play on the term monogenic used by Cauchy for continuous analytic functions).

Though the preholomorphic functions are easy to define, there is a lack of expository literature about them. We see two main reasons: firstly, there is no canonical preholomorphicity definition, and one can argue which of the competing approaches is better (the answer probably depends on potential applications). Secondly, it is straightforward to transfer to the discrete case beginnings of the usual complex analysis (a nice topic for an undergraduate research project), but the easy life ends when it becomes necessary to multiply preholomorphic functions. There is no easy and natural way to proceed and the difficulty is addressed depending on the problem at hand.

As there seems to be no canonical discretization of the complex analysis, we would rather adopt a utilitarian approach, working with definitions corresponding to interesting objects of probabilistic origin, and allowing for a passage to the scaling limit. We want to emphasize, that we are concerned with the following triplets:

1. A planar graph,
2. Its embedding into the complex plane,
3. Discrete Cauchy-Riemann equations.

We are interested in triplets such that the discrete complex analysis approximates the continuous one. Note that one can start with only a few elements of

the triplet, which gives some freedom. For example, given an embedded graph, one can ask which discrete difference equations have solutions close to holomorphic functions. Or, given a planar graph and a notion of preholomorphicity, one can look for an appropriate embedding.

The ultimate goal is to find lattice models of statistical physics with preholomorphic observables. Since those observables would approximate holomorphic functions, some information about the original model could be subsequently deduced.

Below we start with several possible definitions of the preholomorphic functions along with historical remarks. Then we discuss some of their recent applications in probability and statistical physics.

2. Discrete Holomorphic Functions

For a given planar graph, there are several ways to define *preholomorphic* functions, and it is not always clear which way is preferable. A much better known class is that of *discrete harmonic* (or *preharmonic*) functions, which can be defined on any graph (not necessarily planar), and also in more than one way. However, one definition stands out as the simplest: a function on the vertices of graph is said to be *preharmonic* at a vertex v , if its discrete Laplacian vanishes:

$$0 = \Delta H(u) := \sum_{v: \text{neighbor of } u} (H(v) - H(u)) . \quad (1)$$

More generally, one can put weights on the edges, which would amount to taking different resistances in the electric interpretation below. Preharmonic functions on planar graphs are closely related to discrete holomorphicity: for example, their gradients defined on the oriented edges by

$$F(\vec{uv}) := H(v) - H(u) , \quad (2)$$

are preholomorphic. Note that the edge function above is antisymmetric, i.e. $F(\vec{uv}) = -F(\vec{vu})$.

Both classes with the definitions as above are implicit already in the 1847 work of Kirchhoff [Kir47], who interpreted a function defined on oriented edges as an electric current flowing through the graph. If we assume that all edges have unit resistance, then the sum of currents flowing from a vertex is zero by the first Kirchhoff law:

$$\sum_{u: \text{neighbor of } v} F(\vec{uv}) = 0 , \quad (3)$$

and the sum of the currents around any oriented closed contour γ (for the planar graphs it is sufficient to consider contours around faces) face is zero by the second Kirchhoff law:

$$\sum_{\vec{uv} \in \gamma} F(\vec{uv}) = 0 . \quad (4)$$

The two laws are equivalent to saying that F is given by the gradient of a potential function H as in (2), and the latter function is preharmonic (1). One can equivalently think of a hydrodynamic interpretation, with F representing the flow of liquid. Then conditions (3) and (4) mean that the flow is divergence- and curl-free correspondingly. Note that in the continuous setting similarly defined gradients of harmonic functions on planar domains coincide up to complex conjugation with holomorphic functions. And in higher dimensions harmonic gradients were proposed as one of their possible generalizations.

There are many other ways to introduce discrete structures on graphs, which can be developed in parallel to the usual complex analysis. We have in mind mostly such discretizations that restrictions of holomorphic (or harmonic) functions become *approximately* preholomorphic (or preharmonic). Thus we speak about graphs embedded into the complex plane or a Riemann surface, and the choice of embedding plays an important role. Moreover, the applications we are after require passages to the scaling limit (as mesh of the lattice tends to zero), so we want to deal with discrete structures which converge to the usual complex analysis as we take finer and finer graphs.

Preharmonic functions satisfying (1) on the square lattices with decreasing mesh fit well into this philosophy, and were studied in a number of papers in early twentieth century (see e.g. [PW23, Bou26, Lus26]), culminating in the seminal work of Courant, Friedrichs and Lewy. It was shown in [CFL28] that solution to the Dirichlet problem for a discretization of an elliptic operator converges to the solution of the analogous continuous problem as the mesh of the lattice tends to zero. In particular, a preharmonic function with given boundary values converges in the scaling limit to a harmonic function with the same boundary values in a rather strong sense, including convergence of all partial derivatives.

Preholomorphic functions distinctively appeared for the first time in the papers [Isa41, Isa52] of Isaacs, where he proposed two definitions (and called such functions “monodiffic”). A few papers of his and others followed, studying the first definition (5), which is asymmetric on the square lattice. More recently the first definition was studied by Dynnikov and Novikov [DN03] in the triangular lattice context, where it becomes symmetric (the triangular lattice is obtained from the square lattice by adding all the diagonals in one direction).

The second, symmetric, definition was reintroduced by Ferrand, who also discussed the passage to the scaling limit [Fer44, LF55]. This was followed by extensive studies of Duffin and others, starting with [Duf56].

Both definitions ask for a discrete version of the Cauchy-Riemann equations $\partial_{i\alpha}F = i\partial_{\alpha}F$ or equivalently that z -derivative is independent of direction. Consider a subregion Ω_ϵ of the mesh ϵ square lattice $\epsilon\mathbb{Z}^2 \subset \mathbb{C}$ and define a function on its vertices. Isaacs proposed the following two definitions, replacing the derivatives by discrete differences. His “monodiffic functions of the first kind” are required to satisfy inside Ω_ϵ the following identity:

$$F(z + i\epsilon) - F(z) = i(F(z + \epsilon) - F(z)) \quad , \quad (5)$$

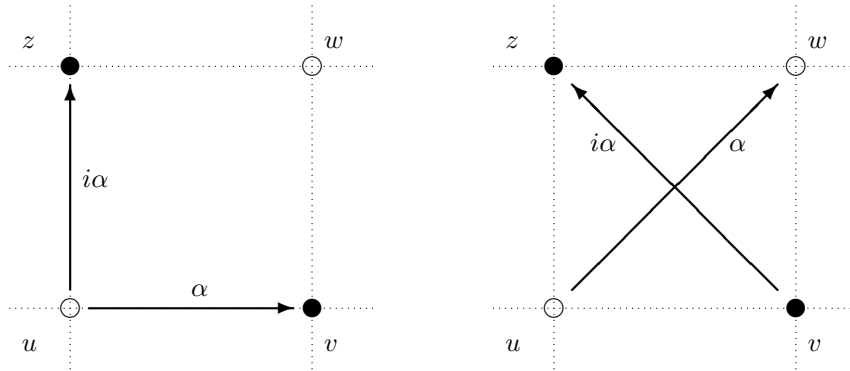

Figure 1. The first and the second Isaacs’ definitions of discrete holomorphic functions: multiplied by i difference along the vector α is equal to the difference along the rotated vector $i\alpha$. Note that the second definition (on the right) is symmetric with respect to lattice rotations, while the first one is not.

which can be rewritten as

$$\frac{F(z + i\epsilon) - F(z)}{(z + i\epsilon) - z} = \frac{F(z + \epsilon) - F(z)}{(z + \epsilon) - z} .$$

We will be working with his second definition, which is more symmetric and also appears naturally in probabilistic context (but otherwise the theories based on two definitions are almost the same). We say that a function is *preholomorphic*, if inside Ω_ϵ it satisfies the following identity, illustrated in Figure 1:

$$F(z + i\epsilon) - F(z + \epsilon) = i(F(z + \epsilon(1 + i)) - F(z)) , \tag{6}$$

which can also be rewritten as

$$\frac{F(z + i\epsilon) - F(z + \epsilon)}{(z + i\epsilon) - (z + \epsilon)} = \frac{F(z + \epsilon(1 + i)) - F(z)}{(z + \epsilon(1 + i)) - z} .$$

It is easy to see that restrictions of continuous holomorphic functions to the mesh ϵ square lattice satisfy this identity up to $O(\epsilon^3)$. Note also that if we color the lattice in the chess-board fashion, the complex identity (6) can be written as two real identities (its real and imaginary parts), one involving the real part of F at black vertices and the imaginary part of F at white vertices, the other one – vice versa. So unless we have special boundary conditions, F splits into two “demi-functions” (real at white and imaginary at black vs. imaginary at black and real at white vertices), and some prefer to consider just one of those, i.e. ask F to be purely real at black vertices and purely imaginary at white ones.

The theory of so defined preholomorphic functions starts much like the usual complex analysis. It is easy to check, that for preholomorphic functions sums are also preholomorphic, discrete contour integrals vanish, primitive (in

a simply-connected domain) and derivative are well-defined and are preholomorphic functions on the dual square lattice, real and imaginary parts are preharmonic on their respective black and white sublattices, etc. Unfortunately, the product of two preholomorphic functions is no longer preholomorphic: e.g., while restrictions of 1 , z , and z^2 to the square lattice are preholomorphic, the higher powers are only approximately so.

Situation with other possible definitions is similar, with much of the linear complex analysis being easy to reproduce, and problems appearing when one has to multiply preholomorphic functions. Pointwise multiplication cannot be consistently defined, and though one can introduce convolution-type multiplication, the possible constructions are non-local and cumbersome. Sometimes, for different graphs and definitions, problems appear even earlier, with the first derivative not being preholomorphic.

Our main reason for choosing the definition (6) is that it naturally appears in probabilistic context. It was also noticed by Duffin that (6) nicely generalizes to a larger family of *rhombic lattices*, where all the faces are rhombi. Equivalently, one can speak of *isoradial graphs*, where all faces are inscribed into circles of the same radius — an isoradial graph together with its dual forms a rhombic lattice.

There are two main reasons to study this particular family. First, this is perhaps the largest family of graphs for which the Cauchy-Riemann operator admits a nice discretization. Indeed, restrictions of holomorphic functions to such graphs are preholomorphic to higher orders. This was the reason for the introduction of complex analysis on rhombic lattices by Duffin [Duf68] in late sixties. More recently, the complex analysis on such graphs was studied for the sake of probabilistic applications [Mer01, Ken02, CS08].

On the other hand, this seems to be the largest family where certain lattice models, including the Ising model, have nice integrability properties. In particular, the critical point can be defined with weights depending only on the local structure, and the star-triangle relation works out nicely. It seems that the first appearance of related family of graphs in the probabilistic context was in the work of Baxter [Bax78], where the eight vertex and Ising models were considered on Z -invariant graphs, arising from planar line arrangements. These graphs are topologically the same as the isoradial ones, and though they are embedded differently into the plane, by [KS05] they always admit isoradial embeddings. In [Bax78] Baxter was not passing to the scaling limit, and so the actual choice of embedding was immaterial for his results. However, his choice of weights in the models would suggest an isoradial embedding, and the Ising model was so considered by Mercat [Mer01], Boutilier and de Tilière [BdT08, BdT09], Chelkak and the author [CS09]. Additionally, the dimer and the uniform spanning tree models on such graphs also have nice properties, see e.g. [Ken02].

We would also like to remark that rhombic lattices form a rather large family of graphs. While not every topological quadrangulation (graph all of whose faces

are quadrangles) admits a rhombic embedding, Kenyon and Schlenker [KS05] gave a simple topological condition necessary and sufficient for its existence.

So this seems to be the most general family of graphs appropriate for our subject, and most of what we discuss below generalizes to it (though for simplicity we speak of the square and hexagonal lattices only).

3. Applications of Preholomorphic Functions

Besides being interesting in themselves, preholomorphic functions found several diverse applications in combinatorics, analysis, geometry, probability and physics.

After the original work of Kirchhoff, the first notable application was perhaps the famous article [BSST40] of Brooks, Smith, Stone and Tutte, who used preholomorphic functions to construct tilings of rectangles by squares.

Several applications to analysis followed, starting with a new proof of the Riemann uniformization theorem by Ferrand [LF55]. Solving the discrete version of the usual minimization problem, it is immediate to establish the existence of the minimizer and its properties, and then one shows that it has a scaling limit, which is the desired uniformization. Duffin and his co-authors found a number of similar applications, including construction of the Bergman kernel by Dieter and Mastin [DM71]. There were also studies of discrete versions of the multi-dimensional complex analysis, see e.g. Kiselman's [Kis05].

In [Thu86] Thurston proposed *circle packings* as another discretization of complex analysis. They found some beautiful applications, including yet another proof of the Riemann uniformization theorem by Rodin and Sullivan [RS87]. More interestingly, they were used by He and Schramm [HS93] in the best result so far on the Koebe uniformization conjecture, stating that any domain can be conformally uniformized to a domain bounded by circles and points. In particular, they established the conjecture for domains with countably many boundary components. More about circle packings can be learned from Stephenson's book [Ste05]. Note that unlike the discretizations discussed above, the circle packings lead to non-linear versions of the Cauchy-Riemann equations, see e.g. the discussion in [BMS05].

There are other interesting applications to geometry, analysis, combinatorics, probability, and we refer the interested reader to the expositions by Lovász [Lov04], Stephenson [Ste05], Mercat [Mer07], Bobenko and Suris [BS08].

In this note we are interested in applications to probability and statistical physics. Already the Kirchhoff's paper [Kir47] makes connection between the Uniform Spanning Tree and preharmonic (and so preholomorphic) functions.

Connection of Random Walk to preharmonic functions was certainly known to many researchers in early twentieth century, and figured implicitly in many papers. It is explicitly discussed by Courant, Friedrichs and Lewy in [CFL28], with preharmonic functions appearing as Green's functions and exit probabilities for the Random Walk.

More recently, Kenyon found preholomorphic functions in the dimer model (and in the Uniform Spanning Tree in a way different from the original considerations of Kirchhoff). He was able to obtain many beautiful results about statistics of the dimer tilings, and in particular, showed that those have a conformally invariant scaling limit, described by the Gaussian Free Field, see [Ken00, Ken01]. More about Kenyon's results can be found in his expositions [Ken04, Ken09]. An approximately preholomorphic function was found by the author in the critical site percolation on the triangular lattice, allowing to prove the Cardy's formula for crossing probabilities [Smi01b, Smi01a].

Finally, we remark that various other discrete relations were observed in many integrable two dimensional models of statistical physics, but usually no explicit connection was made with complex analysis, and no scaling limit was considered. Here we are interested in applications of integrability parallel to that for the Random Walk and the dimer model above. Namely, once a preholomorphic function is observed in some probabilistic model, we can pass to the scaling limit, obtaining a holomorphic function. Thus, the preholomorphic observable is approximately equal to the limiting holomorphic function, providing some knowledge about the model at hand. Below we discuss applications of this philosophy, starting with the Ising model.

4. The Ising Model

In this Section we discuss some of the ways how preholomorphic functions appear in the Ising model at criticality. The observable below was proposed in [Smi06] for the hexagonal lattice, along with a possible generalization to $O(N)$ model. Similar objects appeared earlier in Kadanoff and Ceva [KC71] and in Mercat [Mer01], though boundary values and conformal covariance, which are central to us, were never discussed.

The scaling limit and properties of our observable on isoradial graphs were worked out by Chelkak and the author in [CS09]. It is more appropriate to consider it as a *fermion* or a *spinor*, by writing $F(z)\sqrt{dz}$, and with more general setup one has to proceed in this way.

Earlier we constructed a similar fermion for the random cluster representation of the Ising model, see [Smi06, Smi10] and our joint work with Chelkak [CS09] for generalization to isoradial graphs (and also independent work of Riva and Cardy [RC06] for its physical connections). It has a simpler probabilistic interpretation than the fermion in the spin representation, as it can be written as the probability of the interface between two marked boundary points passing through a point inside, corrected by a complex weight depending on the winding.

The fermion for the spin representation is more difficult to construct. Below we describe it in terms of contour collections with distinguished points. Alternatively it corresponds to the partition function of the Ising model with a \sqrt{z}

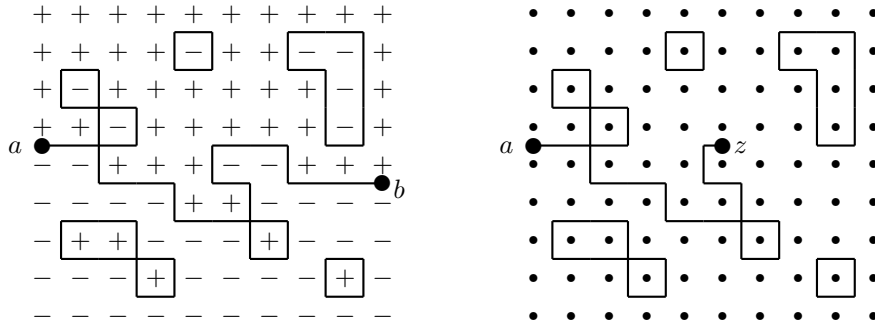

Figure 2. Left: configuration of spins in the Ising model with Dobrushin boundary conditions, its contour representation, and an interface between two boundary points. Right: an example of a configuration considered for the Fermionic observable: a number of loops and a contour connecting a to z . It can be represented as a spin configuration with a monodromy at z .

monodromy at a given edge, corrected by a complex weight; or to a product of order and disorder operators at neighboring site and dual site.

We will consider the Ising model on the mesh ϵ square lattice. Let Ω_ϵ be a discretization of some bounded domain $\Omega \subset \mathbb{C}$. The Ising model on Ω_ϵ has configurations σ which assign ± 1 (or simply \pm) spins $\sigma(v)$ to vertices $v \in \Omega_\epsilon$ and Hamiltonian defined (in the absence of an external magnetic field) by

$$H(\sigma) = - \sum_{\langle u,v \rangle} \sigma(u)\sigma(v) ,$$

where the sum is taken over all edges $\langle u,v \rangle$ inside Ω_ϵ . Then the partition function is given by

$$Z = \sum_{\sigma} \exp(-\beta H(\sigma)) ,$$

and probability of a given spin configuration becomes

$$\mathbb{P}(\sigma) = \exp(-\beta H(\sigma)) / Z .$$

Here $\beta \geq 0$ is the temperature parameter (behaving like the reciprocal of the actual temperature), and Kramers and Wannier have established [KW41] that its critical value is given by $\beta_c = \log(\sqrt{2} + 1) / 2$.

Now represent the spin configurations graphically by a collection of interfaces – contours on the dual lattice, separating plus spins from minus spins, the so-called *low-temperature expansion*, see Figure 2. A contour collection is a set of edges, such that an even number emanates from every vertex. In such case the contours can be represented as a union of loops (possibly in a non-unique way, but we do not distinguish between different representations). Note

that each contour collection corresponds to two spin collections which are negatives of each other, or to one if we fix the spin value at some vertex. The partition function of the Ising model can be rewritten in terms of the contour configurations ω as

$$Z = \sum_{\omega} x^{\text{length of contours}} .$$

Each neighboring pair of opposite spins contributes an edge to the contours, and so a factor of $x = \exp(-2\beta)$ to the partition function. Note that the critical value is $x_c = \exp(-2\beta_c) = \sqrt{2} - 1$.

We now want to define a preholomorphic observable. To this effect we need to distinguish at least one point (so that the domain has a non-trivial conformal modulus). One of the possible applications lies in relating interfaces to Schramm's SLE curves, in the simplest setup running between two boundary points. To obtain a discrete interface between two boundary points a and b , we introduce Dobrushin boundary conditions: $+$ on one boundary arc and $-$ on another, see Figure 2. Then those become unique points with an odd number of contour edges emanating from them.

Now to define our fermion, we allow the second endpoint of the interface to move inside the domain. Namely, take an edge center z inside Ω_ϵ , and define

$$F_\epsilon(z) := \sum_{\omega(a \rightarrow z)} x^{\text{length of contours}} \mathcal{W}(\omega(a \rightarrow z)) , \quad (7)$$

where the sum is taken over all contour configurations $\omega = \omega(a \rightarrow z)$ which have two exceptional points: a on the boundary and z inside. So the contour collection can be represented (perhaps non-uniquely) as a collection of loops plus an interface between a and z .

Furthermore, the sum is corrected by a *Fermionic* complex weight, depending on the configuration:

$$\mathcal{W}(\omega(a \rightarrow z)) := \exp(-i s \text{winding}(\gamma, a \rightarrow z)) .$$

Here the winding is the total turn of the interface γ connecting a to z , counted in radians, and the *spin* s is equal to $1/2$ (it should not be confused with the Ising spins ± 1). For some collections the interface can be chosen in more than one way, and then we trace it by taking a left turn whenever an ambiguity arises. Another choice might lead to a different value of winding, but if the loops and the interface have no "transversal" self-intersections, then the difference will be a multiple of 4π and so the complex weight \mathcal{W} is well-defined. Equivalently we can write

$$\mathcal{W}(\omega(a \rightarrow z)) = \lambda^{\# \text{ signed turns of } \gamma} , \quad \lambda := \exp\left(-is \frac{\pi}{2}\right) ,$$

see Figure 3 for weights corresponding to different windings.

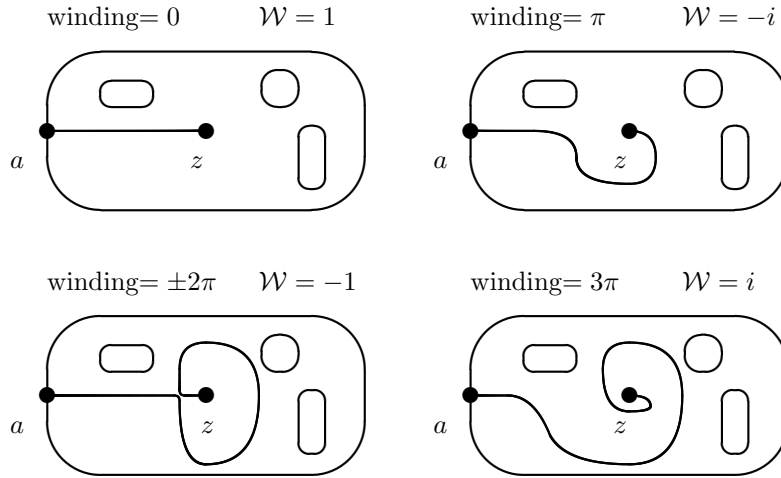

Figure 3. Examples of Fermionic weights one obtains depending on the winding of the interface. Note that in the bottom left example there are two ways to trace the interface from a to z without self-intersections, which give different windings $\pm 2\pi$, but the same complex weight $\mathcal{W} = -1$.

Remark 1. Removing complex weight \mathcal{W} one retrieves the correlation of spins on the dual lattice at the dual temperature x^* , a corollary of the Kramers-Wannier duality.

Remark 2. While such contour collections cannot be directly represented by spin configurations, one can obtain them by creating a *disorder operator*, i.e. a *monodromy* at z : when one goes one time around z , spins change their signs.

Our first theorem is the following, which is proved for general isoradial graphs in [CS09], with a shorter proof for the square lattice given in [CS10]:

Theorem 1 (Chelkak, Smirnov). *For Ising model at criticality, F is a preholomorphic solution of a Riemann boundary value problem. When mesh $\epsilon \rightarrow 0$,*

$$F_\epsilon(z) / \sqrt{\epsilon} \rightrightarrows \sqrt{P'(z)} \text{ inside } \Omega,$$

where P is the complex Poisson kernel at a : a conformal map $\Omega \rightarrow \mathbb{C}_+$ such that $a \mapsto \infty$. Here both sides should be normalized in the same chart around b .

Remark 3. For non-critical values of x observable F becomes *massive preholomorphic*, satisfying the discrete analogue of the massive Cauchy-Riemann equations: $\bar{\partial} F = im(x - x_c)\bar{F}$, cf. [MS09].

Remark 4. Ising model can be represented as a dimer model on the Fisher graph. For example, on the square lattice, one first represents the spin configuration as above — by the collection of contours on the dual lattice, separating

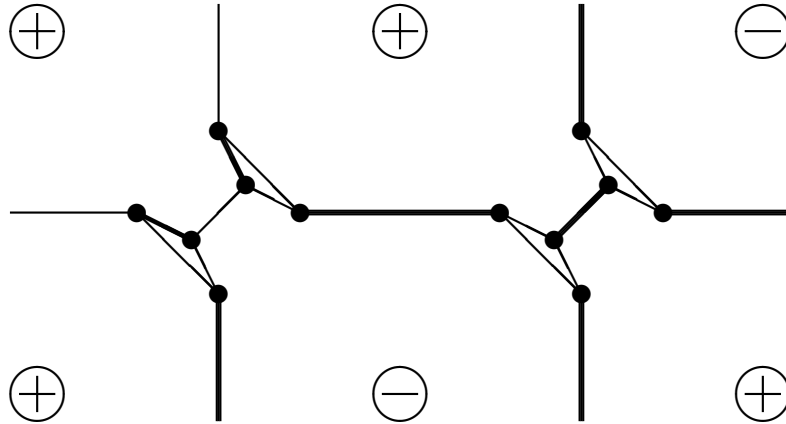

Figure 4. Fisher graph for a region of the square lattice, a spin configuration and a corresponding dimer configuration, with dimers represented by the bold edges.

+ and - spins. Then the dual lattice is modified with every vertex replaced by a “city” of six vertices, see Figure 4. It is easy to see that there is a natural bijection between contour configurations on the dual square lattice and dimer configuration on its Fisher graph.

Then, similarly to the work of Kenyon for the square lattice, the coupling function for the Fisher lattice will satisfy difference equations, which upon examination turn out to be another discretization of Cauchy-Riemann equations, with different projections of the preholomorphic function assigned to six vertices in a “city”. One can then reinterpret the coupling function in terms of the Ising model, and this is the approach taken by Boutillier and de Tilière [BdT08, BdT09].

This is also how the author found the observable discussed in this Section, observing jointly with Kenyon in 2002 that it has the potential to imply the convergence of the interfaces to the Schramm’s SLE curve.

The key to establishing Theorem 1 is the observation that the function F is preholomorphic. Moreover, it turns out that F satisfies a stronger form of preholomorphicity, which implies the usual one, but is better adapted to fermions.

Consider the function F on the centers of edges. We say that F is *strongly* (or *spin*) preholomorphic if for every centers u and v of two neighboring edges emanating from a vertex w , we have

$$\text{Proj}(F(v), 1/\sqrt{\alpha}) = \text{Proj}(F(u), 1/\sqrt{\alpha}) ,$$

where α is the unit bisector of the angle uwv , and $\text{Proj}(p, q)$ denotes the orthogonal projection of the vector p on the vector q . Equivalently we can write

$$F(v) + \bar{\alpha} \overline{F(v)} = F(u) + \bar{\alpha} \overline{F(u)} . \quad (8)$$

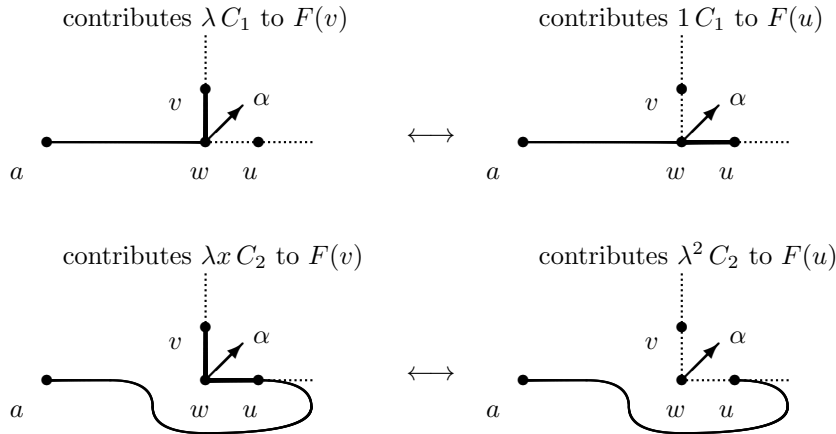

Figure 5. Involution on the Ising model configurations, which adds or erases half-edges vw and uw . There are more pairs, but their relative contributions are always easy to calculate and each pair taken together satisfies the discrete Cauchy-Riemann equations. Note that with the chosen orientation constants C_1 and C_2 above are real.

This definition implies the classical one for the square lattice, and it also easily adapts to the isoradial graphs. Note that for convenience we assume that the interface starts from a in the positive real direction as in Figure 2, which slightly changes weights compared to the convention in [CS09].

The strong preholomorphicity of the Ising model fermion is proved by constructing a bijection between configurations included into $F(v)$ and $F(u)$. Indeed, erasing or adding half-edges wu and wv gives a *bijection* $\omega \leftrightarrow \tilde{\omega}$ between configuration collections $\{\omega(u)\}$ and $\{\omega(v)\}$, as illustrated in Figure 5. To check (8), it is sufficient to check that the sum of contributions from ω and $\tilde{\omega}$ satisfies it. Several possible configurations can be found, but essentially all boil down to the two illustrated in Figure 5.

Plugging the contributions from Figure 5 into the equation (8), we are left to check the following two identities:

$$\lambda + \lambda\bar{\lambda} = 1 + \lambda\bar{1}, \quad \lambda x + \lambda\bar{\lambda}x = \lambda^2 + \lambda\bar{\lambda}^2. \tag{9}$$

The first identity always holds, while the second one is easy to verify when $x = x_c = \sqrt{2} - 1$ and $\lambda = \exp(-\pi i/4)$. Note that in our setup on the square lattice λ (or the spin s) is already fixed by the requirement that the complex weight is well-defined, and so the second equation in (9) uniquely fixes the allowed value of x . In the next Section we will discuss a more general setup, allowing for different values of the spin, corresponding to other lattice models.

To determine F using its preholomorphicity, we need to understand its behavior on the boundary. When $z \in \partial\Omega_\epsilon$, the *winding* of the interface connecting a to z inside Ω_ϵ is uniquely determined, and coincides with the winding of

the boundary itself. This amounts to knowing $\text{Arg}(F)$ on the boundary, which would be sufficient to determine F knowing the singularity at a or the normalization at b .

In the continuous setting the condition obtained is equivalent to the Riemann Boundary Value Problem (a homogeneous version of the Riemann-Hilbert-Privalov BVP)

$$\text{Im} \left(F(z) \cdot (\text{tangent to } \partial\Omega)^{1/2} \right) = 0, \quad (10)$$

with the square root appearing because of the Fermionic weight. Note that the homogeneous BVP above has conformally covariant solutions (as \sqrt{dz} -forms), and so is well defined even in domains with fractal boundaries. The Riemann BVP (10) is clearly solved by the function $\sqrt{P'_a(z)}$, where P is the Schwarz kernel at a (the complex version of the Poisson kernel), i.e. a conformal map

$$P: \Omega \rightarrow \mathbb{C}_+, \quad a \mapsto \infty.$$

Showing that on the lattice F_ϵ satisfies a discretization of the Riemann BVP (10) and converges to its continuous counterpart is highly non-trivial and a priori not guaranteed – there exist “logical” discretizations of the Boundary Value Problems, whose solutions have degenerate or no scaling limits. We establish convergence in [CS09] by considering the primitive $\int_{z_0}^z F^2(u)du$, which satisfies the Dirichlet BVP even in the discrete setting. The big technical problem is that in the discrete case F^2 is no longer preholomorphic, so its primitive is a priori not preholomorphic or even well-defined. Fortunately, in our setting the imaginary part is still well-defined, so we can set

$$H_\epsilon(z) := \frac{1}{2\epsilon} \text{Im} \int^z F(z)^2 dz.$$

While the function H is not exactly preharmonic, it is approximately so, vanishes exactly on the boundary, and is positive inside the domain. This allows to complete the (at times quite involved) proof. A number of non-trivial discrete estimates is called for, and the situation is especially difficult for general isoradial graphs. We provide the needed tools in a separate paper [CS08].

Though Theorem 1 establishes convergence of but one observable, the latter (when normalized at b) is well behaved with respect to the interface traced from a . So it can be used to establish the following, see [CS10]:

Corollary 1. *As mesh of the lattice tends to zero, the critical Ising interface in the discretization of the domain Ω with Dobrushin boundary conditions converges to the Schramm’s SLE(3) curve.*

Convergence is almost immediate in the topology of (probability measures on the space of) Loewner driving functions, but upgrading to convergence of curves requires extra estimates, cf. [KS09, DCHN09, CS10]. Once interfaces

are related to SLE curves, many more properties can be established, including values of dimensions and scaling exponents.

But even without appealing to SLE, one can use preholomorphic functions to a stronger effect. In a joint paper with Hongler [HS10] we study a similar observable, when both ends of the interface are allowed to be inside the domain. It turns out to be preholomorphic in both variables, except for the diagonal, and so its scaling limit can be identified with the Green's function solving the Riemann BVP. On the other hand, when two arguments are taken to be nearby, one retrieves the probability of an edge being present in the contour representation, or that the nearby spins are different. This allows to establish conformal invariance of the energy field in the scaling limit:

Theorem 2 (Hongler, Smirnov). *Let $a \in \Omega$ and $\langle x^\epsilon, y^\epsilon \rangle$ be the closest edge from $a \in \Omega_\epsilon$. Then, as $\epsilon \rightarrow 0$, we have*

$$\begin{aligned}\mathbb{E}_+ [\sigma_x^\epsilon \sigma_y^\epsilon] &= \frac{\sqrt{2}}{2} + \frac{l_\Omega(a)}{\pi} \cdot \epsilon + o(\epsilon), \\ \mathbb{E}_{\text{free}} [\sigma_x^\epsilon \sigma_y^\epsilon] &= \frac{\sqrt{2}}{2} - \frac{l_\Omega(a)}{\pi} \cdot \epsilon + o(\epsilon),\end{aligned}$$

where the subscripts $+$ and free denote the boundary conditions and l_Ω is the element of the hyperbolic metric on Ω .

This confirms the Conformal Field Theory predictions and, as far as we know, for the first time provides the multiplicative constant in front of the hyperbolic metric.

These techniques were taken further by Hongler in [Hon10], where he showed that the (discrete) energy field in the critical Ising model on the square lattice has a conformally covariant scaling limit, which can be then identified with the corresponding Conformal Field Theory. This was accomplished by showing convergence of the discrete energy correlations in domains with a variety of boundary conditions to their continuous counterparts; the resulting limits are conformally covariant and are determined exactly. Similar result was obtained for the scaling limit of the spin field on the domain boundary.

5. The $O(N)$ Model

The Ising preholomorphic function was introduced in [Smi06] in the setting of general $O(N)$ models on the hexagonal lattice. It can be further generalized to a variety of lattice models, see the work of Cardy, Ikhlef, Rajabpour [RC07, IC09]. Unfortunately, the observable seems only partially preholomorphic (satisfying only some of the Cauchy-Riemann equations) except for the Ising case. One can make an analogy with divergence-free vector fields, which are not a priori curl-free.

The argument in the previous Section was adapted to the Ising case, and some properties remain hidden behind the notion of the strong holomorphicity. Below we present its version generalized to the $O(N)$ model, following our joint work [DCS10] with Duminil-Copin. While for $N \neq 1$ we only prove that our observable is divergence-free, it still turns out to be enough to deduce some global information, establishing the Nienhuis conjecture on the exact value of the connective constant for the hexagonal lattice:

Theorem 3 (Duminil-Copin, Smirnov). *On the hexagonal lattice the number $C(k)$ of distinct simple length k curves from the origin satisfies*

$$\lim_{k \rightarrow \infty} \frac{1}{k} \log C(k) = \log \sqrt{2 + \sqrt{2}} . \quad (11)$$

Self-avoiding walks on a lattice (those without self-intersections) were proposed by chemist Flory [Flo53] as a model for polymer chains, and turned out to be an interesting and extensively studied object, see the monograph [MS93].

Using Coulomb gas formalism, physicist Nienhuis argued that the connective constant of the hexagonal lattice is equal to $\sqrt{2 + \sqrt{2}}$, meaning that (11) holds. He even proposed better description of the asymptotic behavior:

$$C(k) \approx \left(\sqrt{2 + \sqrt{2}} \right)^k k^{11/32}, \quad k \rightarrow \infty . \quad (12)$$

Note that while the exponential term with the connectivity constant is lattice-dependent, the power law correction is supposed to be universal.

Our proof is partially motivated by Nienhuis' arguments, and also starts with considering the self-avoiding walk as a special case of $O(N)$ model at $N = 0$. While a "half-preholomorphic" observable we construct does not seem sufficient to imply conformal invariance in the scaling limit, it can be used to establish the critical temperature, which gives the connective constant.

The general $O(N)$ model is defined for positive integer values of N , and is a generalization of the Ising model (to which it specializes for $N = 1$), with ± 1 spins replaced by points on a sphere in the N -dimensional space. We work with the graphical representation, which is obtained using the *high-temperature expansion*, and makes the model well defined for all non-negative values of N .

We concentrate on the hexagonal lattice in part because it is trivalent and so at most one contour can pass through a vertex, creating no ambiguities. This simplifies the reasoning, though general graphs can also be addressed by introducing additional weights for multiple visits of vertices. We consider configurations ω of disjoint simple loops on the mesh ϵ hexagonal lattice inside domain Ω_ϵ , and two parameters: loop-weight $N \geq 0$ and (temperature-like) edge-weight $x > 0$. Partition function is then given by

$$Z = \sum_{\omega} N^{\#\text{ loops}} x^{\text{length of contours}} .$$

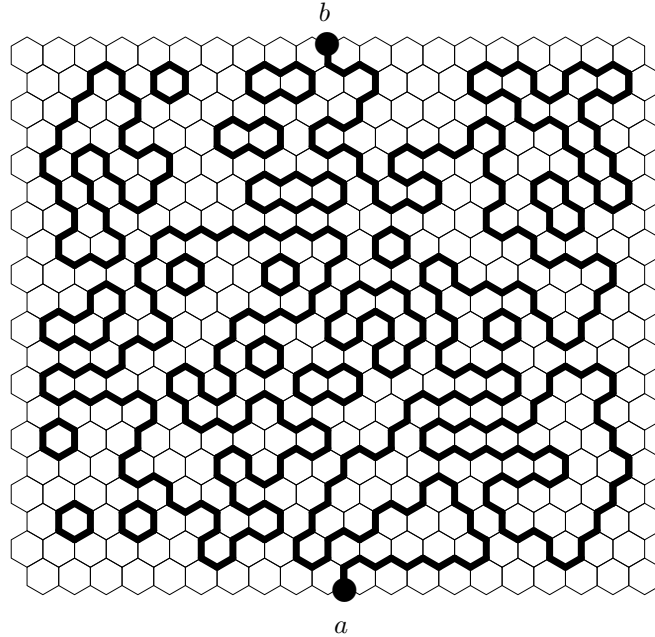

Figure 6. The high-temperature expansion of the $O(N)$ model leads to a gas of disjoint simple loops. Probability of a configuration is proportional to $N^{\# \text{ loops}} x^{\text{length}}$. We study it with Dobrushin boundary conditions: besides loops, there is an interface between two boundary points a and b .

A typical configuration is pictured in Figure 6, where we introduced Dobrushin boundary conditions: besides loops, there is an interface γ joining two fixed boundary points a and b . It was conjectured by Kager and Nienhuis [KN04] that in the interval $N \in [0, 2]$ the model has conformally invariant scaling limits for $x = x_c(N) := 1/\sqrt{2 + \sqrt{2 - N}}$ and $x \in (x_c(N), +\infty)$. The two different limits correspond to dilute/dense regimes, with the interface γ conjecturally converging to the Schramm's SLE curves for an appropriate value of $\kappa \in [8/3, 4]$ and $\kappa \in [4, 8]$ correspondingly. The scaling limit for low temperatures $x \in (0, x_c)$ is not conformally invariant.

Note that for $N = 1$ we do not count the loops, thus obtaining the low-temperature expansion of the Ising model on the dual triangular lattice. In particular, the critical Ising corresponds to $x = 1/\sqrt{3}$ by the work [Wan50] of Wannier, in agreement with Nienhuis predictions. And for $x = 1$ one obtains the critical site percolation on triangular lattice (or equivalently the Ising model at infinite temperature). The latter is conformally invariant in the scaling limit by [Smi01b, Smi01a].

Note also that the Dobrushin boundary conditions make the model well-defined for $N = 0$: then we have only one interface, and no loops. In the dilute

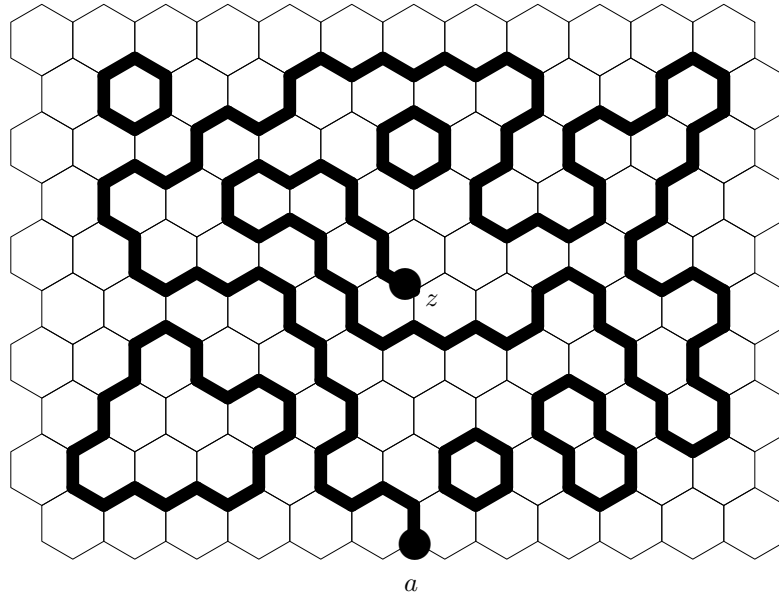

Figure 7. To obtain the parafermionic observable in the $O(N)$ model we consider configurations with an interface joining a boundary point a to an interior point z and weight them by a complex weight depending on the winding of the interface.

regime this model is expected to be in the universality class of the self-avoiding walk.

Analogously to the Ising case, we define an observable (which is now a *parafermion* of fractional spin) by moving one of the ends of the interface inside the domain. Namely, for an edge center z we set

$$F_\epsilon(z) := \sum_{\omega(a \rightarrow z)} x^{\text{length of contours}} \mathcal{W}(\omega(a \rightarrow z)) , \quad (13)$$

where the sum is taken over all configurations $\omega = \omega(a \rightarrow z)$ which have disjoint simple contours: a number of loops and an interface γ joining two exceptional points, a on the boundary and z inside. As before, the sum is corrected by a complex weight with the *spin* $s \in \mathbb{R}$:

$$\mathcal{W}(\omega(a \rightarrow z)) := \exp(-i s \text{winding}(\gamma, a \rightarrow z)) ,$$

equivalently we can write

$$\mathcal{W}(\omega(a \rightarrow z)) = \lambda^{\# \text{ signed turns of } \gamma} , \quad \lambda := \exp\left(-i s \frac{\pi}{3}\right) .$$

Note that on hexagonal lattice one turn corresponds to $\pi/3$, hence the difference in the definition of λ .

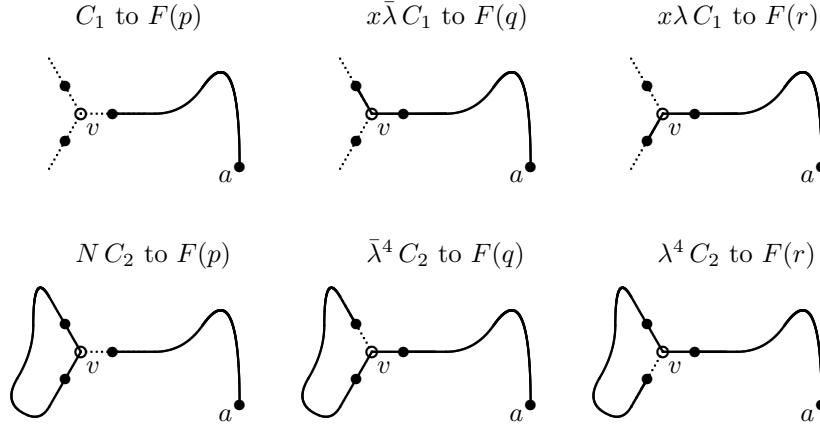

Figure 8. Configurations with the interface ending at one of the three neighbors of v are grouped into triplets by adding or removing half-edges around v . Two essential examples of triplets are pictured above, along with their relative contributions to the identity (13).

Our key observation is the following

Lemma 4. For $N \in [0, 2]$, set $2 \cos(\theta) = N$ with parameter $\theta \in [0, \pi/2]$. Then for

$$s = \frac{\pi - 3\theta}{4\pi}, \quad x^{-1} = 2 \cos\left(\frac{\pi + \theta}{4}\right) = \sqrt{2 - \sqrt{2 - N}}, \quad \text{or} \quad (14)$$

$$s = \frac{\pi + 3\theta}{4\pi}, \quad x^{-1} = 2 \cos\left(\frac{\pi - \theta}{4}\right) = \sqrt{2 + \sqrt{2 - N}}, \quad (15)$$

the observable F satisfies the following relation for every vertex v inside Ω_ϵ :

$$(p - v)F(p) + (q - v)F(q) + (r - v)F(r) = 0, \quad (16)$$

where p, q, r are the mid-edges of the three edges adjacent to v .

Above solution (14) corresponds to the dense, and (15) – to the dilute regime. Note that identity (16) is a form of the first Kirchhoff’s law, but apart from the Ising case $N = 1$ we cannot verify the second one.

To prove Lemma 4, we note that configurations with an interface arriving at p, q or r can be grouped in triplets, so that three configurations differ only in immediate vicinity of v , see Figure 8. It is enough then to check that contributions of three configurations to (16) sum up to zero. But the relative weights of configurations in a triplet are easy to write down as shown in Figure 8, and the coefficients in the identity (16) are proportional to the three cube roots of unity: $1, \tau := \exp(i2\pi/3), \bar{\tau}$ (if the neighbors of v are taken in the counterclockwise

order). Therefore we have to check just two identities:

$$\begin{aligned} N + \tau \bar{\lambda}^4 + \bar{\tau} \lambda^4 &= 0, \\ 1 + \tau x \bar{\lambda} + \bar{\tau} x \lambda &= 0. \end{aligned}$$

Recalling that $\lambda = \exp(-is\pi/3)$, the equations above can be recast as

$$\begin{aligned} -\frac{2\pi}{3} - 4s\frac{\pi}{3} &= \pm(\pi - \theta) + 2\pi k, \quad k \in \mathbb{Z}, \\ x &= -1 \left/ \left(2 \cos \left(\frac{(2+s)\pi}{3} \right) \right) \right. . \end{aligned}$$

The first equation implies that

$$s = \pm \left(-\frac{3}{4} + \frac{3\theta}{4\pi} \right) - \frac{1}{2} - \frac{3}{2}k, \quad k \in \mathbb{Z}, \quad (17)$$

and the second equation then determines the allowed value of x uniquely. Most of the solutions of (17) lead to observables symmetric to the two main ones, which are provided by solutions to the equations (14) and (15).

When we set $N = 0$, there are no loops, and configurations contain just an interface from a to z , weighted by x^{length} . This corresponds to taking $\theta = \pi/2$ and one of the solutions is given by $s = 5/8$ and $x_c = 1/\sqrt{2 + \sqrt{2}}$, as predicted by Nienhuis. To prove his prediction, we observe that summing the identity (16) over all interior vertices implies that

$$\sum_{z \in \partial\Omega_\epsilon} F(z)\eta(z) = 0,$$

where the sum taken over the centers z of oriented edges $\eta(z)$ emanating from the discrete domain Ω_ϵ into its exterior. Since $F(a) = 1$ by definition, we conclude that F for other boundary points sums up to 1. As in the Ising model, the winding on the boundary is uniquely determined, and (for this particular critical value of x), one observes that considering the real part of F we can get rid of the complex weights, replacing them by explicit positive constants (depending on the slope of the boundary). Thus we obtain an equation

$$\sum_{z \in \partial\Omega_\epsilon \setminus \{a\}} \sum_{\omega(a \rightarrow z)} x_c^{\text{length of contours}} \asymp 1,$$

regardless of the size of the domain Ω_ϵ . A simple counting argument then shows that the series

$$\sum_k C(k) x^k = \sum_{\text{simple walks from } a \text{ inside } \mathbb{C}} x^{\text{length}},$$

converges when $x < x_c$ and diverges when $x > x_c$, clearly implying the conjecture.

Note that establishing the holomorphicity of our observable in the scaling limit would allow to relate self-avoiding walk to the Schramm's SLE with $\kappa = 8/3$ and together with the work [LSW04] of Lawler, Schramm and Werner to establish the more precise form (12) of the Nienhuis prediction.

6. What's Next

Below we present a list of open questions. As before, we do not aim for completeness, rather we highlight a few directions we find particularly intriguing.

Question 1. As was discussed, discrete complex analysis is well developed for isoradial graphs (or rhombic lattices), see [Duf68, Mer01, Ken02, CS08]. Is there a more general discrete setup where one can get similar estimates, in particular convergence of preholomorphic functions to the holomorphic ones in the scaling limit? Since not every topological quadrangulation admits a rhombic embedding [KS05], can we always find another embedding with a sufficiently nice version of discrete complex analysis? Same question can be posed for triangulations, with variations of the first definition by Isaacs (5), like the ones in the work of Dynnikov and Novikov [DN03] being promising candidates.

Question 2. Variants of the Ising observable were used by Hongler and Kytölä to connect interfaces in domains with more general boundary conditions to more advanced variants of SLE curves, see [HK09]. Can one use some version of this observable to describe the spin Ising loop soup by a collection of branching interfaces, which converge to a branching SLE tree in the scaling limit? Similar argument is possible for the random cluster representation of the Ising model, see [KS10]. Can one construct the energy field more explicitly than in [Hon10], e.g. in the distributional sense? Can one construct other Ising fields?

Question 3. So far “half-preholomorphic” parafermions similar to ones discussed in this paper have been found in a number of models, see [Smi06, RC06, RC07, IC09], but they seem fully preholomorphic only in the Ising case. Can we find the other half of the Cauchy-Riemann equations, perhaps for some modified definition? Note that it seems unlikely that one can establish conformal invariance of the scaling limit operating with only half of the Cauchy-Riemann equations, since there is no conformal structure present.

Question 4. In the case of the self-avoiding walk, an observable satisfying only a half of the Cauchy-Riemann equations turned out to be enough to derive the value of the connectivity constant [DCS10]. Since similar observables are available for all other $O(N)$ models, can we use them to establish the critical temperature values predicted by Nienhuis? Our proof cannot be directly transferred, since some counting estimates use the absence of loops. Similar question can be asked for other models.

Question 5. If we cannot establish the preholomorphicity of our observables exactly, can we try to establish it approximately? With appropriate estimates that would allow to obtain holomorphic functions in the scaling limit and hence prove conformal invariance of the models concerned. Note that such more general approach worked for the critical site percolation on the triangular lattice [Smi01b, Smi01a], though approximate preholomorphicity was a consequence of exact identities for quantities similar to discrete derivatives.

Question 6. Can we find other preholomorphic observables besides ones mentioned here and in [Smi06]? It is also peculiar that all the models where preholomorphic observables were found so far (the dimer model, the uniform spanning tree, the Ising model, percolation, etc.) can be represented as dimer models. Are there any models in other universality classes, admitting a dimer representation? Can then Kenyon's techniques [Ken04, Ken09] be used to find preholomorphic observables by considering the Kasteleyn's matrix and the coupling function?

Question 7. Throughout this paper we were concerned with linear discretizations of the Cauchy-Riemann equations. Those seem more natural in the probabilistic context, in particular they might be easier to relate to the SLE martingales, cf. [Smi06]. However there are also well-known non-linear versions of the Cauchy-Riemann equations. For example, the following version of the Hirota equation for a complex-valued function F arises in the context of the circle packings, see e.g. [BMS05]:

$$\frac{(F(z+i\epsilon) - F(z-\epsilon))(F(z-i\epsilon) - F(z+\epsilon))}{(F(z+i\epsilon) - F(z+\epsilon))(F(z-i\epsilon) - F(z-\epsilon))} = -1. \quad (18)$$

Can we observe this or a similar equation in the probabilistic context and use it to establish conformal invariance of some model? Note that plugging into the equation (18) a smooth function, we conclude that to satisfy it approximately it must obey the identity

$$(\partial_x F(z))^2 + (\partial_y F(z))^2 = 0.$$

So in the scaling limit (18) can be factored into the Cauchy-Riemann equations and their complex conjugate, thus being in some sense linear. It does not seem possible to obtain "essential" non-linearity using just four points, but using five points one can create one, as in the next question.

Question 8. A number of non-linear identities was discovered for the correlation functions in the Ising model, starting with the work of Groeneveld, Boel and Kasteleyn [GBK78, BK78]. We do not want to analyze the extensive literature to-date, but rather pose a question: can any of these relations be used to define discrete complex structures and pass to the scaling limit? In two of the early papers by McCoy, Wu and Perk [MW80, Per80], a quadratic difference relation was observed in the full plane Ising model first on the square lattice,

and then on a general graph. To better adapt to our setup, we rephrase this relation for the correlation $C(z)$ of two spins (one at the origin and another at z) in the Ising model at criticality on the mesh ϵ square lattice. In the full plane, one has

$$C(z + i\epsilon)C(z - i\epsilon) + C(z + \epsilon)C(z - \epsilon) = 2C(z)^2 . \quad (19)$$

Note that C is a *real-valued* function, and the equation (19) is a discrete form of the identity

$$C(z)\Delta C(z) + |\nabla C(z)|^2 = 0 .$$

The latter is conformally invariant, and is solved by moduli of analytic functions. Can one write an analogous to (19) identity in domains with boundary, perhaps approximately? Can one deduce conformally invariant scaling limit of the spin correlations in that way?

Question 9. Recently there was a surge of interest in random planar graphs and their scaling limits, see e.g. [DS09, LGP08]. Can one find observables on random planar graphs (weighted by the partition function of some lattice model) which after an appropriate embedding (e.g. via a circle packing or a piecewise-linear Riemann surface) are preholomorphic? This would help to show that planar maps converge to the Liouville Quantum Gravity in the scaling limit.

Question 10. Approach to the two-dimensional integrable models described here is in several aspects similar to the older approaches based on the Yang-Baxter relations [Bax89]. Some similarities are discussed in Cardy's paper [Car09]. Can one find a direct link between the two approaches? It would also be interesting to find a link to the three-dimensional consistency relations as discussed in [BMS09].

Question 11. Recently Kenyon investigated the Laplacian on the vector bundles over graphs in relation to the spanning trees [Ken10]. Similar setup seems natural for the Ising observable we discuss. Can one obtain more information about the Ising and other models by studying difference operators on vector bundles over the corresponding graphs?

Question 12. Can anything similar be done for the three-dimensional models? While preholomorphic functions do not exist here, preharmonic vector fields are well-defined and appear naturally for the Uniform Spanning Tree and the Loop Erased Random Walk. To what extent can they be used? Can one find any other difference equations in three-dimensional lattice models?

References

- [Bax78] R. J. Baxter. Solvable eight-vertex model on an arbitrary planar lattice. *Philos. Trans. Roy. Soc. London Ser. A*, 289(1359):315–346, 1978.

- [Bax89] Rodney J. Baxter. *Exactly solved models in statistical mechanics*. Academic Press Inc. [Harcourt Brace Jovanovich Publishers], London, 1989. Reprint of the 1982 original.
- [BdT08] Cédric Boutillier and Béatrice de Tilière. The critical Z-invariant Ising model via dimers: the periodic case. *Probab. Theory Related Fields*, 147: 379–413, 2010.
- [BdT09] Cédric Boutillier and Béatrice de Tilière. The critical Z-invariant Ising model via dimers: locality property. *Comm. Math. Physics*, to appear. Preprint arXiv:0902.1282, 2009.
- [BK78] R. J. Boel and P. W. Kasteleyn. Correlation-function identities and inequalities for Ising models with pair interactions. *Comm. Math. Phys.*, 61(3):191–208, 1978.
- [BMS05] Alexander I. Bobenko, Christian Mercat, and Yuri B. Suris. Linear and nonlinear theories of discrete analytic functions. Integrable structure and isomonodromic Green’s function. *J. Reine Angew. Math.*, 583:117–161, 2005.
- [BMS09] Vladimir V. Bazhanov, Vladimir V. Mangazeev, and Sergey M. Sergeev. Quantum geometry of 3-dimensional lattices and tetrahedron equation. Preprint, arXiv:0911.3693, 2009.
- [Bou26] George Bouligand. Sur le problème de Dirichlet. *Ann. Soc. Pol. Math.*, 4:59–112, 1926.
- [BS08] Alexander I. Bobenko and Yuri B. Suris. *Discrete differential geometry*, volume 98 of *Graduate Studies in Mathematics*. American Mathematical Society, Providence, RI, 2008.
- [BSST40] R. L. Brooks, C. A. B. Smith, A. H. Stone, and W. T. Tutte. The dissection of rectangles into squares. *Duke Math. J.*, 7:312–340, 1940.
- [Car09] John Cardy. Discrete holomorphicity at two-dimensional critical points. *J. Stat. Phys.*, 137(5-6):814–824, 2009.
- [CFL28] R. Courant, K. Friedrichs, and H. Lewy. Über die partiellen Differenzengleichungen der mathematischen Physik. *Math. Ann.*, 100:32–74, 1928.
- [CS08] Dmitry Chelkak and Stanislav Smirnov. Discrete complex analysis on isoradial graphs. *Adv. in Math.*, to appear. Preprint, arXiv:0810.2188, 2008.
- [CS09] Dmitry Chelkak and Stanislav Smirnov. Universality in the 2D Ising model and conformal invariance of fermionic observables. *Invent. Math.*, to appear. Preprint, arXiv:0910.2045, 2009.
- [CS10] Dmitry Chelkak and Stanislav Smirnov. Conformal invariance of the 2D Ising model at criticality. Preprint, 2010.
- [DCHN09] Hugo Duminil-Copin, Clément Hongler, and Pierre Nolin. Connection probabilities and RSW-type bounds for the FK Ising model. Preprint, arXiv:0912.4253, 2009.
- [DCS10] Hugo Duminil-Copin and Stanislav Smirnov. The connective constant of the honeycomb lattice equals $\sqrt{2 + \sqrt{2}}$. Preprint, arXiv:1007.0575, 2010.

- [DM71] Charles R. Deeter and C. Wayne Mastin. The discrete analog of a minimum problem in conformal mapping. *Indiana Univ. Math. J.*, 20:355–367, 1970/1971.
- [DN03] I. A. Dynnikov and S. P. Novikov. Geometry of the triangle equation on two-manifolds. *Moscow Math. J.*, 3:419–438, 2003.
- [DS09] Bertrand Duplantier and Scott Sheffield. Duality and the Knizhnik-Polyakov-Zamolodchikov relation in Liouville quantum gravity. *Phys. Rev. Lett.*, 102(15):150603, 4, 2009.
- [Duf56] R. J. Duffin. Basic properties of discrete analytic functions. *Duke Math. J.*, 23:335–363, 1956.
- [Duf68] R. J. Duffin. Potential theory on a rhombic lattice. *J. Combinatorial Theory*, 5:258–272, 1968.
- [Fer44] Jacqueline Ferrand. Fonctions préharmoniques et fonctions préholomorphes. *Bull. Sci. Math. (2)*, 68:152–180, 1944.
- [Flo53] P. Flory. *Principles of Polymer Chemistry*. Cornell University Press, 1953.
- [GBK78] J. Groeneveld, R. J. Boel, and P. W. Kasteleyn. Correlation-function identities for general planar Ising systems. *Physica A: Statistical and Theoretical Physics*, 93(1-2):138–154, 1978.
- [HK09] Clément Hongler and Kalle Kytölä. Dipolar SLE in Ising model with plus-minus-free boundary conditions. Preprint, 2009.
- [Hon10] Clément Hongler. Conformal invariance of the Ising model correlations. Ph.D. thesis, Université de Genève, 2010.
- [HS93] Zheng-Xu He and Oded Schramm. Fixed points, Koebe uniformization and circle packings. *Ann. of Math. (2)*, 137(2):369–406, 1993.
- [HS10] Clément Hongler and Stanislav Smirnov. Energy density in the 2D Ising model. Preprint, arXiv:1008.2645, 2010.
- [IC09] Yacine Ikhlef and John Cardy. Discretely holomorphic parafermions and integrable loop models. *J. Phys. A*, 42(10):102001, 11, 2009.
- [Isa41] Rufus Philip Isaacs. A finite difference function theory. *Univ. Nac. Tucumán. Revista A.*, 2:177–201, 1941.
- [Isa52] Rufus Isaacs. Monodiffric functions. Construction and applications of conformal maps. In *Proceedings of a symposium*, National Bureau of Standards, Appl. Math. Ser., No. 18, pages 257–266, Washington, D. C., 1952. U. S. Government Printing Office.
- [KC71] Leo P. Kadanoff and Horacio Ceva. Determination of an operator algebra for the two-dimensional Ising model. *Phys. Rev. B (3)*, 3:3918–3939, 1971.
- [Ken00] Richard Kenyon. Conformal invariance of domino tiling. *Ann. Probab.*, 28(2):759–795, 2000.
- [Ken01] Richard Kenyon. Dominos and the Gaussian free field. *Ann. Probab.*, 29(3):1128–1137, 2001.
- [Ken02] Richard Kenyon. The Laplacian and Dirac operators on critical planar graphs. *Invent. Math.*, 150(2):409–439, 2002.

- [Ken04] Richard Kenyon. An introduction to the dimer model. In *School and Conference on Probability Theory*, ICTP Lect. Notes, XVII, pages 267–304 (electronic). Abdus Salam Int. Cent. Theoret. Phys., Trieste, 2004.
- [Ken09] Richard Kenyon. Lectures on dimers. In *Statistical mechanics*, volume 16 of *IAS/Park City Math. Ser.*, pages 191–230. Amer. Math. Soc., Providence, RI, 2009.
- [Ken10] Richard Kenyon. Spanning forests and the vector bundle Laplacian. Preprint arXiv:1001.4028, 2010.
- [Kir47] G. Kirchhoff. Ueber die Auflösung der Gleichungen, auf welche man bei der Untersuchung der linearen Vertheilung galvanischer Ströme geführt wird. *Annalen der Physik und Chemie*, 148(12):497–508, 1847.
- [Kis05] Christer O. Kiselman. Functions on discrete sets holomorphic in the sense of Isaacs, or monodiffic functions of the first kind. *Sci. China Ser. A*, 48(suppl.):86–96, 2005.
- [KN04] Wouter Kager and Bernard Nienhuis. A guide to stochastic Löwner evolution and its applications. *J. Statist. Phys.*, 115(5-6):1149–1229, 2004.
- [KS05] Richard Kenyon and Jean-Marc Schlenker. Rhombic embeddings of planar quad-graphs. *Trans. Amer. Math. Soc.*, 357(9):3443–3458 (electronic), 2005.
- [KS09] Antti Kemppainen and Stanislav Smirnov. Random curves, scaling limits and Loewner evolutions. Preprint, University of Helsinki, 2009.
- [KS10] Antti Kemppainen and Stanislav Smirnov. Conformal invariance in random cluster models. III. Full scaling limit. In preparation, 2010.
- [KW41] H.A. Kramers and G.H. Wannier. Statistics of the two-dimensional ferromagnet. Pt. 1. *Phys. Rev., II. Ser.*, 60:252–262, 1941.
- [LF55] Jacqueline Lelong-Ferrand. *Représentation conforme et transformations à intégrale de Dirichlet bornée*. Gauthier-Villars, Paris, 1955.
- [LGP08] Jean-François Le Gall and Frédéric Paulin. Scaling limits of bipartite planar maps are homeomorphic to the 2-sphere. *Geom. Funct. Anal.*, 18(3):893–918, 2008.
- [Lov04] László Lovász. Discrete analytic functions: an exposition. In *Surveys in differential geometry. Vol. IX*, Surv. Differ. Geom., IX, pages 241–273. Int. Press, Somerville, MA, 2004.
- [LSW04] Gregory F. Lawler, Oded Schramm, and Wendelin Werner. On the scaling limit of planar self-avoiding walk. In *Fractal geometry and applications: a jubilee of Benoît Mandelbrot, Part 2*, volume 72 of *Proc. Sympos. Pure Math.*, pages 339–364. Amer. Math. Soc., Providence, RI, 2004.
- [Lus26] L. Lusternik. Über einige Anwendungen der direkten Methoden in Variationsrechnung. *Recueil de la Société Mathématique de Moscou*, pages 173–201, 1926.
- [Mer01] Christian Mercat. Discrete Riemann surfaces and the Ising model. *Comm. Math. Phys.*, 218(1):177–216, 2001.

- [Mer07] Christian Mercat. Discrete Riemann surfaces. In *Handbook of Teichmüller theory. Vol. I*, volume 11 of *IRMA Lect. Math. Theor. Phys.*, pages 541–575. Eur. Math. Soc., Zürich, 2007.
- [MS93] Neal Madras and Gordon Slade. *The self-avoiding walk*. Probability and its Applications. Birkhäuser Boston Inc., Boston, MA, 1993.
- [MS09] Nikolai Makarov and Stanislav Smirnov. Off-critical lattice models and massive SLEs. In *XIVth International Congress on Mathematical Physics, Lisbon, Portugal, July 28 – August 2, 2003*, pages 362–371. World Sci. Publ., Singapore, 2009.
- [MW80] Barry M. McCoy and Tai Tsun Wu. Non-linear partial difference equations for the two-dimensional Ising model. *Physics Review Letters*, 45:675–678, 1980.
- [Per80] J. H. H. Perk. Quadratic identities for Ising model correlations. *Physics Letters*, 79A:3–5, 1980.
- [PW23] H. B. Phillips and N. Wiener. Nets and the Dirichlet problem. *Mass. J. of Math.*, 2:105–124, 1923.
- [RC06] V. Riva and J. Cardy. Holomorphic parafermions in the Potts model and stochastic Loewner evolution. *J. Stat. Mech. Theory Exp.*, (12):P12001, 19 pp. (electronic), 2006.
- [RC07] M. A. Rajabpour and J. Cardy. Discretely holomorphic parafermions in lattice Z_N models. *J. Phys. A*, 40(49):14703–14713, 2007.
- [RS87] Burt Rodin and Dennis Sullivan. The convergence of circle packings to the Riemann mapping. *J. Differential Geom.*, 26(2):349–360, 1987.
- [Smi01a] Stanislav Smirnov. Critical percolation in the plane. Preprint, arXiv:0909.4499, 2001.
- [Smi01b] Stanislav Smirnov. Critical percolation in the plane: Conformal invariance, Cardy’s formula, scaling limits. *C. R. Math. Acad. Sci. Paris*, 333(3):239–244, 2001.
- [Smi06] Stanislav Smirnov. Towards conformal invariance of 2D lattice models. Sanz-Solé, Marta (ed.) et al., Proceedings of the international congress of mathematicians (ICM), Madrid, Spain, August 22–30, 2006. Volume II: Invited lectures, 1421–1451. Zürich: European Mathematical Society (EMS), 2006.
- [Smi10] Stanislav Smirnov. Conformal invariance in random cluster models. I. Holomorphic spin structures in the Ising model. *Ann. of Math. (2)*, 172:101–133, 2010.
- [Ste05] Kenneth Stephenson. *Introduction to circle packing. The theory of discrete analytic functions*. Cambridge University Press, Cambridge, 2005.
- [Thu86] William P. Thurston. Zippers and univalent functions. In *The Bieberbach conjecture (West Lafayette, Ind., 1985)*, volume 21 of *Math. Surveys Monogr.*, pages 185–197. Amer. Math. Soc., Providence, RI, 1986.
- [Wan50] G. H. Wannier. Antiferromagnetism. The triangular Ising net. *Phys. Rev.*, 79(2):357–364, Jul 1950.

Large Deviations

S.R.S. Varadhan*

Abstract

The theory of Large Deviations deals with techniques for estimating probabilities of rare events. These probabilities are exponentially small in a natural parameter and the task is to determine the exponential constant. To be precise, we will have a family P_n of probability distributions on a space \mathcal{X} and asymptotically

$$P_n(A) = \exp \left[-n \inf_{x \in A} I(x) + o(n) \right]$$

for a large class of sets, with a suitable choice of the function $I(x)$. This function is almost always related to some form of entropy. There are connections to statistical mechanics as well as applications to the study of scaling limits for large systems. The subject had its origins in the Scandinavian insurance industry where it was used for the evaluation of risk. Since then, it has undergone many developments and we will review some of the recent progress.

Mathematics Subject Classification (2010). Primary 60F10; Secondary 60-02.

Keywords. Large deviations

1. What Are Large Deviations?

What are Large Deviations and why are they called by that name? The law of large numbers plays a central role in probability and statistics. While we cannot predict the outcome of a single toss of a coin, one expects that repeated tosses will produce roughly an equal number of heads and tails. Of course we are not naive to believe that the numbers will be exactly equal. There will be deviations or fluctuations. The central limit theorem asserts that if the coin is tossed N times the deviation from the “expected” number $\frac{N}{2}$ of heads will be of the order \sqrt{N} and the deviation normalized by $\sqrt{\frac{N}{4}}$ will produce a “random”

*This research was partially supported by NSF grant DMS-0904701.

Courant Institute, New York University, 251, Mercer Street, New York, NY, 10012, USA.
E-mail: varadhan@cims.nyu.edu

quantity whose distribution is the standard Gaussian distribution. This is really a mathematical result

$$\lim_{N \rightarrow \infty} \sum_{r \geq \frac{N}{2} + x \left(\frac{N}{4}\right)^{\frac{1}{2}}} \frac{1}{2^N} \binom{N}{r} = \frac{1}{\sqrt{2\pi}} \int_x^\infty \exp\left[-\frac{y^2}{2}\right] dy$$

Deviations of order \sqrt{N} are called fluctuations or “normal” deviations. Deviations that are larger than \sqrt{N} while they are theoretically possible, are not very probable. For instance if $\alpha > \frac{1}{2}$,

$$\lim_{N \rightarrow \infty} \sum_{r \geq \frac{N}{2} + x N^\alpha} \frac{1}{2^N} \binom{N}{r} = 0$$

One can ask how fast? If we think of xN^α as $2xN^{a-\frac{1}{2}}\left(\frac{N}{4}\right)^{\frac{1}{2}}$ perhaps one can then guess that

$$\sum_{r \geq \frac{N}{2} + x N^a} \frac{1}{2^N} \binom{N}{r} \simeq \sqrt{2\pi} \int_{2xN^{a-\frac{1}{2}}}^\infty \exp\left[-\frac{y^2}{2}\right] dy = \exp[-2x^2N^{2a-1} + o(N^{2a-1})]$$

This is actually correct if $a < 1$. These are called “moderate deviations”. The behavior is like the far tail of a Gaussian distribution. The answers change as soon as $a = 1$. For $x > \frac{1}{2}$,

$$(1) \quad \sum_{r \geq xN} \frac{1}{2^N} \binom{N}{r} = \exp[-I(x)N + o(N)]$$

where $I(x) = x \log[2x] + (1-x) \log[2(1-x)]$. Now we are talking about “Large Deviations”. It is not so much because the deviations have suddenly become large, but rather the answers have suddenly become different making the problems considerably more interesting!

2. Formulation

The estimate (1) is not hard to derive. If $r = Nx$, then one can use Stirling’s formula to calculate $\binom{N}{r}$ and we get

$$\log \binom{N}{r} = -N[x \log x + (1-x) \log(1-x)] + o(N) = Nh(x) + o(N)$$

Entropy comes up because we can have r heads in many different ways and the number of such ways is $\binom{N}{r} = \exp[Nh(x) + o(N)]$ and each one carries a probability of 2^{-N} . This leads to

$$p_N(r) = \exp[-N(\log 2 - h(x)) + o(N)]$$

The summation over r involves at most N terms and can only make an insignificant correction to the exponential rate. This provides the formula

$$-\frac{1}{N} \log \sum_{r \geq Nx} p_N(r) \simeq \inf_{y \geq x} [\log 2 - h(y)] = \log 2 - h(x)$$

if $x \geq \frac{1}{2}$. The probabilities $p_N(r) = \exp[-N I(y) + o(N)]$ decay exponentially if $r \simeq Ny$ with $y \neq \frac{1}{2}$ and the sum over $r \geq Nx$ behaves essentially like the supremum.

This makes the calculations in large deviation problems more accessible. Summation or integration due to aggregation is replaced by optimization leading to variational formulas for asymptotic evaluation of probabilities and integrals. There are two terms that contribute, one measuring the decay rate of the probabilities of individual microscopic events and one measuring the multiplicity of microscopic events that make up the event in question.

The earliest systematic treatment of large deviation estimates goes back to nineteen thirties, to the work carried out by Cramér [3]. If $\{X_i\}$ are independent identically distributed random variables with $E[X] = m$ then for $a > m$,

$$P \left[\frac{1}{N} \sum_{i=1}^N X_i \geq a \right] = \exp[-NI(a) + o(N)]$$

where $I(a) = \sup_{\theta} [\theta a - \log E[e^{\theta X}]]$. While deviations of the form $Y \geq a$ are natural in the case of the real line R , in higher dimensions or a more abstract setting one needs a reformulation.

One starts with a reasonable abstract space \mathcal{X} with its Borel σ -field (a complete separable metric space is OK.) and one has a family P_N of probability distributions on $(\mathcal{X}, \mathcal{B})$. They may concentrate at some point as $N \rightarrow \infty$. One says that P_N satisfies a large deviations principle with a rate function $I(x)$ if the following are true.

1. $I : X \rightarrow [0, \infty]$ is lower semi-continuous.
2. $K_\ell = \{x : I(x) \leq \ell\}$ is a compact subset of \mathcal{X} for each $\ell < \infty$
3. For every open set $G \in \mathcal{X}$

$$\liminf_{N \rightarrow \infty} \frac{1}{N} \log P_N(G) \geq - \inf_{x \in G} I(x)$$

4. For every closed set $C \in \mathcal{X}$

$$\limsup_{N \rightarrow \infty} \frac{1}{N} \log P_N(C) \leq - \inf_{x \in C} I(x)$$

It turns out that this formulation is general enough to be able to handle most of the examples. The “rate function” $I(\cdot)$ can usually be expressed in a concrete form in terms of the model that produced $\{P_N\}$. One basic tool is the “contraction principle”.

If $F : \mathcal{X} \rightarrow \mathcal{Y}$ is a continuous map, and a large deviation principle holds for $\{P_N\}$ on \mathcal{X} with a rate function $I(x)$ then $Q_N = P_N F^{-1}$ on \mathcal{Y} satisfies a large deviation principle with rate function $J(y)$ given by

$$(2) \quad J(y) = \inf_{x:F(x)=y} I(x)$$

This allows us to recognize a particular example as a contraction of another example on a larger space, but perhaps with a simpler rate function. The difficulty in expressing the rate function J in a concrete fashion may very well be due to the complexity of the variational problem involved in (2).

The theory is mainly a collection of examples and applications that often solve other problems within mathematics. We will survey a few of them.

3. Sanov’s Theorem, Entropy

If Q_N is a product measure $\mu^{\otimes N}$ on \mathcal{X}^N and π_N is the map from $\mathcal{X}^N \rightarrow \mathcal{M}(\mathcal{X})$ sending (x_1, \dots, x_N) to $\delta_N(dx) = \frac{1}{N} \sum_{i=1}^N \delta_{x_i}$, then the induced measure P_N on $\mathcal{M}(\mathcal{X})$ will become concentrated at μ by the law of large numbers. The space $\mathcal{M}(\mathcal{X})$ is given the topology of weak* convergence. Sanov’s theorem [14] asserts that a large deviation principle is valid for P_N with rate function

$$I(\lambda) = H(\lambda, \mu) = \int \frac{d\lambda}{d\mu}(x) \log \frac{d\lambda}{d\mu}(x) d\mu$$

which is defined to be $+\infty$ unless $\lambda \ll \mu$ and $\frac{d\lambda}{d\mu}(x) \log \frac{d\lambda}{d\mu}(x) \in L_1(\mu)$. This is not all that different from the coin tossing we started out with. The multinomial distribution arises when objects are distributed randomly in one of k boxes, the probability of ending in box j being π_j . If N objects are distributed the probability that the counts for the boxes is (n_1, n_2, \dots, n_k) is the multinomial distribution

$$p_N(n_1, n_2, \dots, n_k) = \frac{N!}{n_1! \dots n_k!} \pi_1^{n_1} \dots \pi_k^{n_k}$$

The probability that the ratios $\{\frac{n_i}{N}\}$ are close to $\{p_i\}$ (instead of $\{\pi_i\}$), can be calculated again by Stirling’s formula and leads to a large deviation principle on the space \mathcal{M}_k of probability distributions $\{p_i\}$ on $\{1, 2, \dots, k\}$ with rate function

$$I(p) = \sum_{i=1}^k p_i \log \frac{p_i}{\pi_i}$$

This is of course a special case of Sanov’s theorem, and Sanov’s theorem is a limiting case of this.

Now one can see the connection between Cramèr's theorem and Sanov's theorem. The mean \bar{x} is after all

$$\bar{x} = \frac{1}{N} \sum_{i=1}^N x_i = \int y \delta_N(dy)$$

and the contraction principle applies modulo some technical issues due to possible large values of x :

$$\inf_{\lambda: \int y \lambda(dy) = x} H(\lambda, \mu) = \sup_{\theta} [\theta x - \log \left[\int e^{\theta y} \mu(dy) \right]]$$

4. Tilting

Jensen's inequality states that for any probability measure P

$$\log \int \exp[F(x)] dP \geq \int F(x) dP$$

If P and Q are mutually absolutely continuous

$$P(A) = \int_A dP = \int_A \frac{dP}{dQ}(x) dQ = Q(A) \frac{1}{Q(A)} \int_A \exp \left[-\log \frac{dQ}{dP}(x) \right] dQ$$

and by Jensen's inequality

$$\log P(A) \geq \log Q(A) - \frac{1}{Q(A)} \int_A \left[\log \frac{dQ}{dP}(x) \right] dQ$$

In particular if we want to get a lower bound on $\frac{1}{N} \log P_N(A)$, we pick a suitable Q_N such that $Q_N(A) \rightarrow 1$ as $N \rightarrow \infty$. We can then expect

$$\liminf_{N \rightarrow \infty} \frac{1}{N} \log P_N(A) \geq - \liminf_{N \rightarrow \infty} \frac{1}{N} \int \left[\log \frac{dQ_N}{dP_N}(x) \right] dQ_N$$

We think of this as a "control" problem where we want to change the model that produced P_N to a new model that produces Q_N under which A has nearly full measure. The cost of the control is measured in terms of the relative entropy $H(Q_N, P_N)$ and yields a large deviation lower bound. The converse is true as well. If $P_N(A) > 0$, then the "tilt" $Q_N = P_N^A = P_N|_A$, i.e. the restriction of P_N to A , is clearly concentrated on A and has relative entropy

$$H(Q_N, P_N) = \int_A \log \frac{dQ_N}{dP_N}(x) dQ_N = \frac{1}{P_N(A)} \int_A \log \frac{1}{P_N(A)} dP_N = -\log P_N(A)$$

The importance of this procedure is that, while this particular choice of Q_N is not very useful because we need to know $P_N(A)$, one can try other Q_N that will asymptotically yield the same large deviation rate.

We will illustrate this by some examples. If, in the multinomial case, we want the empirical relative frequencies $\frac{x_i}{N}$ to be in an open set G containing $\{p_i\}$, then we can change the model and let Q_N be the multinomial with cell probabilities $\{p_i\}$ instead of $\{\pi_i\}$. Clearly $Q_N[\{\frac{x_i}{N}\} \in G] \rightarrow 1$ and

$$H(Q_N, P_N) = E^{Q_N} \left[\sum_i x_i \log \frac{p_i}{\pi_i} \right] = N \sum_i p_i \log \frac{p_i}{\pi_i}$$

In the case of Cramér's theorem the underlying distribution μ is tilted to

$$d\lambda_\theta = \frac{1}{M(\theta)} e^{\theta x} d\mu$$

where θ is chosen so that

$$\frac{M'(\theta)}{M(\theta)} = \int x \lambda_\theta(dx) = a$$

The entropy is

$$H(\otimes^N \lambda_\theta, \otimes^N \mu) = NH(\lambda_\theta, \mu) = N[a\theta - \log M(\theta)]$$

and $[a\theta - \log M(\theta)]$ is maximized when

$$a - \frac{M'(\theta)}{M(\theta)} = 0$$

5. Diffusion with Small Noise

A class of problems that have been studied in detail is the perturbation of deterministic equations by a small noise; for instance, Stochastic differential equations in R^d of the form

$$dx(t) = b(x(t))dt + \sqrt{\epsilon} \sigma(x(t))d\beta(t); \quad x(0) = x$$

where β is a d -dimensional Brownian motion and σ is such that $\sigma(x)\sigma(x)^* = a(x)$ is positive definite. As $\epsilon \rightarrow 0$ the distribution $P_{\epsilon,b}$ of the solution will concentrate at the solution of the ODE, $x'(t) = b(x(t))$. If $f(t)$ is any smooth curve in R^d with $x(0) = x$ we can ask for an estimate of

$$P_{\epsilon,b}[x(\cdot) \in B(f, \delta)]$$

in some interval $[0, T]$. In other words is there a large deviation principle for the distribution P_ϵ of the solution x and if so what is the rate function? The work of Schilder [15], Varadhan [16], Glass [9], Ventcel and Freidlin[18] gives the answer as

$$I(f) = \frac{1}{2} \int_0^T \langle a^{-1}(f(t))(f'(t) - b(f(t))), (f'(t) - b(f(t))) \rangle dt$$

where $a^{-1}(x) = \{a^{i,j}\}(x)$ is the inverse of $a(x)$. One can understand the formula through tilting. If we replace the SDE with

$$dx(t) = f'(t)dt + \sqrt{\epsilon}\sigma(x(t))d\beta(t); \quad x(0) = x$$

then as $\epsilon \rightarrow 0$ the measure $P_{\epsilon,f}$ will concentrate at the path $f(t)$. Girsanov formula calculates explicitly the Radon-Nikodym derivative and a simple calculation shows that the relative entropy is given by

$$H(P_{\epsilon,f}, P_{\epsilon,b}) = \frac{1}{\epsilon}I(f) + o(\epsilon^{-1})$$

If $b(\cdot)$ is zero, ϵ is a rescaling of time and the rate function is closely related to arc length and geodesic distance in the metric

$$ds^2 = \sum_{i,j} a^{i,j}(x)dx_i dx_j$$

In particular, for small t , one would expect the transition density $p(t, x, y)$ to behave like

$$p(t, x, y) = \exp \left[-\frac{d(x, y)^2}{2t} + o\left(\frac{1}{t}\right) \right]$$

In other words if a diffusion process is forced to go somewhere in a small time interval it will follow closely a geodesic with probability nearly 1.

6. Gibbs Measures and Equilibrium Statistical Mechanics

For simplicity let us consider in R a large interval $[-\ell, \ell]$. We want put roughly $N = 2\rho\ell$ particles randomly in the interval. But rather than uniformly distributing them in $[-\ell, \ell]^N$ we want to have their joint distribution $Q_{\ell,N}$ to be given by the density

$$Z_{N,\ell}^{-1} \exp \left[-\sum_{i,j} V(x_i - x_j) \right] \Pi dx_j$$

Here $V \geq 0$ is a short range potential and $Z_{N,\ell}$ is the normalizing constant. One wants to take the limit as $N \rightarrow \infty$ keeping ρ fixed. If we take $V \equiv 0$, the limit would be a Poisson point process P_ρ with intensity ρ . In general we would expect to get a stationary point process Q in the limit, with density ρ but with nontrivial correlations. For any stationary process Q , we can calculate the entropy of the restriction of Q^ℓ of Q to $[-\ell, \ell]$, which is a distribution on $\cup_{n=0}^\infty [\ell, \ell]^n$ with densities $q_{n,\ell}(x_1, \dots, x_n)$ relative to corresponding restrictions

$$p_{n,\ell}(x_1, \dots, x_n) = \frac{e^{-2\rho\ell}}{n!}$$

of the Poisson process P_ρ on $[-\ell, \ell]^n$.

$$H_\ell(Q, P_\rho) = \sum_{n=0}^{\infty} \int_{[-\ell, \ell]^n} q_{n, \ell}(x_1, \dots, x_n) \log \frac{q_{n, \ell}(x_1, \dots, x_n)}{p_{n, \ell}(x_1, \dots, x_n)} \Pi dx_j$$

H_ℓ is super-additive and the limit

$$\lim_{\ell \rightarrow \infty} \frac{H_\ell}{2\ell} = \sup_{\ell} \frac{H_\ell}{2\ell} = H_\rho(Q)$$

exists. Roughly speaking $e^{-2\ell H_\rho(Q) + o(\ell)}$ is the probability that in an interval $[-\ell, \ell]$ a realization of a Poisson point process with intensity ρ resembles the stationary point process Q rather than the P_ρ promised to us by the ergodic theorem. For any stationary point process the limit

$$\lim_{\ell \rightarrow \infty} \frac{1}{2\ell} E^Q \left[\sum_{x_i, x_j \in [-\ell, \ell]} F(x_i - x_j) \right] = Q_2(F)$$

exists for functions F with compact support. The limit Q of $Q_{\ell, N}$ that we seek is the minimizer Q over all stationary point processes with density ρ of

$$\inf_Q [Q_2(V) + H_\rho(Q)]$$

The rationale for this goes something like this. If P_n satisfies a large deviation principle on \mathcal{X} with a rate function $I(x)$, and $F(x)$ is a nice function on \mathcal{X} , the contribution for the integral

$$\int e^{-nF(x)} dP_n(x)$$

comes mostly from around the point x , where $F(x) + I(x)$ is a minimum. After all, the probabilities decay locally like $e^{-n I(x)}$ and the combined contribution to the integral from around x is roughly $e^{-n[F(x) + I(x)]}$. It is not hard to conclude that

$$\lim_{n \rightarrow \infty} \frac{1}{n} \log \int e^{-nF(x)} dP_n = - \inf_x [F(x) + I(x)]$$

and that the normalized distribution

$$Z_n^{-1} e^{-nF(x)} dP_n$$

will converge to the δ -function at the minimizer x (provided it is unique). See [12] for a detailed exposition of this point of view.

7. Longtime Behavior of Markov Processes

If X is a finite set and $\pi(x, y)$ is stochastic matrix on $X \times X$ with positive entries, there is a nice rapidly mixing Markov chain $\{x_j\}$ on X with π as transition probability. For any $V : X \rightarrow R$, the limit

$$\frac{1}{n} \log E_x \left[\exp \left[\sum_{j=1}^n V(x_j) \right] \right] = \lambda_\pi(V)$$

exists and just as in the multinomial case

$$I_\pi(p(\cdot)) = \sup_V \left[\sum V(x)p(x) - \lambda_\pi(V) \right]$$

will be the large deviation rate function for deviations from the ergodic theorem. If

$$f_n(x) = \frac{1}{n} \sum_{j=1}^n \mathbf{1}_{x_j=x}$$

is the proportion of time spent at x during $\{1, 2, \dots, n\}$ by the chain $\{x_j\}$,

$$P_x[\{f_n(x)\} \simeq \{p(x)\}] = \exp[-nI_\pi(p(\cdot)) + o(n)]$$

There are various ways of identifying $\lambda_\pi(V)$. The matrix $\pi_V(x, y) = \pi(x, y)e^V(y)$ is not stochastic but has positive entries. It will have, by Frobenius theory, a principal eigen-value $\rho_\pi(V)$ which is positive. All the other eigen-values will be smaller in modulus. The eigen-value with the largest modulus will be simple and have a strictly positive row as well as column eigenfunctions. The expectation

$$E_{x_0} \left[\exp \left[\sum_{j=1}^n V(x_j) \right] \right] = \sum_y (\pi_V)^n(x_0, y)$$

and grows (or decays) exponentially like $[\rho_\pi(V)]^n$. Clearly $\lambda_\pi(V) = \log \rho_\pi(V)$.

We can also identify it by tilting. If we replace the Markov chain $\pi(x, y)$ by a new one $\hat{\pi}(x, y)$ such that $\sum_x p(x)\hat{\pi}(x, y) = p(y)$, then the ergodic theorem will guarantee that after tilting the proportions $\{f_n(x)\}$ will be close to $\{p(x)\}$. The relative entropy, normalized by the number of steps n , is easy to calculate

$$\frac{1}{n} \sum_{x_1, \dots, x_n} \left[\sum_{i=0}^{n-1} \log \frac{\hat{\pi}(x_i, x_{i+1})}{\pi(x_i, x_{i+1})} \right] \prod_{i=0}^{n-1} \hat{\pi}(x_i, x_{i+1})$$

It has as its limit

$$J(\hat{\pi}) = \sum_{x, y} p(x)\hat{\pi}(x, y) \log \frac{\hat{\pi}(x, y)}{\pi(x, y)}$$

It definitely behooves us to minimize $J(\hat{\pi})$ over $\hat{\pi}$ satisfying $\sum_x p(x)\hat{\pi}(x, y) = p(y)$.

$$I_{\pi}(p(\cdot)) = \inf_{\hat{\pi}: p\hat{\pi}=p} J(\hat{\pi})$$

The minimum is attained when $\frac{\hat{\pi}(x,y)}{\pi(x,y)}$ factors as the product of a function of x and a function of y .

$$\hat{\pi}(x, y) = \pi(x, y)e^{V(y)} \frac{u(y)}{\rho u(x)}$$

for some V and $u(y)$ is the row eigen-vector

$$\sum_y \pi_V(x, y)u(y) = \rho u(x)$$

of π_V and $p(x)$ satisfies

$$\sum_x \frac{p(x)}{u(x)}\pi_V(x, y) = \rho \frac{p(y)}{u(y)}$$

making $\frac{p(x)}{u(x)}$ the column eigen-vector. Therefore $p(x)$ is the product of the principal row and column eigen-vectors of π_V .

If we insist that in addition to $\{f_n(x)\}$ being close to $\{p(x)\}$, the proportion of transitions

$$g_n(x, y) = \frac{1}{n-1} \sum_{i=1}^{n-1} \mathbf{1}_{\{x_i=x, x_{i+1}=y\}}$$

be close to $q(x, y)$, then $q(x, y)$ will have to be a probability on $X \times X$ with $\sum_x q(x, y) = \sum_x q(y, x) = p(y)$. We have no choice and the tilt has to be chosen as $\hat{\pi} = \frac{q(x,y)}{p(x)}$. The rate function is explicit

$$I_2(q) = \sum_{x,y} q(x, y) \log \frac{q(x, y)}{p(x)\pi(x, y)}$$

One can reinterpret the optimization as the contraction principle going from probabilities on $X \times X$ based on visits at successive times to probabilities on X involving just the number of visits.

One can try to push this as far as it will go. Let P be a stationary process on X and let $\{x_i\}$ be a realization of length n . We can extend it periodically in both directions to get a periodic orbit of period n under shift and take the orbital measure R_n which is now a random stationary process. Its distribution will be a measure μ_n on the space $\mathcal{M}(X)$ of stationary processes Q on X . As $n \rightarrow \infty$, μ_n will concentrate around P by the ergodic theorem and one can ask for a large deviation result and a rate function. The rate function is universal and should be given by

$$E^Q \left[\log \frac{q(x_0|x_{-1}, x_{-2}, \dots)}{p(x_0|x_{-1}, x_{-2}, \dots)} \right]$$

the average with respect to Q of the conditional relative entropy of x_0 under Q given the past history with respect to a similar object for P . This is too good to be true and it is. The conditional relative entropy is not well defined. $q(x|\cdot)$ is defined a.e. Q while $p(x|\cdot)$ is defined a.e. P . The measures P and Q want to be orthogonal. The way out is to assume conditions on P so that p is well defined everywhere. Since expectation is taken with respect to Q , q being only defined a.e. Q is not a problem. What this means is that in order to have a large deviation principle for P we need to assume some regularity on the conditional distributions $p(x_0|x_{-1}, x_{-2}, \dots)$. For Markov processes this is only an assumption on $\pi(x, y)$. See [6],[7] for details.

8. Particle Systems

Large deviation theory plays a crucial role in the study of certain types of large systems of interacting particle systems. The simple exclusion process is a system of particles on the lattice Z^d or Z_N^d a cube of side N with periodic boundaries. We will deal with the periodic case to make life a bit easier. The state space of the system is $[Z_N^d]^{k_N}$, the locations ξ_i of every particle in the system. The process is a measure Q_N on $D[[0, \infty); Z_N^d]^{k_N}$, i.e. k_N trajectories $\xi_i(t)$ of the particles.

The transitions are that a particle waits for an exponential time and when the clock rings it tries to jump to a new site and if the site is free the jump is executed, otherwise it is disallowed and the particle waits at the original site for another exponential time. The probability of the particle wanting to pick site y to jump to from site x is $p(y - x)$. The probabilities $p(z)$ add up to 1. We assume $p(0) = 0$ and $p(z) = 0$ outside a finite set F . The generator of the process can be written as

$$(Lf)(\dots, z_i, \dots) = \sum_{i,z} (1 - \eta(z_i + z))p(z)[f(\dots, z_i + z, \dots) - f(\dots, z_i, \dots)]$$

where

$$\eta(z) = \sum_{i=1}^{k_N} \mathbf{1}_{\{\xi_i = z\}}$$

is the number of particles at z . This is either 0 or 1 indicating if the site is available or not. There are various possibilities for $p(\cdot)$. But we shall assume $p(z) = p(-z)$. Therefore $\sum z p(z) = 0$. We rescale diffusively and consider

$$R_N = \frac{1}{N^d} \sum_{i=1}^{k_N} \delta_{\frac{\xi_i(N^2 \cdot)}{N}}$$

as a random measure with total mass $\frac{k_N}{N^d}$ on the space $\Omega = D[[0, T]; \mathcal{T}^d]$ for some fixed T . It is viewed as a point in $\mathcal{M}(\Omega)$. Its distribution μ_N is a measure

on the space $\mathcal{M}(\Omega)$. We have speeded up time by N^2 and rescaled space by N . If we start with an initial configuration $\xi_i(0) = x_i$, then

$$\nu_N(t) = \frac{1}{N^d} \sum_{i=1}^{k_N} \delta_{\xi_i(\frac{N^2 t}{N}}$$

tracks the marginals of R_N and is a Markov process with values in $\mathcal{M}(\mathcal{T}^d)$. We assume that $\nu_N(0)$ the initial distribution of particles $\{\xi_i(0)\}$ has a limit. The limit is necessarily given by a density $q_0(y)$ with $0 \leq q_0(y) \leq 1$ and $\bar{\rho} = \lim_{n \rightarrow \infty} \frac{k_N}{N^d} = \int q_0(y) dy$.

The measure valued process $\nu_N(t)$ converges in probability to $q(t, y) dy$ that is a solution of the heat equation

$$\frac{\partial q(t, y)}{\partial t} = \frac{1}{2} \sum_{i,j} C_{i,j} \frac{\partial \rho(t, y)}{\partial y_i \partial y_j}$$

with

$$C_{i,j} = \sum_z \langle e_i, z \rangle \langle e_j, z \rangle p(z)$$

If we start in equilibrium at density ρ and follow the motion of a single particle it diffuses and scales as a Brownian motion with covariance $S_{i,j}(\rho)$ that depends on ρ . The one dimensional nearest neighbor case is the only exception where $\{S_{i,j}(\rho)\} \equiv 0$. Otherwise $S_{i,j}(\rho) \rightarrow C_{i,j}$ as $\rho \rightarrow 0$ and to 0 as $\rho \rightarrow 1$. The measures R_N converge to a $Q \in \mathcal{M}(\Omega)$. Q is a Markov process with total mass $\bar{\rho}$ and $q(t, y)$ for marginals, but the generator of the time dependent Markov Process is

$$(\mathcal{L}_t g)(y) = \frac{1}{2} [\nabla S(q(t, y)) \nabla g](y) + \frac{1}{2q(t, y)} [S(q(t, y)) - C_{i,j}] \nabla q(t, y) \cdot (\nabla g)(y)$$

Note that $q(t, y)$ is also a solution of

$$q_t = \mathcal{L}_t^* q$$

One can ask for a large deviations result. There is one and the rate function is quite explicit. Can be described by tilting. The way to tilt a jump Markov process is to alter the rates. We introduce a small bias, shifting $p(z) \rightarrow p(z) + \frac{c(z, t, \frac{y}{N})}{N}$, the bias depending on time and location. The shift has a cost and an effect. The effect is that the q now solves

$$(3) \quad \frac{\partial q(t, y)}{\partial t} = \frac{1}{2} \sum_{i,j} C_{i,j} \frac{\partial \rho(t, y)}{\partial y_i \partial y_j} - \nabla \cdot b(t, y) q(t, y) (1 - q(t, y))$$

and the limit Q of R_N , has generator

$$\begin{aligned} (\mathcal{L}_t^b g)(y) &= \frac{1}{2} [\nabla S(q(t, y)) \nabla g](y) + \frac{1}{2q(t, y)} [S(q(t, y)) - C_{i,j}] \nabla q(t, y) \cdot (\nabla g)(y) \\ &\quad + (1 - q(t, y)) b(t, y) \cdot (\nabla g)(y) \\ &= (\mathcal{L}_t g)(y) + (1 - q(t, y)) b(t, y) \cdot (\nabla g)(y) \end{aligned}$$

and $b(t, y) = \sum_z c(z, t, y)$. Since c is not uniquely determined by b we can optimize and the optimal cost is

$$J(b) = \frac{1}{2} \int_0^T \langle b(t, y), C^{-1}b(t, y) \rangle q(t, y)(1 - q(t, y)) dt dy$$

If we want to calculate the rate function for large deviations of R_N as a function of Q , then the first step is to determine marginals q of Q . There are many b 's that solve (3) for given q . In addition to matching the density profile

$$E^Q \left[\int_0^T g(t, y(t)) dt \right] = E^{Q_b} \left[\int_0^T g(t, y(t)) dt \right] = \int_0^T \int_{\mathcal{T}} g(t, y) q(t, y) dt dy$$

we try to match the current.

$$E^Q \left[\int_0^T \langle h(t, y(t)), dy(t) \rangle \right] = E^{Q_b} \left[\int_0^T \langle h(t, y(t)), dy(t) \rangle \right]$$

We can attempt this because various Q_b are equivalent to one another and $I(Q) = +\infty$ if Q is not in that equivalence class or b_Q does not exist. If it does, it produces a unique $b = b(Q)$. Then we have $\tilde{Q} = Q_{b(Q)}$. The rate function was established in [13] and is given by

$$I(Q) = J(b_Q) + H(Q, Q_{b(Q)}).$$

9. Super Exponential Estimates

In proving these large deviation results as well as in other contexts the notion of super exponential bounds arise naturally. If we make approximations and want to interchange limits we need to make sure that the error probabilities are irrelevant. They need to be smaller than the exponential rates we are trying to determine.

We will illustrate with two examples. If we want to show that the distribution P_ϵ of Brownian Motion on $C[0, 1]$ with variance ϵ has a large deviation property with rate function

$$I(f) = \frac{1}{2} \int_0^1 [f'(t)]^2 dt$$

we can first approximate the Brownian Motion $x(t)$ by a piecewise linear path $x_n(t)$ and now the large deviation rates come from a Gaussian distribution in a finite dimensional space.

$$P_\epsilon[x(\cdot) \in C] \leq P_\epsilon[x_n(\cdot) \in C^\delta] + P_\epsilon \left[\sup_{0 \leq t \leq 1} |x_n(t) - x(t)| \geq \delta \right]$$

The error probability in this case is controlled by

$$\limsup_{\epsilon \rightarrow 0} \epsilon \log P_\epsilon \left[\sup_{0 \leq t \leq 1} |x(t) - \bar{x}(t)| \geq \delta \right] \leq -\frac{n\delta^2}{2} = C(n, \delta)$$

and $C(n, \delta) \rightarrow -\infty$ as $n \rightarrow \infty$ for every $\delta > 0$. This allows us to interchange the two limits $n \rightarrow \infty$ and $\epsilon \rightarrow 0$.

In many interacting particle systems like the ones we considered, where the number of particles is conserved, it takes a long time for the system to reach equilibrium, which requires the density to be constant. There are two important scales. The microscopic scale, where the interactions take place and the dynamics is defined and the macroscopic scale where the density is measured and the precise distribution of particles in the microscopic scale are “averaged out”. Although this averaging needs to be done only in probability to prove the limits, it still requires methods from large deviations. The precise nature of the distribution of the particle at any time is impossible to compute. The averaging can be justified in equilibrium, because then the distribution is Bernoulli. Large deviations are used to obtain super-exponential error probabilities in equilibrium and then use them to control the error in non-equilibrium.

For instance in the example we considered it would be important to calculate the following error probability. Let $f(\eta)$ be a function that depends on the local configuration $\{\eta(x); x \in F\}$ where F is a fixed finite set $\{z : |z| \leq r\}$. $f_z = \tau_z f$ is the translate of f by the shift τ_z . Let

$$\rho_N(t, x, \epsilon) = \frac{1}{(2N\epsilon)^d} \sum_{z:|z-y| \leq N\epsilon} \eta(z, t)$$

One expects the system to be locally in equilibrium, i.e. if we denote by $\hat{f}(\rho) = E_\rho[f(\eta)]$ the expectation with respect to the Bernoulli distribution with density ρ , the error

$$S = \frac{1}{N^2} \int_0^{N^2 T} \frac{1}{N^d} \sum_{x \in Z_N^d} \left| \frac{1}{(2N\epsilon)^d} \sum_{z:|z-x| \leq N\epsilon} f_z(\eta(t)) - \hat{f}(\rho_N(t, x, \epsilon)) \right| dt$$

has to be small. It is rather difficult to control directly $P[S \geq \delta]$ especially in non-equilibrium and under tilting. However in equilibrium it is not hard. One can use Dirichlet forms and Feynman-Kac formula to get super-exponential bounds and then use the entropy inequality

$$\alpha(A) \leq \frac{H(\alpha, \beta) + C}{\log \frac{1}{\beta(A)}}$$

to control it in non-equilibrium.

10. Large Deviations and Homogenization

Methods from the study of large deviations are useful for carrying out the homogenization of certain nonlinear partial differential equations. For example, suppose $b(x)$ is a periodic function of x and we want to investigate the behavior as $\epsilon \rightarrow 0$ of the solution u_ϵ of

$$u_t + \frac{\epsilon}{2} \Delta u + \frac{1}{2} \|\nabla u\|^2 + \left\langle b\left(\frac{x}{\epsilon}\right), \nabla u \right\rangle = 0; \quad u(T, x) = f(x)$$

We can do a Hopf-Cole transformation and if $u = \epsilon \log v$, then the equation becomes

$$v_t + \frac{\epsilon}{2} \Delta v + \left\langle b\left(\frac{x}{\epsilon}\right), \nabla v \right\rangle = 0; \quad v(T, x) = \exp\left[\frac{1}{\epsilon} f(x)\right]$$

If we change variables $t = \epsilon\tau$, $x = \epsilon y$, then we obtain

$$v_\tau + \frac{1}{2} \Delta v + \langle b(y), \nabla v \rangle = 0; \quad v\left(\frac{T}{\epsilon}, y\right) = \exp\left[\frac{1}{\epsilon} f(\epsilon y)\right]$$

If we consider the SDE

$$dy(t) = b(y(t))dt + d\beta(t)$$

with a periodic b , there is a law of large numbers for $\frac{y(t)}{t}$ and we can ask for the corresponding large deviations result. Let us suppose that there is a rate function $I_b(y)$

$$P_b\left[\frac{y(t)}{t} \simeq y\right] = \exp[-t I_b(y) + o(t)]$$

Then

$$\lim_{\epsilon \rightarrow 0} \epsilon \log v(0, 0) = \sup_y \left[f(y) - T I_b\left(\frac{y}{T}\right) \right]$$

or

$$\lim_{\epsilon \rightarrow 0} \epsilon \log v(0, 0) = \lim_{\epsilon \rightarrow 0} u(0, 0) = \sup_y \left[f(y) - T I_b\left(\frac{y}{T}\right) \right]$$

In fact

$$\lim_{\epsilon \rightarrow 0} u(t, x) = \sup_y \left[f(y) - (T-t) I_b\left(\frac{y-x}{T-t}\right) \right]$$

which is the solution of the homogenized equation

$$u_t + H(\nabla u) = 0; \quad u(T, x) = f(x)$$

with

$$H(p) = \sup_y [\langle p, y \rangle - I_b(y)]$$

The function $I(y)$ can be calculated by tilting. We need to perturb the equation

$$dy(t) = b(y(t))dt + d\beta(t)$$

to

$$dy(t) = c(y(t))dt + d\beta(t)$$

where c is another periodic function. The adjoint equation

$$\frac{1}{2}\Delta\phi - \nabla\dot{c}\phi = 0$$

will have a positive, normalized solution $\phi = \phi_c$ on the period torus. Then the law of large numbers states that

$$\lim_{n \rightarrow \infty} \frac{y(t)}{t} = m(c) = \int c \phi_c dy$$

The tilt has an entropy cost

$$e(c) = \frac{1}{2} \int \|b - c\|^2 \phi_c dy$$

Then

$$I_b(y) = \inf_{m(c)=y} e(c)$$

and

$$H(p) = \sup_c [\langle p, m(c) \rangle - e(c)]$$

See [11] for more details.

11. Some Quenched Large Deviation Results

If we have two independent stationary stochastic processes $\{X_n\}$ and $\{Y_n\}$ with distributions P and Q respectively, sometimes one is interested in the almost sure limit

$$\lim_{n \rightarrow \infty} \frac{1}{n} \log \psi_n(Y_1, Y_2, \dots, Y_n)$$

where

$$\psi_n(Y_1, Y_2, \dots, Y_n) = E^P \left[\exp \left[\sum_{j=1}^n F(X_j, Y_j) \right] \right]$$

If P is a product measure then this is trivial because for any ergodic Q ,

$$\frac{1}{n} \log \psi_n(Y_1, Y_2, \dots, Y_n) = \frac{1}{n} \sum_{j=1}^n \log E^P[\exp F(X_j, Y_j)] \rightarrow E^Q[\log E^P[\exp F(X_j, Y_j)]]$$

Let us assume for simplicity that under P , $\{X_n\}$ is a Markov chain on a finite state space \mathcal{X} , with transition probability $\pi(x, x')$. Then

$$\lim_{n \rightarrow \infty} \frac{1}{n} \log \psi_n(Y_1, Y_2, \dots, Y_n) = \lambda_\pi(Q)$$

exists a.e Q for every ergodic Q . $\lambda_\pi(Q)$ has a variational formula

$$\lambda_\pi(Q) = \sup_{R: \sigma_2 R = Q} [E^R[F(X_0, Y_0) - h(R_\omega; P_{\omega_1} \times Q_{\omega_2})]]$$

Here R varies over all jointly stationary distributions for $\{(X_n, Y_n)\}$ with the distribution of the second component $\{Y_n\}$ fixed at the stationary process Q . R_ω is the conditional distribution of (X_1, Y_1) given the past $\{X_j, Y_j : j \leq 0\}$. The similar conditional probability for $P \times Q$ is $P_{\omega_1} \times Q_{\omega_2}$, where $\omega = (\omega_1, \omega_2)$ represent the past histories $\{X_j : j \leq 0\}$ and $\{Y_j : j \leq 0\}$ respectively. Note that $\lambda_\pi(Q)$ is well defined because although Q_{ω_2} is only defined a.e. Q , any R that appears in the supremum will have the marginal $\sigma_2 R$ equal to Q . On the other hand P_{ω_1} is globally defined by $\pi(x, x')$. Results of this type have been obtained in [1], [2] and [4].

Additional results and some applications will appear in a forthcoming article [10] while [16], [17], [18] and [19] are earlier expositions that contain additional references. In addition the texts [5] and [8] are excellent sources.

References

- [1] Chi, Zhiyi. Stochastic sub-additivity approach to the conditional large deviation principle. *Ann. Probab.* 29 (2001), no. 3, 1303–1328.
- [2] Comets, F. Large deviation estimates for a conditional probability distribution. Applications to random interaction Gibbs measures. *Probab. Theory Related Fields* 80 (1989), no. 3, 407–432.
- [3] Cramèr, H. (1938). Sur un nouveau théorème-limite de la théorie des probabilités. *Actualités Scientifiques et Industrielles* 736 5–23. Colloque Consacré à la Théorie des Probabilités 3. Hermann, Paris.
- [4] Dembo, Amir; Kontoyiannis, Ioannis. Source coding, large deviations, and approximate pattern matching. Special issue on Shannon theory: perspective, trends, and applications. *IEEE Trans. Inform. Theory* 48 (2002), no. 6, 1590–1615.
- [5] Dembo, Amir; Zeitouni, Ofer. Large deviations: techniques and applications. Corrected reprint of the second (1998) edition. *Stochastic Modelling and Applied Probability*, 38. Springer-Verlag, Berlin, 2010.
- [6] Donsker, M. D.; Varadhan, S. R. S. Asymptotic evaluation of certain Markov process expectations for large time. I. II. *Comm. Pure Appl. Math.* 28 (1975), 1–47; *ibid.* 28 (1975), 279–301.

-
- [7] Donsker, M. D.; Varadhan, S. R. S. Asymptotic evaluation of certain Markov process expectations for large time. IV. *Comm. Pure Appl. Math.* 36 (1983), no. 2, 183–212.
- [8] Ellis, Richard S. *Entropy, large deviations, and statistical mechanics*. Reprint of the 1985 original. *Classics in Mathematics*. Springer-Verlag, Berlin, 2006.
- [9] Glass, Michael Steven. *Perturbation of a first order equation by a small diffusion*. Ph.D. Thesis, New York University, 1970
- [10] Kifer, Yuri.; Varadhan, S.R.S. (Under preparation).
- [11] Kosygina, Elena; Rezakhanlou, Fraydoun; Varadhan, S. R. S. Stochastic homogenization of Hamilton-Jacobi-Bellman equations. *Comm. Pure Appl. Math.* 59 (2006), no. 10, 1489–1521.
- [12] Lanford, Oscar E. Entropy and equilibrium states in classical statistical mechanics, in A. Lenard (Ed) *Statistical mechanics and mathematical problems*, in: *Lecture Notes in Physics*, vol 20, Springer Berlin (1973) pp 1-113.
- [13] Quastel, J.; Rezakhanlou, F.; Varadhan, S. R. S. Large deviations for the symmetric simple exclusion process in dimensions $d \geq 3$. *Probab. Theory Related Fields* 113 (1999), no. 1, 1–84.
- [14] Sanov, I. N. On the probability of large deviations of random variables. 1961 *Select. Transl. Math. Statist. and Probability*, Vol. 1 pp. 213–244 *Inst. Math. Statist. and Amer. Math. Soc.*, Providence, R.I.
- [15] Schilder, M. Some asymptotic formulas for Wiener integrals. *Trans. Amer. Math. Soc.* 125 1966 63–85.
- [16] Varadhan, S. R. S. On the behavior of the fundamental solution of the heat equation with variable coefficients. *Comm. Pure Appl. Math.* 20 1967 431–455.
- [17] Varadhan, S. R. S. Some problems of large deviations. *Proceedings of the International Congress of Mathematicians (Helsinki, 1978)*, pp. 755–762, *Acad. Sci. Fennica*, Helsinki, 1980.
- [18] Varadhan, S. R. S. Entropy methods in hydrodynamic scaling. *Proceedings of the International Congress of Mathematicians, Vol. 1, 2 (Zürich, 1994)*, 196–208, *Birkhäuser*, Basel, 1995.
- [19] Varadhan, S. R. S. *Large deviations and entropy*. *Entropy*, 199–214, *Princeton Ser. Appl. Math.*, Princeton Univ. Press, Princeton, NJ, 2003.
- [20] Varadhan, S. R. S. Large deviations. *Ann. Probab.* 36 (2008), no. 2, 397–419.
- [21] Ventcel, A. D.; Freidlin, M. I. Small random perturbations of dynamical systems. (Russian) *Uspehi Mat. Nauk* 25 1970 no. 1 (151), 3–55.

Landau Damping

Cédric Villani*

Abstract

In this note I describe the solution of a longstanding problem in mathematical physics: the extension of the Landau damping from the linearized to the nonlinear Vlasov equation.

Mathematics Subject Classification (2010). 82C40 (82D10, 70F45)

Keywords. Kinetic equations, galactic and plasma dynamics, collisionless relaxation

In 1936, Lev Landau introduced the basic collisional kinetic model for plasma physics, now commonly called the Landau–Fokker–Planck equation. With this model he imported in plasma physics Boltzmann’s notion of relaxation by increase of entropy, or equivalently loss of information.

In 1946, Landau came back to this field with a much more daring concept: relaxation without entropy increase, with preservation of information, even when collisions are neglected. This notion led to the extremely influential idea that conservative partial differential equations may exhibit irreversible features.

Landau’s analysis was not directly based on the relevant kinetic model in plasma physics, the Vlasov–Poisson equation, but only on a linearized approximation. The validity of this approximation in large time has been questioned. A recent work in collaboration with Mouhot [22] fills this gap and thus demonstrates that relaxation is possible in confined reversible systems, without entropy increase nor radiation. In this note I shall describe the main results and the main insights brought by the proof.

*In memory of Paul Malliavin and Michelle Schatzman, who passed away just too soon to attend this conference — with admiration for their mathematical talent, and gratitude for their renewed support.

École Normale Supérieure de Lyon & Institut Henri Poincaré, 11 rue Pierre et Marie Curie, 75231 Paris Cedex 05, FRANCE. E-mail: villani@ihp.jussieu.fr

1. Mean-field Approximation

Large particle systems interacting via long-range collective interactions occur in many situations in physics. Consider the most fundamental situation of classical particles interacting via Newton's equations in \mathbb{R}^d :

$$m_i \ddot{x}_i(t) = \sum_j F_{j \rightarrow i}(t),$$

where m_i is the mass of particle i , $x_i(t) \in \mathbb{R}^d$ its position at time t , $\ddot{x}_i(t)$ its acceleration, and $F_{j \rightarrow i}$ is the force exerted by particle j on particle i . If all masses are equal and the force derives from an interaction potential, in d -dimensional units we obtain, after proper time-rescaling,

$$\ddot{x}_i(t) = -\frac{1}{N} \sum_j \nabla W(x_i(t) - x_j(t)).$$

In applications N can be of the order of 10^{20} , and then such a large system of equations is hopeless. The mean-field limit $N \rightarrow \infty$ transforms this system of many simple equations in just one (complicated) equation. To perform the limit, first rewrite the equations in terms of the empirical measure $\widehat{\mu}_t^N(dx dv) = N^{-1} \sum \delta_{(x_i(t), \dot{x}_i(t))}$:

$$\frac{\partial \widehat{\mu}^N}{\partial t} + v \cdot \nabla_x \widehat{\mu}^N + F^N(t, x) \cdot \nabla_v \widehat{\mu}^N = 0, \quad F^N = -(\nabla W *_{x,v} \widehat{\mu}^N);$$

then take the limit $N \rightarrow \infty$ to get an equation for the limit measure $\mu_t(dx dv)$. Assuming that $\mu_t(dx dv) = f(t, x, v) dx dv$, we can formally simplify by the invariant measure $dx dv$; the result is the **nonlinear Vlasov equation** with interaction potential W . In this model the unknown $f = f(t, x, v)$ is a time-dependent density distribution in phase space (position, velocity), and the equation is

$$\frac{\partial f}{\partial t} + v \cdot \nabla_x f + F(t, x) \cdot \nabla_v f = 0 \tag{1}$$

$$F = -\nabla W *_{x,v} \rho \quad \rho(t, x) = \int f(t, x, v) dv, \tag{2}$$

To escape the discussion of boundary conditions and to avoid dispersion effects at infinity, I shall only consider periodic data, that is, $x \in \mathbb{T}^d = \mathbb{R}^d / \mathbb{Z}^d$.

The most important case of application is the Vlasov–Poisson equation in plasma physics, where heavy ions are treated as a fixed background, $f(t, x, v)$ is the density of electrons, treated as a continuum, and the interaction potential is the Coulomb potential (the fundamental solution of $-\Delta$). Another archetypal interaction is the Newton potential, which differs from the Coulomb potential only by a change of sign and units; the resulting equation

is the gravitational Vlasov–Poisson equation, of considerable importance in astrophysics.

Before going on, let me notice that while the mean-field limit is well-understood for smooth interactions [4, 8, 23], it has never been put on rigorous footing for Coulomb or Newton interactions. For singular potentials the only available results are those of Hauray and Jabin [11], which miss the Coulomb singularity by (a little bit more than) one order, and assume very stringent conditions of uniform interparticle separation at initial time.

2. Qualitative Behavior of the Vlasov Equation

The Vlasov equation (1) is a time-reversible transport equation; it is in some sense Hamiltonian [1] [15, Section 6]. In contrast with the Boltzmann equation, it keeps the value of Boltzmann’s entropy, $-\iint f \log f \, dv \, dx$, constant in time. Its invariances are well-known: preservation of the energy (kinetic energy + potential energy), and preservation of all integrals of f , that is, all functionals of the form $\iint A(f) \, dv \, dx$.

This equation admits many, many equilibria: first, any spatially homogeneous function $f^0 = f^0(v)$ is an equilibrium; next, there is a general recipe to construct inhomogeneous equilibria on $\mathbb{T}^d \times \mathbb{R}^d$, known as BGK (Bernstein–Greene–Kruskal) waves [3]; the theory of these equilibria is still in their infancy in spite of wide speculation.

The long-time behavior of the Vlasov–Poisson equation has been the object of much debate and speculation: does the kinetic distribution converge to an equilibrium by means of conservative phenomena? Which equilibria are stable and which ones are not? Is there a recipe to predict the “most likely” asymptotic equilibria? Is there an invariant measure on solutions of the Vlasov–Poisson equations? These questions are of great interest in particular in astrophysics, since the apparent approximate homogeneity of galaxies cannot be explained by means of the very slow entropy production mechanisms. At the end of the sixties, Lynden-Bell introduced the mysterious notion of (collisionless) **violent relaxation** to solve this paradox [16, 17]; this is still the object of much debate.

In this ocean of conjectures and mysteries about collisionless relaxation, the only little island on which we can set foot, so far, is the **Landau damping**, which holds in the neighborhood of stable homogeneous equilibria, as I shall now explain.

3. Linearization

In the sequel I will use Fourier transform in both x and v variables, writing

$$\hat{f}(k, v) = \int f(x, v) e^{-2i\pi k \cdot x} \, dx, \quad \tilde{f}(k, \eta) = \iint f(x, v) e^{-2i\pi k \cdot x} e^{-2i\pi \eta \cdot v} \, dv \, dx.$$

Let $f^0 = f^0(v)$ be a homogeneous equilibrium. Let us write $f(t, x, v) = f^0(v) + h(t, x, v)$, assume $\|h\| \ll 1$ in some sense, and accordingly neglect the quadratic term in (1). The result is the **linearized Vlasov equation**:

$$\frac{\partial h}{\partial t} + v \cdot \nabla_x h + F[h](t, x) \cdot \nabla_v f^0 = 0, \quad F[h] = -\nabla_x W *_{x,v} h; \quad (3)$$

here $F[h]$ is the force field generated by the distribution h .

Applying the Duhamel formula (considering $F[\cdot] \cdot \nabla_v f^0$ as perturbation of $v \cdot \nabla_x$), then taking the Fourier transform in x and integrating in v yields the *closed equation* on $\rho^1(t, x) = \int h(t, x, v) dv$:

$$\widehat{\rho}^1(t, k) = \widetilde{h}_i(k, kt) + \int_0^t K^0(t - \tau, k) \widehat{\rho}^1(\tau, k) d\tau, \quad (4)$$

where

$$K^0(t, k) = -4\pi^2 \widehat{W}(k) \widetilde{f}^0(kt) |k|^2 t. \quad (5)$$

Appreciate the miracle: the Fourier modes $\widehat{\rho}^1(k)$, $k \in \mathbb{Z}$, evolve in time independently of each other, and satisfy a convolution equation — a simple instance of **Volterra equation**. In a way this expresses a property of complete integrability, which can actually be made more formal [21].

The convolution equation (4) can be studied by means of Fourier–Laplace transform. If (a) $\widetilde{f}^0(\eta) = O(e^{-2\pi\lambda_0|\eta|})$, (b) the Laplace transform (in time) of the kernel K^0 does not approach 1 in a strip $\{0 \leq \mathcal{R}e \xi \leq \lambda_L |k|\}$, and (c) $\widetilde{h}_i(k, \eta) = O(e^{-2\pi\lambda|\eta|})$, then (4) implies exponential time-decay of nonzero modes of the density perturbation: $\widehat{\rho}^1(t, k) = O(e^{-2\pi\lambda'|k|t})$, for any rate $\lambda' < \min(\lambda, \lambda_0, \lambda_L)$. As a consequence the force $F[h]$ decays exponentially fast. This phenomenon discovered in [14] is called **Landau damping**. (Physics textbooks usually focus on λ_L , the Landau damping rate, as dictating the relaxation rate; but λ_0 and λ should not be forgotten in case f^0 and h_i are not entire functions.)

The existence of a positive decay rate λ_L is guaranteed by the analyticity of f^0 and the *Penrose stability condition*, which in dimension $d = 1$ reads

$$\forall \omega \in \mathbb{R}, \quad (f^0)'(\omega) = 0 \implies \widehat{W}(k) \int \frac{(f^0)'(v)}{v - \omega} dv < 1. \quad (6)$$

The multidimensional version is that for any $k \in \mathbb{Z}^d$, the one-dimensional marginal of f^0 along the axis k satisfies this criterion. For instance, this stability criterion always holds true for Coulomb interaction in dimension 3 if f^0 is a radially symmetric distribution. On the contrary, for Newton interaction, even the Gaussian distribution may be stable or unstable, depending on the temperature (or equivalently, up to rescaling, on the size of the periodic box); this is the phenomenon of *Jeans instability*, which qualitatively explains the fact that stars tend to cluster in galaxies rather than spread around uniformly.

The following theorem summarizes the situation; since Landau's original work it has proven and reproven by many authors in various formalisms and with various degrees of precision, generality and rigor [2, 7, 12, 20, 22, 25, 27, 28].

Theorem 3.1 (Landau's damping theorem). *Let $f^0 = f^0(v)$ be an analytic homogeneous equilibrium, with $|\widehat{f^0}(\eta)| = O(e^{-2\pi\lambda_0|\eta|})$, and let W be an interaction potential such that $\nabla W \in L^1(\mathbb{T}^d)$. Let K^0 be defined in (5); assume that there is $\lambda_L > 0$ such that the Laplace transform $(K^0)^L(\xi, k)$ of $K^0(t, k)$ stays away from the value 1 when $0 \leq \operatorname{Re} \xi \leq \lambda_L |k|$. Let further $h_i = h_i(x, v)$ be an analytic initial perturbation such that $\widehat{h}_i(k, \eta) = O(e^{-2\pi\lambda|\eta|})$. Then if h solves the linearized Vlasov equation (3) with initial datum h_i , one has exponential decay of the force field: for any $k \neq 0$, and any $\lambda' < \min(\lambda_0, \lambda_L, \lambda)$,*

$$\widehat{F}[h](t, k) = O(e^{-2\pi\lambda'|k|t}).$$

In particular, $F[h]$ converges to 0 exponentially fast as $t \rightarrow \infty$.

Moreover, Penrose's stability condition (6) guarantees the existence of $\lambda_L > 0$.

Note that high modes decay faster, low modes decay slower. The infrared cutoff imposed by the periodic boundary conditions implies a uniform lower bound on the decay rate of the various modes; if the problem is set in the whole space, the very slow decay of very low spatial frequencies prevents the exponential decay of the force [9, 10].

4. Nonlinear Landau Damping

The impact of Landau's discovery cannot be overestimated: Landau damping nowadays is one of the cornerstones of classical plasma physics [26].

However, half a century ago, Backus [2] raised a serious objection against Landau's reasoning. He argued that the linearization approximation is not justified in large times for the Vlasov equation, because the amplitude of $\nabla_v h(t, x, v)$ grows at least linearly in time, due to the appearance of fast oscillations as $t \rightarrow \infty$; so even if $\nabla_v h$ is initially of size $O(\varepsilon)$, after time $O(1/\varepsilon)$ it will be of size $O(1)$.

O'Neil [24] further predicted that the linearization approximation anyway breaks down on time scales $O(1/\sqrt{\varepsilon})$, where ε is the size of the perturbation; this is well checked on numerical schemes. So if one is interested in larger time scales, the question naturally arises whether damping does hold for the nonlinear Vlasov equation, at least in the perturbative regime near a stable spatially homogeneous equilibrium.

This question seems to pose formidable difficulties: the nonlinear equation does not have the beautiful structure of the linearized equation; moreover the density $f(t, x, v)$ develops fast oscillations which prevent any uniform smoothness bound, a fortiori analytic regularity. Numerical simulations on such

long time scales are not fully reliable, and sometimes subject to controversy. Isichenko [13] argued that the convergence to equilibrium in the nonlinear case should be very slow. However, Caglioti and Maffei [5] proved the existence of some exponentially damped solutions, leaving open the question of their genericity.

The following recent theorem by Mouhot and myself ends the debate:

Theorem 4.1 (nonlinear Landau damping). *Let f^0 be an analytic profile satisfying the Penrose linear stability condition. Further assume that the interaction potential W satisfies*

$$\widehat{W}(k) = O\left(\frac{1}{|k|^2}\right). \quad (7)$$

Then one has nonlinear stability and nonlinear damping close to f^0 . More precisely, there is $\varepsilon > 0$ such that if f_i is an initial datum satisfying

$$|\widetilde{f}_i - \widetilde{f}_0|(k, \eta) \leq \varepsilon e^{-2\pi\mu|k|} e^{-2\pi\lambda|\eta|}, \quad \iint |f_i(x, v) - f^0(v)| e^{2\pi\beta|v|} dx dv \leq \varepsilon$$

and $f(t, x, v)$ is the solution of the nonlinear Vlasov equation (1) with interaction potential W and initial datum f_i , then $F[f](t, \cdot)$ converges exponentially fast to 0 as $t \rightarrow +\infty$. Moreover, $f(t, \cdot)$ converges weakly to an analytic homogeneous equilibrium $f_\infty = f_\infty(v)$.

This theorem is perturbative, and in fact there is convincing numerical evidence that the conclusion should not hold for large perturbations of equilibrium. Nevertheless the strength of Theorem 4.1 is that it theoretically demonstrates the possibility of relaxation to equilibrium without any dissipation or randomness in a non-radiating, time-reversible, entropy-preserving system.

Theorem 4.1 also predicts the existence of a limit distribution $f_\infty(v)$. The constructive nature of the proof of Theorem 4.1 provides a natural approximation scheme for that limit. By time-reversibility there is also a limit distribution in negative times, and one may check that in general it differs from f_∞ , implying that the limit distribution does not depend only on the invariants of the equation.

There is no contradiction between the reversibility of the Vlasov equation and the effective irreversibility of the behavior expressed by Theorem 4.1: the explanation is that although information is preserved for all times, it becomes stored in high-frequency variations of the distribution function in the kinetic variable. This transfer of information from low to high modes acts like a cascade in phase space, which we like to interpret in terms of regularity: the regularity deteriorates in the velocity variable because of the fast oscillations, but at the same time the regularity of the force in the position variable improves with time.

The rest of this text is devoted to a sketchy presentation of the main tools underlying the proof of Theorem 4.1.

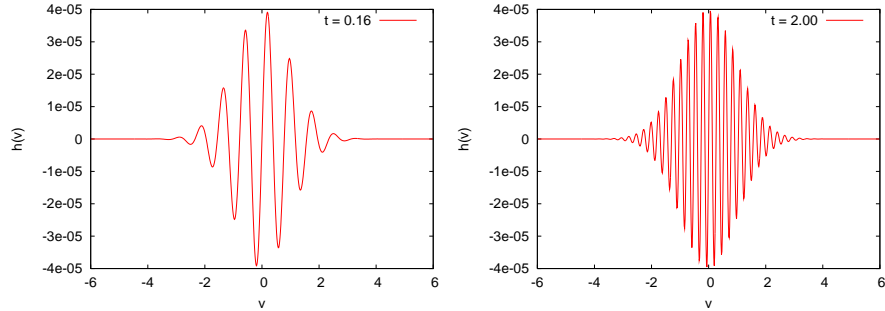

Figure 1. A slice of the distribution function (relative to a homogeneous equilibrium) for gravitational Landau damping, at two different times; notice the fast oscillations of the distribution function, which are very difficult to capture by an experiment. Image courtesy of Francis Filbet.

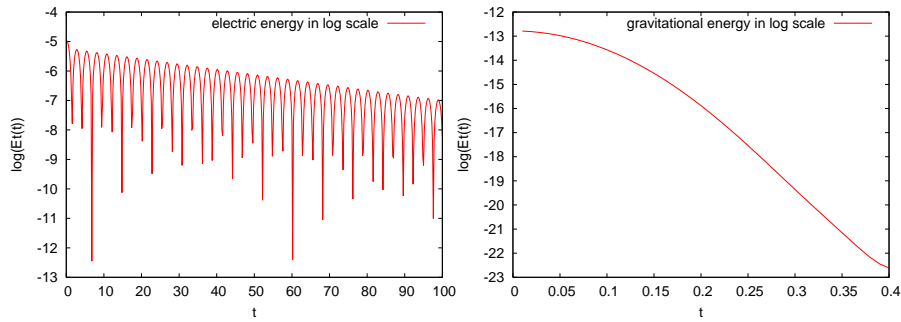

Figure 2. Time-evolution of the norm of the field, for electrostatic (on the left) and gravitational (on the right) interactions. In the electrostatic case, the fast time-oscillations are called Langmuir oscillations, and should not be mistaken with the velocity oscillations.

5. Gliding Analytic Regularity

To estimate solutions of the nonlinear Vlasov equation in analytic regularity, let us look for an analytic norm which behaves well under composition (because the solution of a linear transport equation is obtained by composition with the trajectories of particles); and which does not fear the fast oscillations.

The first problem (composition) is solved by using algebra norms, well-known in certain areas of mathematics: two such norms are defined (say in dimension 1) by

$$\|f\|_{\mathcal{F}^\lambda} = \sum_{k \in \mathbb{Z}} e^{2\pi\lambda|k|} |\widehat{f}(k)| \quad \|f\|_{\mathcal{C}^\lambda} = \sum_{n \in \mathbb{N}_0} \frac{\lambda^n}{n!} \|f^{(n)}\|_{L^\infty}, \quad (8)$$

where $f^{(n)}$ stands for the derivative of order n of f , and $\mathbb{N}_0 = \{0, 1, 2, \dots\}$. The first norm (as it is written) makes sense only for periodic functions, while the second one makes sense for any smooth function on \mathbb{R} . Both satisfy $\|fg\| \leq \|f\| \|g\|$, and as a consequence also satisfy nice formulas for the composition: with obvious notation,

$$\left\| f \circ (\text{Id} + G) \right\|_{\lambda} \leq \|f\|_{\nu}, \quad \nu = \lambda + \|G\|_{\lambda}.$$

The second problem (fast oscillations) is resolved by taking away the contribution of the free transport. This is like a scattering philosophy: to estimate the solution of the perturbed kinetic equation at time t , first evolve it backwards from time t to time 0, using the (reversed) free transport equation.

So the smoothness scale is devised by comparison with the solution of the free transport, and there is an information cascade from low to high modes, as in weak turbulence theory. We call this the **gliding regularity**.

All in all, we introduce a functional norm which mixes the two recipes appearing in (8) (one recipe for the position variable, another one for the velocity variable), and kills fast oscillations by replacing differentiation along ∇_v by differentiation along $\nabla_v + t\nabla_x$:

$$\|f\|_{\mathcal{Z}_{\tau}^{\lambda,(\mu,\gamma);p}} = \sum_{k \in \mathbb{Z}^d} \sum_{n \in \mathbb{N}_0^d} e^{2\pi\mu|k|} (1+|k|)^{\gamma} \frac{\lambda^n}{n!} \left\| (\nabla_v + 2i\pi\tau k)^n \widehat{f}(k, v) \right\|_{L^p(dv)}. \tag{9}$$

By default, $\tau = 0$, $\gamma = 0$ and $p = \infty$.

The five indices might seem a burden, however they provide a lot of flexibility. The parameter τ can be adjusted as one wishes, but should not be too far from the physical time. Please note that the \mathcal{Z} spaces are ordered with respect to the parameters λ, μ, γ and (cheating a bit) p , but not with respect to the parameter τ , at least not with uniform constants.

One can work out nice properties of the \mathcal{Z} norms with respect to product, composition, differentiation, inversion. For instance:

$$\left\| f(x + X(x, v), v + V(x, v)) \right\|_{\mathcal{Z}_{\tau}^{\lambda, \mu; p}} \leq \|f\|_{\mathcal{Z}_{\sigma}^{\alpha, \beta; p}},$$

where $\alpha = \lambda + \|V\|_{\mathcal{Z}_{\tau}^{\lambda, \mu}}$, $\beta = \mu + \lambda|\tau - \sigma| + \|X - \sigma V\|_{\mathcal{Z}_{\tau}^{\lambda, \mu}}$.

Finally, as soon as one has a good decay in velocity space, one may embed the complicated \mathcal{Z} spaces into more naive functional spaces, such as

$$\|f\|_{\mathcal{Y}_{\tau}^{\lambda, \mu}} := \sup_{k, \eta} |\widetilde{f}(k, \eta)| e^{2\pi\lambda|\eta+k\tau|} e^{2\pi\mu|k|}.$$

6. Characteristics

Let us consider the linear Vlasov problem, where particles move in a given force field F , satisfying the same estimates as if it was induced by a solution f of the

free transport. Then the regularity of F improves with time: if \bar{f} is analytic, then

$$\|F(t, \cdot)\|_{\mathcal{F}^{\lambda+\mu}} = O(1)$$

for some $\lambda, \mu > 0$.

Then the solution f is given by the composition of the initial datum, f_i , by the characteristic equations (trajectories). So, to understand the solution of the equation, it is sufficient to understand these characteristics; we define

$$S_{t,\tau}(x, v) = \left(X_{t,\tau}(x, v), V_{t,\tau}(x, v) \right)$$

as the position and velocity at time τ of particles which are transported by the force field F and which at time t will have position x and velocity v . To compare S with the free transport evolution $S_{t,\tau}^0(x, v) = (x - (t - \tau)v, v)$, introduce

$$\Omega_{t,\tau} = S_{t,\tau} \circ S_{\tau,t}^0. \quad (10)$$

That is, start from time τ , evolve by the free dynamics up to time t , and then evolve it backwards by the perturbed dynamics to time τ . As $t \rightarrow \infty$, $\Omega_{t,\tau}$ converges to what is usually called a scattering transform.

A fixed point argument shows the following: if $\lambda' < \lambda$, $\mu' < \mu$ and

$$\|F(t, \cdot)\|_{\mathcal{F}^{\lambda+\mu}} \leq \frac{\varepsilon (\mu - \mu') (\lambda - \lambda')^2}{C},$$

for C large enough, then

$$\|\Omega_{t,\tau} - \text{Id}\|_{\mathcal{Z}_{\tau}^{\lambda',\mu'}} \leq C \varepsilon e^{-2\pi(\lambda-\lambda')\tau} \min\left(t - \tau, \frac{1}{\lambda - \lambda'}\right).$$

This estimate shows that the dynamics asymptotically looks like free transport; it is good because it is (a) uniform as $t \rightarrow \infty$; (b) small as $\tau \rightarrow t$; (c) exponentially small as $\tau \rightarrow \infty$.

The loss of regularity index is roughly of order $O(\varepsilon^{1/3})$; we shall see later how to improve this by playing on the parameters of the norm.

7. Reaction

Now let us consider the force as the unknown, and let the force act on a given time-dependent distribution $\bar{f}(t, x, v) = f^0(v) + h(t, x, v)$. Then the equation is

$$\frac{\partial f}{\partial t} + v \cdot \nabla_x f + F[f](t, x) \cdot \nabla_v \bar{f}(t, x, v) = 0, \quad (11)$$

which formally describes the evolution of a gas of particles which acts by forcing the distribution f , such that there is a flux of particles from distribution f to

distribution \bar{f} , which exactly reacts to the effect of the force and guarantees that \bar{f} is unaffected.

Let us set artificially $f^0 = 0$ to focus on the effect of the nonlinearity. Applying the Duhamel principle, Fourier transform and integration in velocity, we obtain

$$\hat{\rho}(t, k) = \tilde{f}_i(k, kt) + \int_0^t \sum_{\ell} \widehat{\nabla W}(k - \ell) \hat{\rho}(\tau, k - \ell) (\widetilde{\nabla_v f})(\tau, \ell, k(t - \tau)) d\tau. \tag{12}$$

Of course all modes of the density are now coupled; to bound them all together, let us use the norm $\|\rho\|_{\mathcal{F}^{\lambda t + \mu}}$. We assume that $\widehat{W}(k) = O(1/|k|^{1+\gamma})$ as $k \rightarrow \infty$, and that \bar{f} satisfies the same estimates as a solution of free transport:

$$\widetilde{\nabla_v f}(\tau, \ell, k(t - \tau)) \leq C |k|(t - \tau) e^{-2\pi\bar{\lambda}|k(t-\tau)+\ell\tau|} e^{-2\pi\bar{\mu}|k|}.$$

Plugging this bound in (12) leads to an integral equation replacing (4):

$$\|\rho(t)\|_{\mathcal{F}^{\lambda t + \mu}} \leq A(t) + C \int_0^t K(t, \tau) \|\rho(\tau)\|_{\mathcal{F}^{\lambda\tau + \mu}} d\tau, \tag{13}$$

where $A(t) = \sum_k e^{2\pi(\lambda t + \mu)|k|} |\tilde{h}_i(k, kt)|$ remains bounded if λ is small enough, and

$$K(t, \tau) = \sup_{k, \ell} \left(\frac{|k|(t - \tau) e^{-2\pi(\bar{\lambda} - \lambda)|k(t-\tau)+\ell\tau|} e^{-2\pi(\bar{\mu} - \mu)|\ell|}}{1 + |k - \ell|^\gamma} \right). \tag{14}$$

Note that the argument inside the supremum is not uniformly small for large k and large t : a **resonance** phenomenon occurs for

$$k(t - \tau) + \ell\tau = 0,$$

similar to the celebrated *echo experiment* performed by Malmberg and collaborators in the sixties [18, 19].

The bad news about kernel (14) is that it grows linearly with time: $K(t, \tau)$ is in general not better than $O(\tau)$, and $\int_0^t K(t, \tau) d\tau = O(t)$, suggesting a potential superexponential instability. But the good news is that the interaction comes with an important delay. To appreciate this, compare the integral equations $\varphi(t) \leq \int_{t-1}^t \tau \varphi(\tau) d\tau$ (allowing superexponential growth) and $\varphi(t) \leq t \varphi(t/2)$ (imposing subexponential growth).

Also the influence of the singularity of the interaction potential W is seen on (14): the more singular it is, the slower the decay as $|k - \ell| \rightarrow \infty$, the stronger the coupling between different modes.

To estimate solutions of (13) one can use exponential moment estimates. The idea is that

$$\int_0^t e^{-\varepsilon t} K(t, \tau) e^{\varepsilon \tau} d\tau \tag{15}$$

will be smaller if K favors large values of $t - \tau$. In the present case,

$$\int_0^t e^{-\varepsilon t} K(t, \tau) e^{\varepsilon \tau} d\tau \leq \frac{C}{\varepsilon^r t^{\gamma-1}}, \quad (16)$$

for some constants $C > 0$, $r > 0$, and ε arbitrarily small. The important fact is that the bound on the right-hand side of (16) decays as $t \rightarrow \infty$, at least for $\gamma > 1$. One can use this information to show that solutions of (13) cannot grow faster than $O(e^{\varepsilon t})$, where ε is as small as desired; stated otherwise, there is an arbitrarily small loss on the decay rate.

This method accommodates with the presence of f^0 , at the price of technical estimates involving further information on $K(t, \tau)$:

$$\left(\int e^{-2\varepsilon t} K(t, \tau)^2 e^{2\varepsilon \tau} d\tau \right)^{1/2} \leq \frac{C}{\varepsilon^r t^{\gamma-1/2}}, \quad \sup_{\tau \geq 0} \int_{\tau}^{\infty} e^{\varepsilon \tau} K(t, \tau) e^{-\varepsilon t} dt \leq \frac{C}{\varepsilon^r}.$$

As $\gamma \rightarrow 1$, the coupling becomes so strong that the previous method no longer works; instead one can work out a more complicated scheme where all modes are estimated separately, rather than within a single norm. The resulting infinite system of inequalities also provides an arbitrarily small loss on the exponential decay rate.

8. Newton's Scheme

To overcome the loss of decay rate observed in the solution of the linearized problem, we adapt to the present setting the classical Newton algorithm, thus constructing the solution of the nonlinear Vlasov equation as a superposition of solutions of linear equations: $f = \lim_{n \rightarrow \infty} f^n$, $f^n = f^n(t, x, v)$ being defined as

$$f^n = f^0 + h^1 + \dots + h^n,$$

where

- $f^0 = f^0(v)$ is the homogeneous equilibrium;
- h^1 solves the linearized Vlasov equation around f^0 , starting from $f_i - f^0$;
- for any $n \geq 1$, h^{n+1} solves the linear equation

$$\frac{\partial h^{n+1}}{\partial t} + v \cdot \nabla_x h^{n+1} + F[f^n] \cdot \nabla_v h^{n+1} + F[h^{n+1}] \cdot \nabla_v f^n = -F[h^n] \cdot \nabla_v h^n \quad (17)$$

with initial datum $h^{n+1}(0, \cdot) = 0$. The fact that h^n appears quadratically in the right-hand side of (17) formally guarantees that the convergence of the scheme is extremely fast (almost like δ^{2^n}).

The analytic regularity of the solution of this system of equations is first estimated for short times, as in Cauchy–Kowalevskaya theory.

Large time estimates are much more tricky and involve all the ingredients from sections 5 to 7. First one composes by the characteristics induced by $F[f^n]$, in order to get rid of the term $F[f^n] \cdot \nabla_v h^{n+1}$. This does not harm much if we can show that these trajectories are asymptotic to free transport in a suitable sense. Then the reaction analysis and echo control provide the decay of the force, with an arbitrarily small loss on the rate of decay. The overall goal is to set up a virtuous circle: if $F[f^n]$ decays fast, the trajectories will be close to free transport trajectories, and in particular will induce a good mixing of h^{n+1} ; and in turn this will imply a fast decay of $F[h^{n+1}]$.

The implementation of these ideas is particularly technical. Let $\rho_t^n(x, v) = \int h^n(t, x, v) dv$, and $\Omega_{t,\tau}^n = S_{t,\tau}^n \circ S_{\tau,t}^0$, where S^n are the characteristics induced by $F[f^n]$. Two key estimates which are propagated along the scheme are:

$$\sup_{\tau \geq 0} \|\rho_\tau^n\|_{\mathcal{F}^{\lambda_n \tau + \mu_n}} \leq \delta_n, \quad \sup_{t \geq \tau \geq 0} \|h_\tau^n \circ \Omega_{t,\tau}^{n-1}\|_{\mathcal{Z}^{\lambda_n(1+b), \mu_n; 1}} \leq \delta_n, \quad (18)$$

where $b(t) = B/(1+t)$ for some well-chosen parameter $B > 0$. Notice the shift in the indices of the norm of h^n , where the regularity is modulated depending on the final time t : this trick, combined with the decay of the force field, allows to circumvent the fixed loss of regularity due to the composition by the characteristics.

A number of auxiliary estimates are propagated: schematically,

- $\Omega^n \simeq \text{Id}, \quad \nabla \Omega^n \simeq I;$
- $\Omega^n - \Omega^k$ is small and $(\Omega^k)^{-1} \circ \Omega^n \simeq \text{Id}$ as $k \rightarrow \infty$, uniformly in n ;
- $h^k \circ \Omega^n, \nabla h^k \circ \Omega^n, \nabla^2 h^k \circ \Omega^n$ are small as $k \rightarrow \infty$, uniformly in n ;
- $(\nabla h^{n+1}) \circ \Omega^n \simeq \nabla(h^{n+1} \circ \Omega^n)$

A key step is a self-consistent estimate on $\rho^{n+1} = \int h^{n+1} dv$: among other ingredients, the assumption $\widehat{W}(k) = O(1/|k|^2)$ is used there to ensure that $\|\nabla F^{n+1}\| \leq C \|\rho^{n+1}\|$, so that

$$\|F^{n+1} \circ \Omega^n - F^{n+1}\| \leq \|\nabla F^{n+1}\| \|\Omega^n - \text{Id}\| \leq \|\rho^{n+1}\| \|\Omega^n - \text{Id}\|,$$

with the same norm on the left-hand and right-hand sides.

The implementation of the scheme is done in a number of steps at each stage, each of which involves a small loss on the gliding regularity, and large constants. But the latter are all eventually wiped out by the extraordinarily fast convergence of the Newton scheme:

$$\delta_n = O(\delta^{a^n}), \quad 1 < a < 2.$$

In the end remains the *uniform bound*

$$\sup_{n \in \mathbb{N}} \sup_{t \geq 0} \left(\|f^n(t, \cdot) - f^0\|_{\mathcal{Z}^{\lambda, \mu; 1}} + \|F^n(t, \cdot)\|_{\mathcal{F}^{\lambda t + \mu}} \right) = O(\|f_i - f^0\|). \quad (19)$$

From this follows a uniform bound on the solution f , and the exponential decay on the force $F(t, \cdot)$, which in turn implies that $f(t, x + vt, v)$ converges to some distribution function $g(x, v)$. Then $f(t, x, v)$ is asymptotic to $g(x - vt, v)$, and the existence of the asymptotic profile $f_\infty(v)$ follows by the homogenization properties of the free transport.

9. Conclusions

Theorem 4.1 establishes that Landau damping survives nonlinearity: this solves a controversial problem posed half a century ago. The proof of this result is technical and complex, but constructive and based on elementary tools. It provides a hands-on approach of the long-time behavior of the nonlinear Vlasov equation, and singles out the mechanism and the important ingredients behind Landau damping: confinement, mixing, and the Riemann–Lebesgue lemma.

The construction bears several similarities with the Kolmogorov–Arnold–Moser theory [6]. Indeed, the linearized Vlasov equation is completely integrable in some sense, the nonlinearity acts as a perturbation, and the loss of regularity occurring in the solution of the linearized Landau problem can be overcome by a Newton scheme. In our case, the most severe reason for the loss of regularity is the formation of echoes due to the oscillatory nature of solutions. In this sense the proof provides an unexpected bridge between three of the most famous paradoxical statements from classical mechanics of the twentieth century: Landau damping, KAM theory, and the echo experiment. This is all the more remarkable that this bridge only appears in the treatment of the nonlinear Vlasov equation, while Landau was dealing specifically with the linearized equation.

However, in contrast with classical KAM theory, the solution of the linearized Vlasov equation implies a loss of infinitely many derivatives; in Fourier space, this is like multiplication by $e^{|\xi|^\alpha}$ with $0 < \alpha < 1$. This high loss of regularity is one of the main reasons why we are unable to run a classical Nash–Moser regularization scheme and get results in C^k regularity. Instead, we are only able to work in Gevrey regularity, and formulate a guess for the critical regularity: Gevrey-3 (that is, derivatives growing like $n!^3$).

After this theorem, many new problems can be formulated: extension to other models, to inhomogeneous equilibria, long-time behavior of less smooth data, mean-field limit in the perturbative regime. . . A number of old problems also remain wide open, such as the understanding of the statistical theory of the Vlasov equation. When addressing these issues, just as the problem which motivated Theorem 4.1, we must bear in mind that the goal of mathematical physics is not to rigorously prove what physicists already know, but rather through mathematics to get new insights about the physics, and from physics to identify new mathematical problems.

References

- [1] AMBROSIO, L., AND GANGBO, W. Hamiltonian ODE's in the Wasserstein space of probability measures. *Comm. Pure Appl. Math.* 51 (2007), 18–53.
- [2] BACKUS, G. Linearized plasma oscillations in arbitrary electron distributions. *J. Math. Phys.* 1 (1960), 178–191, 559.
- [3] BERNSTEIN, I.B., GREENE, J.M. AND KRUSKAL, M.D. Exact nonlinear plasma oscillations. *Phys. Rev.* 108, 3 (1957), 546–550.
- [4] BRAUN, W. AND HEPP, K. The Vlasov dynamics and its fluctuations in the $1/N$ limit of interacting classical particles. *Commun. Math. Phys.* 56 (1977), 125–146.
- [5] CAGLIOTI, E., AND MAFFEI, C. Time asymptotics for solutions of Vlasov–Poisson equation in a circle. *J. Statist. Phys.* 92, 1-2 (1998), 301–323.
- [6] CIERCHIA, L. A. N. Kolmogorov's 1954 paper on nearly-integrable Hamiltonian systems. A comment on: “On conservation of conditionally periodic motions for a small change in Hamilton's function” [Dokl. Akad. Nauk SSSR (N.S.) 98 (1954), 527–530]. *Regul. Chaotic Dyn.* 13, 2 (2008), 130–139.
- [7] DEGOND, P. Spectral theory of the linearized Vlasov–Poisson equation. *Trans. Amer. Math. Soc.* 294, 2 (1986), 435–453.
- [8] DOBRUŠIN, R. L. Vlasov equations. *Funktsional. Anal. i Prilozhen.* 13, 2 (1979), 48–58, 96.
- [9] GLASSEY, R., AND SCHAEFFER, J. Time decay for solutions to the linearized Vlasov equation. *Transport Theory Statist. Phys.* 23, 4 (1994), 411–453.
- [10] GLASSEY, R., AND SCHAEFFER, J. On time decay rates in Landau damping. *Comm. Partial Differential Equations* 20, 3–4 (1995), 647–676.
- [11] HAURAY, M., AND JABIN, P.-E. N -particles approximation of the Vlasov equations with singular potential. *Arch. Ration. Mech. Anal.* 183, 3 (2007), 489–524.
- [12] HAYES, J. N. On non-Landau damped solutions to the linearized Vlasov equation. *Nuovo Cimento (10)* 30 (1963), 1048–1063.
- [13] ISICHENKO, M. Nonlinear Landau damping in collisionless plasma and inviscid fluid. *Phys. Rev. Lett.* 78, 12 (1997), 2369–2372.
- [14] LANDAU, L.D. On the vibration of the electronic plasma. *J. Phys. USSR* 10 (1946), 25. English translation in *JETP* 16, 574. Reproduced in *Collected papers of L.D. Landau*, edited and with an introduction by D. ter Haar, Pergamon Press, 1965, pp. 445–460; and in *Men of Physics: L.D. Landau*, Vol. 2, Pergamon Press, D. ter Haar, ed. (1965).
- [15] LOTT, J. Some geometric calculations on Wasserstein space. *Comm. Math. Phys.* 277, 2 (2008), 423–437.
- [16] LYNDEN-BELL, D. The stability and vibrations of a gas of stars. *Mon. Not. R. astr. Soc.* 124, 4 (1962), 279–296.
- [17] LYNDEN-BELL, D. Statistical mechanics of violent relaxation in stellar systems. *Mon. Not. R. astr. Soc.* 136 (1967), 101–121.
- [18] MALMBERG, J., AND WHARTON, C. Collisionless damping of electrostatic plasma waves. *Phys. Rev. Lett.* 13, 6 (1964), 184–186.

-
- [19] MALMBERG, J., WHARTON, C., GOULD, R., AND O'NEIL, T. Plasma wave echo experiment. *Phys. Rev. Letters* 20, 3 (1968), 95–97.
- [20] MASLOV, V. P., AND FEDORYUK, M. V. The linear theory of Landau damping. *Mat. Sb. (N.S.)* 127(169), 4 (1985), 445–475, 559.
- [21] MORRISON, P. J. Hamiltonian description of Vlasov dynamics: Action-angle variables for the continuous spectrum. *Transp. Theory Statist. Phys.* 29, 3–5 (2000), 397–414.
- [22] MOUHOT, C., AND VILLANI, C. On Landau damping. Preprint, 2009. Available online at [arXiv:0904.2760](https://arxiv.org/abs/0904.2760)
- [23] NEUNZERT, H. An introduction to the nonlinear Boltzmann–Vlasov equation. In *Kinetic theories and the Boltzmann equation*, C. Cercignani, Ed., vol. 1048 of *Lecture Notes in Math.*, Springer, Berlin, Heidelberg, 1984, pp. 60–110.
- [24] O'NEIL, T. Collisionless damping of nonlinear plasma oscillations. *Phys. Fluids* 8, 12 (1965), 2255–2262.
- [25] PENROSE, O. Electrostatic instability of a non-Maxwellian plasma. *Phys. Fluids* 3 (1960), 258–265.
- [26] RYUTOV, D. D. Landau damping: half a century with the great discovery. *Plasma Phys. Control. Fusion* 41 (1999), A1–A12.
- [27] SÁENZ, A. W. Long-time behavior of the electric potential and stability in the linearized Vlasov theory. *J. Mathematical Phys.* 6 (1965), 859–875.
- [28] VAN KAMPEN, N. On the theory of stationary waves in plasma. *Physica* 21 (1955), 949–963.

A Continuous Path from School Calculus to University Analysis

W.T. Gowers*

Abstract

It is common to describe university-level mathematics as virtually a different subject from school-level mathematics, even when their subject matter overlaps. The difference is particularly keenly felt in analysis, where there is a big contrast between a typical first course in calculus and the more rigorous epsilon-delta approach that one encounters at university.

I shall argue that this appearance is misleading, and that the epsilon-delta definitions and proofs are more intuitive than they might at first appear. I shall focus in particular on the treatment of the real number system, the definition of continuity, and the proof of the intermediate value theorem.

Mathematics Subject Classification (2000). 97-XX

If I was asked to name the two most notable ways in which university-level mathematics differs from school-level mathematics, then I would say that they were *abstraction* and *rigour*. Early courses at university in subjects such as group theory and linear algebra will introduce students to the axiomatic way of thinking, while a first course in mathematical analysis introduces them to rigorous proofs of statements that they will hitherto have justified only informally, if at all. It is often claimed that mathematical analysis is difficult to learn because in order to understand it one must learn to think in a new way. In this short presentation I would like to suggest that there are many connections between the advanced, rigorous way of thinking and the more naive way of thinking that would come naturally to a schoolchild. How these observations should influence the way we teach analysis is far from clear, but it cannot do any harm to draw attention to them.

I plan to discuss three aspects of basic real analysis: the axiomatic approach to the real number system, the definition of continuity, and the proof of the intermediate value theorem. In each case, I shall compare how they are treated

*Royal Society 2010 Anniversary Research Professor, University of Cambridge, UK.
E-mail: W.T.Gowers@dpmms.cam.ac.uk

in a typical analysis course (or textbook) with how they are thought of by an intelligent mathematician who has not yet attended such a course.

First, the real number system. The advanced attitude to the real numbers is this: there exists a complete ordered field; complete ordered fields can be constructed in many different ways; the mere fact that they exist is more important than the precise details of the constructions, since any two complete ordered fields are isomorphic; therefore, it is best to treat the real numbers axiomatically, deducing everything from the axioms for a complete ordered field.

In practice, the fact that the real numbers form an ordered field is kept firmly in the background. We just add them, multiply them, take reciprocals of non-zero numbers, put them in order, and take for granted that they obey the obvious rules. In that respect, a university-level mathematician ends up behaving in a very similar way to a school-level mathematician, who also takes these various rules for granted (the difference being that a school-level mathematician may well not have consciously thought about them).

What really separates the university mathematician from the school mathematician is the use of the completeness axiom (in one of its forms). Or does it? What does the school mathematician use instead? Does the school mathematician even need a substitute, or is the completeness axiom just used for “advanced” statements?

Let us think about a few statements that need the completeness axiom in their proofs. One is the Archimedean axiom, in the form $n^{-1} \rightarrow 0$. To prove this, we say that the sequence is monotone decreasing and bounded below by 0. It therefore converges to a limit L , and a simple argument shows that L has to be 0.

An obvious difficulty for the school mathematician is that the definition of convergence is not part of the school curriculum. But the following equivalent statement is readily comprehensible at school level: for every positive real number x you can find a positive integer n such that n^{-1} is less than x .

Now this last statement comes into the unfortunate category of statements that need a proof, but that appear to the non-expert to be bafflingly simple. Surely, a school mathematician might say, all you have to do is choose enough 0s so that the number

$$0.000\dots0001$$

starts with more 0s than x does, and then take n to be the reciprocal of this number. Or, even simpler, take the reciprocal of x and let n be the next integer above it. The university mathematician might then reply, “Ah, but you are assuming that every real number has a decimal expansion,” or, “How do you know that there is *any* integer above it?” To which the school mathematician will reply that that a real number just *is* an infinite decimal (give or take pedantic qualifications about recurring nines) and that there is obviously an

integer above it because you can just get rid of the fractional part of x and then add 1.

It is clear from these responses that the school mathematician is thinking in terms of a model of the real numbers – defined in terms of infinite decimal expansions – rather than axiomatically. So perhaps there is a profound difference after all.

Before we accept this conclusion, let us think about another statement that a school mathematician finds obvious: that there exists a positive real number x such that $x^2 = 2$. Why is this obvious? I think the (unarticulated) reason is this: they know in principle how to calculate it. They know that it is roughly 1.414, and they know that the reason for that is that 1.414^2 is a tiny bit smaller than 2, while 1.415^2 is a tiny bit bigger than 2. And the next digit is 2 because 1.4142^2 is an even tinier bit smaller than 2, and 1.4143^2 is an even tinier bit bigger than 2. And so on. (Moreover, each new digit can be found by a simple process of trial and error.)

There are a few hidden assumptions here, of course, most notably the continuity of the function $f(x) = x^2$. However, a school mathematician is not too far wrong to find it obvious that the difference between 1.4142^2 and 1.4143^2 is very small, and that as you add more and more digits the corresponding differences will get smaller and smaller. And if one imagines this process going on for ever and producing a number with infinitely many digits, then what one is doing is not very different from a rigorous proof by repeated bisection, except that in this case we do not really need an axiom to see that the monotone sequence $1, 1.4, 1.41, 1.414, 1.4142, \dots$ converges: it converges to the infinite decimal that has these finite decimals as its initial segments.

Note that the way that a school mathematician finds the decimal expansion of $\sqrt{2}$ can easily be converted into a proof that every real number has a decimal expansion. Of course, the resulting proof assumes the Archimedean axiom, so we cannot use decimal expansions to prove the Archimedean axiom. But if we want to prove that a specific number such as $\sqrt{2}$ has a decimal expansion, then it will almost always be easy to find an integer n that is greater than that number, in which case we can do without the Archimedean axiom. So the main use of the Archimedean axiom is in getting us from the axioms for a complete ordered field back to a more concrete picture of them.

Now let me turn to the definition of continuity. Here, surely, is one of the truly difficult concepts that a beginning student of analysis must grasp. To teach it, people often start with a very hand-waving explanation of what a continuous function is – it is a function “whose graph you can draw without taking your pen off the paper” – and they follow it up with a bizarre definition that appears to have nothing to do with this intuitive idea. As if to emphasize that the intuitive idea and the formal definition are different, students are given examples of pathological functions, such as the function that is continuous at all irrational numbers and discontinuous at all rational numbers, and encouraged to be very suspicious of their intuition and use the rigorous definition instead.

Does it have to be this way? I would contend that it does not, since there is a much better intuitive description of what continuity is, one that leads directly to the rigorous definition. It concerns limited-accuracy measurement.

Suppose that a car is being driven along a flat road with its engine switched off and its brakes off as well, and we want to predict where it will be when it comes to rest. To help us, we are given full details of the frictional forces that it is subject to, and, crucially, we are told how fast it is going. Obviously, we are not given the speed as a real number, since we cannot know it exactly: rather, we are given an *approximation* to its speed, accurate to a few decimal places.

Because we are not given the exact speed, our prediction cannot be expected to be exactly accurate either. Is this a problem? In practice, no, because knowing the final position to a good approximation is good enough for practical purposes.

But can our prediction even be expected to be *approximately* correct? Most people feel instinctively that it can. Indeed, they somehow sense that the more accurate the initial data, the more accurate the prediction. Turning things around, they find it intuitively clear that if you insist on a certain level of accuracy for the prediction, then this can be achieved provided the initial data is itself known sufficiently accurately.

Now let us vary the experiment slightly. This time the car is approaching a small bridge. There are therefore three possible outcomes: it can come to rest beyond the bridge, it can come to rest at the top of the bridge, or it can go part of the way up the bridge before rolling back and coming to rest on the same side of the bridge that it is on at the moment. What it cannot do is come to rest on the parts of the bridge where there is any noticeable slope.

Suppose that the maximum speed that will not cause the car to go over the bridge and down the other side is ten miles per hour. And suppose that the car is going at precisely ten miles per hour. Then no matter how accurately we measure the speed of the car, we cannot be sure whether it will come to rest on the top of the bridge or over on the other side. Why is that? Because our measurement will tell us that the speed of the car in miles per hour lies between $10 - a$ and $10 + b$ for two positive numbers a and b , and within that interval there are speeds where the car goes over the bridge and speeds where the car comes to rest on top of the bridge. Thus, however accurate our measurement is, we cannot even say *approximately* what the final position of the car will be.

What is the mathematical difference between the two variants of the experiment? In the first case, the final position of the car depends continuously on its initial speed, and in the other case the dependence is discontinuous. This is easy to see intuitively, and if one tries to explain in detail the thoughts behind one's intuition, then one is led naturally to the conventional definition of continuity. This is not true of the graph-drawing intuition.

Here, very briefly, is another way that one might explain to a school mathematician what continuity is. Just ask them the value of π^2 . They will quickly ask you whether they are allowed to use a calculator, to which you reply yes. So they key in π and then press the x^2 button. The answer comes up: 9.8696044.

You then express surprise: is it really true that π^2 is a rational number? No, they explain, but π^2 is an infinite decimal so the best they can do is give you the first few decimal places. Now you ask how they know that they have worked out π^2 to the first few decimal places. After all, the number they squared was not π itself but an approximation to π such as 3.1415926. They will probably protest that if the approximation to π is good enough, then the approximation to π^2 will be good too. And they will have formulated for themselves a statement that is very close to asserting the continuity of the function x^2 . You can follow this up by asking them how accurately you would need to know π if you wanted to know π^2 to 100 decimal places. In that way, they would, without realizing it, be proving the continuity that they had just asserted.

Note that at no point in this conversation would they need to mention an epsilon or a delta, and yet their conception of continuity would not be importantly different or less rigorous than the standard one taught in universities.

My third example was the intermediate value theorem. This is another result that puzzles people because it seems obvious. However, if we put together the discussion about why 2 has a square root with the discussion of why one can feel confident that keying π into a calculator followed by x^2 gives one a good approximation to π^2 , then we have everything we need for a rigorous proof of the intermediate value theorem in that special case. Furthermore, the resulting proof is close to the proof of the intermediate value theorem by repeated bisection. (It is not quite identical, because the theorem is slightly simpler if the function is monotonic.)

I firmly believe that it would be helpful if more could be done to show that the conventional treatment of basic real analysis is related to, and flows from, the kinds of intuitions that a school mathematician already has about real numbers and functions defined on the real numbers. Of course, there is already a lot to teach, so fitting more into the curriculum may be difficult. But there are no such practical considerations for writers of textbooks. Unfortunately, there are still many textbooks, including newly published ones, that make no attempt to bridge the gap between school and university mathematics. This could, and in my view should, be changed.

Relations between the Discipline and the School Mathematics in Latin American and Caribbean Countries

Carlos Bosch*

Abstract

More than half of the students in the Latin American and the Caribbean region are below Pisa level 1 which means that the majority of the students in our region cannot identify information and carry out routine procedures according to direct instructions in explicit situations.

There have been some good experiences in each country to reverse the depicted situation but it is not enough and this is not happening in all countries. I will talk about these experiences. In all of them professional mathematicians need to help teachers to have the necessary knowledge, and become more effective instructors that can raise the standard of every student.

Mathematics Subject Classification (2010). 97-D10

Keywords. Mathematics education in Latin America and the Caribbean, professional mathematicians, linking mathematicians with mathematics education, initial teachers training, teachers in service, school based National Olympiads.

1. The Situation

Mathematics education is no longer geared toward a minority of students who will pursue a scientific-based career in the future, or to especially gifted or motivated students. Mathematics education is now understood as a right of all students as a specific type of preparation for life. Following the definition used by PISA, the OECD assessment program, “Mathematical literacy is an individual’s capacity to identify and understand the role that mathematics plays in the world, to make well-founded judgements and to use and engage

*Instituto Tecnológico Autónomo de México, Río Hondo 1, Tizapan San Ángel 01000 México. E-mail: bosch@itam.mx

with mathematics in ways that meet the needs of that individual's life as a constructive, concerned and reflective citizen."

In accordance with this new consciousness, countries are increasingly participating in large scale national and international assessments (such as PISA and TIMSS) and making considerable efforts to improve the performance of their educational systems. However, Latin American and Caribbean countries have not achieved the expected results in mathematics.

Research in Mathematics education has clearly shown the difficulty of teaching mathematics, even at the elementary school level. This research reveals that teaching mathematics is a highly demanding mathematical task.

In this context the participation of professional mathematicians in Mathematics education development projects is highly appreciated. It is also very important that they participate in institutional programs that develop this sector and in the corresponding public policy discussions.

Latin American and Caribbean children are not being taught at the level they will need to live their lives and work at their jobs productively. A proof of that are the bad results of the countries in that region on the international evaluations like the Trends in the International Mathematics and Science Study (TIMSS). There are other international evaluations such as the Program for International Student Assessment (PISA) from the OECD which is a survey of students skills and knowledge as they approach the end of compulsory education. It is not a conventional school test. Rather than examining how well students have learned the school curriculum, it looks at how well prepared they are for life beyond school. Among the countries that participate in the 2006 evaluation, Uruguay, the best of them, has nearly 50

2. What Is Happening in our Classrooms?

The very core of education is teaching and that is done by the teachers. The teaching pool in mathematics is inadequate to meet current needs; many classes in this subject are taught by unqualified and under-qualified teachers. The only way to help our children to understand and master mathematics is through teachers who are not only enthusiastic, but also have a deep knowledge of their discipline and have the professional training to teach well. Nor is teacher training simply a matter of preparation; it depends just as much or even more on sustained, high-quality professional development. It is known that the ability to teach is not "something you're born with" (McKenzie report); it can be learned over time. Any way **teachers need to have a deep knowledge of the subject, for this there is no substitute.** We need to teach students not only what to learn but how to learn it. All Latin American and Caribbean countries provide education for almost all young people, but unfortunately the quality is too often poor. Long-term solutions are urgently needed. The region needs better training of its mathematics teachers. In a couple of words, the region needs BETTER TEACHERS.

How can this be achieved?

In many countries in the LAC Region the responsibility for educating teachers may be diffused among many agencies, including Ministries of Education, Teacher Training Colleges and programs, university-level Departments of Education, and, to a lesser extent, university level Departments of Mathematics. Within a single country, including in some found in the English-speaking Caribbean, one may even find all of these agencies producing teachers for their national educational system. So, on one hand, there may be many agencies producing teachers and working to improve their training even though they don't necessarily communicate with each other very much.

On the other hand, except for a relatively few teachers prepared in a mathematics department, **the role of mathematicians in the process is limited or even non-existent throughout most of the region.** This suggests that mathematicians can play a greater role in teacher education and preparation provided that care is taken in their approach.

If, indeed, Mathematics Departments throughout the region simply start "improving" teacher preparation with out proper dialogue and cooperation, they risk fragmenting the process of producing teachers even further. However, if departments engage with various agencies in their country and have real dialogue and cooperation, there is a good chance that they can help to unify and improve the process of preparing mathematics teachers for their country. This second alternative, in which mathematicians enter into meaningful partnerships with other agents, would allow for a mostly untapped resource to be used to help to improve mathematics teaching throughout the region.

3. Good Practices

In spite of having bad results in general, as was said before, one can find examples of important efforts that have shown success in improving Mathematics teaching and results, involving professional mathematicians. Here we will present two cases only; probably the most important cases in the LAC countries but there are other valuable experiences.

Brazil

Many efforts are made in the country but one of the most striking examples in Brazil led by **professional mathematicians** is the Olimpiada Brasileira de Matematica das Escolas Publicas, OBMEP, starting in 2005. In this massive and amazing effort in 2007, around 17 million students from around the country took part, even from the more isolated areas. The Olimpiada Brasileira de Matematica das Escolas Publicas, has three parts or sections.

The first one includes exams, awards, award ceremonies, as in every competition. What distinguishes this Olympiad, however, are initiatives that involve directly professional mathematicians with schools and mathematics teachers in the schools in an effort to raise general standards.

Part two comprises: scholarship programs with 3000 awardees (offered by the government); a Teachers Training Program (lead by professional mathematicians) and a meeting of gold medallists about 300 (at IMPA, Instituto de Matematica Pura e Aplicada).

The third part deals with different publications to support the competition and the training program.

One of the most important parts of this program is the scholarships offered to students with good results and the 197 venues where weekend training is given during one year by professional mathematicians. Apart from taking care of the students the program also involves some teachers and offers them a special course at IMPA

Mexico

The situation in Mexico is no better than in other Latin American and Caribbean countries. State evaluations show that the results are very poor. It is clear that the keystone in mathematics education is the teachers preparation. The Mexican Academy of Sciences started to work with teachers to try to improve their knowledge in mathematics and sciences and also in language.

For the first time the scientists of the Academy are approaching primary and secondary school teachers through the program “La Ciencia en tu Escuela” [Science in your School] to try to change the existing attitude towards mathematics and sciences. This has been a successful and a good quality program. The proofs are, among others, the evaluations that have been made by the State in the rural parts of the country:

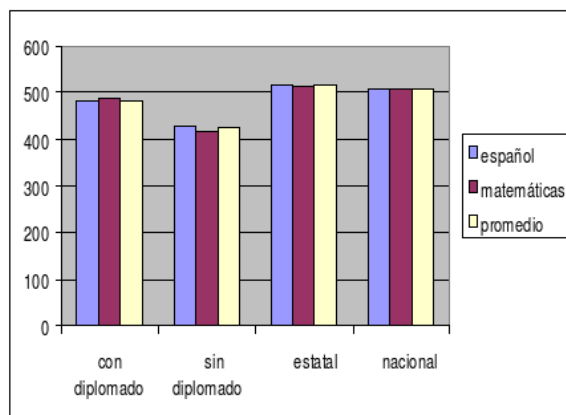

Figure 1. Estado de México (2007)

Español = language, matemáticas = mathematics, promedio = average

The main problem is that in Mexico there are more than one million teachers. To scale the program, the only way we see is to use the internet, so the

program is starting to switch from a teachers-presence education to a semi-virtual schooling followed very closely by counsellors and scientists. The program “La Ciencia en tu Escuela” can be consulted at the page of the Mexican Academy of Sciences (<http://www.amc.unam.mx>)

This program “La Ciencia en tu Escuela” has been so successful that now we are sharing our experience with **Republica Dominicana, Peru, Panama and Guatemala**. We are having workshops, conferences, camps and material exchange.

The main part of the program of the teachers-presence education is a course given all Saturdays of the scholar year during three hours where professional scientists (specially professional mathematicians) work with teachers that almost immediately apply what they learn at the school.

4. Conclusions

There are many competitions and many courses for teachers around the world but the success of the Brazilian and Mexican experiences are that both programs work with professional mathematicians and with teachers that will take what they learn to the classroom. Beside these two cases there have been some good experiences in other countries of that region but this is not enough to reverse the depicted situation. Although it is important to notice that in all of them professional mathematicians are helping teachers to have the necessary mathematical knowledge, and become more effective instructors so they can raise the standard of every student.

Acknowledgement

This is part of the report on “Mathematics Education in Latin America and the Caribbean: a reality to be transformed. March 2009” made by Carlos Bosch (Mexico) - Chair, Lilliam Alvarez Diaz (Cuba), Rafael Correa (Chile), Suely Druck (Brazil), Raymond McEachin (Jamaica) and Juan A. Asenjo (Chile)-Liaison RCLAC With the support of ICSU Regional Committee for Latin America and the Caribbean. The author was partially supported by the Asociación Mexicana de Cultura A.C.

References

- [1] Ball, D. L. (2002) “Knowing Mathematics for Teaching: Relations between Research and Practice”, *Mathematics and Education Reform Newsletter*, Vol. 14 No 3, 1–5.
- [2] Ball, D. L., Hill, H. C., Bass H. (2005) “Knowing Mathematics for Teaching. Who Knows Mathematics Well Enough To Teach Third Grade, and How Can We Decide? *American Educator*, Fall 2005, American Federation of Teachers.

-
- [3] Hill, H. C., Ball, D. L. (2004) "Learning Mathematics for Teaching: Results from Californias Mathematics Professional Development Institutes", *Journal for Research in Mathematics Education*, Vol. 35, No 5, 330–351.
- [4] Hill, H., Ball, D. L., Schilling, S. (2004) "Developing Measures of Teachers Mathematical Knowledge for Teaching", *The Elementary School Journal*, Vol. 105, No 1, 11–30.
- [5] Hill, H. C., Rowan, B., Ball, D. L. (2005) "Effects of Teachers' Mathematical Knowledge for Teaching on Student Achievement", *American Educational Research Journal*, Vol. 42, No 2, 371–406.
- [6] Krauss, Brunner, M., Kunter, M., Baumert, J., Blum, W., Neubrand, M., Jordan, A. (2007), "Pedagogical Content Knowledge of Secondary Mathematics Teachers", *Journal of Educational Psychology*. Krauss, S., (2007), "Wie professionsspezifisch sind das fachdidaktische Wissen und das Fachwissen von Mathematiklehrkräften?" *Beiträge zum Mathematikunterricht bei der Gesellschaft für Didaktik der Mathematik (GDM)*.
- [7] Ma, Liping (1999) "Knowing and teaching elementary mathematics: Teachers understanding of fundamental mathematics in China and the United States" Lawrence Erlbaum Associates, Publisher. Mahwah, to:
- [8] National Mathematics Advisory Panel. *Foundation for Success: The Final Report of the Mathematics Advisory Panel*, U.S. Department of Education: Washington, D.C., 2008.

Live Mathematics and Classroom Processes

R. Ramanujam*

Abstract

There are several ways in which mathematics in school classrooms misses elements that are vital to mathematicians' practice. Here, we wish to emphasize processes such as selecting between or devising new representations, looking for invariances, observing extreme cases and typical ones to come up with conjectures, looking actively for counterexamples, estimating quantities, approximating terms, simplifying or generalizing problems to make them easier to address, building on answers to generate new questions for exploration, and so on. In terms of content area and the methodology of content creation, it may be hard to mirror the discipline of mathematics in the school classroom, but we suggest that bringing these processes into school classrooms is both feasible and desirable. This not only enriches school mathematics but can also help solve problems that are currently endemic to mathematics education: perceptions of fear and failure, and low participation. By way of illustration, we offer examples of classroom interactions that show such processes making for lively mathematical exploration.

Mathematics Subject Classification (2010). Primary 97C70; Secondary 97D40, 97D50.

Keywords. Mathematics education, school mathematics, pedagogy, classroom processes.

*I thank all the school children and their teachers for giving me the experiences on which this article is based, Tamil Nadu Science Forum for organizing such interactions, and my colleagues in the National Focus Group on teaching of mathematics, NCERT, (2005-06) for many insightful discussions. Part of the material here comes from [4]. I thank NIAS (<http://www.nias.knaw.nl>) for a Lorentz Fellowship, this article was written during my stay at NIAS.

The Institute of Mathematical Sciences, Chennai, India. E-mail: jam@imsc.res.in

1. Background

The title of the session *School mathematics and its relation to the discipline of mathematics* sounds suspiciously mischievous. If the relation were one of identity, there would surely be no need to discuss it, so the implication is that the two are distinct but (thankfully) bear some nontrivial relationship to each other.

There is, of course, some difference in terms of objectives. The goal of any discipline as such is to increase the sum total of knowledge, tools and techniques of that discipline and expand its practice. Teaching the discipline in school is not so much for producing competence and expertise in that discipline as for enriching the resources of the child as well as for meeting social goals: a good citizen in a modern society is expected to possess a certain set of skills and capabilities, and it is critical for society to assume the availability of such skills on average to pursue goals of social and economic development. Thus, for instance, poetry is taught for aesthetics as well as for understanding of culture. Chemistry is taught so that the child understands some natural phenomena but also to help the child fit better in an industrial society.

If poetry can be taught without mimicking the way poets create poems, and chemistry can be taught without following the way chemists come up with their solutions, surely mathematics can be taught without classrooms showing little mathematicians at work. Indeed this reasoning applies for any discipline whatsoever. Thus goes the argument.

Unfortunately, such an argument misses several important points. It is not a question of what *can* be done, but of what is the best way to do it. Indeed, the fine arts are best taught mimicking their disciplines. Not only painting and music, but poetry also is most effectively taught by giving the children a taste of the best that these arts have to offer. While competence and expertise in the arts take years to acquire, an **appreciation** can indeed be developed early on, and art teachers do this all the time.

So the question is not: *Does school mathematics resemble the discipline?* but whether it *should* or even whether it *can*.

1.1. *Should* school mathematics resemble the discipline?

School mathematics has some important utilitarian aims. Fluency in arithmetical operations and use of notions like perimeter, area and volume, the ability to understand geometrical shapes in two and three dimensions and the use of basic algebra for setting up and solving linear equations — these are skills long recognized to be useful in social life. It seems reasonable that compulsory education systems include the imparting of such skills in the core curriculum, and mathematics at the primary and upper primary level largely consists of such topics.

If fulfilling these utilitarian objectives were the only goal of mathematics education in school, then indeed there is no reason at all to consider its relation to the discipline of mathematics. A carpenter needs a good understanding of

arithmetic, mensuration and geometry, perhaps a little trigonometry. Indeed, almost any vocation (except that of the physical scientist or technologist) needs only a very small and elementary part of the mathematics that is produced. This core is then best taught in whatever way that is most effective. Viewed from such a perspective, school education needs to bother only with the *products* of mathematics, and only with those products we use in “daily life”; the processes by which mathematics produces them are irrelevant.

But then the goal of mathematics education is more than these utilitarian objectives: in the words of Wheeler ([7]), it is to **mathematize thought**. If mathematics is about anything at all, it is about thinking, and the aim of teaching mathematics is to enrich the inner resources of the child ([5]). For this purpose, the *process* of mathematics is (arguably) more important than its products ([2]). From such a viewpoint, it is indeed necessary that school mathematics bear a strong resemblance to the discipline, albeit at an elementary level.

1.2. *Can school mathematics resemble the discipline at all?*

Another prevalent viewpoint takes the following attitude: even while granting that it will be desirable for school mathematics to reflect the discipline, such a reflection is simply *infeasible*. Some phrase this objection at the level of practice, some deny feasibility even in principle.

On the face of it, this is a reasonable view. The sharp discontinuities between school and undergraduate mathematics and those between university mathematics and research mathematics attest to the difficulty. In fact, these discontinuities are much sharper in the case of mathematics than in other disciplines. Not only the content of discussions, but even the very language of higher mathematics is inaccessible to anyone but the practitioner of the discipline. The standards of rigour expected in the discipline are often considered to be at variance with the psychology of children’s learning.

However, these are by no means insurmountable objections. As we will argue below, there are ways by which school mathematics can indeed access the processes that characterize higher mathematics even while operating in its own realm of language and content. As long as children’s cognitive and physical abilities are taken into account, there can be no problem of infeasibility in principle.

The objection from a practical viewpoint is indeed serious. It is an important comment on the extant mathematics curriculum and pedagogy, as well as the state of teacher preparation ([3]). Looking at the reality, it does seem daunting to view the distance that needs to be travelled before school mathematics can resemble the discipline in any significant way. But that is no reason to refuse the journey altogether.

1.3. Why bother? All this fuss may seem very academic. Why should one bother either way? Let schools decide what mathematics to teach, do so in whatever way they consider best, and let mathematicians work in their own

style. As long as each system delivers results, worrying about the relation between the two is a waste of our energy. Unfortunately, there are concerns expressed all over the world that these systems are not working well, and there is some dissatisfaction about the results. It is against such a background that this discussion becomes relevant.

- Mathematicians complain about the quality of student preparation at the entry level for undergraduate and graduate studies.
- On the other hand, in many modern societies, people at large view mathematics with suspicion, considering it “too difficult” and as causing too much anxiety in children to be acceptable as a compulsory subject of study.
- In many societies, mathematics is considered to be decidedly *uncool* by teenagers and there is much social pressure against mathematics.
- In fiercely competitive societies such as that of the Indian urban educated class, competence in mathematics is equated with success in competitive examinations and this shapes what is taught and how; as a result, even these children, who are greatly encouraged to ‘do well’ in mathematics and attain great proficiency in some aspects of mathematics, come out of school with skills that few mathematicians care very much for.

Much has been written about problems in the school system and how they result in the situation described above. In the Indian context, we merely quote the core issues of concern identified by [4] as problems:

1. A sense of fear and failure regarding mathematics among a majority of children,
2. A curriculum that disappoints both a talented minority as well as the non-participating majority at the same time,
3. Crude methods of assessment that encourage perception of mathematics as mechanical computation, and
4. Lack of teacher preparation and support in the teaching of mathematics.

The report then goes on to make many recommendations for addressing these problems, but an important *direction for action* identified is the need for shifting focus from content to process. The following quote from [4] summarizes the advocated shift:

The content areas of mathematics addressed in our schools do offer a solid foundation. While there can be disputes over what gets taught at which grade, and over the level of detail included in a specific theme, there is broad agreement that the content areas (arithmetic,

algebra, geometry, mensuration, trigonometry, data analysis) cover essential ground.

What can be levelled as major criticism against our extant curriculum and pedagogy is its failure with regard to mathematical processes. We mean a whole range of processes here: formal problem solving, use of heuristics, estimation and approximation, optimization, use of patterns, visualization, representation, reasoning and proof, making connections, mathematical communication. Giving importance to these processes constitutes the difference between doing mathematics and swallowing mathematics, between mathematization of thinking and memorizing formulas, between trivial mathematics and important mathematics, between working towards the narrow aims and addressing the higher aims.

The main aim of this article is to emphasize what is perhaps merely obvious and common sensical to mathematicians: that these processes precisely form the locus of how school mathematics can reflect the discipline of mathematics.

2. Some Experiences

We describe a few experiences in school classrooms which illustrate how such processes can liven up mathematics in school. These are selected from a variety of such experiences, but it is important to note here that they were organized as Math Club activities under the banner of *Tamil Nadu Science Forum*, a voluntary group committed to science and mathematics popularization, especially in rural areas of Tamil Nadu (a state in southern India). This is relevant by implication: the participating children and teachers saw these activities as “fun” and not part of formal curriculum and certainly not something examinations would be based on.

The three accounts below are selected to represent one stage (according to the Indian classification) each: the first is with children at the primary level (age group 6 to 10), the second at the upper primary level (age 11 to 13) and the third at the secondary level (age 14 and 15). But these are really non-rigid in terms of applicability and we have some experience of doing the same activities at later/earlier stages varying the style and content.

2.1. Modular arithmetic. 20 children sit around in a circle, they announce numbers in sequence from 1 to 20, so they know their own position. A book is handed to child number 1, and they play the game with a simple rule: any child who gets the book should pass it on to her/his second neighbour, and this should go on until everyone has got the book at least once.

When the book reaches 19, it doesn't take much for the child to realise that it next gets back to 1. The book goes another circle and is some way into the

third round before an even numbered child complains that she never got it and will never get it. Soon this is clear to everyone.

They next play the game with the rule: pass the book to the *third neighbour*, and now everyone gets the book. It takes some confusion before this is clear to all, but they do realise it. The question why the situation changed elicits some response, but it's unclear.

Fourth and *Fifth* neighbour passing again leave many children out. How many are left out? This gets some answers, nobody is quite sure. But by now there is widespread conviction: 2, 4 and 5 divide 20, that is why everyone did not get the book, whereas 3 does not divide 20, so everyone gets the book.

Before they start the *sixth* neighbour passing, I ask the children to predict: will everyone get the book? The vote is overwhelmingly in favour of 'yes', with the screamed explanation: because 6 does not divide 20. Then they play the game, and slowly the children realise that not everyone is getting the book. Many are astonished. They do it again to verify whether someone was cheating.

What is going on? A few still stick to the "dividing 20 evenly" hypothesis in the face of all the evidence and get shouted down by others. Some other interesting hypotheses are proffered. One child says: "You start from 1 and keep adding 6, you will always get only odd numbers, that is why even numbered people did not get the book." Soon, more children point out that this is true for the +2 sequence and the +4 sequence. This convinces many until someone points out: "But that does not work for 5! Start from 1 and keep adding 5, you will get both even and odd numbers. But it doesn't help!" There is much noise as children are adding up and checking.

One child tells me, "Sir, it is definitely something to do with division!" though he cannot tell what it might be.

I tell him no, point to the (poor) child numbered 20 and claim that *he* is the source of all the problems. I get the stunned child out and ask them to play the game, now with 19 children. And sure enough, whether they try the second, third, sixth, whatever neighbour rule, everyone does get the book.

By now, there is plenty of excitement, and I bring back not only child 20, but another onlooker who is now numbered 21. The game is played, and again some numbers 'work', some do not. The results are available on the board.

Number of children	2	3	4	5	6	7
20	N	Y	N	N	N	Y
19	Y	Y	Y	Y	Y	Y
21	N	N	Y	Y	N	N

Many conjectures fly around but eventually someone proposes that everyone gets the book exactly when the total number (of children) and the neighbour number have no common divisors. This is checked on the table and by playing the game. Various explanations are proposed. One child says: whatever is the common divisor, we can divide the children into that many groups.

The children are then settled in three groups. One group draws a “clock” with hours numbered 1 to 20, another with 1 to 19, and the third with 1 to 21. They then draw the “figures”: arrows starting from 1 and moving to the k^{th} neighbour, for various values of $k > 1$. Beautiful pictures emerge, and children enjoy looking at the variety and intricacy of the closed curves they have drawn.

By now someone in the 20-clock group has realised that moving 15 neighbours forward is the same as going 5 backward. This knowledge, shared with other groups, produces more observations.

The phrase modular arithmetic has not been mentioned at all in the entire afternoon.

2.2. Spanning tree. On the board is a very rough map of Chennai city, with about 20 localities in the city marked with roads connecting them. We see that every area is reachable from every other, and by different routes. The children are told that a cyclone has washed away all the roads. Chennai metropolitan authority would like to rebuild some roads, but rebuilding each road carries a cost (marked on the board). Naturally, the authority would like to rebuild just as many roads as is necessary to connect all areas by some route (however long and indirect that might be). The children are divided into small groups (typically with 4 or 5 children) and asked to come up with suggestions.

Graphs are being drawn in all groups, and the discussion is very lively. Some children are trying arbitrary guesses, some fill in the least expensive edges first and then add others, some start from a node and construct paths. But every group (some sooner, some later) arrives at the conclusion that cycles are always wasteful, phrased in different ways.

The structure of the spanning tree of the given graph is arrived at by every group. What is unclear for any group is how to decide whether what they have done is good enough or whether their solution can be improved. Invariably someone keeps pointing to an alternative choice that might help. One child says in disgust that they must start all over again. Comparing solutions across groups shows that the net cost can indeed be lower. (“See, I said we should include that *xxx* road” “Hey, that is in *our* answer, you cannot use it” “We can’t? Who are you to say so? Is it your father’s road?”)

At the end of the day, each group talks about how they arrived at whatever solution they came up with. The fact that there can be two distinct solutions (with minimum weight), both of which are correct, is a surprise for many children. (“Two correct answers in mathematics!”, exclaims one child.) Invariably, at least one group is able to clearly explain an algorithm that they used to arrive at the solution.¹

Children are fascinated when they hear that finding the fastest algorithm is an open problem. Getting them to understand what it means for a method to be

¹I have seen children come up with Borůvka’s algorithm several times, when the given edge weights were unique.

faster than another is something of a challenge. We never get as far as formal definitions, but some children clearly appreciate the need for such a definition. But they are uniformly surprised that there can be such (“easy”) problems which even famous people find difficult.

2.3. Information hiding² The problem given to the children is the following: some people have gathered in a room, men and women of all ages. A need arises to find the **average age** of all those present. Unfortunately, most people are embarrassed to reveal their age to others. Can you suggest some way by which they can find the average age without anyone finding another’s age? Assume that there are at least 3 persons in the room, and that nobody has any reason to cheat.

Invariably children come up with a solution using suitable props: everyone writes her/his age on a piece of paper and drops it into a box. We can then compute the average easily. This solution is discussed at length and all children find it acceptable.

We then make the problem harder. One aspect of the box-based solution is that we can find not only the average but also the frequency distribution. For every given number, we can find how many people of that age are in the room. One problem with this is the use of *background information*. If my age is 35, and I find that there is only one piece of paper with 35 comes up, then I also know that nobody else in the room is 35 years old. (So if I knew that someone was 35 or 36 years old but unsure which, now I know for certain that (s)he is 36.)

Can we eliminate such information as well? After a very interesting discussion, there is general agreement that the box serves only to compute the sum anonymously. If the box could “announce” partial sums when anyone came near, (s)he could simply add her age to the partial sum. This way, we get only the sum of ages at the end, not the list of ages. From this it is a small step to the following solution: each person receives a chit with the sum got so far; (s)he adds her own age to this number, writes the new sum on another chit of paper and passes it on. Of course, everyone must add their age only once, but this is easily dealt with: seat everyone in a circle, so that everyone gets to add their age exactly once.

The solution is very nice, except for a small problem: the person who starts the process has to give her age to the second person! At this juncture, every class splits into two: those who believe that this is acceptable (after all, only one person’s age is revealed); and those who insist that this is not a solution to the problem at all. Often, there is some heated argument on the issue.

²This was an example I learnt from Mike Fellows; see [1] for a very interesting discussion of *Kid Krypto*.

At this point, this issue is seen to be the heart of the problem: the partial sum is zero when the first person adds her/his age, and hence this age is revealed to the second. How do we make the partial sum non-zero initially?

Amazing as this may seem, even as the solution stares at everyone, it takes some time before one student suggests the obvious: make it non-zero by starting with some non-zero number! At this point, everything moves fast, and the class converges on the solution: start with some number N ; each person adds her/his age in turn. When all are done, subtract N and we have the sum of ages.

Which N is to be chosen? Obviously, the first person should know N and the second should not. Therefore, it has to be a number privately chosen by the first person.

There is a discussion on whether N can be small or large, relative to the ages of people in the room. The discussion moves on to whether the solution ensures what it should. It is easily seen that collusion would destroy the required secrecy: the k^{th} and the $(k+2)^{\text{nd}}$ person can pool in their information to find the age of the $(k+1)^{\text{th}}$ person. But everyone is convinced that this works in the absence of any collusion. Someone notes that there need to be at least three persons in the room.

The question arises: can we **prove** that this procedure achieves what we set out to do? We talk about formalizing the intuitive argument we gave above, but attempts at formalization run into trouble. The only proofs that students have seen have to do with numbers or come from geometry where they already had the required definitions whereas here they need to define new functions and prove statements about them. This turns out to be hard for the class.

The exercise lays the foundation for introducing *one-way functions* and the class gets involved in coming up with them.

3. Live Mathematics

Many more such experiences can be recorded, many involving algebra, number theory, geometry and trigonometry, but also topics like probability and combinatorics which do not figure very much in the Indian school curriculum. But the point of recounting even a few cases here is only to use them for our discussion on school mathematics in relation to the discipline.

A good starting point is acknowledging and delineating the ways in which mathematics in school classrooms often miss elements that are vital to mathematicians' practice. Here, we wish to emphasize processes such as selecting between or devising new representations, looking for invariances, observing extreme cases and typical ones to come up with conjectures, looking actively for counterexamples, estimating quantities, approximating terms, simplifying or generalizing problems to make them easier to address, building on answers to generate new questions for exploration, and so on. We suggest that bringing these processes into the school classrooms is worthwhile, not only to enrich school mathematics

but even more to solve problems that are currently endemic to mathematics education in India: perceptions of fear and failure, and low participation.

In Indian schools, mathematics classrooms tend to be like work-out gyms for group exercising: pre-set exercises are conducted on the blow of a whistle and everyone must go through the motions. Exercises are graded, inexorably moving to greater levels of exertion independent of whether everyone in the group is comfortable or not. There is little room for changing the exercises or for exploring new ways. A few definitely enjoy the process and want tougher exercises, but most merely wait for the bell to ring, signalling the end of exercising.

If we had to point out one single lacuna in the typical Indian school classroom doing mathematics it is this: an entire lack of interaction, either between students and the teacher, or among the students themselves. Hearing children talk mathematics, discuss problems and their solutions and see them work together on problems is indeed unusual. While it is indeed possible to do mathematics without interaction or discussion, in a driven fashion, the range of processes referred to above that constitute the practice of doing mathematics involve interaction and communication. Pedagogy that emphasizes such processes can engage all the children, and thus help many children overcome anxiety as well.

Specifically, the examples illustrate some aspects related to these processes:

- Making conjectures, looking for invariances and looking actively for counterexamples is a very important part of mathematical practice, whereas this is something ordinarily absent from mathematics classrooms in school. The examples serve to restore the primacy of conjecture making during problem solving.
- Building on answers to generate new questions for exploration has to be an integral part of classroom discussion, and this is another way school mathematics can/should mirror the discipline.
- The examples given did not show much of formalization and selection between or devising new representations, but other examples do. Observing extreme cases and typical ones to come up with conjectures is something children can be guided to do, and several children pick up the habit easily.
- Talking, discussing and communicating mathematics is an important part of learning the subject, and the use of informal argumentation, heuristics, pictures and other aids for discussion is an essential part of mathematical practice. Providing such opportunities for children shows how live mathematics can be, rather than a very formal finished product that brooks no room for disagreement.

It is important to note that the discussions mentioned here were all in the *math club mode*, and hence not considered to be part of the curriculum. This meant that the shadow of assessment did not loom large over the exercise

and children felt free to participate. Indeed, many pedagogic and curricular innovations perish at the altar of tests and evaluation. Teachers find processes hard to evaluate and hence do not give them importance. It is easy to evaluate answers and the “steps” used by students to arrive at them, but how can a teacher evaluate discussions, communication, use of heuristics, formulation of conjectures etc? This is a serious problem, and unless the assessment culture in schools can accommodate process evaluation, it is highly unlikely that the kind of interaction and exploration discussed here would become commonplace.

Another important point is that most of schoolwork consists of fairly routine work and instances of exploratory, open-ended problems that allow a multiplicity of approaches and solutions are hard to come by. So one may be accused of picking convenient examples that teachers can't have the luxury of working with. This is true to a limited extent, but the sad reality is that current classroom practice falls far short of what is possible within the extant curriculum. Indeed, it can be argued that a curriculum that gives primacy to processes of the kind discussed here would be so structured as to make these examples routine.

It is also relevant to note that the shift we advocate requires far greater teacher preparation and support than currently available. Teachers have access to few exercises that are exploratory, and lack models for guiding children through uncertain mathematical terrain. Their own foundations with regard to some of the concepts involved may be not strong enough, and few systemic mechanisms exist for them to strengthen their foundations on the job. Also lacking are networks of support that provide such resources on a dependable basis.

Lastly, it is not incidental that the chosen examples come largely from *finite mathematics*, a domain that is mostly neglected in school curriculum in India. Combinatorics, discrete mathematics, graph theory and probability tend to require little background at an introductory level and children who have difficulties with other areas (such as trigonometry) can easily get into these, but such opportunities are few in the curriculum. We end with a quote from Thurston ([6]) that underlines this need:

The long-range objectives of mathematics education would be better served if the tall shape of mathematics were de-emphasized, by moving away from a standard sequence to a more diversified curriculum with more topics that start closer to the ground. There have been some trends in this direction, such as courses in finite mathematics and in probability, but there is room for much more.

References

- [1] M. Fellows and N. Koblitz, Combinatorially based cryptography for children (and adults), Feb 1993. (available from <http://www.ccs3.lanl.gov/mega-math/write.html>)

-
- [2] H. Freudenthal, *Mathematics as an educational task*, Dordrecht: D. Reidel Pub., 1973.
- [3] P.C. Moreira and M.M. David, Academic mathematics and mathematical knowledge needed in teaching practice: some conflicting elements, *Journal of Math teacher education*, 11, 23–40, 2008.
- [4] Position paper on teaching of mathematics by the national focus group, National curriculum framework – 2005, National council for education, research and training, 2006. (available from http://www.ncert.nic.in/html/focus_group.htm)
- [5] G. Polya, The goals of Mathematical education, *ComMuniCator, the magazine of the California Mathematics Council*, 1969.
- [6] William Thurston, Mathematical education, *Notices of the American Mathematical Society*, 37, 844–850, 1990.
- [7] David Wheeler, Mathematization Matters, *For the Learning of Mathematics*, 3, 1; 45–47, 1982.

Mathematical Knowledge in Processes of Teaching and Learning at School - Its Specific Nature and Epistemological Status

Heinz Steinbring*

Abstract

Mathematical knowledge as object of teaching-learning processes undergoes changes in its epistemological status. In primary and secondary schools:

- mathematics teaching does not aim at training mathematical experts but contributes to the students' general education to become politically mature citizens (expert knowledge vs. knowledge in everyday settings)
- mathematical knowledge cannot be conveyed as a ready made product but it develops in a genetic manner by students' own activities (Mathematics as Product vs. Process, Hans Freudenthal)
- mathematical concepts (i.e. number, probability) cannot be introduced by formal definitions, consistent axioms or defining equations, but receive their meaning by referring to (different embodiments of) structures, patterns and relationships. The epistemological particularities of mathematical knowledge in teaching-learning processes will be elaborated by using elementary examples of basic mathematical concepts.

Mathematics Subject Classification (2010). Primary 97C60; Secondary 97D20.

Keywords. epistemology, school mathematics, culture of the mathematics classroom

*University of Duisburg-Essen, Germany. E-mail: heinz.steinbring@uni-due.de

1. What distinguishes mathematical knowledge in the discipline for researching experts and in general education for students learning mathematics?

In a socio-scientific empirical study, Bettina Heintz (2000) has elaborated the modern mathematical proof as the decisive tool for the increasing unambiguity in the professional communication of mathematics researchers. Her analysis shows that a changing concept in the relation between the 'objects' and the 'conceptual structures' has been essential in the history of mathematics. "In the course of the 19th century, the 'naïve abstractionism' of earlier mathematics was overcome and replaced by objects, which are defined in an exclusively mathematically-internal way. This work on the concepts had also become urgent because mathematicians increasingly use concepts, which could no longer be understood as idealisations or abstractions arising from empirical experience, but had an exclusively fictional character. . . . In the course of this 'theoretisation' (Jahnke 1990) or 'deontologisation' (Bekemeier 1987, p. 220) of mathematics, concepts, which until then had been postulated as self-evident, were successively questioned and transferred into an explicit system. . . .

In the course of this conceptual reflection and reconstruction, essential parts of mathematics lost their natural and illustrative character. Those mathematicians who back then breached tradition and put theoretical, as orthodox critics claimed, 'artificial' constructs in the place of the 'natural' given, were still fully aware of the breach they conducted" (Heintz 200, p. 263, 264).

Abandoning the given empirical, illustrative *objects* and constructing idealised mathematical objects by means of defining conceptual *relations* made a strict, doubtless basis for reasoning on which the unambiguity of mathematical argumentation could develop and thus became a precise communicative body of rules between professional mathematicians (Heintz 2000, p. 221). Given objects and immediate view can be interpreted in many ways and can lead to opposite conceptions. "Even when arguments are deductively constructed and argue with the help of logical rules, when these arguments require a common knowledge and rely on intuition and visualization they are more at risk of dissent than a formal argumentation which one can hardly avoid even if it is contrary to intuition and experience." (Heintz 2000, p. 274).

Even though ontological or idealised object features do not play an explicit role within official professional mathematical communication, i. e. within the frame of the well-rehearsed communicative body of rules of proof (cf. Heintz 2000, p. 221), one can assume that every single mathematician in his consciousness or in his private world of thought (Heintz 2000, p. 220 ff.) does not avoid such conceptions about the mathematical 'object' completely when working on mathematical argumentations.

Within the professional mathematical communication, unambiguous conceptual structures and relations take precedence. "In contrast to content-related axiomatic, formal axiomatic avoids a qualification of the axioms as regards content. . . . Axioms are conceptions of a hypothetical kind, whose truth of content

is not up for debate. Axioms are true if no contradiction arises from them, and the same is true for the existence of mathematical objects..." (Heintz 2000, p. 265).

Such a strictly professional communication, aiming at abstract structures, is not a priori possible for students who stand at the beginning of learning and understanding mathematics. The learning student cannot be directly compared to a professional researching mathematician. A mathematical expert has long years of experience in mathematical communication with colleagues and has acquired routine in the interactive negotiation of the correctness of a mathematical thesis, by means of using the communicative body of rules of formal proof. Also, such professional communications aim at the consistent mathematical product in question in a comparably direct way. The learning student, however, is faced with the demand of developing and then perfecting such forms of mathematical communication together with his fellow students; this process of development is essentially influenced by cultural aspects of the instruction process, by subjective instruction conditions, by cognitive means, by exemplary and situative mathematical frames and interpretations, and therefore, diversity and ambiguousness in understanding and interpreting mathematical knowledge receive priority within the processes of developing, learning and imparting mathematics (cf. Steinbring 2009, pp. 187ff).

As opposed to professional mathematical communication, instructional mathematical communication must carry out a different weighting when it comes to the relation between 'conceptual structures' and 'object'. This is because mathematics instruction is also about introducing the students to an insightful participation in the specific forms of mathematical communication. The self-evident and problem-free use of the well-rehearsed communicative body of rules remains and is a long-term goal to be aimed at by the learning student on his way of becoming a mathematically thinking and communicating person. For this purpose, the particular conditions of the developing communication of learning students within mathematics instruction must be reconstructed with a focus on the particular characteristics of mathematical communication.

If for the professional mathematician the conceptions about the ideal mathematical object are of a rather private nature and reserved to his individual world of thought, for the beginning learner, concrete, illustrative conceptions about the mathematical object as regards content are an important first basis of understanding for developing conceptual structures and relations, and such illustrative conceptions must be reflected together in the classroom communication in an explicit way.

On this basis of an illustration-bound interpretation of mathematical knowledge, an access to, an understanding and a use of mathematics as it is necessary for politically mature and active citizens in a modern society can develop for the broad majority of learning students who will not become mathematical experts later on. A mathematical layperson must have learned such mathematical competences, which allow him to question mathematical statements, models and

uses within his social, economic, political etc. context critically and in a general yet mathematically competent way. Students must in their later lives as mature citizens be able to communicate with mathematical experts as well as to ask critical questions and to understand and evaluate the expert answers. (cf. Fischer 2001; Wille 2002).

2. Mathematical knowledge as a ready made *product* or as a *process* of students' own learning activities?

Freudenthal (1973) has emphasized the process character of mathematics for learning in a paradigmatic way: "It is true that words as mathematics, language, and art have a double meaning. In the case of art it is obvious. There is a finished art studied by the historian of art, and there is an art exercised by the artist. It seems to be less obvious that it is the same with language; in fact linguists stress it and call it a discovery of de Saussure's. Every mathematician knows at least unconsciously that besides ready-made mathematics there exists mathematics as an activity. But this fact is almost never stressed, and non-mathematicians are not at all aware of it" (Freudenthal 1973, p. 114).

Mathematics, as an activity, implies that learning becomes an active process in the construction of knowledge. "The opposite of ready-made mathematics is mathematics in *statu nascendi*. This is what Socrates taught. Today we urge that it be a real birth rather than a stylized one; the pupil himself should re-invent mathematics. . . . The learning process has to include phases of directed invention, that is, of invention not in the objective but in the subjective sense, seen from the perspective of the student" (Freudenthal 1973, p. 118).

Such a conception that mathematical knowledge is not appropriately characterised when it is seen mainly as a finished product, and when therefore the side of the mathematical activity and process is neglected, also plays an important role in the context of mathematical research and in the history of mathematics. For the learning of mathematics, however, the perspective that an already elaborated and finished mathematics is delivered to the children, sometimes dominates.

In order to understand and to realize Freudenthal's request for the learning of mathematics in school, it is helpful to understand the respective characteristics of the cultural context in which mathematics development processes and activities take place. The concept of the cultural surroundings or the mathematical culture is intended to help illuminate the question about the particular epistemological status of mathematics in school teaching and learning processes.

Different authors have highlighted the importance of the culture concept for scientific mathematics as well as for school mathematics (Wilder 1981, Bishop 1988). Wilder (1986) characterises the concept of culture as follows:

"A culture is the collection of customs, rituals, beliefs, tools, mores, etc., which we may call cultural elements, possessed by a group of people, such as a primitive tribe or the people of North America. Generally it is not a fixed thing but changing with the course of time, forming what can be called a 'culture

stream'. It is handed down from one generation to another,..." (Wilder 1986, p. 187).

The use of symbols as well as the way of reading and interpreting them represent a characteristic trait of every culture. "Without a symbolic apparatus to convey our ideas to one another, and to pass on our results to future generations, there wouldn't be any such thing as mathematics – indeed, there would be essentially no culture at all, since, with the possible exception of a few simple tools, culture is based on the use of symbols. A good case can be made for the thesis that man is to be distinguished from other animals by the way in which he uses symbols. . . ." (Wilder 1986, p. 193).

The mathematical signs, symbols, formulas, diagrams and visual representations have an essential meaning within the different mathematical cultures. During the long development of the socio-historical culture, the development of mathematical signs and symbols as well as changes in their use and their interpretations can be observed (Steinbring 2009, p. 21ff). Within the professional culture, mathematical symbols are used in an unequivocal and well-defined way by the participants in the common communication (see Heintz 2000). Within the classroom culture the students are introduced to the use of mathematical signs and symbols; a variety and sometimes ambiguousness of emerging mathematical interpretations and of mathematical knowledge can be observed.

For learning mathematics, it is important to distinguish between the cultural conditions of professional mathematical research practice and the cultural conditions within schools and in mathematics instruction. Mathematics instruction in school cannot be understood simply as a teaching and learning activity, which is determined and regulated by scientific mathematics in a definite way. Mathematics instruction represents an autonomous culture, with a particular and independent type of (school) mathematical knowledge and mathematical language. It is a particular culture in which understanding and knowledge development take place in a self-referential way (see Bauersfeld 1982; 1988; Voigt 1998).

"Participating in the process of a mathematics classroom is participating in a culture of mathematizing. The many skills, which an observer can identify and will take as the main performance of the culture, form the procedural surface only. These are the bricks of the building, but the design of the house of mathematizing is processed on another level. As it is with culture, the core of what is learned through participation is *when* to do *what* and *how* to do it. . . . The core part of school mathematics enculturation comes into effect on the meta-level and is 'learned' indirectly" (Bauersfeld, cited according to Cobb 1994, p. 14).

The interactive development of mathematical knowledge and understanding in general instruction takes place within a particular culture with its own interpretation of mathematical symbols and within this culture it requires particular learning and instruction activities in order to realize (school) math-

ematical knowledge adequately as a process (Freudenthal 1973; Steinbring 2009).

3. Mathematical concepts as central knowledge elements in school mathematics: Based on formal definitions or developed in processes of generalization?

Do the formal definitions contain all of the meaning of mathematical knowledge and mathematical concepts in school mathematics? Can an elementary mathematical theory be deducted precisely and in all its details out of defined basic concepts? Often one can find the thesis that the learning and the acquisition of mathematical knowledge is particularly successful if the knowledge elements are clear and unequivocal, and if the knowledge building is constructed logically and the course of learning is oriented along the deductive structure of the knowledge. According to such a conception, the mathematical knowledge in particular would play a central role in learning scientific knowledge.

This leads to the following question: Is the finished, consistent mathematical knowledge that has been developed over thousands of years and is based on a solid axiomatic foundation at the same time the best basis for the learning process of the knowledge at school?

Two elementary examples – the number concept and probability – will serve to point out that an insightful understanding in school mathematical learning processes cannot start on the current foundations of scientific mathematics. An appropriate interpretation of the specific epistemological character of the solid, abstract axiomatic foundations of scientific mathematics – i. e. an appropriate theoretical description of their specific epistemological character – requires experience and proficiency in scientific knowledge as well as with scientific arguments and proofs, which a beginning mathematics learner does not have, but which he has to learn parallel with the mathematical knowledge.

The elementary concept of the natural number surely cannot be introduced and understood in elementary school on the basis of the Peano axioms. An initial understanding of numbers for young students consists in experiences with the activity of counting. Numbers as quantities in order to count things from the children's experience is a self-evident first essential justification for the mathematical number concept. Such empirically concrete foundations of elementary mathematical concepts are common in elementary school. "... especially in elementary school, the meanings of symbols (signs) are related to empirical issues (numerals to materials, geometrical terms to the physical space, etc.)." (Voigt, 1994, p. 176).

The empirical relationship of numbers to objects in the real world could be a necessary and helpful beginning for the introduction into the number concept; but at the same time it could be later a severe obstacle for the development of structural arithmetical and algorithmic strategies of a comprehensive number concept. Contrary to the empirical use of the number concept in mathematics teaching, where numbers are conceived of as *numbers of objects* or as *names*

of sets, this empiristic conception is fundamentally criticized from a philosophical and epistemological perspective. P. Benacerraf (1984) demonstrates by a philosophical and logical argumentation that numbers cannot be defined in a universal and definite manner by reduction to objects given unequivocally (objects existing in reality or mathematical objects as sets). The central consequence of this analysis is that numbers cannot be objects nor can they be names for objects.

“I therefore argue, . . . that numbers could not be sets, that numbers could not be objects at all; for there is no reason to identify any individual number with any one particular object than with any other (not already known to be a number)” (Benacerraf, 1984, pp. 290/1.).

But if numbers are no objects what else they are then? “To be the number 3 is no more and no less than to be preceded by 2, 1, and possibly 0, and to be followed by Any object can play the role of 3; that is any object can be the third element in some progression. What is peculiar to 3 is that it defines that role - not being a paradigm of any object, which plays it, but by representing the relation that any third member of a progression bears to the rest of the progression. Arithmetic is therefore the science that elaborates the abstract structure that all progressions have in common merely in virtue of being progressions. It is not a science concerned with particular objects - the numbers” (Benacerraf, 1984, p. 291).

Which important orientation could this philosophical interpretation offer for elementary arithmetic instruction in elementary school? Mathematical knowledge is ultimately abstract and characterised by varied structures. But in school, the learning process cannot start with abstract, axiomatic definitions. Yet, from the very first, one should keep in mind that for instance natural numbers cannot be taken as a basis by means of concrete things or empirical features. This dilemma between abstract formal definition and an insightful interpretation of numbers which necessarily refers to concrete things can only be dealt with if the material for illustrating and representing numbers is used in a way that the concrete material and its concrete features do not themselves ‘define’ the numbers, but rather in a way that makes actively constructed relations and structures within the material the basis for a theoretical foundation of numbers. In this way, school mathematics can, from the very beginning, become an elementary science of structures and patterns (Devlin 1997; Wittmann 2003), in which the development of the number concept, following on to fractions, to negative, rational and real numbers happens by means of an increase in structures and relations.

Elementary probability theory offers a further example for the analysis of basic epistemological problems of school mathematical knowledge. Historical and epistemological research about the development of the concept of probability reveal that the relation between the *foundation of a theory and its development* is complex and difficult and cannot be understood simply as a logical-deductive process.

From the very beginning, probability theory focuses on analysing and modelling a fundamental polarity: The dichotomy between *chance* and *regularity*. The concept of probability acquires its specific function in such situations, in which it is no longer possible to make exact prognoses about future events based on strictly causal connections. In these situations, one is trying to achieve certain grades of certainty with the help of probability (Steinbring 1980).

In early history of probability, simple, ideal situations are given in the form of games of chance, in which a direct form of randomness as well as a concrete structuring of law like aspects in the physical symmetry of chance devices and their use became manifest (cf. Hacking 1975, Maistrov 1974). The throwing of a die represents a natural form of randomness and disorder, for which possibilities of a regular model were offered simultaneously by means of the supposedly ideal symmetry. Largely not using mathematically precise definitions, those (ideal) games of chance constituted a ‘concrete’ elementary concept of probability for the prognosis of the occurrence or non-occurrence of certain events and for the determination of gradual certainties.

The relation between relative frequency and classical probability modelled in the empirical law of large numbers is in itself an issue to be mathematically analysed and described by rules and models. In the history of probability theory, Bernoulli’s theorem provides an initial precise formulation for this mathematical relation (cf. Loève 1978). Within this elementary theorem of probability, a particular epistemological requirement concerning theoretical mathematical knowledge becomes apparent.

The reflexive statement in Bernoulli’s theorem saying that there is a very great probability that relative frequency and probability of the (ideal) chance experiment will come as close to each other as desired if the number of trials increases, is an expression of the circularity of the concept’s definition and of the complementarity of empirical, experimental situations and (ideal) mathematical modelling.

Bernoulli’s theorem required the abandonment of a supposedly deductive point of view in the development of knowledge and theory: what probability is can only be explained by means of randomness, and what randomness is can only be modelled by means of probability. This is where one accedes to those problems in the theoretical foundations of mathematics which, in a modern perspective, have become known as the circularity of mathematical concept definitions (in particular for the elementary concepts of probability, cf. Borel, 1965). This circularity or self-reference implies that knowledge must be interpreted, at all stages of its development, as a complex structure which cannot be extended in a linear or deductive way, but rather requires a continuous, qualitative change in all the concepts of the theory.

Thus, the foundations of mathematical knowledge are not determined once and for all; when developing mathematical theory further, ultimately the foundations are modified as well. In the history of mathematics, this process of transformation has always played a role: The change of the foundations of any

mathematical theory has at the same time changed the epistemological status of knowledge of these foundations.

Summary: 1. Mathematical knowledge as the subject of the discipline and as a subject in school requires different interactive ways of approaching it. Researching mathematicians use a professional discourse based on the body of rules of modern proof in order to reach understanding about mathematical objects, which are defined by conditions and postulates. Learning students understand and communicate about mathematics with generally understandable and illustration-bound conceptions about ‘a priori existing’ mathematical objects.

2. Mathematical knowledge cannot be imparted to students as a finished product, but an insightful understanding requires the students to carry out their own learning activities with respect to the features of the particular culture of mathematics learning and teaching.

3. The extension of mathematical knowledge – and particularly learning mathematics in school – is not simply an increasing quantitative accumulation of further mathematical facts, but it is a process of integration and generalisation of knowledge as well as of epistemological new interpretations of the foundations of mathematical knowledge.

References

- [1] Bauersfeld, H. (1982). Analysen zur Kommunikation im Mathematikunterricht. In H. Bauersfeld, H. W. Heymann, G. Krummheuer, J. H. Lorenz & V. Reiss (Eds.), *Analysen zum Unterrichtshandeln* (pp. 1–40). Köln: Aulis.
- [2] Bauersfeld, H. (1988). Interaction, Construction and Knowledge: Alternative Perspectives for Mathematics Education. In D. A. Grouws, T. J. Cooney & D. Jones (Eds.), *Effective Mathematics Teaching* (pp. 27–46). Reston, Virginia: NCTM & Lawrence Erlbaum.
- [3] Bekemeier, B. (1987). *Martin Ohm (1792–1872). Universitäts- und Schulmathematik in der neuhumanistischen Bildungsreform*. Göttingen: Vandenhoeck & Ruprecht.
- [4] Benacerraf, P. (1984). What numbers could not be. In P. Benacerraf & H. Putnam (Eds.), *Philosophy of mathematics*, (second ed., pp. 272–294). Cambridge USA: Cambridge University Press.
- [5] Bishop, A. J. (1988). *Mathematical Enculturation. A Cultural Perspective on Mathematics Education*. Dordrecht: Kluwer Academic Publishers. Borel, E. (1965). *Elements of the theory of probability*. New Jersey: Englewood.
- [6] Cobb, P. (1994). Where is the Mind? Constructivist and Sociocultural Perspectives on Mathematical Development. *Educational Researcher*, 23(7), 13–20.
- [7] Devlin, K. (1997). *Mathematics: The Science of Patterns—The Search for Order in Life, Mind, and the Universe*, W. H. Freeman, ‘Scientific American Library’ series.

- [8] Freudenthal, H. (1973). *Mathematics as an Educational Task*. Dordrecht: D. Reidel Publishing Company.
- [9] Fischer, Roland (2001). Höhere Allgemeinbildung. In: Fischer-Buck, Anne u. a. (Eds.): *Situation-Ursprung der Bildung*, (pp. 151–161). Franz-Fischer-Jahrbuch für Philosophie und Pädagogik 6. Leipzig: Universitätsverlag.
- [10] Hacking, I. (1975). *The emergence of probability*. Cambridge: Cambridge University Press.
- [11] Heintz, B. (2000). *Die Innenwelt der Mathematik*. Zur Kultur und Praxis einer beweisenden Disziplin. Wien New York: Springer.
- [12] Jahnke, H. N. (1990). J.F.Herbart (1776–1841): Nach-Kantische Philosophie und Theoretisierung der Mathematik. In G. König (Ed.), *Konzepte des mathematisch Unendlichen im 19. Jahrhundert* (pp. 165–188). Göttingen: Vandenhoeck & Ruprecht.
- [13] Loève, M. (1978). 'Calcul des probabilités'. *Abgrégé d'histoire des mathématiques 1700–1900. J. Dieudonné*. (II: 277–313). Paris: Hermann.
- [14] Maistrov, L. E. (1974). *Probability Theory: A Historical Sketch*. New York, Academic press.
- [15] Steinbring, H. (1980). *Zur Entwicklung des Wahrscheinlichkeitsbegriffs – Das Anwendungsproblem in der Wahrscheinlichkeitstheorie aus didaktischer Sicht*. Bielefeld: Materialien und Studien Bd. 18 des IDM Bielefeld.
- [16] Steinbring, H. (2009). *The Construction of New Mathematical Knowledge in Classroom Classroom Interaction – An Epistemological Perspective*. Springer: Berlin.
- [17] Voigt, J. (1994). Negotiation of Mathematical Meaning and Learning Mathematics. *Educational Studies in Mathematics* (26), 275–298.
- [18] Voigt, J. (1998). The Culture of the Mathematics Classroom: Negotiating the Mathematical Meaning of Empirical Phenomena. In F. Seeger, J.Voigt & U. Waschescio (Eds.), *The Culture of the Mathematics Classroom* (pp. 191–220). Cambridge, UK: Cambridge University Press.
- [19] Wilder, R. L. (1981). *Mathematics as a Cultural System*. London: Pergamon Press.
- [20] Wilder, R. L. (1986). The Cultural Basis of Mathematics. In T. Tymoczko (Ed.), *New Directions in the Philosophy of Mathematics* (pp. 185–199). Boston: Birkhäuser.
- [21] Wille, R. (2002). Kommunikative Rationalität und Mathematik. In Prediger, Susanne/Siebel, Franziska/Lengnink, Katja (Eds.), *Mathematik und Kommunikation*, (pp. 181–195). Darmstädter Texte zur Allgemeinen Wissenschaft 3. Mühlthal: Verlag Allgemeine Wissenschaft.
- [22] Wittmann, Erich Ch. (2003). Was ist Mathematik und welche Bedeutung hat das wohlverstandene Fach auch für den Mathematikunterricht der Grundschule? In Baum, Monika/Wielpütz, Hans (Eds.): *Mathematik in der Grundschule. Ein Arbeitsbuch*. (pp. 18–46). Seelze: Kallmeyer.

Symbolic Power and Mathematics

Ole Skovsmose*

Abstract

Symbolic power will be discussed with reference to mathematics. Two distinctions are pointed out as crucial for exercising such power: one between appearance and reality, and one between sense and reference. These distinctions include a nomination of what to consider primary and what to consider secondary. They establish the grammatical format of a mechanical and formal world view. Through an imposition of such world views symbolic power is exercised through mathematics.

This power is further investigated through different dimensions of mathematics in action: (1) Technological imagination which refers to the possibility of formulating technical possibilities. (2) Hypothetical reasoning which addresses consequences of not-yet realised technological initiatives. (3) Legitimation or justification which refers to possible validations of technological actions. (4) Realisation which signifies that mathematics itself comes to constitute part of reality. And (5) dissolution of responsibility, which may occur when issues of responsibility are eliminated from the discourse about technological initiatives and their implications. Finally, it is emphasised that whatever form symbolic power may take, it cannot be addressed along a single good-evil axis.

Mathematics Subject Classification (2010). 00A30

Keywords. Symbolic power, Mathematics in action, Technological imagination, Hypothetical reasoning, Legitimation, Justification, Realisation, Dissolution of responsibility.

*Ole Skovsmose, Department of Learning and Philosophy, Aalborg University, Fibigerstrade 10, DK-9220 Aalborg East, Denmark. E-mail: osk@learning.aau.dk

1. Symbolic Power

Symbolic power is not a well-defined notion, yet it has been used in many contexts¹. Symbolic power can be exercised through discourses which impose a range of priorities and implicit notions on that which is being addressed².

Symbolic power can be exercised by way of labelling, for instance by singling out particular groups of people. One can refer to immigrants when trying to shed light on street violence; blacks when addressing poverty in Africa; slow learners when trying to explain certain educational problems. In fact there is a close correlation between designating and an imposition of stereotypes. A language can operate as an instrument of simplification; one may think of the language developed around production efficiency. Such a language may refer to workers, but stripped of their human relationships, instead highlighting them as more or less efficient elements of a production machinery. Symbolic power can be exercised through concepts like “soul”, “God”, “salvation” just to mention some designations that includes layers of metaphysical assumptions. The discussion of symbolic power can refer to any form of discourse and to any form of language.

Rudolf Carnap found that one could get rid of all the misunderstandings and preconceptions that have been instilled in natural language by constructing formal languages³. In this way science would have a true universal formal format. Thus Carnap envisioned formal languages as liberators from the illegitimate power exercised by natural language.

2. Mathematics and Symbolic Power

A formal language is also a language, and as such it may exercise symbolic power. One can discuss, then, to what extent the symbolic power connected to formal languages is benevolent, or if it might be questionable, illegitimate, and suspicious. In fact a formal language might not be a liberator as assumed by Carnap. It might be the bearer of a power that is in need of being both identified and criticize; it might bring along with it heavy loads of metaphysical assumptions. In fact, it is possible for symbolic power to have the same huge range of qualities that can be associated to power in general.⁴ It could be problematic, unfair, blind, helpful, ruthless, benevolent, etc.

I do not assume that the notion of mathematics can be captured in any single definition. Instead I find that mathematics can take many different forms,

¹See, for instance, Bourdieu (1991). For a discussion of knowledge and power, see Foucault (1989, 1994, 2000).

²Several philosophers, from Nietzsche (1998) via Carnap (1959) to iek (2008) has formulated a heavy critique of the power exercised by language.

³See Carnap (1937).

⁴I use the notion of “quality” in a classic philosophical way as referring to “property”, and not to some degree of desirability.

such as making a budget, calculating a salary, making an investment, reading a map, completing a design, solving school mathematics exercises, solving an engineering problem, not to forget doing mathematical research. One can see mathematics as a language, as a discourse. In fact one can see it as an extended family of discourses that involve different degrees of formalism.

I will discuss symbolic power with reference to this extended family of languages in two steps: (1) One can see mathematics as a descriptive tool. However, there are no neutral descriptions. Any description includes priorities with respect to what to include and what to exclude. Also mathematics-based descriptions exercise symbolic power by nominating what to call primary and what to call secondary. (2) One can see mathematics as making part of actions, and I will explore this dimension of symbolic power by addressing different features of mathematics in action. Together the discussion of (1) and (2) will illustrate how I associate symbolic power to mathematics.⁵

3. What Is Primary and what Is Secondary?

We can imagine that symbolic power can be exercised through the invention of something that is not already the case. It appears that by applying mathematics one can invent measures, norms, and standards that were not really there before the mathematical discourse nominated the entities to be addressed. One can also assume that symbolic power manifests as the systematic overlooking of particular groups of phenomena. Thus, we can search for symbolic power by examining priorities for both “seeing” and “overlooking”. Such priorities can be imprinted in the grammar (or the structure) of language, and also of formal languages. Symbolic structuring provides a way of nominating something as primary and other things as secondary. Such a grammar-based primary-secondary ranking makes up one layer of a language-instilled metaphysics.

In order to clarify further the primary-secondary ranking, I will consider two distinctions that can be associated with mathematics. One distinction is related to the formulation of the mechanical world view, while the other is related to the formulation of what I refer to as the formal world view.⁶ By paying attention to these two distinctions, I try to point out two features of symbolic power that can be associated to mathematics.

3.1. Appearance and reality. Through the scientific revolution an intimate relationship between mathematics and the natural sciences was

⁵This applies to all different forms of mathematics, and also to the different forms of ethnomathematics. In the following, however, I will concentrate on what can be referred to as academic mathematics, in particular as it is realised through its applications.

⁶For a discussion of these two distinctions see Skovsmose (2009). See also Skovsmose (2005) for a discussion of mathematics and power. My work with these distinctions is inspired by my cooperation with Ole Ravn, see Skovsmose and Ravn (draft).

established. This relationship, however, was only made possible through the distinction between appearance and reality. The establishment of the heliocentric world view illustrates clearly what this distinction is about. Looking at the sun in the morning, one sees how it rises in the sky. During the course of the day one can follow its movements. In the evening we can see the beautiful colours of the western sky, when it sinks below the horizon. Literature is awash with variations of sunrise-sunset descriptions. Let us imagine that we were to collect all these descriptions and from them try to extract an insight into the sunrise-sunset phenomenon. According to the scientific revolution, we would never attain any insight at all, as we would remain trapped by the appearance of the phenomenon. At the heart of the formulation of the heliocentric world view is the assumption that one needs to get around the appearances of phenomena in order to grasp the structures of reality.

The distinction between appearance and reality has been emphasised by many. However, I will refer to a particular text by Galileo Galilei as paradigmatic for formulating the appearance-reality distinction. In *The Assayer*, first published in 1623, Galilei discusses the notion of heat.⁷ We all have experiences of this phenomenon. One may be burned by the rays of the sun, touch a warm kettle, come too close to a fire, gulp a spoonful of too hot soup, etc. One could try to register a broad variety of experiences with heat and on this basis try to formulate an insight as to what heat really is. Galilei's point is that such an approach brings us nowhere: our experiences of heat do not reveal anything about the real nature of heat. The "mechanics" of heat, according to Galilei, is very different from whatever might be gleaned from our sense experiences, just as the mechanism of sunrise and sunset is different from our experiences of these phenomena. According to Galilei, to provoke an experience of heat "nothing is required in external bodies except shapes, numbers, and slow or rapid movements" (Galilei 1957: 276–277).

The mechanical world view presents reality as a tremendous mechanism composed of material units, characterised by their shape, number and movements, governed by certain laws. Such a mechanism is behind experienced phenomena like heat as well as sunsets. It is behind any of our experiences. The appearance-reality distinction facilitates the formulation of the mechanical world-view and brings mathematics into a prominent position: it becomes the principal tool for describing reality. While natural language is useful for expressing experiences, mathematics is capable of depicting the underlying reality. It does so in terms of shapes, numbers and movements in other words: in terms of a mechanism.

If we assume that reality is *in fact* a mechanical structure, then mathematics can be assigned a tremendous descriptive power: it turns out to be not only necessary but also sufficient for grasping reality. If we think of this descriptive

⁷The *Assayer* is reprinted in Galilei (1957: 229–280). See also Skovsmose (2009) for a discussion of *The Assayer*.

power as a form of symbolic power, the whole outlook of the scientific revolution would bring us to celebrate the symbolic power of mathematics. This celebration has brought about the claim that mathematics is the language of sciences; it is the universal symbolism of knowledge. However, if we do not consider the mechanical world as a given to be discovered, but rather as invented, then we reach quite a different interpretation of this symbolic power. The mechanical reality is not described by means of mathematics but rather established through mathematics as a projection of the grammar of mathematics, which seems designated to talk about entities like shape, number, movements, etc. The mechanical world view is due to the way mathematics nominates certain phenomena as primary and ignores others as secondary. The mechanical world view can be seen as a frightening metaphysics rooted in the grammar of mathematics. Thus the mechanical world view becomes a demonstration of a symbolic power associated with mathematics. Through applications of mathematics the mechanical world view becomes imposed not only on nature, but on any domain that is mathematised: business, management, forms of production, marketing, etc.

3.2. Sense and reference. While in *The Assayer*, Galilei formulated a distinction between appearance and reality, Gottlob Frege, in *Über Sinn und Bedeutung*, first published in 1892, formulated a distinction between sense (*Sinn*) and reference (*Bedeutung*).⁸ The distinction between appearance and reality is linked to the scientific revolution, while the distinction between sense and reference can be linked to a formal revolution. Both distinctions specify what is to be considered primary and what secondary. While the distinction between appearance and reality concerns our perception of nature and physical environment, the distinction between sense and reference concerns our perception of logic and rationality. Frege sought to grasp the nature of logical reasoning.

To illustrate the distinction between sense and reference we can look at the notion of a triangle. In order to indicate the sense of the word triangle, one could try to explain that we are dealing with a geometric figure composed of three straight lines. If, however, one were to indicate the reference of the concept “triangle”, one would look to the set of all triangles. As Frege was a Platonist, he would see the reference as the collection of ideal objects. More generally, the reference of a concept is the set of objects that “fall under” that concept.

Frege also applies the distinction between sense and reference to statements. If we state that “the sum of the angles in a triangle is 180°”, then one could try to clarify the sense of that sentence, maybe by showing some of the steps in the proof of the statement. The sense of the statement has to do with the content of what is stated. However, according to Frege, the reference of the statement

⁸ *Über Sinn und Bedeutung* is reprinted in Frege (1969: 40-65). See also Skovsmose (2009) for a discussion of *Über Sinn und Bedeutung*.

is something quite different. He suggests that the reference of a statement is its truth value. Furthermore, he assumes that there are only two such values: “true” (or T) and “false” (or F). This means that the reference of the statement “the sum of the angles in a triangle is 180° ” is “true”. If we were to consider all possible statements, they would have lots of different senses, but their references would be either “true” or “false”. The domain of references of sentences would be a very small universe, namely consisting of only two objects, the two possible truth values, “true” and “false”.

Such a claim may appear absurd. However, it makes it possible for Frege to formulate his main point: in order to clarify the reality of logical reasoning, one needs to concentrate on the domain of references of concepts and statements. References can be considered primary, while senses are secondary and can be ignored. In fact, when it comes to logical investigation, the dimension of sense only confuses analysis.⁹

The distinction between sense and reference has also been expressed in terms of intension and extension, corresponding to sense and reference. Thus, the extension of a concept is the set of objects that fall under the concept, while the intension can be understood as its sense. The extension of a statement is its truth value, while its intension refers to the content of what is stated. With this terminology Frege’s claim is that the logical aspects of language are located in the domain of extensions, while the intentional aspects are carriers of psychological aspects. If one wants to grasp the reality of logical reasoning, one has to focus on the extensional aspects of language.¹⁰ If one pays attention to the intentional aspects, one might get bewildered by the appearance of rationality. This appearance may reveal just as little about logic as the experience of heat reveals about movements of molecules, or as the beauty of sunrise and sunset reveals about the rotation of the Earth.¹¹

Frege’s apparently absurd idea paved the way for a tremendous development of formal systems, formalisations of deduction, automation of reasoning and for the proliferation of formal languages, including all variations of computer languages. Frege’s ranking of primary and secondary with respect to logical reasoning is crucial for the development of artificial intelligence. It is crucial for establishing any automatic manipulation of formal systems.

⁹According to Frege, many have suffered such confusion. Mill, for instance, who found that in order to understand both the nature of logical reasoning and the foundation of mathematics, one had to grasp their inductive origin. See Mill’s presentation in *A System of Logic* and Frege’s harsh critique of Mill in *The Foundation of Arithmetic*.

¹⁰Frege’s idea was nicely condensed by Wittgenstein in the *Tractatus*, where he presented a truth-table logic.

¹¹An important step towards giving logic an extensional format was presented by Frege in his *Begriffsschrift*, which was published in 1879. Later Frege provided a new careful elaboration of formal logic in *Grundgesetze der Arithmetik*, which appeared in two volumes in 1893 and 1903. Many studies have followed, and Whitehead’s and Russell’s *Principia Mathematica*, published in three volumes in 1910-1913, reworked many of Frege’s ideas and established a more powerful symbolism than the one originally suggested by Frege.

However, one need not assume that the distinction between sense and reference reveals a basic reality of logical rationality. One may instead consider the possibility that the sense-reference distinction is imposed on the domain of investigation. It might be a proposal for implementing a primary-secondary ranking within the domain of logic. The ranking may represent a profound metaphysics with respect to rationality. Maybe a new logic is not discovered through the sense-reference distinction, so much as a new logic is created and brought into action. We might be dealing with an imposition that represents symbolic power. And this symbolic power is exercised with respect to all the different domains within business, management, forms of production, marketing, etc.— taken into custody by automatic manipulations for formal systems.

4. Mathematics in Action

Symbolic power connected to mathematics reaches beyond any primary-secondary imposition. It is manifested in mathematics-based actions. In this section I will illustrate the range of mathematics-based actions within technology. I use “technology” as an almost all-embracing concept referring to any form of design and construction (of machines, artefacts, tools, robots, automatic processes, networks, etc.) decision-making (concerning management, promotion, economy, etc.), and organisation (with respect to production, surveillance, communication, money-processing, etc.).

Like any action, so also a mathematics-based action can be described in general terms, and I will point out some of its dimensions: (1) Any action includes visions about what could be done, and by *technological imagination* I refer to the tentative formulation of technological possibilities. (2) As part of investigating a possible action, *hypothetical reasoning* is important. Through such reasoning one addresses consequences of not-yet-realised technological constructions and initiatives. Through an if-then reasoning one tries to estimate how feasible it might be to carry out an action. (3) An action may require *justification*. Some such justification may take place before one carries out the action, although one can also try to justify actions after their completion. In many ways, justification might take the form of a questionable *legitimisation*. (4) When completed, an action comes to make part of reality, and *realisation* of mathematics refers to the fact that mathematics itself may come to make part of reality. (5) One can think of an acting person as being responsible for the action. However, in many examples of mathematics-based actions, it is not easy to identify an acting subject, and a *dissolution of responsibility* might occur.¹²

¹²For presentations and discussions of mathematics in action see Skovsmose (2005, 2009); Skovsmose and Yasukawa (2009); Christensen and Skovsmose (2007); Christensen, Skovsmose and Yasukawa (2007); Skovsmose, Yasukawa and Ravn (draft); and Skovsmose and Ravn (draft). The following presentation of mathematics in action draws on this material.

4.1. Technological imagination. Often technological imagination is mathematics - based. As a paradigmatic example, one can think of the conceptualisation of the computer. The mathematical construct, in terms of the Turing machine was investigated in every detail.¹³ Even the computational limits of the computer were worked out before the construction of the first computer had taken place. If we consider the computational approach in all its dimensions, we can talk about the formal revolution, and this revolution is directly related to the sense-reference distinction. Algorithmic procedures which could be handled mechanically were related to the extensional aspect of language.¹⁴

All features of modern information and communication technology are deeply rooted in mathematics-based imagination. To illustrate: great potential for cryptography was identified through mathematical clarifications of number-theoretical properties. Of particular importance was the identification of what could be referred as a one-way function. This is a function, f , where it is easy to calculate $y = f(x)$, when x is given, but impossible in any feasible way to calculate $f^{-1}(y)$, when only f and y are given.¹⁵ The straightforward calculation of y from the value of x can be associated with encryption, and breaking the code, i.e. calculating x from the value of y , remains impossible.¹⁶ In this way a mathematical construct, a one-way function, provided new technological possibilities. There is no commonsense-based imagination equivalent to mathematics-based imagination. Furthermore, it must be noted that mathematics-based imagination operates beyond any scheme of prediction; instead it brings about contingencies as a characteristic feature of technological development.

Mathematics-based technological imagination plays a crucial role in economy and business, for instance in establishing schemes for prices and payment of goods. We can take air-fares as an example: airlines deliberately overbook as one element of such schemes.¹⁷ The overbooking is carefully planned; in particular, the degree to which a flight can be overbooked needs to be estimated from the statistics of the numbers of no-shows for the departures in question.

¹³See, Turing (1965) as well as Skovsmose (2009) for a discussion for this example.

¹⁴It is worth noting that intensional logic has developed tremendously, for instance through the work of Montague (1974), who was keen to develop a Frege semantics, acknowledging Frege's contribution to logic and the analysis of language. Montague demonstrated how apparently intentional features of language could be incorporated in a Frege semantics and, in this way, provided with an extensional foundation. This insight is crucial for developing computational linguistic features, and, for instance, for establishing automatic forms of translation.

¹⁵That it is possible to construct one-way functions is based on number theoretical insight, and in particular on the observation of the extreme complexity of factorising a product of two very large (say at least 50 digits) unknown prime numbers.

¹⁶See Skovsmose and Yasukawa (2009), as well as more general presentations in Schroeder (1997) and Stallings (1999). See also Diffie and Hellman (1976) for the presentation of the original idea.

¹⁷See Clements (1990). See also Skovsmose (2005) for a discussion of this example. There is a great amount of papers and comments about the phenomenon of overbooking at the internet. See for instance "Why do Airlines Overbook Flights" (<http://weakonomics.com/2009/12/29/why-do-airlines-overbook-flights/>).

(A “no-show” refers to a passenger with a valid ticket who does not show up for the departure.) The costs of bumping a passenger need to be estimated as well. (“Bumping” a passenger means not allowing a passenger with a valid ticket to board the plane.) The predictability of a passenger for a particular departure being a no-show is naturally an important parameter in designing the overbooking policy. The whole overbooking policy can be mathematically experimented with until a price-setting is reached that maximises profits, this in turn becoming an ongoing algorithmic-based process. Mathematics-based technological imagination is crucial, not only for the construction of new technological artefacts, but also for the identification of new schemes for, say, production, management, decision-making, etc. It is an imagination, however, that exists within a certain space. It is an imagination that assumes the mechanical world view, and it is an imagination that assumes rationality to be of a certain format.

4.2. Hypothetical reasoning. Hypothetical reasoning is counterfactual, as it is of the form: “if p then q , although p is not the case”. This form of if-then reasoning is essential to any kind of technological enterprise.

If we do p , what would be the consequence? It is important to address this question before in fact doing p . In order to carry out any more specific hypothetical reasoning within the domain of technology, mathematics is brought in action. A mathematical model comes to represent an imagined situation, and the model becomes the basis for identifying what could be the implications of doing what was imagined. However, the model-determined implications are just *calculated* implications. It is far from obvious what might be the relationship between such *calculated* implications and real-life consequences of completing the technological enterprise. The identification of implications, based on formal calculations, assumes that the mathematical model adequately represents what is to be implemented. But this assumption rests upon the mechanical world view claiming that the primary-secondary distinction imposed by the mathematical format of the model is adequate for identifying implications. In other words the assumption is that what the model downgrades as secondary is in fact secondary for identifying implications. However, this is a deeply metaphysical assumption. It is a questionable assumption that relevant implications are of a mechanical nature, and can be identified through formal calculations. Yet this assumption accompanies any mathematics-based hypothetical reasoning.¹⁸

4.3. Legitimation or justification. According to a classic perspective in philosophy, justification refers to a proper and genuine logical support of a statement, of a decision, or of an action, while the notion of legitimation does not include such an assumption. The point of providing a legitimation of an action might be to make it appear, *as if* it is justified. When a mathematical

¹⁸Risks emerge from the fact that mathematical modelling is, in this way, a technique for overlooking. The emergence of the risk society is partly due to the development of mathematics-based hypothetical reasoning than to mathematics-based actions in general.

model is brought into effect, it can serve as both a legitimation and a justification. It can help to provide priorities, although the basis for doing so might be obscure.

Let me try to illustrate this with a quotation from an article “The Predator War” by Jane Mayer in *The New Yorker*, which addresses US use of unmanned aircraft which can be used for identifying targets and for launching missiles. The Pentagon has created formulas to help the military develop a taxonomy of targets: “A top military expert, who declined to be named, spoke of the military’s system, saying, ‘There’s a whole taxonomy of targets.’ Some people are approved for killing on sight. For others, additional permission is needed. A target’s location enters the equation, too. If a school, hospital, or mosque is within the likely blast radius of a missile, that too is weighed by a computer algorithm before a lethal strike is authorized.”¹⁹

Although the particular details of such “elaborate formulas” for helping the military most likely will remain a military secret, we can speculate about the kind of rationality that is reflected in the taxonomy of targets. In principle, one could assume that an automatic connection between the processes of calculation and the military action has been established. However, according to the article one should assume that the decision—firing or not firing—is a human decision, although guided by the taxonomy.

We could imagine that the development of the taxonomy is of a cost-benefit format. On the benefit side must be counted the importance of the target, and the likelihood that the target will in fact be eliminated by the strike. But, most certainly, many other military gains could be considered. The costs of the action also have to be estimated, which implies a range of parameters to be considered. First one could think of the death of American soldiers, but as in this case we are dealing with unmanned aircraft this parameter might not enter into the cost-calculations. However, the value of the airplane must be included, although reduced by the rather small likelihood that the plane will get lost in the operation. The value of the missile fired will clearly represent a cost. But there are more parameters to consider: non-targeted people might be killed, and, as pointed out, the target could be located close to schools, hospitals or mosques. How does a school become “weighted” by a computer algorithm? Through the number of school children expected killed? Or through the economic value of such a child? Or perhaps it is not the school children as such that are valued, but the negative PR the bombing of school might cause?

The crucial point of cost-benefit analysis is that costs and benefits are measured by the same units. But which? What is the shared unit for cost and benefits, encompassing the value of fired missiles, American soldiers, school

¹⁹Brian Greer drew my attention to this quotation. See the whole article at: http://www.newyorker.com/reporting/2009/10/26/091026fa_fact_mayer?currentPage=all See also Greer (in print).

children, hospitals, mosques, etc.? One might label the stipulation of shared units of measurement for cynical equations. Such equations are necessary for any cost-benefit analysis and for turning a process of decision-making into a process of calculation. Cynical equations are made possible when a mechanical world-view is forced on the domain in question. All human matters are nominated “appearance”, while reality is constituted by what might be captured by mathematics. Originally, the appearance-reality distinction nominates the mechanical world view with respect to nature. However, when mathematics is applied to human enterprises, the appearance-reality distinction makes human matters secondary with respect to the enterprise in question. The “primary” takes a mechanical format captured by pre-designed scales of measurement—and cynical equations might come to appear both natural and neutral. Cynical equations stem from the imposed mechanical world view, and they enter smoothly into the automated procedures for formal manipulations. The formulation of cynical equations blurs the distinction between legitimisations and justifications. This not only applies to military action, but to any action—in engineering, economy, business, administration—where a mathematics-based taxonomy might provide a suspicious legitimisation with a glimmer of justification.

4.4. Realisation. A mathematical model can become part of our environment. Our life-world is formed through techniques and practices as well as through categories and discourses emerging from mathematics in action. Technology is not something “additional” which we can put aside, as if it were a simple tool, like a hammer. We live in a technologically structured environment, a techno-nature. Our life-world is situated in this techno-nature, and we cannot even imagine what it would mean to eliminate technology from our environment. Just try to do the subtraction piece by piece. We remove the computer, the credit card, the TV set, the phone. And we continue by removing medicine, newspapers, cars, bridges, streets, shoes. We have no idea about what kind of life-world such a continued subtraction would bring us. In this sense our life-world is submerged in techno-nature.²⁰

Mathematics is an integral part of both techno-nature and life-world. Thus computers, credit cards, TV sets, phones, medicine, newspapers, cars, bridges, streets, and shoes are today produced by means of processes packed with mathematics. But not only the objects which make part of our techno-nature are formatted through mathematics; so are many practices. Mathematics establishes routines: in production, in business, in all economic affairs, in daily life.

The whole domain of relevant knowledge for decision making at the stock market—buying or selling—is mathematised and made available through figures and diagrams. In this way mathematics can provide a highly relevant descriptive tool. One could also imagine that algorithms make proposals as to which decisions to make. However, there is a step more that can be taken. One might

²⁰For a discussion of the notion of life-world, see Skovsmose (2009).

imagine that the very decision about selling and buying is in fact made by a mathematical algorithm. The Danish newspaper, *Politiken*, in its edition of the 24th of February 2010 contains an article, “Maskinen overtager den globale børsandel” (“The machine takes over the global stock market”) by Jeremy Grant and Michael Mackenzie, whose point is exactly that the very decision-making is placed in the hands of algorithms. Furthermore the newspaper contains an article by Per Thiemann stating that 20% of the selling and buying at the Copenhagen Stock Market is conducted by the computer. This is an example of mathematics coming to be a direct part of the economic reality.

The overall implication of this is that the nature into which we are submerged is of a mechanical format. Techno-nature is a complex mathematics-based construction. Through mathematics in action, we are in fact bringing our social, political, and economic environment deeper into a mechanical format.

5. Dissolution of Responsibility

An action may be associated with an acting subject, this being a person or institution that conducts the action. Generally, the acting subject is held responsible for the action. This responsibility, however, can be questioned if the acting subject might have been forced to perform the action, or if they had been unaware of the full range of implications of the action.

However, mathematics-based actions often appear to be missing an acting subject. As a consequence, mathematics-based actions easily appear to be conducted in an ethical vacuum. As an illustration, one could think of automatic selling-buying decisions made at the stock market, as referred to previously. Such decisions are merged into automated clusters of decisions, and large quantities of such clusters have implications far beyond what is normally expected. It is in fact possible to relate features of the world-wide economic crisis to such mathematics-based avalanches of decisions. But who could be held responsible? Somehow responsibility seems to dissolve.

An example of such a possible dissolution of responsibility is presented by Mario Sanchez (2009, 2010) in his discussion of a “marginalisation index”. This index has been applied in a Mexican context in trying to invent measures for the degree of marginalisation which certain communities might suffer. Naturally, there can be many different ways of measuring marginalisation, but whatever modelling is applied, some parameters have to be introduced and related, and some standards have to be introduced so that the entire social, political and economic processes of marginalisation emerge in a modelled format. Here may occur an extreme form of primary-secondary ranking, where the experienced characteristics of marginalisation are “abstracted away”, in favour of only concentrating on quantitative and “mechanical” features of marginalisation. On this basis political action might be taken, or not taken. Such an approach has many implications, one of which might be that new criteria are formulated and claimed to be “objective”.

It might be claimed that mathematics helps to establish objectivity in calculations and that mathematics-based actions are well-considered and represent the optimal course to be taken. However, mathematics might also introduce a certain amount of arbitrariness into the decision-making process, as can be illustrated by the “cynical equations”. Arbitrariness might be covered by an overwhelming mass of formal calculations and formalities that may endow the result with a perceived necessity, although a subjective and impart necessity. This impartation draws on the whole metaphysics that accompanies mathematics. It does so by imposing a mechanical world view. This also applies to the mathematical marginalisation model. Through the impartation of necessity, elimination of responsibility becomes part of mathematics in action.

6. Symbolic Power, Beyond Good and Evil?

The duality between good and evil is deep-rooted in many philosophical discourses. But when we consider the symbolic power associated with mathematics, it might be relevant to try to step outside the good-evil duality. Symbolic power opens a space for technological enterprises that can be problematic, unfair, blind, helpful, ruthless, benevolent, productive, risky, innovative, etc. Such qualities cannot be described along a good-evil axis.

It could well be that mathematics imposes much on the domain it is assumed to describe. Mathematics can impose priorities concerning what is primary and what to relegate as secondary. Mathematics can become part of action by forming conceptions about what can be constructed, designed and accomplished. It can structure the as-if reasoning through which the viability of an action is addressed. It can provide patterns for justification and legitimation. It can come to make part of reality as an integral part of what has been implemented. Finally, mathematics in action might miss an “acting subject” and let responsibility dissolve. However, we cannot assume that we are in a position to provide any straightforward evaluation of such features of symbolic power.

My conclusion is not to try to eliminate or to obstruct the symbolic power that might be rooted in mathematics. Thus there is no point in claiming that the distinctions between appearance and reality and between sense and reference are “bad” distinctions, nor can they be claimed to be “good”. They are distinctions that may facilitate powerful symbolic actions. My point is to address this power explicitly, and to try to identify its possible dimensions.

Acknowledgements

This paper represents a combination and reworking of two papers “Mathematics: A Critical Rationality?” and “Symbolic Power, Mathematics and Formal Languages”. The two papers have not previously been published; however the first is submitted to the journal *Philosophy of Mathematics Education*, while

the second will serve as a basis for my participation in the conference *Mathematics Education and Contemporary Theory*, to be held in Manchester in July 2011.

Many of the ideas I have presented here are inspired by cooperation with others, and together with Keiko Yasukawa and Ole Ravn, I have explored many aspects of mathematics in action. I want to thank Mario Sánchez Aguila, Brian Greer and Miriam Godoy Penteado for many suggestions for improving the paper, and Kristina Brun Madsen for a careful proof-reading of the manuscript.

References

- [1] Bourdieu, P. (1991). *Language and Symbolic Power*. Edited by John Thompson. Cambridge (USA): Harvard University Press.
- [2] Carnap, R. (1937). *The Logical Syntax of Language*. London: Routledge and Kegan Paul. (Original German edition 1934.)
- [3] Carnap, R. (1959). The Elimination of Metaphysics Through Logical Analysis of Language. In A. Ayer (Ed.), *Logical Positivism* (60–81). New York: The Free Press. (Original German edition 1932.)
- [4] Christensen, O. R. and Skovsmose, O. (2007). Mathematics as Measure. *Revista Brasileira História de Matemática*. Especial No. 1 *Festschrift Ubiratan D'Ambrosio* (143–156).
- [5] Christensen, O. R., Skovsmose, O. and Yasukawa, K. (2009). The Mathematical State of the World: Explorations into the Characteristics of Mathematical Descriptions. In B. Sriraman and S. Goodchild, (Eds.), *Relatively and Philosophically Earnest: Festschrift in honor of Paul Ernest's 65th Birthday* (83–96). Charlotte, NC, USA: Information Age Publishing.
- [6] Clements, D. (1990). Why Airlines Sometimes Overbook Flights. In I. D. Huntley and D. J. G. James (Eds.). *Mathematical Modelling: A Source Book of Case Studies* (323–340). Oxford: Oxford University Press.
- [7] Diffie, W. and Hellman, M. E. (1976). New Direction in Cryptography. *IEEE Transactions on Information Theory*, 22, 644–654.
- [8] Foucault, M. (1989). *The Archaeology of Knowledge*. London: Routledge. (Original French edition 1969.)
- [9] Foucault, M. (1994). *The Order of Things: An Archaeology of the Human Sciences*. New York: Vintage Books. (Original French edition 1966.)
- [10] Foucault, M. (2000). *Power*. Edited by James D. Faubion; translated by Robert Hurley and others. New York: The New Press.
- [11] Frege, G. (1893, 1903). *Grundgesetze der Arithmetik I–II*, Jena: Verlag Hermann Pohle.
- [12] Frege, G. (1967). *Begriffsschrift, a formal language, modeled upon that of arithmetic, for pure thought*. In J. v. Heijenoort (Ed.), *From Frege to Gödel: A Source Book in Mathematical Logic, 1879–1931* (1–82). Cambridge (USA): Harvard University Press. (Original German edition 1879.)

-
- [13] Frege, G. (1969). *Funktion, Begriff, Bedeutung: Fünf logische Studien* (40-65). Göttingen: Vandenhoech & Ruprecht.
- [14] Frege, G. (1978). *The Foundations of Arithmetic/Die Grundlagen der Arithmetik*. German text with an English translation by J. L. Austin. Oxford: Blackwell. (Original German edition 1884.)
- [15] Galilei, G. (1957). *Discoveries and Opinions of Galileo*. Translated with an introduction and notes by Stillman Drake. New York: Anchor Books.
- [16] Grant, J. and Mackenzie, M. (2010). Makinen overtager den globale børshandel (The machines take over the global stock market). *Politiken*, Wednesday the 24th February 2010.
- [17] Greer, B. (in print). Discounting Iraqi Deaths: A Societal and Educational Disgrace. *ZDM The International Journal of Mathematics Education*.
- [18] Montague, R. (1974). *Formal Philosophy: Selected Papers of Richard Montague*. Edited with an introduction by Richmond H. Thomason. New Haven and London: Yale University Press.
- [19] Nietzsche, F. (1998). *On the Genealogy of Morality: A Polemic. Translated, with Notes*, by Maudemarie Clark and Alan J. Swensen. Introduction by Maudemarie Clark. Indianapolis: Hackett Publishing Company.
- [20] Sánchez, M. (2009). Uso crítico de los índices y modelos matemáticos gubernamentales en el desarrollo de profesores en servicio. *Educación Matemática*, 21(3), 163–172.
- [21] Sánchez, M. (2010). Gobierno y matemáticas. *La Jornada*. <http://bit.ly/9Kgrz>
- [22] Schroeder, M. R. (1997). *Number Theory in Science and Communication*. Third edition. Berlin: Springer.
- [23] Skovsmose, O. (2005). *Travelling Through Education: Uncertainty, Mathematics, Responsibility*. Rotterdam: Sense Publishers.
- [24] Skovsmose, O. (2009). *In Doubt: About Language, Mathematics, Knowledge and Life-world*. Rotterdam: Sense Publishers.
- [25] Skovsmose, O. and Ravn, O. (draft). *Matematikfilosofi*. Aalborg: Department of Education, Learning and Philosophy, Aalborg University.
- [26] Skovsmose, O and Yasukawa, K. (2009). Formatting Power of ‘Mathematics in a Package’: A Challenge for Social Theorising? In P. Ernest, B. Greer and B. Sriraman (Eds.), *Critical Issues in Mathematics Education* (255-281). Charlotte, NC, USA: Information Age Publishing.
- [27] Skovsmose, O., Yasukawa, K. and Ravn, O. (draft). Scripting the World in Mathematics: Ethical Implications? Aalborg: Department of Education, Learning and Philosophy, Aalborg University.
- [28] Stallings, W. (1999). *Cryptography and Network Security: Principles and Practice*. Upper Saddle River, New Jersey: Prentice Hall.
- [29] Thiemann, P. (2010). Maskiner handler danske aktier (The machines deals in Danish bonds). *Politiken*, Wednesday the 24th February 2010.
- [30] Turing, A. (1965). On Computable Numbers: With an Application to the Entscheidungsproblem. In M. Davis (Ed.), *The Undecidable* (115–154). Hewlett (USA): Raven Press. (First published 1936.)

- [31] Whitehead, A. N. and Russell, B. (1910–1913). *Principia Mathematica I–III*. Cambridge: Cambridge University Press.
- [32] Wittgenstein, L. (1992): *Tractatus Logico-Philosophicus*. German text with an English translation en regard by C. K. Ogden, Introduction by Bertrand Russell. London: Routledge. (First German edition 1921).
- [33] Žižek, S. (2008). *Violence*. New York: Picador.

Communicating Mathematics to Society at Large

Günter M. Ziegler

Abstract

What image does “the public” have of mathematics? Why and how should research mathematicians be involved in communicating mathematics and mathematical research to the public? Which “general audience” can we expect to reach (media, teenagers, highschool students, their parents and teachers, general public, learned public, etc.)? How do we reach them? What can we expect them to learn, to understand?

The panelists present and discuss their experiences in communicating with the public, both from the perspectives of mathematicians in academia, and from the perspectives of science journalists. They highlight the importance of the scientific message, the vocabulary of mathematics, the creative use of different formats to reach diverse audiences, and the wide range of mathematics the public can be stimulated to take an interest in.

The subsequent discussion will enlarge on these themes and, with comments from the audience, provide a basis for suggesting strategies for communicating effectively with society at large. The panel will conclude by discussing options and opportunities for international collaboration.

Mathematics Subject Classification (2010). 00-XX (General)

Keywords. Communicating Mathematics, Public Understanding of Science, scientific message, vocabulary, formats.

This is a short summary of the panel at ICM 2010 about “Communicating Mathematics to the Society at Large”. The panelists were:

- Marianne Freiberger
Plus Magazine, University of Cambridge, UK
M.Freiberger@damtp.cam.ac.uk
- Ivars Peterson
Mathematical Association of America (MAA), USA
ipeterson@maa.org
- R. Ramachandran
Frontline/The Hindu, India
bajji01@gmail.com

- Christiane Rousseau
Université de Montréal, Canada
rousseac@dms.umontreal.ca
- Günter M. Ziegler, *Chair*
Media Office, Deutsche Mathematiker-Vereinigung (DMV), Germany
ziegler@math.tu-berlin.de

There has been a lot of activities, progress, and achievements in the last decades' strong push of communicating mathematics to the public, which was initiated at various points of time in various countries (the US, Canada, the UK, Germany, for example), and even led to international activities. While some of these efforts have certainly been short-lived, others have been established on a more sustainable or even permanent basis.

Also in view of these initiatives and achievements, the ICM2010 panel set out to reconsider very basic questions: Which "general audience" can we expect to reach (media, kids, general public, learned public, etc.)? How do we reach them? What can we expect them to learn, to understand? Which image of mathematics do we communicate?

The activists on the panel will present and discuss their experiences, starting off with short presentations of five key aspects:

- (1) the importance of the message,
- (2) the vocabulary of mathematics,
- (3) the topics,
- (4) the setting, the occasions, and
- (5) an Indian perspective.

Each of these aspects is documented in the following by a short text by one of the panel members.

At ICM2010, the presentations on these topics were followed by a discussion that tried to collect ideas and recommendations. At the end, the panel discussed options and opportunities for international collaboration and joining forces throughout the world. The audience was invited to join this discussion.

Communicating Mathematics: The Message

Christiane Rousseau

Science in general, and mathematics in particular, is not well understood from the public. We hear too often:

“Hasn’t everything been found in mathematics?”

“What is mathematics useful for?”

Why should mathematicians be involved? We are certainly partly responsible for the public image of our science. Indeed, it is not without social consequences:

- The power of mathematical ideas and problem solving for scientific or technological breakthroughs is not sufficiently recognized. This results in insufficient funding and support for our discipline. But also, a better recognition of the importance of mathematics would help ensuring more jobs in industry for graduates in mathematical sciences.
- Mathematics could be better taught in the schools if a perspective of where we need to bring the students was more widely spread.
- In many countries we are faced with the fact that too few high school students choose to do mathematics and science.

The questions above deserve an answer. If the answer is given by a mathematician, then another message goes through: the mathematician is a human person. Similarly to a kid, he (she) repeatedly asks questions. Through his (her) deep understanding of the subject, the mathematician can instil the flavor of the discipline. The passion is important for the message to go through and, at the same time, the modesty to admit the limits of the scientist, and the many questions to which we can only answer “I don’t know.”

Not all mathematicians need be involved in popularization of mathematics. This requires a passion for communication, which we do not necessarily all share. On the other hand, improving our communication skills when involved in popularization activities helps improving the quality of our teaching: we introduce a distant horizon and place our subject inside a wider scope, we introduce links with other mathematical subjects and scientific disciplines, we show applications, we stick to crystal clear explanations, and we introduce strong messages through our teaching.

The importance of the message. In order for the message to go through, it should not be too technical. A dream when you do popularization of mathematics is that the listeners of your lectures or the readers of your papers can, in turn, explain part of it. For this, it helps if they have felt a skeleton around which the message is built. What is the spine? The central part could take

the form of a slogan or a leitmotiv. The leitmotiv should be sufficiently well illustrated that it is digested and remembered.

Let us give examples. Some are not from me, but they are so good that they deserve to last.

1. *Mathematics makes the invisible visible.*
2. *Mathematics provides models to the other sciences.*
3. *Mathematics makes predictions.*
4. *Mathematics classifies objects.*
5. *Mathematics is a living discipline within science and technology.*
6. *The importance of a clever idea for a scientist.*
7. *There is no limit to the imagination of a scientist.*
8. *The existence of unifying ideas inside mathematics or science.*
9. *Mathematicians introduce new concepts and generalize.*

When you read this enumeration, you certainly noticed that we missed some. . . So, it will be your turn to develop your favorite message.

Some guidelines to prepare the message. The danger for a scientist going into popularization is to be too technical and/or too long. If you are involved in popularization of mathematics, there is no need to choose a subject that is close to your research interests. Choose a subject that is both scientifically significant, and likely to bring a strong message.

It is important to address all people in the audience. The message should be adapted to the less learned, and one should never be intimidated, nor change the message, because there are mathematicians in the audience. At the same time, the message should be sufficiently scientifically sound that anyone in the audience, including the scientists, be interested.

The choice of words is important. Formal definitions, formulas, proofs should be avoided or kept to a minimum. Analogies with known concepts are important. Even, the choice of technical details (which should not be too numerous) should be done so as to convey a message: it could insist on the power of a clever idea, the elegance of a small piece of proof, etc.

This ends my short summary. A more detailed exposition appears in [1].

References

- [1] C. Rousseau: The role of mathematicians in popularization of mathematics, *Proceedings of the International Congress of Mathematicians*, vol I, p. 723–738, 2010.

Communicating Mathematics: The Vocabulary Problem

Ivars Peterson

Some years ago, at a conference that brought together mathematicians and science writers to discuss ways to inform the public more effectively about mathematics and discoveries in mathematics, a well-known mathematician presented a talk on exciting, new findings linking the Riemann Hypothesis, quantum physics, and random matrix models.

Though carefully prepared and relying on little more than basic calculus and linear algebra, the presentation missed its mark. A model of mathematical exposition, it would have worked well with an audience of mathematicians. It did not work for an audience of science writers. It contained too little of the grand ideas underlying the mathematics and too much of the mechanics of presenting these ideas mathematically. Indeed, by neglecting to define prime numbers or even dip into the lore and lure of primes, the speaker failed to connect with his audience from the beginning.

In the discussion that followed the presentation, one science writer likened the talk to the way she had felt at a party with some German friends. Her friends would try to speak English for a while but would inevitably lapse into German. She could understand very little of the ensuing conversation.

Speakers also tend to overestimate how much new information their audiences can absorb in one sitting. To reach the “new and exciting” part of his talk, the conference speaker had to describe the Prime Number Theorem, the Riemann zeta function, the Riemann Hypothesis, quantization and linear operator matrices (along with eigenvalues), random matrix theory and unitary symmetry, Poissonian statistics, and quantum chaos. That was a heavy burden for any audience, even more so for listeners not already attuned to these topics.

Authors of written material have an advantage over speakers. Readers who lose the thread of an argument can reread a difficult passage, return to earlier sections to recall a definition or key point, or even go to an outside source to obtain the necessary knowledge to proceed. Listeners typically can't do that. At the same time, however, authors cannot count on readers being willing to put in a lot of extra effort just to get to the end of an article. Many readers would (and do) give up.

Mathematical language itself throws up additional barriers to broad dissemination. The statements of mathematics are supposed to be precise, devoid of the ambiguities of ordinary speech. The meaning and position of every word and symbol make a difference. The language is unusually dense. And mathematical statements can be highly complex and may incorporate a specialized vocabulary.

Mathematician William Thurston expressed the difference between reading mathematics and reading other subject matter in this way:

“Mathematicians attach meaning to the exact phrasing of a sentence, much more than is conventional. The meanings of words are more precisely delimited. When I read articles or listen to speeches in the style of the humanities . . . I find I have great trouble concentrating and comprehending: I think I try to read more into the phrases and sentences than is meant to be there, because of habits developed in reading mathematics.” [1]

Such habits add to the difficulties that mathematicians face in trying to communicate with the public, when they have to surrender the clarity and economy of their usual modes of expression to the messiness of ordinary language. Comfortable with their specialized language, mathematicians too often fall into the trap of assuming their listeners or readers have equal facility, or at least some familiarity, with the language.

To complicate the situation, at least in the English language, mathematicians have appropriated simple, everyday words for their own purposes, using them in unexpected ways or assigning them specific, technical meanings to express abstract concepts.

Consider, for example, the term “function,” a notion fundamental to mathematics. *The American Heritage Dictionary of the English Language* offers the following definitions:

1. The action for which a person or thing is particularly fitted or employed.
2. a. Assigned duty of activity.
b. A specific occupation or role: in my function as chief editor.
3. An official ceremony or a formal social occasion.
4. Something closely related to another thing and dependent on it for existence, value, or significance. Growth is a function of nutrition.

The mathematical meaning comes next:

5. Mathematics
 - a. A variable so related to another that for each value assumed by one there is a value determined for the other.
 - b. A rule of correspondence between two sets such that there is a unique element in the second set assigned to each element of the first set.

It is followed by three more definitions:

6. *Biology* The physiological activity of an organ or body part.
7. *Chemistry* The characteristic behavior of a chemical compound, resulting from the presence of a specific functional group.
8. *Computer Science* A procedure within an application.

That's a hefty load for one word to carry. Readers or listeners encountering the word "function" may have difficulties sorting through so many definitions to ascertain the word's meaning in a particular context. Even when such a word is properly defined near the beginning and the context is clear, a reader unfamiliar with the notion may later revert to other, more familiar meanings of the word, potentially creating confusion in the reader's mind.

When I was a writer for *Science News* magazine, I could only on rare occasions get away with using the word "function" in my mathematics news articles without offering some sort of definition of the concept, expressed in words. My editors were there to ensure that my articles were accessible to as broad a range of readers as possible, and this meant keeping in mind that a reader's notion of what a word means could differ enormously from the author's intended meaning.

In the same way, mathematicians should realize that words that they use routinely can echo in unexpected ways in the minds of their listeners or readers, particularly in ways that reflect different experiences and contexts. Such words include acute, base, chaos, chord, composite, concurrent, coordinate, degree, dimension, domain, exponent, factor, graph, group, linear, matrix, mean, network, obtuse, order, power, prism, proof, radical, range, relation, root, series, set, vector, and volume. Each has a precise mathematical meaning; each also has multiple alternative meanings.

On the other hand, the word "fractal," coined by mathematician Benoit Mandelbrot, is a noteworthy example of a term that works in both a mathematical and a popular context. Mathematics could use more such words.

People are genuinely curious about mathematics, despite the overwhelming fear of the subject that many may feel. Mathematicians who pay particular attention to how they express themselves and connect with their audiences through a common, nontechnical language can make important contributions to the public understanding of mathematics.

References

- [1] W. Thurston: Private communication.
- [2] T. Gowers, ed.: *The Princeton Companion to Mathematics*, Princeton University Press, 2008.
- [3] I. Peterson (1991), Searching for new mathematics, *SIAM Review* 13 (1991), 37–42.

Communicating Mathematics: The Topics

Marianne Freiberger and Rachel Thomas

Plus magazine (plus.maths.org), a free online magazine about all aspects of mathematics aimed at the general public, is an interesting case study of the public's appetite for mathematics. The success of the Plus website, which has been established since 1997, indicates that this appetite, contrary to popular belief, is considerable. In 2009 the website attracted nearly 1.6 million absolute unique visitors, with our readers ranging from older school students, to university students, teachers and academics, and the non-expert general public. (Source: Google Analytics).

The most important lesson we have learnt as editors of Plus is that there is an audience for all types of mathematics, be it pure or applied, easy or hard. Some people are drawn to the beauty of mathematical ideas or philosophical questions, others to practical applications, or hands-on problems, and others can be drawn in by “stealth” through revealing the mathematics that hides behind seemingly un-mathematical ideas. Even, or perhaps especially, the hardest mathematical concepts can find a large audience, as long as they are presented accessibly and in a non-patronising, engaging way.

We assess the popularity of our content in two ways. Firstly, by looking at our website statistics, including the number of page visits an article receives, time spent on a page, and whether visitors go on to view other Plus content subsequently. These statistics enable us to estimate how many readers actively engaged with the content. Secondly, we look at qualitative feedback through emails from readers, comments posted on our blog, and in particular discussions of our content on other websites. These include aggregation sites like reddit.com or digg.com, which allow users to recommend and discuss web content.

This information indicates which of our articles have proved particularly successful with a wide audience. From qualitative feedback we can assess why a particular article has been successful, and to a certain extent what kind of audience it appeals to.

To illustrate the variety of material that has been successful, we present three examples from the Plus archive. The first two of the following articles come in the all-time top 10% of our material measured through our website statistics analysis and have generated lively online debate. The third is a topical piece which was very popular at the time of publication.

Mysterious number 6174 by Yutaka Nishiyama

“I hate math but love this kind of stuff. So fascinating” — reader comment

The number 6174 is a fixed point of Kaprekar's operation, a simple operation taking the set of 4-digit whole numbers into itself. The article explores the operation, proves the uniqueness of the fixed point, and shows that it attracts

every sequence resulting from iteratively applying the operation to a generic four-digit number.

This article is the all-time favourite on Plus. The mathematics that's explored is extremely simple and the article gives readers the chance to actually do the maths: anyone can take a calculator, apply the operation to their favourite number, and see the sequence converge. And this is what makes this particular article appealing. Reader feedback has shown that its large audience contains many people who do not consider themselves interested in mathematics (see the quote above), but quickly become intrigued by the opportunity to explore these ideas themselves.

The article illustrates the appeal of easy and hands-on pieces of mathematics. When presented in a friendly way that appeals to people's playfulness, these can draw in audiences that would not normally engage with mathematics. It's important to note that easy doesn't necessarily mean trivial – the article ponders if the result hides a deeper theorem in number theory, thus giving people a glimpse of what motivates mathematicians and the kind of problem they might work on.

The story of the Gömböc by Marianne Freiberger [1]

“Absolutely fascinating how awesome human science is” — reader comment

A Gömböc is a 3D convex and homogeneous shape with exactly one stable and one unstable point of equilibrium. Analogous to the 2D case, such an object was conjectured impossible, until its existence was proved in 2006 by two Hungarian mathematicians. This article is based on an interview with one of these mathematicians, Gábor Domokos, exploring some of the maths and the process of discovering the proof.

Why should such a curious mathematical object, devoid of any practical applications, appeal to a popular audience? Reader feedback indicates that the reasons why it does are not that different from those that attract mathematicians: the object's sheer strangeness and the suggestion that it might not exist. In online discussions, readers have marveled at the Gömböc's strange self-righting wriggle (the article includes a video of an actual Gömböc self-righting), explored the meaning of its mathematical definition, and what makes it different from familiar objects, for example eggs.

Another point of appeal of the article, we believe, is the glimpse it affords of the human experience of doing mathematical research, with all the set-backs and triumphs involved in feeling your way towards a proof. Such journeys of discovery can appeal to a wide audience, even if the object of discovery is not something everyone would normally consider interesting.

Swimming in mathematics by Rachel Thomas

Published in the wake of the 2008 Beijing Olympics, this article explores the Games' swimming venue, known as the Water Cube, a beautiful structure

which appears to be made from bubbles. The article describes how architects used Denis Weaire and Robert Phelan's response to Kelvin's problem to come up with this organic-looking structure.

The appeal of the article is immediately clear: the Water Cube is a beautiful building people would have seen many times during the Games. The article also benefits from elements of surprise. Many people were not aware of the fact that mathematics was involved in the design of the apparently random-looking arrangement of bubbles that makes up the building's external structure. The underlying mathematical problem – the Kelvin problem – is relatively easy to state, yet it is still not known if the Weaire–Phelan structure is the most efficient solution.

There are more interesting examples. Other articles that have been particularly successful cover the Riemann hypothesis, Gödel's incompleteness theorem, the mathematics of music, and a range of perhaps surprising applications, such as a mathematical model of the neurological processes that cause visual hallucinations.

We are not claiming that each of these articles exerts the same appeal on the same audience (though they almost certainly overlap). Each article probably finds its own audience who enjoy a particular approach and with particular interests. But this merely reflects the many aspects of mathematics: some people are drawn to ideas, some to patterns and forms, some to mathematics as a universal language, and others to puzzles. In terms of popularization, the multifaceted nature of maths should really give it an edge over other fields, as it provides so many ways to engage a non-expert audience.

The quality of presentation is of course extremely important. If you don't stimulate your audience's imagination, you lose them immediately. This doesn't mean that difficult ideas can't be brought across, but it means that, akin to a conversation, you must address any questions as they might arise in people's minds, rather than requiring your audience to do the mental legwork. While the definition-theorem-proof structure of a research paper presents the reader with a *fait accompli*, a popular article may be better off reflecting what actually happens when you do the research: play around with examples, develop a feel for the mechanisms at work, pose a conjecture, and, if you can, prove it.

Research mathematicians have a vital role to play in the popularisation of mathematics, whether it is through producing material themselves, or interacting with science communication professionals. Our experience at Plus has shown that researchers' expertise and passion bring a richness to our content that would otherwise be hard to reproduce. Moreover, presenting the human face of mathematics, the people who produce it, is a vital tool in engaging people's interest. We believe that many mathematicians under-estimate this interest. As more working mathematicians engage with the public, more people will identify with mathematicians and their work, and the perceived gulf between the maths community and the public will start to diminish.

References

- [1] M. Freiberger, The story of the Gömböc, *Plus magazine* 52, September 2009, plus.maths.org/issue52/features/gomboc/.
- [2] Y. Nishiyama: Mysterious number 6174, *Plus magazine* 38, March 2006, plus.maths.org/issue38/features/nishiyama/.
- [3] R. Thomas: *Swimming in mathematics*, *Plus magazine* 12/9/2008, plus.maths.org/latestnews/sep-dec08/watercube/.

Communicating Mathematics: The Setting, the Occasions

Günter M. Ziegler and Thomas Vogt

“Communicating Mathematics to the Society at Large” does not mean that the public has to be invited to the University, where a Mathematics Professor explains mathematics at the blackboard. Indeed, it need not involve a university, nor a professor, nor a blackboard.

The German “Year of Mathematics” 2008 (which was part of the German series of National Science Years started in 2000 and was more visible and more successful than all the previous ones; see also [5] and **Z-mathyear-gazette**) was also a gigantic learning experience, a welcome experimental platform, and an opportunity for professionalization of mathematics communication in Germany. In the following, I comment on these three aspects.

Learning to Communicate. Very vividly I remember three insights from the discussions and planning meetings that preceded the Mathematics Year.

The first one was to go ahead with a positive, active message. I was warned “Wer sich verteidigt, ist ein Looser” (“Whoever defends himself is a loser”). So we should not complain about the negative image that our subject might have in the public and in the media, but rather go ahead with “Mathematics is an exciting subject, it has many stories to tell, it is full of interesting challenges, it is the basis for exciting jobs”, etc.

The second is that you really have to think about what you mean by “the public” or “society at large”. Who do you *want* to reach, who is your target group: the people who go to exhibitions, those who read the science pages in the daily newspapers, the readers of the “Arts and Letters” section of the same newspapers, pupils, students, teachers, parents? Hardly any format can reach all of them. And you also should think about *what* you want to communicate. My belief is that you can’t *teach* much Math to the Society at Large – the teaching has to be done in the schools. However, it is essential to work on the public perception of what Mathematics is about, about what Mathematicians do, about news and challenges, images and jobs. For the Mathematics Year,

after all these discussions we set a particular emphasis on reaching the schools. And we did this with a positive message: “Du kannst mehr Mathe, als Du denkst” (“You know more maths than you think”).

The third insight was a positive surprise: The media *are* interested. After a rather dull “Year of the Humanities” in Germany, which journalists and newspapers had taken no big interest in (most of the journalists have studied some humanities subjects), math as a difficult subject with a very love-and-hate public perception and a new, fresh message was interesting – and this gave us the opportunity to reach very diverse audiences.

Experimenting with Formats. There are many different media, channels and forms of presentation to try out: Lectures, quiz shows, books, blogs, newspaper features, posters, games, websites, events, exhibitions, etc. Here are five examples of surprisingly successful formats that we have experimented with – probably none of them can be copied as it is, but you could think of “your own version”.

1. On occasion of the Maths Year, the Mathematisches Forschungsinstitut Oberwolfach (under its director Gert-Martin Greuel, assisted by Andreas D. Matt) pioneered an exhibition called “IMAGINARY – with the eyes of mathematics” [4], which presented images of algebraic surfaces in large color pictures. It came along with software called “surfer” that you could download to create your own surfaces and images. This was taken up by *Spektrum* science magazine (the German edition of *Scientific American*) as well as by *zeit.de* (the online version of the weekly *Die Zeit*) who ran competitions for the most creative images. By December 2008, the exhibition had been shown in 13 German cities and had more than 120,000 visitors, including more than 340 school classes. The website for the exhibition had different 130,000 visitors, and more than 5 million hits. The software was downloaded more than 40,000 times, and the contests were great successes.

2. On various occasions I ran a “Maths Quiz live” – modelled after the TV-show “Wer wird Millionär” (the German version of “Who wants to be a millionaire?”). This is a very flexible format, which works for small, medium and large audiences. I would pose 12 problems (plus one warm-up problem to explain the rules, and three tie-breaker extra problems). For each problem I offer four answers, A, B, C, and D, *exactly one* of which is correct. You can have a few contestants on the stage, or have school classes compete against each other. All you need is a good collection of problems (suitable in difficulty for the audience you expect – my audiences ranged from middle-school kids to the German Minister of Science and a room full of science journalists).

Simple problems are of the type: How much does the area of a rectangular garden grow if you increase its length and its width by 10% each. (Answers: A: 10%; B: 20%; C: 21%; D: Can’t tell, depends on the shape of the garden.)

My favourite tie-breaker: What **** *, ** * * * * N , * * * * * * * * * * * * * * * ?

(Answers: A: $N > 30$; B: N is a square between 10 and 20; C: $N = 16$; D: $N = 42$.)

Note: This is not primarily a format where we would try to teach mathematics, but just to entertain — and to whet the appetite for problems . . .

3. In 2004, the DFG Research Center MATHEON “Mathematics for Key Technologies” in Berlin started to run an annual Digital Advent Calendar on the internet (modelled after the traditional advent calendars which would have a piece of chocolate behind doors, which are to be opened on the 24 days before Christmas), targeted at upper-level highschool students and adults: On each day of advent, December 1 to 24, there is a problem posted at 6pm, which has to be solved correctly within a certain time limit. In the end prizes are awarded to the pupils and to the adults who would achieve the largest number of correct answers – and needed the smallest extra time beyond the time limits. The problems would typically be rather hard, connected to research done at MATHEON. (Even the head of the German Science Foundation, MATHEON’s funding agency, has once admitted that he had looked at the problems and decided that they were too hard for him.) A collection of the problems is now available as a book [1]. At the end of the Math Year, the DMV Media Office also started to run a separate internet advent calendar, for younger pupils, classes 5–7. See [3] for the common web presence of the two advent calendars. Both calendars have developed into huge successes: In 2009, the calendar for the younger pupils had nearly 32,700 registered participants, while the MATHEON calendar had more than 16,300 participants from 48 countries — despite the fact that the problems are offered only in German.

4. Various mathematics exhibitions drew large crowds in the Mathematics Year. Perhaps the most unusual format for such an exhibition is the Science Ship, which, run by “Wissenschaft im Dialog” (“Science in dialogue” www.w-i-d.de), is a regular part of each of the German Science Years. The ship would travel on the Rhine and Elbe rivers, with stops at larger and smaller cities for one to four days, where school classes and individuals would visit. The ship holds an exhibition of some 600 square meters, compiled from contributions suggested and provided by various universities and research institutes. Students would be on the boat as “tour guides” who could offer explanations. The media response is amazing – the local media would have advance reports about “the ship will be in town”. The 2008 mathematics exhibition on the science ship had more than 110,000 visitors in 31 cities in less than four months.

5. The German Mathematical Society DMV awards its *Mathematics Journalists’ Prize* (for a specific piece about mathematics) as well as a *Media Prize* (for someone’s “collected works”) every second year. On occasion of the Mathematics Year, DMV awarded an additional *Mathematics Cartoon Prize*, funded by De Gruyter Publishers, and promoted by the cartoon website toonpool.com.

This contest was an unexpected, huge success, with 260 contributions by 158 cartoonists from 40 different countries. See [2] for the winning entries.

Humor is, I believe, a category that is underused in science communications in general. Think about this. (For me personally the cartoon contest provided the cover illustration for a book about Stories from Mathematics [7] — a drawing by a Mongolian artist, Tsogtbayar Samandari, that I would certainly not have been aware of without the contest.)

Building Professional Structures The “Mathematics Year 2008” was a joint enterprise of the German Federal Ministry of Science and Education (BMBF), the Deutsche Telekom Foundation (DTS), the “Science in Dialogue” agency, and the German Mathematical Society (DMV). It was *run* to a large extent by a large advertising agency without any specific mathematics expertise. Thus we had insisted to run a “Mathematics Content Back Office”, where Thomas Vogt, a trained science journalist together with a team of students, freelancers and volunteers would prepare contents, give advice, check that the math was right and the emphasis made sense on all publications of the Math Year.

This Math Contents Back Office later grew into what is now the “Mathematics Media Office” of DMV at TU Berlin, still headed by Thomas Vogt (under my direction), funded now by TU Berlin, as well as private/industry funding agencies such as GesamtMetall. In year two after the Math Year we are very successful in reaching the media, ran the second installment of M^3 , the “Math-Month May” that gives a common framework for a dozen different local mathematics events at different places in Germany, administrate the Abitur Prize (sponsored by Springer), prepare the next edition of Mathematics advent calendar, etc. The Media Office is our platform to answer journalists’ queries (quickly!), prepare press releases, prepare contents for the DMV website, and dozens of other things. (There is enough to do.)

It is a lot of work (and also needs money) to address the media and the public in a sustainable way. But the effort will pay off some day. Talking about mathematics is the first step towards doing mathematics. Positive experiences with mathematics at a young age will draw young people into mathematics studies some day. And decision makers, reading about mathematics in the daily papers, will become aware of mathematics as a part of our culture and also as a part of our daily life – and appreciate its importance for society and economy.

References

- [1] K. Biermann, M. Grötschel & B. Lutz-Westphal (Hrsg.): Besser als Mathe: Moderne angewandte Mathematik aus dem MATHEON zum Mitmachen, vieweg+teubner 2009.
- [2] Deutsche Mathematiker-Vereinigung: Mathematics Cartoon Contest 2008, dmv.mathematik.de/component/content/article/515.html
- [3] DFG Research Center MATHEON & Deutsche Mathematiker-Vereinigung DMV: Mathematische Adventskalender, www.mathekalender.de

- [4] G.-M. Greuel, A. D. Matt: IMAGINARY – Mit den Augen der Mathematik, Mathematisches Forschungsinstitut Oberwolfach, www.imaginary2008.de
- [5] Jahr der Mathematik. Alles, was zählt, www.jahr-der-mathematik.de
- [6] G. M. Ziegler: Math matters: The German Year of Mathematics, *The Australian Mathematical Society Gazette*, 36(2):6–11, 2009, www.austms.org.au/Publ/Gazette/2009/Mar09/MathsMatters.pdf.
- [7] G. M. Ziegler: Darf ich Zahlen? Geschichten aus der Mathematik, Piper, München 2010.

PostScriptum: A Question from the Discussion in Hyderabad

The panel discussion at ICM Hyderabad on Wednesday, August 25, drew a very large crowd, and the panelists' presentations (based on the preceding pieces) led to a very interesting and diverse discussion. This cannot be recorded here in detail – but we want to present one interesting question asked in the course of the discussion. The question referred to a book review (on A. Aczel's "Fermat's Last Theorem"), which said that the book "successfully creates the illusion of understanding". The question to the panel was, whether this should be considered a good or a bad thing.

As panelists, we use the opportunity of this post-scriptum to share our personal views on this.

Christiane Rousseau: How do we learn, and what is understanding? We enrich our general knowledge by layers. Understanding could be described as putting a structure in our knowledge, for instance building it around a spine, bones, etc. The process is not necessarily linear. Indeed, knowledge and understanding often increase through a back and forth movement: we add thin layers to the knowledge. At the same time, we add more structure (understanding) through additional bones. With experience, we learn to put a structure in any new knowledge from the very beginning. As a professor, it is one of my goals that my students acquire this skill. How is this created? At each level of the process of learning, there should be an "illusion" of understanding. The next levels refine and enrich that understanding. How can we achieve that? At each level of learning, there should be a strong message which provides both a thin layer of knowledge, and some contribution to the structure. There is a price to pay for this: we need to use simplifications and/or analogies, and to avoid some details. So, to me, the communicator is allowed to "cheat" with details. Where do we pass from "illusion of understanding" to full understanding? There is no easy answer to this. We often realize that our full understanding was only partial... Hence, to me "illusion of understanding" is desirable, as long as we have the modesty to admit its limit...

Günter M. Ziegler: Science communication to "the society at large" does not necessarily mean that we can *teach* mathematics, such that *understanding*

would be the ultimate goal. Indeed, there are many occasions where teaching is impossible, unnecessary, or undesirable, but where we have the chance to *report* about mathematics, to tell stories (success stories, for example), to portray the field, the persons, to report about the setting and the impact of current research, etc. In this case, the main goal after a public lecture or event, or after people read your article or book would not be that they *understand more mathematics*, but rather that they *understand more about mathematics*. This is equally valuable, but in this domain “understanding”, the “illusion of understanding”, or the feeling that they “understand what it is about” may be plainly the same thing. And in many public or literary settings or occasions, this is also all you can hope for. A full “understanding the mathematics”, as we know, is often only achievable via years of serious study.

Marianne Freiberger: The question is what is meant by the “illusion of understanding”. Presenting mathematics to a general audience is akin to guiding people through a complex and unknown landscape. You need to provide people with a map and it’s your choice what kind of map is appropriate for the audience: what level of detail to include, which features of the landscape your map should faithfully preserve, and where you allow some distortion in order to make your map easy to read. In some sense any map creates illusory understanding: there’s much more to a landscape than a map tells you and often there’s been some distortion you may not be fully aware of. The important point is, however, that the map correctly reflects the aspects of the landscape that are of interest: it should not lead you astray, or lead you to draw wrong conclusions.

In this sense it’s acceptable to create illusory understanding in communicating mathematics. Your exposition should enable people to navigate correctly between the main ideas in the theory. It’s for you to decide what aspects to focus on and how deeply to penetrate the theory. Perhaps most importantly, your audience should be aware that what they are looking at is just a map, rather than the real thing, with all the caveats this entails.

PostScriptum 2: Joining Forces Together for a Greater Impact

The panel was an occasion for learning success stories from all around the world. Many of these occur within the boundaries each different country. While there are cultural differences between the countries so that the strategies to reach to the public and the schools are not the same from one country to another, it also appears that a greater impact could be achieved at the level of the planet if we increased collaboration. Let us mention a few examples:

- Posters and magazines produced and distributed in one country could be distributed in other countries as well. Worldwide diffusion is particularly easy with electronic material.
- Mathematical exhibitions can travel in several countries, as has been the case for the exhibition “Mathematics is everywhere”.
- Public lectures can be video-taped and placed on the web.

Christiane Rousseau used the opportunity of this item of discussion to invite the world community to join the initiative *Mathematics of Planet Earth 2013*:

www.mpe2013.org

Günter M. Ziegler pointed to the new website

www.mathematics-in-europe.eu

created and maintained by Ehrhard Behrends (FU Berlin) on behalf of the European Mathematical Society.

The Role of Mathematicians in Popularization of Mathematics

Christiane Rousseau*

Abstract

We discuss the role of mathematicians in popularization of mathematics and science. We stress the importance of the message: the message should be scientifically significant. It should strike the imagination, so that a lasting effect remains from its reception. We also discuss how to prepare the message. This is illustrated by examples.

Mathematics Subject Classification (2010). Primary 97A80; Secondary 97A40.

1. Why Should Mathematicians be Involved?

Preamble. *The text below reflects my personal views on the popularization of mathematics. There is not a unique method to do good popularization of science and mathematics. The different methods stick to the personality of the scientists, and the public should benefit from the richness of different personalities.*

The reasons for mathematicians to be involved are numerous. Science in general, and mathematics in particular, is not well understood from the public. We hear too often:

“Hasn’t everything been found in mathematics? What is mathematics useful for?”

We are certainly partly responsible for this. And, this is not without social consequences:

- The power of mathematical ideas and problem solving for scientific or technological breakthroughs is not sufficiently recognized. This results

*The author is supported by NSERC in Canada.

Department of Mathematics and Statistics and CRM, Université de Montréal, C.P. 6128, Succ. Centre-ville, Montréal (Qc), H3C 3J7, Canada. E-mail: rousseac@dms.umontreal.ca

in insufficient funding and support for our discipline. But also, a better recognition of the importance of mathematics would help ensuring more jobs in industry for graduates in mathematical sciences.

- Mathematics could be better taught in the schools if a perspective of where we need to bring the students was more widely spread.
- In many countries we are faced with the fact that too few high school students choose to do mathematics and science.

The questions above deserve an answer. If the answer is given by a mathematician, then another message goes through: the mathematician is a human person. Similarly to a kid, he (she) repeatedly asks questions. Through his (her) deep understanding of the subject, the mathematician can instil the flavor of the discipline. The passion is important for the message to go through and, at the same time, the modesty to admit the limits of the scientist, and the many questions to which we can only answer “I don’t know.”

Not all mathematicians need be involved in popularization of mathematics. This requires a passion for communication, which we do not necessarily all share. On the other hand, improving our communication skills when involved in popularization activities helps improving the quality of our teaching: we introduce a distant horizon and place our subject inside a wider scope, we introduce links with other mathematical subjects and scientific disciplines, we show applications, we stick to crystal clear explanations and we introduce strong messages through our teaching.

The paper is organized as follows. Section 2 deals with the message: the content, a long list of examples, and my own guidelines to prepare it. The two last sections each contain a detailed example. On a first reading one may want to skip part of the list of examples of Section 2, and go directly to Sections 3 and 4.

2. The Importance of the Message

2.1. The content of the message. In order for the message to go through, it should not be too technical. A dream when you do popularization of mathematics is that the listeners of your lectures or the readers of your papers can, in turn, explain part of it. For this, it helps if they have felt a skeleton around which the message is built. What is the spine? The central part could take the form of a slogan or a leitmotiv. The leitmotiv should be sufficiently well illustrated that it is digested and remembered.

Let us give examples. Some are not from me, but they are so good that they deserve to last. The list is quite long.

1. *Mathematics makes the invisible visible.* You observe an object that looks complicated to you, and that you do not understand. You turn around

it to look at it from different points of view. *You put your mathematical glasses and you understand it.* Let us go through a few examples:

- A fractal is a complex object. But it could be the attractor of an iterated function system which is a simple mathematical object. This will be illustrated in Section 3.
- The Fourier series, or Fourier transform, or any other similar transformation like a wavelet transform, allows to understand the structure of a musical sound, of a signal, or of an image.
- Biologists do not see the action of enzymes on DNA. Analyzing the resulting knots through the mathematical glasses of knot theory allows to *see* the action of a given enzyme on DNA.
- Changes of coordinates allow to understand complicated mathematical objects: conic curves reduced to normal form in an orthogonal frame, diagonalization of linear operators, etc.
- The surprising laws of special relativity are better understood when moving in a space of dimension 4.
- A breakthrough in the understanding and control of chaos comes from the identification of the simple dynamical system that generates it.

2. *Mathematics provides models to the other sciences.*

- Polyhedra are models for the big carbon molecules called fullerenes.
- Knots are models for DNA strands inside a molecule.
- Manifolds are models for the Universe.
- Fractals provide models for the forms of nature: this includes the profile of rocky coasts, the shape of plants like the fern, the network of blood vessels in the human body, the fractal structure of the lung.
- The laws of nature often obey optimization principles.
- It is remarkable that nature seems to distinguish between rational and irrational numbers (even diophantian and Liouvillian irrational numbers, but this is too sophisticated for the public). Two examples, very far apart, are given by the golden number in phyllotaxy and the holes in the belt of asteroids in the Solar system, these corresponding to periods being rational multiples of the period of Jupiter.

3. *Mathematics makes predictions.* The examples are numerous among, for instance, statistics, actuarial science, meteorology, genetics, etc.

4. *Mathematics classifies objects.* Classifying is introducing equivalence relations. Important tools are *invariants*. We can make the links with the

invariants used by, for instance, biologists, when they classify the species. Here again, we like to take the time to discuss a few examples:

- *How to classify the shapes of nature?* The biologist Harry Blum, specialist of morphology, uses the concept of skeleton (or sym-axis) of a shape, [2]. The skeleton of a planar region is a graph. In the special case of a simply connected region, it is a tree. Hence, we are led to the classification of tree graphs. Let us cite Harry Blum: “*The exciting thing now is that non-topological properties of the object or its boundary become topological properties of the sym-axis. . .*”
 - *When are two knots equivalent?* Simple invariants are given by the minimal crossing number. Some polynomial invariants can also be sketched to the public. It is quite remarkable that the tools introduced by the mathematicians to construct polynomial invariants for knots, namely skein relations, resemble exactly the operations of some enzymes on DNA.
 - *The topological classification of closed compact oriented surfaces by means of the genus.*
 - *The classification of friezes and tilings by means of their symmetries.* In three dimensions, there are applications to crystallography.
 - *Are all configurations of the faces of the Rubik cube possible?* The use of invariants allows to answer the question.
5. *Mathematics is a living discipline within science and technology.* The examples of cross-fertilization of mathematics, science and technology are numerous. One of them is quantum computing where Shor’s algorithm to factor large integer numbers on a quantum computer, and hence break the RSA code, has been proved before the quantum computer ever exists. Other examples will be discussed in the section on clever ideas.
6. *The importance of a clever idea for a scientist.* There are many important breakthroughs coming from clever ideas that are simple to illustrate. Let us name a few.
- The RSA cryptographic code makes a positive use of the negative fact that computers cannot factor large integers: it is impressive that the RSA code is still in use after more than 30 years, despite the attempts to break it by many of the best researchers around the world.
 - A second example is given by the success of Google’s PageRank algorithm. The simple idea of using the stationary state of a Markov chain process to order pages is the secret of the supremacy of Google over the other search engines. This example is discussed in more details in Section 3.

- A third example, also discussed in Section 3, is the use of iterated function systems for image compression.
7. *There is no limit to the imagination of a scientist.* If a mathematician encounters a problem without solution, then he/she may create an object solution of the problem. Historically, this has led to the creation of negative numbers, complex numbers, infinite ordinals and cardinals. Also, mathematicians play with infinitesimally small or large objects.
 8. *The existence of unifying ideas inside mathematics or science.*
 - The concept of skeleton discussed above in morphology appears in many areas of science, including physics, where it was probably first introduced when considering the propagation of wave fronts, and computer science, where it is used for 3D modeling.
 - Banach's fixed point theorem, one of my favorite examples, appears in many areas of mathematics and its applications. It will be discussed in more detail in Section 3.
 9. *Mathematicians introduce new concepts and generalize.* For instance, the introduction of fractals has brought the generalization of the notion of dimension. Fractal dimension is now used by engineers when they need to measure the roughness of a surface. It is also useful in medical diagnosis of cancer since the fractal dimension of blood vessels is different in the neighborhood of a tumor.
 10. *Mathematicians and scientists make mistakes, but these mistakes can be source of creativity.* An example is given by the Lagrange cylindrical column which was wrongly conjectured to be the strongest column of revolution with a given volume and a given height. The correct answer was given in 1992 by Cox and Overton [4] (see Figure 1).



Figure 1. The strongest column.

Through all these examples, I have addressed some of the possible ways a mathematician thinks. When you read this enumeration, you certainly noticed that I missed some. . . So, it will be your turn to develop your favorite message.

2.2. My own guidelines to prepare the message. The danger for a scientist going into popularization is to be too technical and/or too long. If you are involved in popularization of mathematics, there is no need to choose a subject that is close to your research interests. Choose a subject that is both scientifically significant, and likely to bring a strong message.

It is important to address all people in the audience. The message should be adapted to the less learned, and one should never be intimidated, nor change the message, because there are mathematicians in the audience. At the same time, the message should be sufficiently scientifically sound that anyone in the audience, including the scientists, be interested.

In order to avoid being too technical, here is how I prepare my contributions. I never start sitting at my desk or with my laptop. If I do so, then, most probably, my talk or paper will be too technical. Rather, I try to imagine my contribution when jogging, or skiing, or riding my bicycle, or a similar activity. Then I have no choice: I cannot take a pencil or a piece of chalk for my explanations. Therefore, these will be as synthetic as possible. Also, I figure what is the shortest path to illustrate the message I want to convey. It is only when I have completely visualized my contribution that I sit at my desk, and write the details. Of course, this does not mean that I do not put technical details. But, I stick to the minimum. Even, the choice of details is done so as to convey a message: it could insist on the power of a clever idea, the elegance of a small piece of proof, etc.

3. An Example

In many cultures, we find images containing an embedded smaller copy of the image. One of them is the Laughing Cow and her earrings (Figure 2). Let us play the following game. To each point P of the picture we associate the corresponding point on the left earring, which we call $f(P)$: to the tip of the chin, we associate the tip of the chin of the cow on the left earring, etc. We iterate and look for $f^2(P) = f \circ f(P)$, \dots , $f^n(P) = \underbrace{f \circ f \circ \dots \circ f}_n(P)$, \dots We

can already remark three things:

- (i) In theory, we can continue this process an infinite number of times and create an infinite sequence.
- (ii) In practice, on the figure, we cannot iterate for very long, since iterates become indistinguishable.



Figure 2. The famous Laughing Cow.

- (iii) If we start with a second point Q , for instance the tip of the right ear of the cow, then the iterates $f^n(Q)$ also become indistinguishable. Moreover, very soon, $f^n(Q)$ becomes indistinguishable from $f^n(P)$.

The morale of (i) is that mathematicians have imagination and like to play with infinite sequences. Considering (ii), a natural reaction is to zoom, i.e. to decrease the threshold at which we stop distinguishing points. The deeper the zoom, the more distinguishable iterates we see. But, whatever a zoom we make, using a magnifying glass, a microscope or an electronic microscope, only a finite number of elements of the sequences are visually distinguishable and the others are merged together, since closer to each other than the new threshold. Well, we have *experienced* the notion of a Cauchy sequence. Now, what about (iii)? Can we imagine that there exists a point A which coincides with its image $f(A)$? Surely, if such a point exists, it must lie in the left earring of the cow. And inside the left earring of the cow appearing on the left earring, etc. If such a point exists, it will be indistinguishable from the indistinguishable points $\{f^n(P)\}_{n \geq N}$ for any P . So, we are reasonably convinced that such a point exists, and that it is located inside the bunch of indistinguishable points, up to the threshold of our eye. But, we have done much more. We have given a method to construct it! We start with any point P_0 , and we construct the sequence $\{P_n = f^n(P_0)\}_{n \in \mathbb{N}}$. We choose a precision a priori. Once the points of the sequence become indistinguishable for that precision, we have located our fixed point with a pretty good accuracy. And we have *experienced* Banach's fixed point theorem through its proof.

The next thing that we need to experience is that we can do big things with this theorem. So let us look at a few applications.

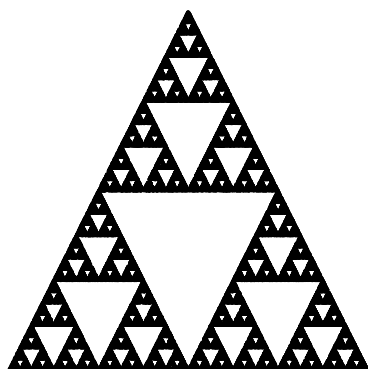

Figure 3. The Sierpiński carpet.

3.1. Compression of images through iterated function systems. Let us consider the Sierpiński carpet of Figure 3. It looks a priori a complicated object. How to store it in computer memory, in the most economical way? The best is to store a program to reconstruct it when needed. And the clever idea behind this program is the use of Banach's fixed point: the Sierpiński carpet is the fixed point of an operator defined on compact subsets of the plane. But, we need not go into these fine details to illustrate the process.

Let us first analyze our Sierpiński carpet: it is the union of three Sierpiński carpets. Starting from the Sierpiński carpet, we can construct a second figure with the following procedure:

- We shrink the Sierpiński carpet to its half size from the lower left vertex.
- We make a second copy of this half Sierpiński carpet and glue it on the right.
- We make a third copy of this half Sierpiński carpet and glue it on the top.

The second figure we have built is identical to our initial Sierpiński carpet. So the Sierpiński carpet is the fixed point for this process.

Can we play the same game with other shapes? Let us take a square C_0 (Figure 4(a)). Its image is C_1 in Figure 4(b). We apply the same process to C_1 and get C_2 , etc. (Figure 4(c)-(f)). One is easily convinced that the process converges to the Sierpiński carpet.

Not only that, but we can experiment that it works with any initial set! A second example iterating a pentagon appears in Figure 5. The same remarks (i), (ii) and (iii) as above apply to this example.

In mathematical terms, what have we done? We have three affine contractions T_1 , T_2 and T_3 . If we call A the Sierpiński carpet, we have constructed the sets $T_1(A)$, $T_2(A)$ and $T_3(A)$ and the image $T_1(A) \cup T_2(A) \cup T_3(A)$, and we have

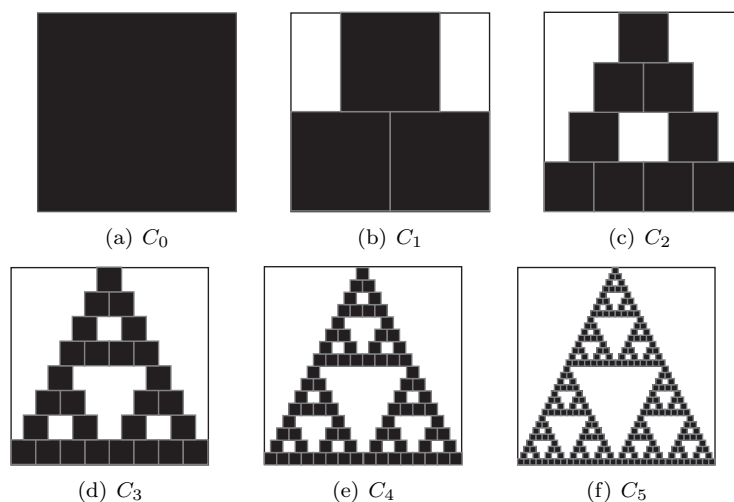

Figure 4. C_0 and the first five iterations C_1-C_5 .

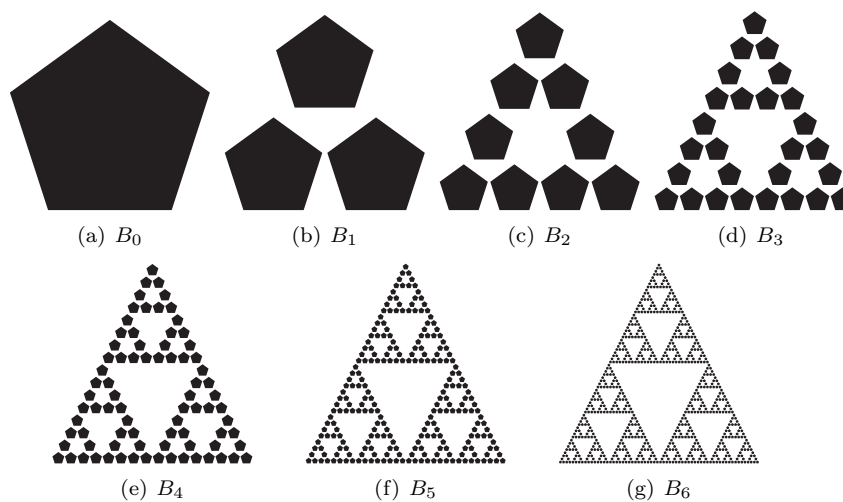

Figure 5. A pentagon B_0 and its first six iterates B_1-B_6 .

remarked that this image is identical to the initial image:

$$A = T_1(A) \cup T_2(A) \cup T_3(A).$$

If, instead of A , we take another subset B of the plane, we construct the set $T_1(B) \cup T_2(B) \cup T_3(B)$. So we have defined an operator W on compact subsets of the plane through the rule

$$B \mapsto W(B) = T_1(B) \cup T_2(B) \cup T_3(B),$$

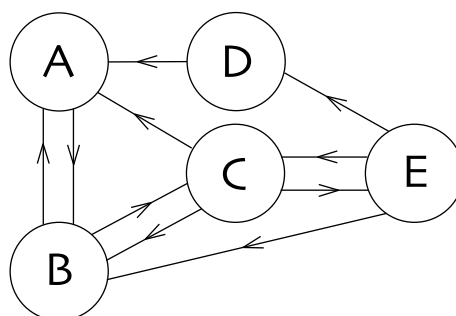

Figure 6. A simple web.

and the process has constructed the Sierpiński carpet which is the unique fixed point A of W .

This process has been adapted to the compression of real images (see [5] or [7]). The method produces high quality images when the image has some fractal character. However the rate of compression is not as good and not as flexible as the JPEG format. Also, the encoding process (transforming the image in a program to reconstruct it) is still too tedious to be of practical interest. Nevertheless, the idea remains very appealing.

3.2. The PageRank algorithm. How does Google order the pages of the web? Let us look at a simple web in Figure 6 with five pages named A , B , C , D , and E . The web is modeled by a oriented graph in which the pages are the vertices. The arrows represent the links on each page. For instance, if we are on page C , we find three links, and we can choose to move to either page A , or B , or E . On the other hand, if we are on page A , then there is only one link to page B .

Here again, we play a game, which is simply a random walk on the oriented graph. Starting from a page, at each step we choose at random a link from the page where we are. For instance, in our example, if we start on page A , then we go to B with probability 1 while, if we start with B , then we can do to A or to C with probability $1/2$ for each case. We iterate the game. Where will we be after n steps? To automatize the process, we summarize the web in the following matrix, where each column represents the departing page and each row the page where we arrive.

$$P = \begin{matrix} & \begin{matrix} A & B & C & D & E \end{matrix} \\ \begin{pmatrix} 0 & \frac{1}{2} & \frac{1}{3} & 1 & 0 \\ 1 & 0 & \frac{1}{3} & 0 & \frac{1}{3} \\ 0 & \frac{1}{2} & 0 & 0 & \frac{1}{3} \\ 0 & 0 & 0 & 0 & \frac{1}{3} \\ 0 & 0 & \frac{1}{3} & 0 & 0 \end{pmatrix} & \begin{matrix} A \\ B \\ C \\ D \\ E \end{matrix} \end{matrix}$$

It is not difficult to figure that the probabilities after two steps can be summarized in the matrix P^2 .

$$P^2 = \begin{pmatrix} A & B & C & D & E \\ \frac{1}{2} & \frac{1}{6} & \frac{1}{6} & 0 & \frac{11}{18} \\ 0 & \frac{2}{3} & \frac{4}{9} & 1 & \frac{1}{9} \\ \frac{1}{2} & 0 & \frac{5}{18} & 0 & \frac{1}{6} \\ 0 & 0 & \frac{1}{9} & 0 & 0 \\ 0 & \frac{1}{6} & 0 & 0 & \frac{1}{9} \end{pmatrix} \begin{matrix} A \\ B \\ C \\ D \\ E \end{matrix}$$

Experimentation shows that for n large, all columns of P^n are identical:

$$P^{32} = \begin{pmatrix} A & B & C & D & E \\ 0.293 & 0.293 & 0.293 & 0.293 & 0.293 \\ 0.390 & 0.390 & 0.390 & 0.390 & 0.390 \\ 0.220 & 0.220 & 0.220 & 0.220 & 0.220 \\ 0.024 & 0.024 & 0.024 & 0.024 & 0.024 \\ 0.073 & 0.073 & 0.073 & 0.073 & 0.073 \end{pmatrix} \begin{matrix} A \\ B \\ C \\ D \\ E \end{matrix}$$

After n steps, where n is sufficiently large, the probability of being on a page is independent from where we started! For a mathematician, this can be explained from the fact that P is the matrix of a Markov chain, and such a matrix generically has a unique eigenvector π of the eigenvalue 1, normalized so as to be a probability distribution, and called the *stationary distribution*. (More details in [7].) This stationary distribution allows to order the pages. In our example, we order the pages as B, A, C, E, D and we declare B the most important page.

In practice, given any vector $\mathbf{p}_0 = (p_A, p_B, p_C, p_D, p_E)$, representing the probabilities of starting on any given page, the sequence $P^n \mathbf{p}_0^t$ converges to the stationary distribution π^t . This is because the map $\mathbf{p} \mapsto P\mathbf{p}$ is a contraction on the complete metric space of probability vectors. (This space is a 5-simplex.)

Once again, we have seen Banach's fixed point theorem providing an elegant solution to an important problem. And again, we could observe properties (i), (ii) and (iii).

3.3. Coming back to Banach's fixed point theorem. As mathematicians, we know the importance of this theorem in mathematics, because of its numerous applications in differential equations. These more exotic applications have demonstrated this fact to the public also. As for the leitmotiv, we have illustrated, both the importance of a clever idea to make a breakthrough, and the existence of unifying ideas or concepts.

4. A Second Example

After having explained the importance of the message, let us come to a second example for which the message is less scientific than the ones listed before. But, there is a link with the Laughing Cow of Section 3.

You may have heard of the completion of Escher's lithography by Hendrik W. Lenstra and Bart de Smit [6]: see for instance

<http://escherdroste.math.leidenuniv.nl/>

Let us first summarize the mathematics of the process. We start with an image which is reproduced inside itself, like the Laughing Cow. In mathematical terms, we say that the image is invariant under $z \mapsto Cz$ where $|C| < 1$. So all points $\{C^n z\}_{n \in \mathbb{Z}}$ have the same color. We will apply a transformation

$$z \mapsto w = f(z) = z^\beta$$

for some $\beta \in \mathbb{C}$. How is chosen β ? If we start with some z_0 and we make a turn around the origin we come back to $z_0 e^{2\pi i}$. (Here we choose the positive direction, but we could choose the negative direction as well.) Since f is ramified we choose β so that $f(z_0 e^{2\pi i}) = f(Cz_0)$, yielding $z_0^\beta e^{2\pi i \beta} = C^\beta z_0^\beta$. Hence, $\beta \ln C = 2\pi i(\beta + k)$, for some $k \in \mathbb{Z}$. For instance, if we take $k = 1$, then

$$\beta = \frac{2\pi i}{\ln C - 2\pi i}.$$

In practice, this can be accomplished through the following sequence of transformations:

- $z \mapsto Z = \ln Z$: in the Z -coordinate the image has the infinite set of periods $\{k_1 \ln C + k_2(2\pi i) | k_1, k_2 \in \mathbb{Z}\}$, which is generated by $T_1 = \ln C$ and $T_2 = 2\pi i$, but also by $T_1 = \ln C$ and $T_3 = \ln C - 2\pi i$.
- $Z \mapsto W = \beta Z$: again, the image is doubly periodic. Then, the set of periods is generated by $T_4 = \beta T_1$ and $T_2 = \beta T_3 = 2\pi i$.
- $W \mapsto w = e^W$: the period T_2 guarantees a uniform (non ramified) image. The final image is invariant under $w \mapsto C^\beta w$, where $C^\beta = e^{T_4}$.

To complete Escher's lithography which is in the w -coordinate, Hendrik W. Lenstra and Bart de Smit brought it back to the z -coordinate, filled the hole and returned to w -coordinate.

But how to explain this to a non-mathematician? We will make a film of these transformations on the simple example appearing in Figure 7. We should imagine that the image is on a table cloth in 3-dimensional space (Figure 8). We lift the (elastic) table cloth by its center, thus transforming it into a cone (Figure 9). During the process, the unit circle is kept fixed in the plane. We observe that the multiplicative period tends to 1 and that, in the limit, we

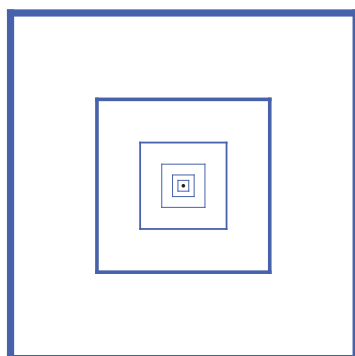

Figure 7. The initial image.



Figure 8. The initial image in 3-dimensional space.

observe a translational symmetry on the cylinder in Figures 10(a) and 11(a). If we suppose that the cylinders are rolls of paper with identical images on each sheet and we unroll the cylinder on the left (resp. right), we obtain the image in Z (resp. W) coordinate which is doubly periodic.

The last step is simply the inverse process to the one represented in Figure 9 starting from the cylinder in Figure 10(b) or 11(b). It is represented in Figure 12, and the final image appears in Figure 13.

Now, how can we put this transformation in equation? To transform a plane into a cone we apply $z \mapsto z^\alpha$. But we must at the same time send the origin to ∞ and keep the image of the unit circle of length 2π . So the transformation is $z \mapsto \omega(z, \alpha)$, where

$$\omega(z, \alpha) = \begin{cases} \frac{z^\alpha - 1}{\alpha}, & \alpha \neq 0, \\ \ln z, & \alpha = 0, \end{cases} \quad (1)$$

and we let α decrease from 1 to 0. From its form, the transformation is conformal in z for all α . The function $\omega(z, \alpha)$ is simply the unfolding of the function $\ln z$. In dynamical systems, it is called the *Leontovich-Écalle-Roussarie compensator*. In statistics, it is called the *Box-Cox transformation*. It may exist in other areas of mathematics.

A 2-dimensional animation of this process has been programmed by Philippe Carphin and can be visualized at:

<http://accromath.uqam.ca/contents/Animation.wmv>

What is the message behind this example? Maybe that mathematics is a form of art, and that mathematicians and artists eventually share the same dreams...

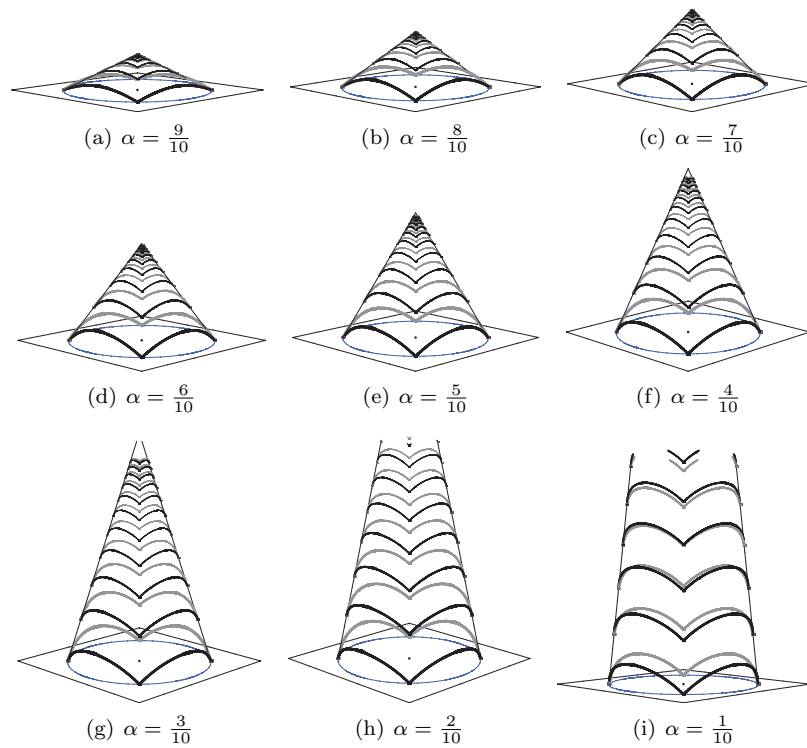

Figure 9. Lifting the image by the center. (Note: the parameter α refers to the transformation $\omega(z, \alpha)$ used to produce the figure and discussed in (1).)

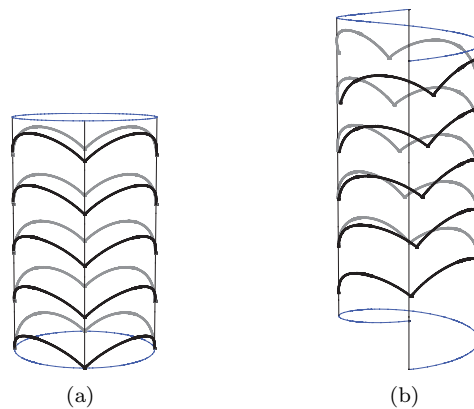

Figure 10. The image on the cylinder. The image on the right is obtained by cutting the left cylinder along a vertical line, sliding the sides by one period and scaling so that the horizontal section remains of radius 1.

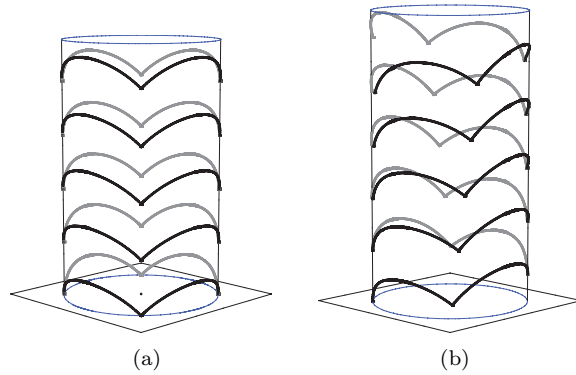

Figure 11. The same images on the cylinder as in Figure 10, with the horizontal plane represented.

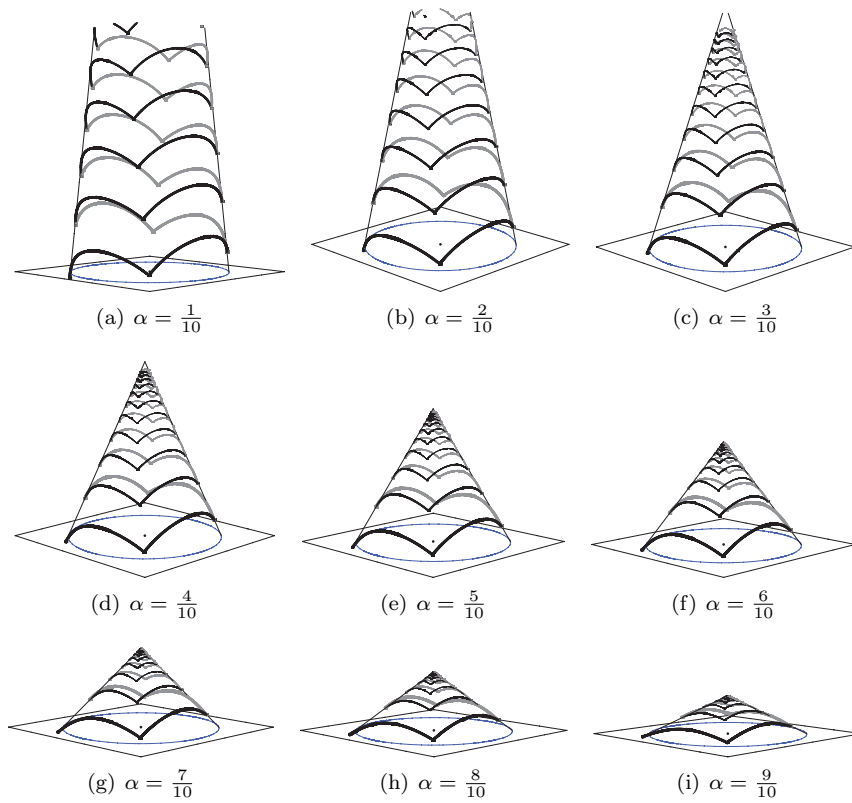

Figure 12. Back from the cylinder to the plane.

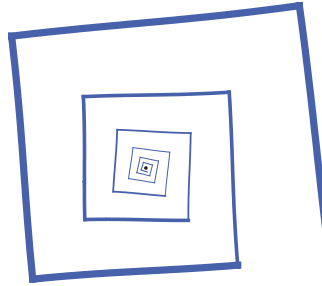

Figure 13. The final transformed image.

References

- [1] M. F. Barnsley, *Fractals everywhere*, San Diego, Academic Press, 1988.
- [2] Blum, H., Biological shape and visual science (Part I), *J. Theoretical Biology*, **38** (1973), 205–287.
- [3] P. Carphin and C. Rousseau, The completion of Escher’s “Print Gallery”: a dynamical system approach, preprint, 2008.
- [4] J. Cox, The shape of the ideal column, *Mathematical Intelligencer*, **14** (1992), 16–24.
- [5] J. Kominek, Advances in fractal compression for multimedia applications, *Multimedia Systems Journal*, vol. 5, n° 4, 1997, 255–270.
- [6] B. de Smit and H.W. Lenstra, Artful mathematics: the heritage of M. C. Escher, *Notices of the AMS*, **50** (2003), 446–451.
- [7] C. Rousseau and Y. Saint-Aubin, *Mathematics and technology*, SUMAT Series, Springer-Verlag, 2008.

Round Table: The Use of Metrics in Evaluating Research

J.M. Ball*

The use of metrics for evaluating research is a hotly debated issue. The IMU/ICIAM/IMS report on Citation Statistics [1] highlighted the dangers of uncritical use of impact factors, which play an increasing role in funding, promotions and library purchases. Are impact factors and other such indices good measures of journal quality, and should they be used to evaluate research and individuals? What can be done about unethical practices like impact factor manipulation? Is there a role for metrics in evaluating research? Are there better alternatives?

These were the topics of discussion at the ICM 2010 Round Table on Thursday, 26 August, between 6 and 8 p.m. It was chaired by John Ball, and organized by IMU's Committee on Electronic Information and Communication (CEIC).

This record of the Round Table consists of edited and shortened versions of the presentations by the panellists, together with excerpts from some of the contributions by participants in the discussion. A complete video is available at the IMU website <http://www.mathunion.org/publications/historic-material>.

Introduction of the Panellists

John Ball. Good evening. I'm substituting for the IMU President, László Lovász, who is actually here but has some problem with his eyes that make it difficult to be in front of bright lights. This round table is a sequel to the 2008 Citation Statistics Report, which was a joint report of the International Mathematical Union, the International Council for Industrial and Applied Mathematics and the Institute of Mathematical Statistics. The writing group for that report was chaired by John Ewing, who was then Executive Director of the American Mathematical Society. This report had a very good reception and

*Mathematical Institute, University of Oxford

it drew attention to the dangers of uncritical use of the impact factor as a statistical measure of journal quality. We have a very interesting panel:

Doug Arnold is Professor of Mathematics at the University of Minnesota in Minneapolis and currently is President of SIAM.

Malcolm MacCallum is the Director of the Heilbronn Institute at the University of Bristol, and was a consultant on the United Kingdom Research Excellence Framework, which is going to be the next evaluation of research in the UK.

José Antonio de la Peña was Director of the Mathematical Institute at the National University of Mexico and is a former President of UMALCA, the Mathematical Union of Latin America and the Caribbean, and he is currently Deputy General Director for Science at the National Council for Science and Technology, Mexico.

Frank Pacard is Professor of Mathematics at the Université Paris Est-Creteil, and is Scientific Advisor of Mathematics in the French Ministry of Higher Education and Research.

Presentations by the Panellists

Doug Arnold. I will focus mostly on one research metric: the Impact Factor (IF), which is simply the average number of citations made in a given year to a journal's papers from the preceding two years. It is intended as an easily used journal quality measure, but, as I will demonstrate, it is fatally flawed.

The Citations Statistics report found many failings in the IF design as a proxy for journal quality, but I am going to focus on something else: Goodhart's law and IF manipulation. Goodhart's law states that: 'When a measure becomes a target, it ceases to be a good measure'. An example used in economics is that if a nail factory in a centralized economy is judged on the number of nails produced, pretty soon they will figure out they should make lots and lots of tiny nails. If it is judged on the weight of the output, they will start making very big nails. The metric ceases to be an accurate proxy for the more complex attribute, say productivity, which was intended.

How do people manipulate the IF? One way was demonstrated by an editor of *Journal of Gerontology A*. Every January, he would write a review article citing all the articles of the preceding two years, and so acquire 200 impact factor citations, more than most math journals get altogether. Another approach is that 'the editor cultivates a cadre of regulars, who can be relied upon to cite themselves and cite the journal shamelessly'. Such a bargain between authors and editors is difficult to detect. Authors are often under citation pressure, but the editors of the *Balkan Journal of Geometry and Applications* put it in their instructions to authors: '[it] is advisable for each accepted paper to contain citations to articles published during 2006-2008 in our journals'.

In order to determine to what extent such manipulation is actually damaging the IF, I compared it to expert opinion, for which I used a journal ranking carried out with broad and careful expert consultation as part of an Australian research assessment exercise. This study [2] demonstrates that many of the bottom class, B and C, journals have higher IF than a significant proportion of the journals that are judged by experts to be the best in their subfield. The grossest anomaly is The International Journal of Nonlinear Sciences and Numerical Simulations (IJNSNS), which has had the highest IF in all of applied mathematics by a large margin for the last four years running, although as a B-rated journal there are roughly a hundred journals in front of it according to the Australian rating. Working with librarian Kristine Fowler, I studied this case in detail.

Which authors gave IJNSNS all those citations? It turns out that 30% of the citations were from just three authors, and these were the Editor-in-Chief, who cited his own journal 243 times in the IF window, and two other editors. (For control we looked at high reputation journals in applied mathematics, and found it is rare to have more than a few citations come from a single author). As a second approach, I looked at the highest citing journals for IJNSNS. First place is a single issue of the Journal of Physics Conference series, which provided 294 citations. This was the proceedings of a conference that the IJNSNS Editor-in-Chief organised and controlled the peer review for. The next highest citer was a special issue of a different journal that was again organised by the Editor-in-Chief of IJNSNS. Similar issues arose with other highly citing journals, so that more than 70% of the citations were under the immediate control of the IJNSNS editorial board. A different sort of check is to look at the citations outside the IF window. With IJNSNS, 72% of their citations are in the two years that count for the IF and only 28% in all the other years. With SIAM Review, for example, it is the very opposite: only 8% fall in the IF window.

Although I have been mainly concerned with journals, the people who make the IF say their citation database ‘can rank top countries, journals, scientists, papers and institutions’. Who do they think is the top mathematician? Ji-Huan He, the Editor-in-Chief of IJNSNS! He was named by them as a ‘Rising Star’ in Computer Science; he had a ‘New Hot Paper’ in Physics, another one in Mathematics; a ‘Fast Breaking Paper’ in Engineering. And then in 2007-2008, they named 13 scientists in all of science as ‘Hottest Researchers of the Year’, and he was the only mathematician, a performance he repeated the next year.

To conclude, there is little doubt that IF is highly flawed as an indicator of journal quality. I showed how a journal which is roughly number 100 in applied mathematics moved itself up to number one. There are certainly many other cases in which journals manipulate the IF more subtly, moving themselves up (and so moving more honest journals down) five or ten places. We cannot expect an easy formulaic fix. If we agree to judge quality by counting citations, Goodhart’s law indicates that we will fail. However, there is a need, e.g. for library purchase decisions, for an easily consulted indicator of journal quality.

The IMU and ICIAM have discussed this and taken a big step forward this month by resolving to develop a plan for a joint ICIAM/IMU method of rating journals, based on expert opinion. This has the potential of providing truly useful information to those who need it, while returning the process of judgement to us, the experts.

Malcolm MacCallum. I think a lot of the discussion is going to centre on impact factors and citation indices. I want first to draw your attention to the other sorts of metric used, in particular in the UK Research Assessment Exercise (RAE). It had three headings: ‘Outputs’, ‘Environment’ and ‘Esteem’. ‘Outputs’, essentially papers, and ‘Esteem’ were assessed by peer judgement. In judging Environment, we had about 20 metrics presented to us, for example the number of Research Assistants per full time equivalent members of staff. There was no sane way to use them all.

Some of them were really input measures, and it is very hard to establish how effectively they had created output or knowledge transfer. My own suspicion is that the less income you have, the better you use it. Some are outside institutional control. Some are historical: you may be very attracted to where, say, Hardy worked although Hardy died long ago. In fact, I think too many of them are self perpetuating, rather than reacting to current research quality. Even if you accept them as valid, there are still various ways to use them. For example, in considering the total research income per person against the size of departments, do you reward the department that earned most or the one spectacularly effective with the number of people they have? Kenna and Berche [3] found that in almost all disciplines there is a critical size above which the research quality tails off. Unfortunately this isn’t a very useful message for this assembly because while true for applied, it is not true for pure mathematics.

In the UK, they plan to replace ‘Esteem’ by ‘Impact’, meaning economic, social or cultural but not scientific impact. That has to do with why a government should fund research at all, which is a very fair question. But I think the specific way that they are intending to answer it is not the right one. The Royal Astronomical Society and the UK Institute of Physics, concluded ‘we can’t do it’ and ‘we don’t think it’s doable’ Fabian [4].

Now I want to come back to bibliometric measures. There has been a lot of research on citation data, and the many problems it has, such as consistency, coverage, nationality and gender biases, indexing, ‘obliteration’, discipline size and citation practice etc. (see e.g. Blustin [5], and for fun [6]). In RAE we specifically did not use bibliometric data. But after I had read and assessed each paper, I looked up its citations. That caused me to change my opinion on only two or three of the 400 papers read. So citation information can be useful, but it has to be interpreted with a knowledge of the sociology of the discipline and an understanding of the mathematical content. For the Expert Advisory Group on the replacement for RAE, there was a pilot of looking at citations of individual papers. The resulting data was given to us to compare with our

actual assessments. There was general agreement across all subjects that the bibliometric data could not have been used without some serious injustices.

As a journal editor I find impact factors a useful measure of how we are doing against the competition. But I do not believe one can judge a paper by where it appears: thus I do not agree with Professor Arnold's proposals.

In summary, I have two messages.

1. To bureaucrats: no metric is safe for use without human interpretation. You have to be very careful to realise that correlation does not imply causation. One of my colleagues claimed that the UK ranking of institutions was very tightly correlated with the number of gardeners they employed!
2. To those entirely opposed to metrics: they can be a useful sanity check, providing you don't try to use too many or make them too complex.

Frank Pacard. I wanted to say something about the situation in France concerning the use of citations and metrics to evaluate mathematical research, either by the government or by the universities. First of all, there have been some changes in the French higher education and research system and, to understand how citations and metrics are used, it is very important to understand how the money supporting research is now distributed. In France almost all the money for mathematics comes from the Ministry of Higher Education and Research but it travels through many different channels before it reaches mathematicians. As far as the assessment of research is concerned, the government has created some evaluation agency to this effect. So far, the evaluations from this agency are not based on the use of metrics and complicated impact factors, there is though a definition of an 'active researcher' which depends on the number of publications. Therefore, everything seems to be going smoothly in France with a very limited use of statistics in the assessment of research.

However, looking closer you find that there is also an institution whose work is to provide statistics based on the number of publications and citation. Even though these statistics are not used officially to evaluate a research department, they are becoming more and more popular to measure for example the strength, weakness and evolution of the different fields in a given part of France (for example, all sciences in the south west of France). These data are also available to all actors of the research system. These statistics can be very precise and can cover very different scales : at a scale of a whole country up to the scale of a research department.

For example, in my own university, statistics about the number of publications of the mathematics department (which is a small department) are received and, as you can imagine, interpretation of the data can be rather controversial at such a small scale. French universities are now autonomous and have more freedom in their scientific policy. In particular, to some extent, they can decide to give more support to department A rather than to department B and the government does not provide them with any guide on how to distribute the money among departments. As a consequence, there is more and more pressure

to make use of metrics in order to distribute the money as best as possible, using possibly some very complicated mathematical formula.

Even though French mathematics is very strong, it is fair to say it only corresponds to a very tiny subset of the French research system. What is true at a national level is also true at the level of a university where mathematics departments are now in direct competition with other departments of other sciences whose weights are much bigger and for which the use of metrics seems more natural. This is where I see that there is some danger for mathematics in France. My experience shows that there is a strong temptation to use metrics not necessarily coming from the top of the research evaluation system but also coming from the bottom of the evaluation system, because metrics are a rather quick and convenient way to compare people or departments from different fields!

On the other hand, the use of metrics at a large scale (say the scale of a country like France) is probably worth considering and, carefully analysed and complemented, can give some interesting insight on the strength and weaknesses of a given field. For example, the relative share of publications of French mathematicians in the world has decreased over the past years slightly faster than expected. This is an interesting piece of information but unfortunately, since there is no further analysis of this information, it might be improperly used. Also, people in charge of building the statistics based on publications are well aware that some indices used are not adapted to mathematics (for example, the number of citations in the two years after publication is not very meaningful in mathematics) and they would be very interested in having some more meaningful formula.

To conclude, I would say that the situation concerning the use of metrics in France is still not completely clear. There is some pressure to use them and we have to be very careful in the next years to protect ourselves from improper intensive use.

José Antonio de la Peña. Citation indices, originally designed for information retrieval purposes, are increasingly used for research evaluation. The concern that the consideration of these indices is distorting the evaluation of the individual work has passed, in the last few years, from corridors to main stream journals.

In the developed countries, at least since the second half of the 20th century, science is accepted as a social, cultural and economic asset. Although the relevance of scientific work has been evaluated from decades back, current evaluation practices have a recent history that respond not only to academic needs, but to conceptual changes of political, economic and social character.

In evaluating scientific work, the criteria used are expected to have universal validity (as much geographic, as thematically), to be objective, to be simple to measure and to determine, as far as possible, the quality of the work. The criteria used so far show many limitations and misinterpretations. Notably, the use of impact factor of journals as a measure of the quality of the science

published and, still worse, the quality of the individual papers published in those journals, is an extended practice without a solid support. Even Eugene Garfield has warned against some abuses: 'It is absurd to make comparisons between specialist journals and multi-disciplinary general journals like Nature'.

To check the evaluation practices in Latin American countries, we asked friends from Argentina, Brazil, Colombia, Chile, Mexico and Venezuela. Here I quote just a few answers to illustrate the discussion:

Q1. Are indices (such as number of papers, number of citations, impact factor of journals, h-number, etc) used for the evaluation of mathematicians in your country? If yes, which indices are preferred?

Chile: In general no. Up to now the committees of mathematics agree on the quality of the journals to evaluate the research projects or CV. Sometimes they use, as complementary information in the analysis, some citation indices.

Colombia: In the public universities, the salary of the professors depends on the numbers of papers.

Venezuela: Yes, in some cases. At research institutions, the tendency is to use all those indices to evaluate researchers, but not so much at universities.

Q2. Who promotes the use of these indices (the administration, scientists in general, mathematicians in particular)?

Everybody: the administration, in first place; scientists of other fields, as second.

Q3. Is it considered that the use of indices provides a more: efficient, scientific, fair, objective way of evaluation? Who thinks so?

Most: I guess that some groups of scientists look for efficiency and some kind of 'fairness'.

Q4. In your opinion, what is the effect of the use of these indices?

Most: I believe they do add value to the evaluation, if used carefully and in combination with other parameters.

Argentina: the use of indices is helpful to discriminate between real scientists and those who pretend to do scientific work but have no impact whatsoever.

Chile: I do not know the effect for all areas, perhaps in some of them the systematic use of indices could be useful (but, at the end the prevalence of indices would mean that the work of specialists is not necessary). A systematic use of indices in mathematics will constitute a big catastrophe for its development (an enormous deformation that could affect quality for a long time).

Q5. *Could you give an idea of the general feeling of (dis)satisfaction concerning evaluation among the scientists (in particular, mathematicians) in your country?*

Brazil: The general feeling is actually very positive, among mathematicians and among scientists in general. This is perhaps because the scientific community itself is directly in charge of the evaluation.

Chile: People that have been part of the local evaluation committees say that there is mutual dissatisfaction between mathematicians and other groups of scientists.

Comparing the use of impact factors to measure quality of research with the story of the measuring human intelligence by means of the IQ, we point out the misunderstanding of thinking that a person is intelligent because they have a high IQ. Similarly, we are pushed to believe that a scientific paper is good because it is published in a journal of high impact factor. This is my last argument: I would call it the mismeasure of science, to keep the parallelism with the situation described by Stephen Jay Gould. It is a complete misconception to transfer the value, whatever the impact factor measures, from journals to articles. It should be made in the converse way, after all, a journal is not more than a collection of papers. The only meaningful definition for the impact factor of a journal is the mean value of the impact factor of the papers it publishes. If this is so, it is the impact of a scientific article which should be discussed: is it possible to give a sound definition?

General Discussion

Doug Arnold. While we're waiting for someone to pluck up their courage, let me respond to just one misimpression which may have arisen from Malcolm's talk. He said one cannot judge a paper by where it appears and for that reason didn't like my proposal. So I want to make clear that I agree 100% with Malcolm that one cannot and should not judge a paper by where it appears. In fact in some cases it might be wise to choose a lower impact journal for an excellent paper, for example to help strengthen the journal. My proposal to rate journals is in no way aimed at judging individual papers, and any report that comes out of it would clearly state that. It is a way to get a sense of a quality of a journal for reasons like library purchase decisions, helping the editorial board to know how their work is going and so forth.

George Andrews, Penn State University, USA. I'd like to ask Prof MacCallum, since you say you do not accept Doug Arnold's proposals, I wonder if you are not disturbed by, not the manipulations and outliers, that were in the graph, but the discrepancy that he described between the top level journals, as people assess them, having a lower impact factor than really badly ranked journals.

Any solution is going to have problems, but aren't the problems mitigated somewhat by Doug's proposal?

Malcolm MacCallum. I think that there are certain problems that would be mitigated but what worries me are the ways in which this is likely to be used, and the degree to which it seems to be going along with the idea that you can make judgements by where something appears. I think we should simply be opposing use of data on journals for this kind of purpose. What was shown in the comparison you refer to doesn't surprise me because different journals appeal to different subcommunities or accept papers with a different kind of angle or approach.

Doug Arnold. So I just want to repeat again that there was never any suggestion that one should use the journal quality, no matter how carefully measured and determined, as a way to rate papers, or what you call products of research. I know you have been very involved with rating products of research and you may think that is what this proposal is for. The proposal is to rate roughly, to give a rough idea of what we all know as mathematicians, to put down what we all know about the quality of journals.

Why do we want to do this? We want to do this, for instance, because people must make a decision on which journal their libraries are going to subscribe to. If they don't have enough local expertise in the area then the library must make a decision based on data. Right now they are making such decisions based on seriously flawed data, and we were hoping to replace that with reasonable data which reflects the expert opinions of the people who look carefully at the journals. You can say that people might misuse that, but in fact people are misusing a highly flawed database. We can create one that is less flawed and with clear instructions of what it can be used for and what its limitations are. The fact that somebody might refuse to honor those or do something foolish, is not a reason not to do anything, particularly because what is being done now is much worse.

László Lovász, Budapest, Hungary. So first of all thank you, John, for being out there instead of me. The second remark is that I am a bit envious of Prof Arnold that he lives in a country where it's still the librarians who decide which journal to subscribe to; in many countries it is by bulk subscription by some government agency for all universities in that country, especially for the electronic versions. This is a situation which is a separate question but I just wanted to mention that this is also a very serious concern as far as I can see. My next remark is that I like very much Malcolm's remarks, essentially that the peer review system and numerical data should complement each other. In case there is a discrepancy then it should probably be more carefully looked at. We all know examples where the numerical data gives an entirely false impression, but I have also seen the peer review system run amok, with somebody who was by personality not so well liked or had one enemy in the system, and it

has produced very very strange results. So I think in that case numerical data should have corrected the procedure at some point. So I think the question to look at is which numerical data and how can we use it? Now I am talking about evaluating people not about evaluating journals, these are two different issues.

R. C. Cowsik, Mumbai, India. In India we have journals which publish only to the writers of papers in that journal – no other copies are ever sold. And we also have departments where everybody works in the same subject, a narrow part of mathematics. They quote each other so the citations would be large for them. We have a journal called Annals of Mathematics, India, and India is in small print!

Daya-Nand Verma, formerly at TIFR, Mumbai, India. My question to the entire panel is, isn't there some sort of a parallel between the life of research papers and life of individuals? Educationalists know that all children are not equal, in the same way as you have been pointing out that all research papers are not equal. So sometimes some research paper goes unnoticed, or maybe with very, very few exceptional references by a few people, and has not been referred to for 40 years, 100 years perhaps. Is there a way of devising a system which can pick up these exceptional, high calibre youngsters, so by that I mean the exceptional papers which go unnoticed, just as many high calibre children go not only unnoticed but get punished by the system.

Malcolm MacCallum. As mathematicians we like to have absolute objective truth. One area where there will not be an objective truth is in assessment of papers. It is a human activity and we're inevitably going to make mistakes. I don't think we can do anything but accept that and try to minimise its extent.

Doug Arnold. I would add that I certainly agree with what Malcolm just said. The most we can do is try to be careful when it come to assessing and the way you assess a paper is to read it. Counting the citations, no matter how carefully you count them, is not very helpful. You brought up the very good point that great papers in mathematics often go uncited for a long period. One of the wonderful facts about mathematics is you often see papers that are very highly cited many years after they are written. And another point is that citations come from all sorts of reasons. If a paper has a mistake and there are criticisms and retractions published, those cite the paper and boost its quality according to a foolish, citation-counting viewpoint.

Malcolm MacCallum. In fact I would say if you really want to be highly cited quickly the best way to do it is to write a paper that is just subtly wrong, so that lots of people pitch in to tell you why.

Garth Dales, Leeds, U.K. I would like to ask about possible political action, perhaps particularly addressed to Prof Arnold. I share your doubt about citation indices and I entirely agree that they are seriously flawed, but I see a lot of use in them, and it seems that the IMU and mathematicians don't like

this and they are inclined to try to protest against this or do something. But I regret to say that political realities are that mathematicians are a small group in the overall scheme of things, and my experience is that however cogent and powerful our arguments are that impress us, they have very limited impact on our government and agencies and so on. And I wonder what your assessment is. It seems to be that the only possibility of changing the culture in this particular respect is to find allies in the much bigger subjects of engineering, biology, physics and chemistry. Unless we have allies and friends in these subject areas, we'll have no impact whatsoever on the governments and agencies, or in particular private publishers that make money out of publishing these statistics. So what is your assessment of our chances of finding allies among these subject areas?

Doug Arnold. Well I think that's a very good point and one that has to be raised and thought about quite a lot. I'll make a couple of comments. First of all my comments are limited to impact factor as a journal quality proxy. I am not taking on the bigger question of an individual or departments. If we limit ourselves to pointing out, as many have pointed out, and many will continue to point out, that impact factor is highly flawed, we will go unheard. That has already been done and is basically a proven proposition. It is not only mathematicians who are complaining about this. Many, many groups are complaining about it. I feel that – because we are a fairly small community with a great devotion to our literature and some coherence – that by providing an alternative we have a realistic chance to say: 'Well you know there is an alternative that you can use instead. It is much, much better but just as easy to use. It has the imprimatur of the major math organisations in the world and there is all this evidence that it is better.'

This won't be used for comparing mathematics journals to say geophysics journals, which is meaningless, but for the purposes where you need to make an evaluation and judgement on journals of mathematics. I think this has a chance to come about. I think there is a possibility that people will say 'you know these mathematicians have some integrity and they really are doing this right, and maybe we should see about doing something like this.' As far as building up allies, recently I travelled to Singapore, to the World Conference on Research Integrity. There were 350 delegates including people from ministries of science and so forth. Out of the 350 delegates only I was a mathematician. I spoke a little bit about this proposal and I saw lots of allies and got lots of support. People are actually looking forward to seeing what we are going to be able to do in this area.

José Antonio de la Peña. Well I think it's important that mathematicians take a position with respect to the indices, and maybe propose new ways to measure the impact of journals. But even what is done now, which is very bad, very flawed for mathematics, like measuring the impact factor of journal using this two years window which is completely nonsignificant for mathematics, could be

changed. For example, why not calculate the impact factors not using the two years window but using the full history of the journal? Just simply that. That can be much more significant for all sciences: why is this not done? I had an opportunity to speak with some high-ranking person from Thomson Reuters and the answer was 'of course we calculate this, we don't publish these results but we do calculate them'. So this means there is a completely different agenda, there's a hidden agenda why they calculate the indices in this way: maybe it is an economic agenda.

Chandan Dalawat, Harish-Chandra Research Institute, Allahabad, India. I just want to know if this new measure or classification on the quality of journal that's been proposed, has it actually been tested and could we look at the results that it gives?

Doug Arnold. No. The situation is the following. First of all, I am the President of SIAM which publishes these journals, so it is not my place to personally set down the mechanics of rating the journals. The proposal, which is brand new, just passed by the IMU General Assembly, is to establish a committee to try to design the best possible system, and then consider the question of how difficult it will be to implement. I can give you just a rough idea of at least what I have in mind, although other people may well change this. This is something akin to the program committee and panels that chose the invited speakers of this congress. That is many people, between 100 or 200, that were carefully chosen to cover many areas of mathematics. There will be a fairly small number of rating tiers, a few tiers or, perhaps, a matrix with separate tiers for journals that are tightly concentrated on one subdiscipline and broad journals, and so forth. Then these experts would review the journals and try to determine where they place them. Maybe there would be a time for public comment. There would be some rule against conflict of interest. Once they present the results, we will get the opportunity to test them. They will need to be renewed every 4 years or something like that. That's what I have in mind.

John Ball. To amplify that a bit, the committee would consider what would be the best way to create such a ranking system, then decide whether to implement that system, and in particular consider some of the issues surrounding such a system, maybe legal implications, whether there would be the involvement from the community to sustain such a system, and what the knock on affect of such a system would be.

Zhiming Ma, China. Several years ago in China this problem was really very serious. For example in China if you apply for a promotion or for a prize you have to submit a document with citations. You maybe have to pay money to an agency or a library and then the agency (library) will type the citations, and then you submit it. This was several years ago; now the situation is getting better because many people complained about this. In China we mathematicians say that maybe people in other disciplines such as biologists will use this but

for mathematics it's not the case. We always ask the agencies or government to distinguish between subjects, so in this way we get some improvement. Now in China (at least in CAS) when mathematicians apply for a promotion or a prize, we will not follow the general rule of metrics. In this sense we are improving.

Martin Grötschel, Berlin, Germany. Somebody said before that we have no influence. This is absolutely not true; I think mathematicians are heard. Here is an example. The 2002 IMU General Assembly endorsed a document about best practices of journal publishing, advice to authors and so on, and open access in particular. This document was taken up in 2003 by the Max-Planck-Gesellschaft in Germany, Germany's top research organisation. MPG and other institutions finally formulated what was then called the 'Berlin Declaration' on open access. IMU's influence was clearly visible in this activity. Hundreds of research organisations worldwide signed this declaration, and mathematicians were the forerunners of this effort.

One can come up with many ways of classifying journals. Of course, targets have to be formulated together with reasons why we want to classify, why we want to sort journals, or people, or departments by quality. Even if we have reasonable arguments for the organization of the system of our journals, we must not only provide information about scientific quality but also about the way authors are handled, the turnover times and all the things that are important for journal publishing. Making available a broad spectrum of relevant information may be an alternative to just addressing the current crude measurements.

The panel addressed totally different targets, for example, whether we rank a paper, a journal, a department, or an individual, or how we compare mathematics to other sciences. We can't handle all these issues in the same way. I personally think that we mathematicians have to simply declare how we would like us and our work be judged; we then have to discuss the evaluation system with our peers in science and in administration. After that we can negotiate with them the way we are in fact judged. Most of the ideas presented here today are good, and our task is to find a reasonable combination of these measurements. My main field is optimisation and what we see in front of us is a multi-objective optimisation problem. There is something like a Pareto set that we have to target for, and which point on the Pareto curve is chosen will depend on local circumstances. We should simply be aware of this fact and spell it out.

Something I was really puzzling about is one of Frank Pacard's arguments. Everyone is happy about being free to make decisions. Now the French government seems to give financial support to the universities and the freedom to distribute it. I think that everywhere in the world you would be happy to have such a situation: you just have to elect a good president and good deans. They ought to have good insight and will determine who is doing good research. Do you really want the bureaucracy to give rules? I think it is better to have good people with good judgement distributing the money.

Frank Pacard. I agree with you, but in France we are passing from a system in which everything was decided at the top to a system in which a lot is decided at a local level. This takes time. Assessment of research is not an easy thing to do at the level of a university. Also, I think that the importance of the use of metrics really depends on how the money supporting research is distributed and this differs from one country to the other. In France, for example, one of the problems we are already confronted with in mathematics is that departments now have to fight against each other inside each university, to get research funds. And, so far, universities have no real way to decide how much support they should give to a given department. Beside the question of research support, there is also the problem of the evaluation of individuals. French universities now have to compare mathematicians with biologists, chemists or lawyers and panels performing these evaluations do not necessarily have mathematicians, biologists or lawyers on them. In this case, as you can imagine, metrics turn out to have a great impact on discussions. One can hope that the system will probably evolve towards a better equilibrium between the use of metrics and peer review, but in French universities I'm not so sure that the system has already reached this equilibrium.

Cheryl Praeger, University of Western Australia. I thought I would say a little bit about the Australian experience. The mathematical scientists in Australia did not choose, that is, did not set out, to rank journals. It was the Australian government that decided that all journals would be ranked. The government dictated the proportion of A*, A, B and C journals. So the mathematical scientists decided that we would prefer to make the ranking rather than have the government do it for us. We ended up having to do it three times; in our first run through we decided to rank as many journals as we could, so we would have more A* and A journals, since we had a fixed proportion available for them. The government did not accept this and we were given a limit on the number of journals we were allowed to rank. Even our second attempt was not accepted and we had to make a third attempt.

We are not terribly happy with it but it is something which has had the support under pressure of the whole Mathematical Sciences community, the pure, applied, the statisticians. Everyone joined together to try and do as good a job as we could. It has not been used yet but it is going to be used in a research assessment exercise, which is happening in the next year. We fear it will be used for other purposes. Already it is being used in an unfortunate way; for example my university proposes to measure research activity of individual staff members by the number of journal papers they publish in A* and A rated journals only, which comprise the top 20% or 30% of the journals according to an imperfect ranking. All other publications will be ignored.

John Ball. Am I not correct in saying that there is also a ranking of conferences, because I saw a listing of this on the Australian website (see <http://www>).

arc.gov.au/era/era_journal_list.htm). So I wondered whether you weren't allowed to go to a conference unless it was an A rated conference.

Malcolm MacCallum. That would have particular relevance in Computer Science where a lot of the best papers come out in refereed conference proceedings.

Hamidou Toure, Burkina Faso. We are a small community of mathematicians in Africa and the administrations are trying to use these different indices. Since the evaluation of publications in journals is done normally by peer review, it will be good that the International Mathematical Union make a peer evaluation of the ranking of different journals. It will be very useful for us.

Jean Lubuma, University of Pretoria, South Africa. I would like to say something about the system which we have in South Africa. I think the colleague from Australia (Cheryl Praeger) said something which is a bit similar. The system in South Africa is such that when you publish a paper, the South African Ministry of Education allocates directly an amount of about 20,000 dollars, which is paid to the university where the research work was done for papers published in the so-called accredited journals. For the moment those are the journals which are in the ISI list. We as mathematicians in the South African Mathematical Societies fought to show the government that this ISI list is not a system which is effective and which is definitely not in favour of mathematicians. The government said 'look, we want a simple method for us to decide' and so far the method which has been suggested came mostly from our colleagues from medicine and biology, because probably that is where all these ideas of the ISI lists originated. So this is the situation which we have at present in South Africa, and unfortunately we tried to fight but it didn't work. So I don't agree with what was said by the Secretary earlier, that mathematicians are powerful. I think I would rather agree with our colleague from England, that we are a very small group and it is not always easy to try and convince our colleagues from biology etc. who publish almost every day.

Jorge Soto-Andrade, University of Chile. I would like to point out that in our country we have some Chilean analogue of NSF and mathematicians have had some word to say concerning assessment of research, but most of the funding for research comes from the government, not directly through the universities. To some extent we have been able to make the point that mathematics is specific, compared with other domains like biology or economics and so on. One of the points is that journals which count for funding for reports are those which you find in this list of ISI or Thomson Reuters. Many people in the government agencies had the idea that ISI was something like IAS or some scientific institute. They didn't realize that it was just a private enterprise with commercial criteria, like Microsoft, Thomson being analogous to Bill Gates.

I would say that the International Mathematical Union is a rather small community but is quite homogeneous and has taken stance in a very significant way in the past, and if we can cite a report or some work of the IMU concerning

these points this will strengthen our position. I would like to recall the report by Figa Talamanca [7] who was very keen from the systemic viewpoint concerning ISI and perhaps some sort of update of this report would be very helpful. It pointed to the fact that the systemic role of ISI in science in the world was a very interesting subject in sociology, and there is a complex dynamic interaction of ISI with big American libraries, with publishers and so on.

One interesting point also is that in our country, which is somewhat free-market oriented, the government had the idea to give rewards to papers and so if your paper is in ISI, you'll get perhaps 1000 dollars, and if it's not there you'll perhaps get just a symbolic reward. One important thing I think is that IMU may have some alternative to ISI. If one looks a little bit, one finds very impressive examples of flaws in ISI reports and listings. For instance you have a list of highly cited mathematicians, highly cited researchers in ISI, and I realized perhaps one or two years ago that no Fields Medallist is a highly cited mathematician.

There is a field in which the situation is even worse than mathematics, which is mathematics education and there perhaps the best journals are not listed in ISI, and there was some reaction which was very positive from IMU and I think this should be pursued. Concerning other scientific communities, I also work with biochemists, biologists and other researchers in cognitive science, fields whose dynamics are quite different from ours, where updated reports from the IMU concerning this issue may help us a lot.

Michel Hébert, Cairo, Egypt. A few years ago the American Mathematical Society has started publishing their own impact factor in MathSciNet. I think it was a result of their own long study. I didn't read the report in detail at that time but remember it was precisely to respond to all these wrong ways for mathematics such as the two year window. So I'm a bit surprised also that there doesn't seem to be any collaboration, or there has been no result. Don't the IMU and AMS know what each other is doing?

Ali Ulas Ozgur Kisisel, Middle East Technical University, Turkey. So in my university our struggle is usually with the university administration, which rarely consists of any mathematicians; however in the mathematics department we have quite a good idea about what should be brought up, and what should be kept down. Maybe I should give some specifics. For instance all the hiring procedures and appointments to posts are based on the number of papers in science core index journals and for instance in order to be an Associate Professor in the Maths department it should be at least 7, and that is a fairly low number, and as you could expect it has drastically different effects if you are studying Applied Mathematics or Modular Forms. So I asked some friend who was working in Ex-Soviet Union how did it happen there? And it was very easy – Kolmogorov decided everything, so no problem! But of course in today's world I guess this is out of the question. But something that we could use, and IMU or global organisations could do, would be to bring forward some experiences from

prestigious universities, like interviews with deans, interviews with department chairs so we could use them in our struggle with our administrations.

Gholamreza Khosroshahi, IPM and University of Tehran, Iran. I work in an institute called the Institute for Research in Fundamental Sciences. In the beginning we were just theoretical physicists and mathematicians and the fight from the beginning started in the committees and the councils about evaluation of mathematics and physics. Physicists usually dominated the issue because of citations and these kind of things and later on other schools like computer science, theoretical computer science, neuroscience, nanoscience were added to our institute. The fight was widened and there are two problems which are always there, one – inside the mathematics council you have to fight – suppose I’m a combinatorialist, at the beginning those who didn’t do any research about 20 years ago said what? Combinatorics? And they were saying that it is easy to publish in combinatorics and it is very difficult to publish say in algebraic geometry etc. So this fight gradually subsided because gradually they had to publish and they couldn’t publish. Then outside of mathematics, physicists used to say always ‘what is the citation on this?’ ‘This paper has 100 citations’ and so forth? This fight still is going on, but I agree with Prof Grötschel that mathematicians should be tough fighters and they should handle these hard situations. We do that and we have succeeded.

One more thing is that we have to prove to others that every discipline has its own culture: culture in mathematics is quite different from culture in computer science or physics.

Gerhard Paseman, USA. There are a number of communities online (such as mathoverflow.net) that are doing rankings of various things, anything from individuals to pizzas. In particular there are some communities forming, scientific communities that exchange information and they do ranking based on reputation, and it seems to me that they are models of some of the things to look at, as examples of what might be a good form of metric, and there are also some obvious mistakes in some of these models, that could probably be avoided by forming a metric. I’m curious to see how metrics for journals, for professional mathematicians, for scientists will actually reflect some of their activity online.

References

- [1] *Citation Statistics*, IMU/ICIAM/IMS report, <http://www.mathunion.org/fileadmin/IMU/Report/CitationStatistics.pdf>, 2008.
- [2] D. Arnold and K. Fowler, *Nefarious Numbers*, <http://arxiv.org/pdf/1010.0278.pdf>, 2010.
- [3] R. Kenna and B. Berche, *The extensive nature of group quality*, EPL (Europhysics Letters), June 2010, 58002.
- [4] A. Fabian, *The impact of astronomy*, Astronomy & Geophysics 51 (2010) 3.253.30.

- [5] A. Blustin, *Publication and citation statistics for UK astronomers*, *Astronomy & Geophysics*, 48(2007)6.326.35.
- [6] J. Zuntz, T. G. Zlosnik, C. Zunckel, J. T. L. Zwart, *Orthographic Correlations in Astrophysics*, arXiv:1003.6064v1.
- [7] A. Figa-Talamanca *Strengths and weaknesses of citation indices and impact factors*, in *Quality Assessment for Higher Education*, Alessandro Cavalli ed., Chapter 8, Portland Press, 2007 <https://www.portlandpress.com/pp/books/online/QAHEE/>.

Mechanisms for Strengthening Mathematics in Developing Countries

Stephen Huggett*

1. Introduction

These are brief notes of the IMU/LMS discussion meeting held on the 25th of August. The meeting was chaired by Angus Macintyre, President of the London Mathematical Society. The panellists were:

- John Ball: member of the MARM Board
- Wandera Ogana: Chair of the AMMSI Programme Committee
- Frank Neumann: an experienced mentor in the MARM scheme
- Felix Shu: a mathematician at the University of Buea, Cameroon
- Ramadas Ramakrishnan: Acting Head of Mathematics at ICTP
- Angel Pineda: active in the Volunteer Lecturer Program

2. Mentoring African Research in Mathematics

John Ball gave a quick overview of this joint initiative by the LMS, the IMU, and AMMSI, which is funded by the Nuffield Foundation and the Leverhulme Trust.

Under the scheme research groups in Africa are paired with individuals and groups in the UK and elsewhere who act as mentors to research students and others. This pairing is done following calls for proposals by AMMSI and for mentors by the LMS (in the LMS newsletter, IMU-Net, and so on).

The key aim is to improve morale and research capability in situ without contributing to a brain drain. African faculty and research students may make short visits to the institution of the mentor.

*Dr Stephen Huggett, Programme Secretary of the London Mathematical Society.
E-mail: s.huggett@plymouth.ac.uk

In the first round the following three partnerships were established:

African University	Mentor's University	Subject
KNUST, Kumasi, Ghana	Leicester, UK	Algebra/Geometry/Topology
Addis Ababa, Ethiopia	Brunel, UK	Analysis
Buea, Cameroon	Heriot-Watt, UK	Mathematical probability

In the second and third rounds a further ten partnerships were established, including mentors from outside the UK, in a wide range of subject areas.

The MARM Board is currently in the process of applying for extra funding to develop the project, to include thematic networks, postgraduate scholarships, initiatives to encourage female mathematicians, use of videoconferencing technology, workshops, and administrative support.

Finally, the report *Mathematics in Africa: Challenges and Opportunities* published by the IMU in 2009 was recommended to delegates. It can be found at:

<http://www.mathunion.org/publications/reports-recommendations>

3. AMMSI

Wandera Ogana introduced the African Mathematics Millenium Science Initiative, which has a distributed network with five regional offices, each run by a Regional Coordinator:

Central Africa Regional Office at University of Yaounde I, Cameroon

Eastern Africa Regional Office (and also Programme Office) at University of Nairobi, Kenya

Southern Africa Regional Office at University of Botswana, Botswana

Western Africa (Zone 1) Regional Office at University of Ilorin, Nigeria

Western Africa (Zone 2) Regional Office at University of Ouagadougou, Burkina Faso

Between 2005 and 2008, 23 research or visiting fellowships have been awarded, for short visits by staff to host institutions, to conduct research and train postgraduate students. Most of these were for African mathematicians to visit African institutions. This scheme has been suspended now because the Mellon Foundation grant has ended.

Under the Postgraduate scholarships scheme, AMMSI can offer partial support for study towards a PhD, an MSc, or a Postgraduate Diploma. Between 2005 and 2010, 213 of these scholarships have been awarded. From 2009 support

by the International Mathematical Union has enabled this scheme to continue, and there will soon be an announcement for the 2010/11 Scholarships.

There have been four AMMSI Regional Conferences and two African Scientific meetings. Every year the London Mathematical Society provides support for postgraduate students to attend conferences.

The AMMSI network also manages the African calls for proposals under the MARM scheme.

AMMSI is proud to have enabled staff and institutions in different continents to collaborate, to have provided opportunities for younger researchers to participate in conferences, and to have enabled staff and postgraduate students to write and publish papers. However, we need to address concerns over funding constraints, the transfer of funds to awardees, the promotion of research, and enhanced outreach activities.

For more information visit:

<http://www.ammsi.org>

4. MARM in Ghana

Frank Neumann described his experience of research mentoring and collaboration with the Department of Mathematics, Kwame Nkrumah University of Science and Technology (KNUST), Kumasi, Ghana.

The Department of Mathematics at KNUST has 25 academic staff and currently 750 undergraduate and 40 postgraduate students. The research areas can be divided as follows: Pure Mathematics, Applied Mathematics, Computational Mathematics, Operations Research, Statistics and Probability, Financial Mathematics, and Actuarial Science.

The activities and achievements of this partnership include:

- Lecture series on “Algebraic Topology and its Applications” by the mentor (10 lectures)
- Mentoring and co-supervision of three postgraduate students (MSc, PhD) which included several mutual visits by the mentor and his African colleagues.
- Improvement of local research environment, by demonstration of free online resources (arxiv, Hopf Archive, and so on), by participation in the “e-math for Africa” scheme, and by the provision of mathematical textbooks and volumes of journals
- Establishment of a new research and training centre at KNUST, the National Institute of Mathematical Sciences (NIMS), whose current Director is Isaac Dontwi, the MARM collaborator at KNUST. This is partially funded by the Government of Ghana, and the MARM project played a

crucial role in the choice of KNUST to host this new centre. Research activities and workshops partially funded by MARM and organised through NIMS include two workshops on Modelling Complex Systems in 2008, an International Conference on “Mathematics and its Applications” at the University of Ghana, Accra, in 2009, and a Summer Class on Homology at the University of Ghana, Accra in 2010 given by Dror Bar-Natan (Toronto).

- The Department of Mathematics and the National Institute for Mathematical Sciences (NIMS) at KNUST expect to establish links with the African Institute of Mathematical Sciences (AIMS) in Muizenberg, South Africa.

5. MARM at the University of Buea

Felix Shu described the work of the MARM partnership between the mentor, Sergey Foss, and the University of Buea, Cameroon, starting by explaining the extreme shortage of qualified staff:

Subject	Post	Number
Algebra	Professor	0
	Associate Professor	1
	Lecturer	0
	Assistant Lecturer	1 (a PhD student)
Analysis	Professor	0
	Associate Professor	0
	Lecturer	1
	Assistant Lecturer	1 (a PhD student)
Mathematical Analysis	Professor	0
	Associate Professor	0
	Lecturer	1
	Assistant Lecturer	1 (a PhD student)
Mathematical Biology	Professor	0
	Associate Professor	1
	Lecturer	0
	Assistant Lecturer	0
Probability	Professor	0
	Associate Professor	0
	Lecturer	1
	Assistant Lecturer	1 (a PhD student)

The extremely high workload faced by staff who are in some cases also studying for their PhDs was a point reinforced by a comment from the audience later in the discussion.

In 2010 there are eight students working for an MSc or PhD, but of the four students who started the MSc in 2008, three left the country to study elsewhere without getting to the end of the programme.

Felix went on to note the achievements within the MARM framework, which include:

- two mentoring visits from Edinburgh to Buea,
- purchase of text books and journals for the Departmental Library,
- one course taught by the mentor in 2007 at Buea,
- participation of the mentor in mathematics syllabus review in 2007 at Buea,
- a research visit from Buea to Edinburgh in 2008,
- one paper published with collaboration of the mentor, and
- agreement to supervise two students in probability.

Further research collaboration and co-supervision of a PhD student is continuing, and there are plans for more visits between Edinburgh and Buea. Felix finished his presentation by making some suggestions for improvements in the scheme, such as:

- simplifying the mechanisms for the transfer of funds,
- increasing the duration of each project,
- encouraging cooperation and communication between students of the mentoring and mentored Departments, and
- making some funds available to encourage postgraduate students of the mentored University not to leave.

6. ICTP

Ramadas Ramakrishnan gave a brief account of the work of the International Centre for Theoretical Physics, which turns 45 this year. Since its inception, over 100,000 scientists have visited the Centre, around half from developing countries.

The funding of the centre comes from a tripartite agreement between the Italian Government, the IAEA, and UNESCO. There are about 32 permanent staff, of which four are in the mathematics section.

The Office of External Activities of the ICTP supports several networks and affiliated centres around the world, as well as initiatives like a PhD programme for sub-Saharan Africa and a series of schools in East Africa.

The format of the intensive activities organised by ICTP is that of school + conference. In 2010 there were four of these at ICTP, with a fifth one to be held in Libya. In 2011 there will be three again at ICTP and three “external” ones, amongst which two are co-funded with CIMPA.

In 2009 there were 114 visitors from 47 countries, involving 32 seminars, and 32 publications. Also, among the 500 or so Associates of ICTP, over 100 are mathematicians.

The Centre is involved in the award of the Ramanujan Prize, and among other things it runs a book donation program. It also has a Diploma scheme, and awards about ten each year.

In future the ICTP would like to continue to be involved in collaborative programs, for example with CIMPA, and perhaps also with national or regional bodies. There are clear opportunities for coordination with MARM and other initiatives, and ICTP would also like to set up a “research in groups” scheme in Trieste.

Ramadas ended his presentation by reminding delegates of the original mission of ICTP, which is to support researchers (who often work in difficult circumstances) where viable communities exist, and to help seed such communities where possible.

7. IMU Volunteer Lecturer Programme

Angel Pineda explained that the VLP was established by the Developing Countries Strategy Group of the International Mathematical Union, inspired by the Centre International de Mathématiques Pures et Appliquées program at the Royal University of Phnom Penh (RUPP), the London Mathematical Society’s Mentoring African Research in Mathematics program, and the Norwegian Program for Development, Research and Education in southern Africa.

The VLP will be administered by the newly created IMU Commission for Developing Countries.

Its collaborators are:

- International Mathematical Union
- US National Committee for Mathematics
- Centre International de Mathématiques Pures et Appliquées
- London Mathematical Society

It receives financial support from:

- French Government
- US National Science Foundation
- American Mathematical Society

- Society of Industrial and Applied Mathematics
- London Mathematical Society

In this scheme a Visiting Lecturer gives a three or four week intensive course at the upper undergraduate or master's level, to a substantial number of students (meaning about twenty). The local host provides support for the recruitment of students, and the scheduling and living arrangements for the volunteer, but all financial costs of the volunteer are covered by the VLP.

The scheme focuses on facilitating the transition between an undergraduate and a graduate level understanding of mathematics. In terms of mathematical development, it is designed to help a country build the mathematical foundations necessary for subsequent research level mathematics.

Angel then made some brief remarks on his teaching experience at the Royal University of Phnom Penh. He taught numerical analysis on two occasions, in 2009 and 2010. The courses were for three hours a day, five days a week. The challenges faced were:

- teaching at the appropriate level
- language barrier
- time
- cultural differences
- access to technology

Strategies for addressing each of these challenges were discussed.

Looking back, the enthusiasm and appreciation of the students was fantastic, and it was exciting to be part of a critical time in the mathematical development of Cambodia, and to make a difference.

More information about volunteering or hosting lecturers through the VLP can be found at:

www.math.ohio-state.edu/~imu.cdc/vlp/

The IMU VLP is actively seeking more hosts from the developing world as well as volunteer lecturers.

More information about this experience teaching at RUPP can be found in the article: "Teaching Numerical Analysis in Cambodia", SIAM News, March 2010.

8. Contributions from the floor

8.1. Michel Passare. Michel informed the meeting of a new agreement between Stockholm University and the University of Dar es Salaam to establish a pan-African graduate school in mathematics. He said that there were many ways in which the community could help, not least in making suggestions for a Director of the graduate school.

8.2. Michel Waldschmidt. (a) The International Center for Pure and Applied Mathematics (CIMPA) is another organisation providing mechanisms for strengthening mathematics in developing countries. It has organized 180 research schools in the last 30 years, with 14 planned for 2011. There are open calls every year. In addition, CIMPA also promotes regional networks, organizes workshops and seminars, has links with other institutions like AMU, UMALCA, SEAMS, and ICTP.

Recently, a memorandum of understanding was signed between CIMPA and the Spanish Ministerio de Ciencia e Innovacion, providing for Spanish funding for CIMPA in addition to its existing funding from the French Government. It is hoped to have more similar agreements in the near future.

More information about CIMPA can be found at:

<http://www.cimpa-icpam.org/>

(b) The Committee for the Developing Countries (CDC) of the European Mathematical Society also works in this field. Its first action was to help disseminate mathematical literature with a book donation program. Now the scope is much larger. The IMU provides support which enables the CDC to organize workshops in Africa on access to electronic literature. Also, Zentralblatt has agreed to give free access to libraries of mathematics departments in developing countries.

Another initiative of the CDC is a twinning program: the committee offers small seed grants to help departments in developed and developing countries twin with each other. Finally, a further plan of this committee is to identify Emerging Regional Centres of Excellence (ERCE) which could play a leading role in the region for the development of mathematics at research level.

8.3. José-Antonio de la Peña. As the newly-elected President of the IMU Commission for Developing Countries, José-Antonio expressed his strong support for these various projects. He noted that In Latin America there is an extremely successful programme of research schools, attracting large numbers of students from all over the region.

8.4. John Mango. John spoke on the great benefit his University, Makerere University, Kampala, Uganda, had derived from the MARM scheme, especially in algebra. In this case the mentor is Gregory Sankaran from the University of Bath. It is also hoped to make use of the VLP.

8.5. Hamidou Touré. Hamidou is the AMMSI Regional Coordinator, from the Université de Ouagadougou, Burkina Faso. He pointed out that:

(a) there is very wide variation in the particular needs of developing countries, and

(b) networking is extremely important among research mathematicians.

9. Concluding Remarks

The President of the LMS, Angus Macintyre, invited those who had not had a chance to speak to write to President@lms.ac.uk

He thanked all the panellists and organizers, and expressed the hope that there would be similar such discussion meetings in future.

Other Activities

The IMU sponsored two public lectures during the Congress. These were held at the Global Peace Auditorium in Hyderabad. The speakers were

Bill Barton (Auckland)

Where is Mathematics taking us,

and

Günter Ziegler (Berlin)

Proofs from the book.

The lectures drew a large audience of about 1500 school and college students. The speakers described it as an unusual and overwhelming experience.

There was a *Mandelbrot Fractal Art Exhibition* in the lobby of the second floor of the Congress venue, where twenty five prize winning designs were exhibited. On the first floor there was an exhibition of photographs from the IHES, Paris. Several publishers displayed their books in a large hall on the ground floor.

There was a program of classical dance *Bharatanatyam*. The performance of the ballet *Panchamahabhutam* was led by Professor C. V. Chandrasekhar. It was produced by Nrityashree of Chennai.

Ustad Rashid Khan, a famous Hindustani classical singer, gave a concert. It being the monsoon season he chose to sing the *Malhar* raga, associated with the rains. To prepare the audience, the Organising Committee organised two lectures on appreciation of Indian classical music by Professor Sunil Mukhi.

A video recording of the dance ballet *Lilavati* by the famous dancer Chandralekha was shown a few times in one of the halls.

The theatre company Complicite of London gave two performances of their play *A Disappearing Number* at the Global Peace Auditorium. These were open to the public.

Grandmaster Viswanathan Anand, World Chess Champion, played simultaneous chess matches with forty opponents. He beat 39 of them. The 14 years old Srikar Varadaraj managed a draw.

Springer India brought out a handsomely produced *Hyderabad Intelligencer* edited by S. G. Dani. The Ramanujan Mathematical Society brought out a special issue of its Newsletter edited by S. Ponnusamy.

The Publications Committee produced a special colour booklet with short pieces on mathematics, Indian history, art, music and culture. It has two pockets to house the CD version of these Proceedings.

List of Participants

Abate, Marco (Italy)
Abbas, Sayed Mohammad (India)
Abbas, Zaheer (India)
Abdollahi, Alireza (Iran)
Abdounur, Oscar Joao (Brazil)
Abdul Najath, M. P. (India)
Abhinav, Kumar (India)
Abimanyu, Purusothaman (India)
Abraham, Joseph (India)
Abrahamian, Roberto M. (Uruguay)
Achar, Pramod Narahari (USA)
Acharyya, Sudip Kumar (India)
Adeniran, Tinuoye Michael (Nigeria)
Adepoju, Jerome Ajayi (Nigeria)
Adersh, V. K. (India)
Adhav, Kishor (India)
Adler, Jillian Beryl (South Africa)
Afrooz, Susan (Iran)
Afsar, Mohammed Zamir (USA)
Agarwal, Arihant (India)
Agarwal, Mahesh Kumar (USA)
Agarwal, Mukul (USA)
Agarwal, Suresh Kumar (India)
Agarwal, Vinay (India)
Agarwala, Susama (USA)
Agdeppa, Rhoda Padua (Philippines)
Aggarwal, Aekta (India)
Agrawal, Mamta (India)
Agrawal, Purshottam (India)
Agrawal, Rashmi (India)
Ahanjideh, Neda (Iran)
Aharonov, Dorit (Israel)
Ahmad, Khan Faizan (India)
Ahmad, Reyaz (United Arab Emirates)
Ahmed, Osman Elnubi (Sudan)
Ahmed, Nazibuddin (India)
Ahmed, Shakeel (India)
Ahmed, Suman (India)
Ahn, Jiweon (Rep. Korea)
Ahn, So Young (Rep. Korea)
Ahuja, Anuradha (India)
Ahuja, Om P. (USA)
Aiba, Akira (Japan)
Aissa, Guesmia (France)
Aithal, A. R. (India)
Aithal, Vikram (India)
Akhilesh, P. (India)
Aldous, David John (USA)
Ale, Samson O (Nigeria)
Aledo, Juan A. (Spain)
Aleksandrov, Alexander (Russian Federation)
Alexander, Sukhotin (Russian Federation)
Alexandra, Tkacenko (Moldova)
Alexeev, Boris (USA)
Ali, Faryad (Pakistan)
Ali, Javid (India)
Ali, Muhamed Syed (India)
Ali, Shakir (India)
Ali, Syed Ahmad (India)
Aliabad, Ali Rezaei (Iran)
Alla, Baburao (India)
Allu, Vasudevarao (India)
Almeida, João Paulo Pais De (Portugal)
Alodan, Haila Mohd (Saudi Arabia)
Alonso, David (Spain)
Alrashed, Maryam (Kuwait)
Aluffi, Paolo (USA)
Alves, Maicon Marques (Brazil)
Alves, Manuel Joaquim (Mozambique)
Amaranath, Tirumalasetty (India)
Ambika, P. (India)
Ambily, A. A. (India)
Amirali, Gabil (Turkey)
Ammi, Moulay Rchid Sidi (Morocco)
Amrutiya, Sanjaykumar Hansraj (India)
Anand, Ankit (India)
Anand, Bijo S. (India)
Anandam, Victor I. (India)
Anandavardhanan, U. K. (India)
Ananthakrishna, Gururaja (India)
Anantharaman, Nalini Florence (France)
Anbareeswaran, Sairam Kaliraj (India)
Anbhu, Swaminathan (India)
Ancel, Esther (USA)
Andersson, Johan Fredrik (Sweden)
Andharia, Paresh (India)
Andrada, Adrian Marcelo (Argentina)
Andrade, Jorge Antonio Soto (Chile)
Andreatta, Marco (Italy)
Andrews, George W. Eyre (USA)

- Andrist, Rafael Benedikt (Switzerland)
 Andrzej, Wrzesien (Poland)
 Anguraj, Annamalai (India)
 Anh, Ngoc Pham Huu (Vietnam)
 Anil, M. (India)
 Anoop, T. V. (India)
 Ansari, Abu Zaid (India)
 Ansari, Qamrul Hasan (India)
 Antony, P. L. (India)
 Antonyan, Sergey (Mexico)
 Anusha, (India)
 Anusha, A. K. (India)
 Anwari, Rahemani Sk. Ibrahim (India)
 Anzuetto, William Adolfo P. (Guatemala)
 Aparna Lakshmanan, S. (India)
 Apaza, Carlos Alberto Maquera (Brazil)
 Apte, Amit (India)
 Arai, Jin (Japan)
 Araki, Fujihiro (Huzihiro) (Japan)
 Arasamudi, Ramesh Babu (India)
 Arasi, S. Kalai (India)
 Araujo, Carolina (Brazil)
 Aravamuthan, Sarang (India)
 Arceo, Carlene Perpetua P. (Philippines)
 Archana, Margam (India)
 Argerami, Martin (Canada)
 Arjunan, Mani Mallika (India)
 Armel, Jonathan Joshua (USA)
 Arnold, Douglas Norman (USA)
 Arockiam, Lourdusamy (India)
 Arockiasamy, Antony (India)
 Arora, Anu (India)
 Arora, Ashish (India)
 Arora, Dimpal (India)
 Arora, Geeta (India)
 Arós, Ángel Daniel Rodríguez (Spain)
 Arshad, Khan (India)
 Arshad, Mohd (India)
 Artacho, Francisco Javier Aragon (Spain)
 Artamonov, Nikita (Russian Federation)
 Arthur, James Greig (Canada)
 Arumugasamy, Chandrashekar (India)
 Arunachalam, Puduru V. (India)
 Arunkumar, M. (India)
 Aryampilly, Parameswaran (India)
 Aryampillymana, Jayanthan (India)
 Asaoka, Masayuki (Japan)
 Ash, J. Marshall (USA)
 Asharaf, Noufal (India)
 Ashraf, Mohammad (India)
 Ashraf, Wajih (India)
 Asif, Mohammad (India)
 Asma, Ali (India)
 Asok, Aravind (USA)
 Asopa, Khushboo (India)
 Assal, Miloud (Tunisia)
 Astashova, Irina (Russian Federation)
 Astley, Roger Stephen (U.K.)
 Atreya, Shweta (India)
 Auel, Asher Natan (USA)
 Aujla, Jaspal Singh (India)
 Auroux, Denis Sylvain (USA)
 Avadayappan, Selvam A. (India)
 Avalishvili, Gia (Georgia)
 Avdispahic, Muharem (Bosnia and Herzegovina)
 Avila, Artur (Brazil)
 Avritzer, Dan (Brazil)
 Awanou, Gerard (USA)
 Awasthi, Mukesh Kumar (India)
 Ayuby, Salahuddin (India)
 Azarpanah, Fariborz (Iran)
 Azeef Muhammed, P. A. (India)
 Aznar, Vicente Navarro (Spain)
 Azrou, Nadia (Algeria)
 Baake, Ellen (Germany)
 Babu, Avula Banerji (India)
 Babu, Gutti Venkata R. (India)
 Babu, Lingampalli Ravindranath (India)
 Babu, Sukumaaran (India)
 Baek, Hunki (Rep. Korea)
 Baer, Christian (Germany)
 Bagayogo, A. Bass (Germany)
 Bagchi, Atish (USA)
 Bagchi, Satya (India)
 Bagchi, Somesh (India)
 Bagci, Irfan (USA)
 Bagga, Raji K. (India)
 Bagheri, Mohammad (Iran)
 Baiculescu, Sorin (Romania)
 Bairagi, Nandadulal (India)
 Baird, Thomas John (Canada)
 Bajaj, Rakesh Kumar (India)
 Bajaj, Renu (India)
 Baji Babu, B. (India)
 Bajpai, Saumya (India)
 Baker, Abdullah Bin Abu (India)
 Bakuli, Abhishek (India)
 Bal, Hartosh (India)
 Balaji, Sundeep (USA)
 Balakrishnan, Ramakrishnan (India)
 Balaram, Bipin (India)
 Balashchenko, Vitaly (Belarus)
 Balasubramanian, Ramachandran (India)
 Balasubramanian, Srinivasa (India)
 Balderrama, Cristina (Venezuela)
 Ball, John (U.K.)
 Balleier, Carsten (Germany)
 Balmaceda, Jose Maria P. (Philippines)
 Balmer, Paul (USA)

- Bambah, Bindu (India)
Bambah, Ram Prakash (India)
Bamigbola, Olabode Matthias (Nigeria)
Bandara, Menaka Lashitha (Australia)
Bandaru, Radha Krishna (India)
Bandhopadhyaya, Subhodeep (India)
Bandyopadhyay, Antar (India)
Bandyopadhyay, Arghya (India)
Bandyopadhyay, Pradipta (India)
Banerjee, Debargha (India)
Banerjee, Kuntal (India)
Banerjee, Snigdha (India)
Bang, Sejeong (Rep. Korea)
Bankuti, Ilona Gyöngyi (Hungary)
Bano, Ambreen (India)
Bansali, Priyanka Manikchand (India)
Baoulina, Ioulia (India)
Bapat, Ravindra Bhalchandra (India)
Bapna, Indu Bala (India)
Bardina, Xavier (Spain)
Barik, Pabitra (India)
Barik, Sasmita (India)
Barman, Kishor Kumar (India)
Barman, Rupam (India)
Barnwal, Amit Kumar (India)
Barrallo, Javier (Spain)
Barrett, David Eugene (USA)
Barton, William David (New Zealand)
Bartosiewicz, Zbigniew Jan (Poland)
Bartoszynski, Tomek (USA)
Barua, Rana (India)
Basak, Anirban (India)
Baskoro, Edy Tri (Indonesia)
Basu, Prabahan (India)
Basu, Rakhee (India)
Basu, Riddhipratim (India)
Basu, Suratno (India)
Batra, Punita (India)
Bazhenov, Mikhail (Russia)
Bazzoni, Giovanni (Spain)
Beaumont, Eleanor Naomi (India)
Bedaride, Nicolas (France)
Beg, Mirza Iftekhar (India)
Behera, Biswaranjan (India)
Behera, Namita (India)
Behforooz, Hossein (USA)
Behrends, Ehrhard (Germany)
Belkale, Prakash (USA)
Bellaiche, Joel (USA)
Bellarykar, Nikhil (India)
Bellingham, John (Australia)
Bellos, Alex (U.K.)
Belmiloudi, Aziz (France)
Benevides, Fabricio Siqueira (USA)
Benjamini, Itai (Israel)
Benson, David John (U.K.)
Bera, Sayani (India)
Berg, Christian (Denmark)
Bergner, Julia Elizabeth (USA)
Bernard, Patrick (France)
Bernatska, Julia (Ukraine)
Bertone, Ana Maria (Brazil)
Bessa, Gregorio Pacelli Feitosa (Brazil)
Betancur, Jorge Ivan Cossio (Colombia)
Bhadraman, Tuladhar (Nepal)
Bhagat, Amita (India)
Bhagwat, Chandrasheel Rajendra (India)
Bhakta, Mousomi (India)
Bhambri, Sudarshan Kumar (India)
Bhanu, K. S. (India)
Bharadwaj, B. V. K. (India)
Bharali, Gautam (India)
Bharatha, Kiran Kumar (India)
Bhargava, Srinivasamurthy (India)
Bhaskara, Adithya (India)
Bhasker (India)
Bhat, B. V. Rajarama (India)
Bhat, Sanjay Purushottam (India)
Bhat, Vijay Kumar (India)
Bhat, S. Ravi Shankar (India)
Bhate, Hemant (India)
Bhatia, Rajendra (India)
Bhatia, Sumit Kaur (India)
Bhatnagar, Savita (India)
Bhatt, Abhay (India)
Bhatt, Gaurav (India)
Bhatt, Sandeep (India)
Bhatt, Subhash (India)
Bhatta, Chet Raj (Nepal)
Bhattacharjee, Monojit (India)
Bhattacharya, Atreyee (India)
Bhattacharya, Shalini (India)
Bhattacharya, Shouvik (India)
Bhattacharya, Soumya (Germany)
Bhattacharyya, Arindam (India)
Bhattacharyya, Joydeb (India)
Bhattacharyya, Rabindra Kumar (India)
Bhattacharyya, Rupak (India)
Bhattacharyya, Tirthankar (India)
Bhavanari, Satyanarayana (India)
Bhavaraju, Sri Padmavati (India)
Bhimasankaram, P. (India)
Bhoosnurmath, Subhas (India)
Bhowmik, Bappaditya (India)
Bhowmik, Gautami (France)
Bhunia, Asoke Kumar (India)
Bhupal, Mohan Lal (Turkey)
Bhusal, Tikaram (Nepal)
Bhuvaneswari, Rengaraj (India)
Biegler-König, Friedrich (Germany)
Bierstone, Edward (Canada)
Biju, K. (India)

- Bikram, Panchugopal (India)
 Billera, Louis Joseph (USA)
 Birajdar, Guntant (India)
 Bishnoi, Anuj (India)
 Bisht, Amit (India)
 Bisht, Chandan Singh (India)
 Bisht, Praveen Singh (India)
 Bisht, Shilpi (India)
 Biswas, Animesh (India)
 Biswas, Anup (India)
 Biswas, Jishnu Gupta (India)
 Biswas, Kingshook (India)
 Biswas, Mrinmay (India)
 Biswas, Sazzad (India)
 Biswas, Shibhananda (India)
 Bitragunta, Sainath (India)
 Bobbala, Manogna (India)
 Bocea, Marian (USA)
 Bokayev, Nurzhan (Kazakhstan)
 Bokil, Vrushali Avinash (USA)
 Bokka, Surender Reddy (India)
 Bolt, Michael David (USA)
 Bommanahal, Basavanagoud (India)
 Bondecka-Krzykowska, Izabela (Poland)
 Bont, Petronella W. De (Netherlands)
 Boobalan, Jayaraman (India)
 Booss, Bernhelm (Denmark)
 Boppana, Shobha (India)
 Bora, Swaroop Nandan (India)
 Borah, Diganta (India)
 Borgato, Maria Teresa (Italy)
 Boris, Chetverushkin (Russian Federation)
 Borisagar, Gautam (India)
 Borkar, Vivek (India)
 Borodin, Alexei (USA)
 Borse, Yashwant Manikrao (India)
 Bose, Arindam (India)
 Bose, Arup (India)
 Bose, Debashish (India)
 Bose, Sujit Kumar (India)
 Böttcher, Roger (Germany)
 Bourguignon, Jean-Pierre A. (France)
 Boya, Luis Joaquín (Spain)
 Bozicevic, Mladen (Croatia)
 Brandao, Daniel Smania (Brazil)
 Breuil, Christophe Olivier (France)
 Brooke-Taylor, Andrew David (U.K.)
 Brothier, Arnaud (France)
 Brotons, Alma Luisa Albuja (Spain)
 Broughan, Kevin Alfred (New Zealand)
 Brown, Aldric Loughman (U.K.)
 Brown, Kenneth Alexander (U.K.)
 Browne, Brendan Thomas (Ireland)
 Browning, Timothy (U.K.)
 Brüning, Erwin A. K. (South Africa)
 Bruyn, Bart José H. Céran De (Belgium)
 Bryant, Robert Leamon (USA)
 Brzezniak, Zdzislaw (U.K.)
 Bucur, Alina Ioana (USA)
 Buddhavarapu, Alekhya (India)
 Buddhi, Kota Subbarao (India)
 Budur, Nero (USA)
 Buergisser, Peter (Germany)
 Buff, Xavier (France)
 Buhphang, Ardeline Mary (India)
 Buitrago, Antonia Redondo (Spain)
 Bujalance, Emilio (Spain)
 Bujurke, Nagendrappa (India)
 Burenkov, Victor (Kazakhstan)
 Burq, Nicolas (France)
 Burstein, Richard David (USA)
 Buruju, Surendranath Reddy (India)
 Burungale, Ashay (USA)
 Bushaw, Neal (USA)
 Bykov, Dmitry (Ireland)
 Byrne, Catriona (Germany)
 Cabarcas, Jaime Alfonso A. (Colombia)
 Calkins, Nancy Diane (USA)
 Camacho, Jaime Ignacio L. (Colombia)
 Campillo, Antonio (Spain)
 Campos, Magdalena Caballero (Spain)
 Campos, Rafael Gonzalez (Mexico)
 Cañadas, Agustín Moreno (Colombia)
 Cao, Huaixin (China)
 Cara, Enrique Fernandez (Spain)
 Carbery, Anthony Patrick (U.K.)
 Carlos, Nicanor Ramos (Mexico)
 Carrillo, Maria Inmaculada G. (Spain)
 Casacuberta, Carles (Spain)
 Casselman, William Allen (Canada)
 Cassy, Bhangy (Mozambique)
 Castelino, Lolita (India)
 Cavalcante, Marcos Petrúcio (Brazil)
 Celaya, Elisabete Alberdi (Spain)
 Celeste, Richell (Philippines)
 Cellarosi, Francesco (USA)
 Cendra, Hernán (Argentina)
 Cerejeiras, Paula Cristina (Portugal)
 Chacko, V. M. (India)
 Chacón, Mónica Del P. C. (Germany)
 Chaichiraghimi, Mohammad (Iran)
 Chaitanya, Krishna (India)
 Chaitanya, Y. N. V. Krishna (India)
 Chakicherla, Sandhya (India)
 Chakrabarti, Alok Nath (India)
 Chakraborty, Debopam (India)
 Chakraborty, Partha Sarathi (India)
 Chakraborty, Sagnik (India)
 Challa, Subrahmanya (India)
 Chand, Arya Kumar (India)

- Chander, Trilok (India)
Chandra, Harish (India)
Chandra, Peeyush (India)
Chandramouli, V. V. M. Sarma (India)
Chandrasekar, V. (India)
Chandrasekaran, Uma Maheswari (India)
Chandrashekar, Adiga (India)
Chandravel, P. S. (India)
Chang, Kun Soo (Rep. Korea)
Changat, Manoj (India)
Charak, Kuldeep Singh (India)
Chatterjee, Anal (India)
Chatterjee, Pralay (India)
Chatterjee, Subhamoy (India)
Chatterjee, Tapas (India)
Chatterji, Indira (India)
Chatterji, Srishti Dhar (Switzerland)
Chattopadhyay, Arup (India)
Chattopadhyay, Kshitis Chandra (India)
Chattopadhyay, Pratyusha (India)
Chattopadhyay, Sumanta (India)
Chattopadhyay, Surajit (India)
Chattopadhyay, Utpal (India)
Chaubey, Sneha (India)
Chaudhari, Narendra Shivaji (India)
Chaudhary, Pratibha Jagannath (India)
Chaudhuri, Arindam (India)
Chaudhuri, Chitrabhanu (USA)
Chaudhuri, Kripasindhu (India)
Chaudhuri, Probal (India)
Chauhan, Archana (India)
Che, Shu Felix (Cameroon)
Chellaboina, Vijaya Sekhar (India)
Chelvam, Thirugnanam Tamizh (India)
Chemin, Jean-Yves Marie (France)
Chen, Deliang (France)
Chen, Guang (China)
Chen, Linda (USA)
Chen, Louis Hsiao Yun (Singapore)
Chen, Min-Hung (Taiwan)
Chen, Peide (China)
Chen, Qingtao (USA)
Chen, Shuxing (China)
Chen, Yonggao (China)
Chen, Zhen-Qing (USA)
Cheng, Chong-Qing (China)
Cheng, Jian (China)
Cheng, Wei (China)
Cheraku, Narasimha Kumar (India)
Cherikuri, Venkata Aditya (India)
Chérítat, Arnaud Roland Paul (France)
Chetry, Moon K (India)
Chiang, Tzuu-Shuh (Taiwan)
Chiang, Yuan-Jen (USA)
Chien, Mao-Ting (Taiwan)
Chinta, Gautam (USA)
Chintala, Vineeth (India)
Chintamani, Mohan (India)
Chintapalli, Seshadri (India)
Chiranjeevi, Perikala (India)
Chitkara, Ashok Kumar (India)
Chitra, V. (India)
Cho, Bumkyu (Rep. Korea)
Cho, Cheol Hyun (Rep. Korea)
Cho, Sung Je (Rep. Korea)
Choe, Boo Rim (Rep. Korea)
Choi, Hee Yeun (Rep. Korea)
Choi, Hyung Sup (USA)
Choi, In Sun (Rep. Korea)
Choi, Q-Heung (Rep. Korea)
Choi, Seunghoe (Rep. Korea)
Choi, Taeyoung (Rep. Korea)
Choi, Youngook (Rep. Korea)
Choi, Yun Sung (Rep. Korea)
Chong, Chi Tat (Singapore)
Chopra, Garima (India)
Chorwadwala, Anisa Mohmad H. (India)
Choudhuri, Debajoyti (India)
Choudhury, Amit (India)
Choudhury, Rita (India)
Chowdaiah, Kunda (India)
Chowdhury, Khanindra (India)
Chowdhury, Shirshendu (India)
Chu, May (USA)
Chutia, Chandra (India)
Clop, Albert (Spain)
Clozel, Laurent Yves (France)
Coates, John Henry (U.K.)
Cockburn, Julio Bernardo (USA)
Cohn, Donald Lee (USA)
Cohn, Henry (USA)
Colina, Mairene (Venezuela)
Colmez, Pierre (France)
Comman, Henri (Chile)
Connell, Chris (USA)
Contreras, Gonzalo (Mexico)
Contreras, Roy Omar Q. (Venezuela)
Coron, Jean-Michel (France)
Corona, Adriana R. Suárez (Spain)
Coskunuzer, Baris (Turkey)
Costello, Kevin Joseph (USA)
Cota, Aldo Hilario Cruz (USA)
Cowsik, Ramakrishna C. (India)
Cruz, Sergio Jesús García (Mexico)
Csikvári, Peter (Hungary)
Csóka, Endre (Hungary)
Csörnyei, Marianna (U.K.)
Cuadrado, Silvia (Spain)
Cuminato, José Alberto (Brazil)
Cuong, Nguyen Tu (Vietnam)
Curbera, Guillermo (Spain)
Curran, Stephen Robert (USA)

- Dabhi, Prakash (India)
 Daenzer, Calder Weston Daedalus (USA)
 Dahiya, Daisy (India)
 Dahmen, Wolfgang Anton (Germany)
 Dai, Lixia (China)
 Dalal, Durga Charan (India)
 Dalang, Robert Charles (Switzerland)
 Dalawat, Chandan Singh (India)
 Dalen, Benno Van (Germany)
 Dales, Harold Garth (U.K.)
 Dalitz, Wolfgang (Germany)
 Dalvi, Kiran (India)
 Dalyan, Elif (Turkey)
 Damle, Vaishali (USA)
 Dan, Krishanu (India)
 Dancer, Edward (Australia)
 Dancer, Karen Ann (Australia)
 Dani, Pallavi (USA)
 Dani, Shrikrishna Gopalrao (India)
 Daniel, Sukumar (India)
 Dara, V. V. P. R. V. B. Suresh (India)
 Darafsheh, Mohammad Reza (Iran)
 Darkunde, Nitin Shridhar (India)
 Darwish, Mohamed Abdalla (Egypt)
 Das, Ananga Kumar (India)
 Das, Angsuman (India)
 Das, Ashish Kumar (India)
 Das, Ashok Kumar (India)
 Das, Jyoti (India)
 Das, Kajal (India)
 Das, Kalyan (India)
 Das, Krishnendu (India)
 Das, Manoj Kumar (India)
 Das, Nanda Ram (India)
 Das, Pratibhamoy (India)
 Das, Pratulananda (India)
 Das, Prohelika (India)
 Das, Prosenjit (India)
 Das, Raman Kumar (India)
 Das, Saikat (India)
 Das, Sankar Kumar (India)
 Das, Sayan (India)
 Das, Shubhabrata (India)
 Das, Shyam Sumanta (India)
 Das, Sumita (India)
 Das, Tarun (India)
 Dasgupta, Abhishek (India)
 Dasgupta, Aparajita (India)
 Dasgupta, Arnab Jyoti (India)
 Dasgupta, Nikhilesh (India)
 Dash, Saroj Kumar (India)
 Dass, Bal Kishan (India)
 Dass, Tulsi (India)
 Dasu, Krishna Kiran Vamsi (India)
 Datchev, Kiril (USA)
 Datta, Ahana (India)
 Datta, Basudeb (India)
 Datta, Dhurjati Prasad (India)
 Datta, Mahuya (India)
 Datta, Sudip (India)
 Daubechies, Ingrid (USA)
 David, Sinnou Gilbert (France)
 Dayal, Mohit (India)
 D'Cruz, Clare (India)
 D'Cunha, Ratika N. (India)
 De, Prithwijit (India)
 De, Uday Chand (India)
 Deb, Biswajit (India)
 Debinska-Nagorska, A. Maria (Poland)
 Debnath, Joyati (USA)
 Debnath, Srabani (India)
 Debnath, Ujjal (India)
 Dedania, Hareshkumar (India)
 Deepak, P. (India)
 Deepti, (India)
 Degla, Guy Aymard (Benin)
 Deka, Rudra Kanta (India)
 Delabriere, Marie-Claude C. (France)
 Delbaen, Freddy Eduard (Switzerland)
 Deldar, Forough (Iran)
 Delgado, Isabel Fernandez (Spain)
 Dem, Himani (India)
 Demidenko, Gennadii (Russian Federation)
 Dencker, Nils Jonas (Sweden)
 Deniz, Asli (Denmark)
 Deo, Satya (India)
 Deore, Rajendra (India)
 Desai, Ajay (India)
 Desfitri, Rita (Indonesia)
 Deshmukh, Sharief (Saudi Arabia)
 Deshouillers, Jean-Marc (France)
 Deshpande, Amit Jayant (India)
 Deshpande, Atul Bhaskar (India)
 Deshpande, Charusheela (India)
 Deshpande, Rupali Sadashiv (India)
 Desquith, Etienne (Ivory Coast)
 Deszynski, Krzysztof (Poland)
 Devakar, Masabathula (India)
 Devarsu, Radha Pyari (India)
 Devi, Chandra Sekar Prasanna (India)
 Devi, Nirupama (India)
 Devi, Okram Ratnabala (India)
 Devi, Sanjrambam (India)
 Dewan, Kum Kum (India)
 Dewan, Shyamali (India)
 Dey, Arabin Kumar (India)
 Dey, Debika (India)
 Dey, Lakshmi Kanta (India)
 Dey, Rukmini (India)
 Dey, Sanjib (India)
 Dey, Soumya (India)

- Dey, Suparna (India)
Dhaigude, Dnyanoba Bhaurao (India)
Dhakne, Machindra Baburao (India)
Dhandhukiya, Satya (India)
Dhankhar, Namita (India)
Dhanya, M. (India)
Dhara, Anulekha (India)
Dharan, Sophiya S. (India)
Dhariwal, Gaurav (India)
Dharmadhikari, Avinash (India)
Dhawan, Sharanjeet (India)
Dias, Luiz Gustavo Farah (Brazil)
Dias, Sigmilla (India)
Diaz, Aldo Abraham Garcia (Mexico)
Diaz, Rafael (Colombia)
Diaz, Viviana Alejandra (Argentina)
Diblík, Josef (Czech Republic)
Dickenstein, Alicia (Argentina)
Didimos, K. V. (India)
Dikshit, Hanuman P. (India)
Dikshit, Sunanda (New Zealand)
Dilip, D. S. (India)
Dilshad, Mohammad (India)
Dimitrov, Mladen (France)
Dimri, Ramesh Chandra (India)
Dinar, Yassir (Italy)
Dinger, Ulla Margarete (Sweden)
Dinu, Liviu Florin (Romania)
Dinur, Irit Dveer (Israel)
Djoric, Mirjana (Serbia)
Dmitry, Artamonov (Russian Federation)
Doan, Trung Cuong (Vietnam)
Donne, Enrico Le (Switzerland)
Dontwi, Isaac Kwame (Ghana)
Dooley, Anthony Haynes (Australia)
Dowla, Arif (Bangladesh)
Drösser, Christoph (Germany)
Duarte, Isabel C. Da Silva (Portugal)
Dube, Mridula (India)
Dubey, Ashim (India)
Dubey, Dipti (India)
Dubey, Manish Kant (India)
Dubey, Umesh (India)
Dubois, Loïc Patrick M. J. (Finland)
Duduchava, Roland (Georgia)
Duminil-Copin, Hugo (Switzerland)
Dumortier, Freddy (Belgium)
Dung, Nguyen Viet (Vietnam)
Dungile, Maponyane (South Africa)
Dunne, Edward (USA)
Durán, Antonio José (Spain)
Durdevac, Natasa (Germany)
Durfee, Alan Hetherington (USA)
Dutt, Pravir Kumar (India)
Dutta, Joydeep (India)
Dutta, Sudipta (India)
Dutta, Tapan Kumar (India)
Dutta, Tarini Kumar (India)
Dwivedi, Shashank (USA)
Dwivedi, Shivanand (Italy)
Dwork, Cynthia (USA)
Easwaramoorthy, D. (India)
Echevarria-Libano, Maria Rosa (Spain)
Edward, Robert Victor (India)
Einsiedler, Manfred L. (Switzerland)
Ekhaguere, Godwin O. Samuel (Nigeria)
El-Guindy, Ahmad (Egypt)
Eloranta, Kari Väinö (Finland)
Elsabaa, Fawzy (Egypt)
Eltayeb, Ibrahim A. (Oman)
Elumalai, Nandakumar (India)
Elworthy, Kenneth David (U.K.)
Emilion, Marie Joseph Richard (France)
Emmerich, Patrick (Germany)
Engström, Alexander (USA)
Eom, Soo Kyung (Rep. Korea)
Eriksson, Anders Gustav Nils (Sweden)
Eskin, Alex (USA)
Espinoza, Ruben Flores (Mexico)
Esquivel-Avila, Jorge (Mexico)
Essel, Emmanuel Kwame (Ghana)
Eswara, A. T. (India)
Etchehoury, Maria Del R. (Argentina)
Evans, Steven Neil (USA)
Exner, Pavel (Czech Republic)
Ezhak, Svetlana (Russian Federation)
Fairweather, Graeme (USA)
Faizan, Danish (India)
Faizan, Mohd (India)
Fang, Jin-Hui (China)
Fang, Xiao (Singapore)
Fanja, Rakotondrajao (Madagascar)
Fasel, Jean Simon Nicolas (Switzerland)
Fathi, Albert (France)
Fathi, Max (France)
Fatima, Tanveer (India)
Fatima, Ummatul (India)
Faxen, Johan Birger (Sweden)
Feigon, Brooke Gabrielle (USA)
Ferenczi, Sébastien Simon (France)
Fernandez, Cesareo Jesus G. (Spain)
Fernando, Harshini (USA)
Ferreira, Helena Isabel (Portugal)
Feyzaabaadi, Saieed Akbari (Iran)
Fiel, Ana Maria Ferreras (USA)
Fintushel, Ronald (USA)
Firoozabadi, Sanaz Zare (Iran)
Fischer, Torsten (Germany)
Flexor, Marguerite (France)
Flores-Bazán, Fabián (Chile)

- Fomin, Sergey (USA)
 Fontaine, Jean-Marc (France)
 Forbes, Michael Andrew (India)
 Ford, Kevin Barry (USA)
 Fortin, Angel Ramon Pineda (USA)
 Francisco, Castro Jimenez (Spain)
 Frankowska, Helene (France)
 Freiburger, Marianne (U.K.)
 Fu, Jixiang (China)
 Fu, Xiaoyu (China)
 Fukumoto, Yoshihiro (Japan)
 Furkan, Mohd (India)
 Furstenberg, Harry (Israel)
 Fusco, Nicola (Italy)
- Gabai, David (USA)
 Gaboriau, Damien (France)
 Gaddam, Sethu Madhava Rao (India)
 Gadde, Anandaswarup (Australia)
 Gadgil, Siddhartha (India)
 Gaiko, Valery (Belarus)
 Gaikwad, Priyanka Balasaheb (India)
 Gairola, Umesh Chandra (India)
 Galarza, Maria J. Esteban (France)
 Gallagher, Isabelle (France)
 Galligo, Andre (France)
 Ganatra, Sheel Chandrakant (USA)
 Ganesan, G. (India)
 Ganesh, Swaminathan (India)
 Gangadharan, Sai Sundara K. (India)
 Gangammanahalli, Gurubasavara
 (India)
 Gangavamsam, Raja Sekhar Pydi (India)
 Gangopadhyay, Mukti (India)
 Ganguly, Dilip Kumar (India)
 Ganguly, Shirshendu (India)
 Gangwar, Pushpender Kumar (India)
 Garba, Babangida Bala (Nigeria)
 Garcia, Isabel Maria Rodriguez (Spain)
 Garcia, Jesus Martinez (U.K.)
 Garcia, Jose Maria Espinar (Spain)
 Garcia, Ruben Jose Sanchez (Germany)
 Garg, Anjali (India)
 Garg, Gaurav (India)
 Garg, Manish (India)
 Garg, Shelly (India)
 Garg, Vishal (India)
 Garge, Anuradha (India)
 Garge, Shripad M. (India)
 Garimella, Rama Murthy (India)
 Garrido, Adonay Jose J. (Colombia)
 Garrisi, Daniele (Rep. Korea)
 Garrod, Bryn James (U.K.)
 Gasparim, Elizabeth Terezinha (U.K.)
 Gatabi, Abolfazl Rafepour (Iran)
 Gatto, Angel Eduardo (USA)
- Gauthier, Paul Montpetit (Canada)
 Gautam, Sunil Kumar (India)
 Gavrilova, Liudmila (Russian Federation)
 Geer, Sara Anna Van De (Switzerland)
 Gejji, Varsha (India)
 Gelfand, Sergei (USA)
 Geoghegan, Ross (USA)
 George, Diana Mary (India)
 George, Mary (India)
 George, Santhosh (India)
 George, Shiju (India)
 German, Oleg (Russian Federation)
 Ghahramani, Saeed (USA)
 Ghanbari, Maryam (Iran)
 Ghate, Eknath Prabhakar (India)
 Ghevariya, Sanjay (India)
 Ghodadra, Bhikha Lila (India)
 Ghomroodi, Seyed Ali Reza (Iran)
 Ghorbani, Ebrahim (Iran)
 Ghorpade, Sudhir R. (India)
 Ghosh, Debashis (India)
 Ghosh, Shamik (India)
 Ghosh, Subhroshekhar (USA)
 Ghosh, Tuhin (India)
 Ghys, Etienne (France)
 Gibson, Nathan Louis (USA)
 Giral, Carlos Bosch (Mexico)
 Giri, Bibhas Chandra (India)
 Girija, Sagi Venkata Sesha (India)
 Girish, Prabhakaran (India)
 Glibichuk, Alexey (Mexico)
 Gochhayat, Priyabrat (India)
 Goldblatt, Robert (New Zealand)
 Goldman, William (USA)
 Gollakota, Veera Venkata H. (India)
 Golubitsky, Martin Aaron (USA)
 Gómez, Eugenia Saorín (Germany)
 Gondard, Danielle (France)
 Gong, Fuzhou (China)
 Gongopadhyay, Krishnendu (India)
 Gonzalez, Luis Vega (Spain)
 Gopal, Sharan (India)
 Gopalkrishnan, Manoj (India)
 Gorai, Sushil (India)
 Gordon, Iain Grant (U.K.)
 Gorodski, Claudio (Brazil)
 Gorty, V. R. Lakshmi (India)
 Goswami, Alok Kumar (India)
 Goswami, Anindya (France)
 Goswami, Deepjyoti (India)
 Gottlieb, Daniel Henry (USA)
 Gountia, Sujata (India)
 Govaerts, Willy J. Florent (Belgium)
 Govardhan (India)
 Govindasamy, Karunambigai M. (India)
 Gowers, William Timothy (U.K.)

- Gowrisankaran, Kohur (Canada)
Goyal, Anil (India)
Goyal, Kavita (India)
Goyal, Ranjan (India)
Graham, John Jeffrey (Australia)
Grasso, Thomas Nicholas (USA)
Greenberg, Ralph (USA)
Griette, Xavier (France)
Grodal, Jesper Kragh (Denmark)
Groenewald, Nicolas J. (South Africa)
Groetschel, Martin (Germany)
Grossman, Pinhas (U.K.)
Grover, Deepak (India)
Grover, Priyanka (India)
Grover, Vinod (India)
Grupel, Uri (Israel)
Gu, Yoon Hoe (Rep. Korea)
Gudapati, Nishanth Abu (Germany)
Guddati, Chakradhararao (India)
Gudi, Tirupathi (India)
Guha, Pathik (India)
Guha, Rangan Kumar (India)
Guha, Suman (India)
Guin, Satyajit (India)
Gun, Sanoli (India)
Guo, Ren (USA)
Guo, Xuejun (China)
Gupta, Anjan (India)
Gupta, Bhanu (India)
Gupta, Bharti (India)
Gupta, Hari Shanker (India)
Gupta, Kapil (India)
Gupta, Manish Kumar (India)
Gupta, Mohak (India)
Gupta, Murli (USA)
Gupta, Nitin (India)
Gupta, Praveen Kumar (India)
Gupta, Punam (India)
Gupta, Radha Charan (India)
Gupta, Shalini (India)
Gupta, Shiv (India)
Gupta, Shiv Kumar (USA)
Gupta, Shri Ram (India)
Gupta, Subhojoy (USA)
Gupta, Urvashi (India)
Gupta, Ved Prakash (India)
Gupta, Vishakha (India)
Gurjar, Sudarshan (India)
Gurtu, Vishnu Kumar (India)
Gurubilli, Kiran Kumar (India)
Gurudwan, Niyati (India)
Guruswami, Venkatesan (USA)
Guseynov, Sharif E. (Latvia)
Gusic, Dzenan (Bosnia and Herzegovina)
Guth, Lawrence David (Canada)
Gutierrez, Raquel Villacampa (Spain)
Gyllenberg, Mats-Anders (Finland)
Gyori, Ervin Albert (Hungary)
Ha, Huy Vui (Vietnam)
Ha, Le Thi Thanh (Vietnam)
Ha, Truong Xuan Duc (Vietnam)
Hacon, Christopher (USA)
Haddou, Hassan Ait (France)
Hag, Per (Norway)
Hagelstein, Paul Alton (USA)
Hai, Ngo Thanh (Vietnam)
Halai, Anjum (Tanzania)
Hales, Thomas Callister (USA)
Hamada, Tatsuyoshi (Japan)
Hamenstädt, Ursula (Germany)
Hamidou, Toure (Burkina Faso)
Han, Ji Young (Rep. Korea)
Han, Kang Jin (Rep. Korea)
Han, Sang-Eon (Rep. Korea)
Handa, Nidhi (India)
Hans-Gill, Rajinder (India)
Haque, Ziaul (India)
Haridas, Deepthi (India)
Harikumar, E. (India)
Harkmahn, Kim (Rep. Korea)
Harris, Jessica Diane (USA)
Harunori, Nakatsuka (Japan)
Hasan, S. N. (India)
Hasan, Sartaj Ul (India)
Hasmani, Abdulvahid (India)
Hayrapetyan, Hrachik (Armenia)
Hazarika, Bipan (India)
Hazra, Rajat Subhra (India)
Hazra, Subhendu Bikash (Germany)
Heath-Brown, David Rodney (U.K.)
Hebert, Michel (Egypt)
Hein, Maria Salett Biembengut (Brazil)
Heinze, Joachim (Germany)
Helffer, Bernard Henri (France)
Helfgott, Harald Andres (U.K.)
Helminck, Aloysius Gerardus (USA)
Hempfling, Thomas (Switzerland)
Henniart, Guy (France)
Henstridge, John David (Australia)
Hertz, Federico Juan R. (Uruguay)
Hezlet, Susan Patricia (U.K.)
Hinz, Andreas M. (Germany)
Ho, Minh Toan (Vietnam)
Hoa, Le Tuan (Vietnam)
Hogadi, Amit (India)
Holden, Helge (Norway)
Hollander, Wilhelmus Den (Netherlands)
Holte, John Myrom (USA)
Honary, Taher Ghasemi (Iran)
Hong, Kyusik (Rep. Korea)
Horiuchi, Toshio (Japan)

- Hornung, Peter Michael (U.K.)
 Hota, Tapan Kumar (India)
 Hoz, Francisco De La (Spain)
 Hsu, Elton P. (USA)
 Hsu, Sze-Bi (Taiwan)
 Huang, Zhaoyong (China)
 Huggett, Stephen (U.K.)
 Hughes, Kenneth Robert (South Africa)
 Hughes, Kevin James (USA)
 Hughes, Thomas Joseph (USA)
 Hulsurkar, Suresh Govindrao (India)
 Hunt, John Herbert V. (South Africa)
 Husain, Akhlaq (India)
 Hussain, Syed Zakir (India)
 Hutchings, Michael (USA)
 Huybrechts, Daniel (Germany)
 Hwang, Chul Ju (Rep. Korea)
 Hwang, Dongseon (Rep. Korea)
 Hwang, Jun-Muk (Rep. Korea)
- Ibragimov, Zafar (Uzbekistan)
 Ibragimov, Zair (USA)
 Iglesia, Manuel Dominguez De La (USA)
 Igodt, Paul G. (Belgium)
 Ih, Su Ion (USA)
 Ilangovan, Sankaranarayanan (India)
 Illera, Rafael Orive (Spain)
 Im, Bok Hee (Rep. Korea)
 Im, Sun Woo (Rep. Korea)
 Imaykin, Valery (Russian Federation)
 Ino, Hiroyuki (Japan)
 Inoue, Shuntaro (Japan)
 Ion, Patrick David Fraser (USA)
 Iqbal, Akhlaq (India)
 Iqbal, Javid (India)
 Iranmanesh, Ali (Iran)
 Irulappasamy, Jeyaraman (India)
 Islam, Md. Rabiul (India)
 Its, Alexander (USA)
 Its, Elizabeth (USA)
 Iturriaga, Renato (Mexico)
 Ivan, Gabor (Hungary)
 Ivanov, Sergey (Russian Federation)
 Ivic, Aleksandar (Serbia)
 Iwata, Satoru (Japan)
 Iyengar, S. Lakshmi (India)
 Iyengar, T. K. V. (India)
 Izumi, Masaki (Japan)
- Jabeen, Syeda Darakhshan (India)
 Jackowski, Stefan Maria (Poland)
 Jackson, Lee Wie Mien (India)
 Jafari, Hossein (Iran)
 Jahan, Qaiser (India)
 Jain, Harsh Vardhan (India)
 Jain, Rahul (USA)
- Jain, Rama (India)
 Jain, Rupali (India)
 Jain, Sanjay (India)
 Jain, Sapna (India)
 Jain, Sonal (USA)
 Jain, Sreepath (India)
 Jain, Surender Kumar (USA)
 Jain, Tanvi (India)
 Jaiswal, Jai Prakash (India)
 Jaiswal, Monika (India)
 Jaiyeola, Temitope Gbolahan (Nigeria)
 Jakelic, Dijana (USA)
 Jamal, Malik Rashid (India)
 Jamsranjav, Davaadulam (Mongolia)
 Jamwal, Dalip Singh (India)
 Jan, Yves Le (France)
 Jana, Joydip (India)
 Jana, Purbita (Netherlands)
 Jana, Sandip (India)
 Janardhan, Sujatha (India)
 Jang, Sun Young (Rep. Korea)
 Janitzio, Mejia Huguet Virgilio (Mexico)
 Januszkiewicz, Lech Tadeusz (Poland)
 Jayanarayanan, C. R. (India)
 Jayanthan, A. J. (India)
 Jayanthi, (India)
 Jayasurya, Y. Venkata (India)
 Jayram, Kaavya (USA)
 Jefferies, Brian (Australia)
 Jeltsch, Rolf (Switzerland)
 Jena, Susil Kumar (India)
 Jenaliyev, Muvasharkhan (Kazakhstan)
 Jeong, Hyosuk (Rep. Korea)
 Jeong, Wonjeong (Rep. Korea)
 Jha, Anuradha (India)
 Jha, Kanhaiya (Nepal)
 Jha, Somnath (India)
 Jhankal, Anuj Kumar (India)
 Jhanwar, Mahabir Prasad (India)
 Ji, Lizhen (USA)
 Jimenez, Debora (Colombia)
 Jimenez, Marina Lucia Logares (Spain)
 Jiménez, Santos González (Spain)
 Jin, Sunsook (Rep. Korea)
 Jindal, Ragini (India)
 Jing, Naihuan (USA)
 Jo, Ga Hyun (Rep. Korea)
 Joachim, Michael (Germany)
 Joe, Dosang (Rep. Korea)
 Johanson, Bengt (Sweden)
 John, Mohamed Sheik (India)
 John, Sunil Jacob (India)
 Johnson, Sam (India)
 Jonathan, Fernandes (India)
 Jones, Peter (USA)
 Jonnalagedda, Vasundhara Devi (India)

- Jose, Sona (India)
Jose, K. P. (India)
Joseph, Alphy (India)
Joseph, Dhannya Puthanpurayil (India)
Joseph, Mathew (USA)
Joshi, Kanchan (India)
Joshi, Mahesh Chandra (India)
Joshi, Milan (India)
Joshi, Nalini (Australia)
Joshi, Navneet (India)
Joshi, Vinayak (India)
Jothilingam, Ponnuswamy (India)
Jr, James Ripley Bozeman (USA)
Jung, Jaeho (Rep. Korea)
Jung, Ji Hye (Rep. Korea)
Jung, Tacksun (Rep. Korea)
Just, Andrzej (Poland)
- Kabbur, Smita (India)
Kadia, Atulkumar Vasudev (India)
Kadu, Ganesh (India)
Kähler, Uwe (Portugal)
Kahn, Bruno Philippe Michel (France)
Kaila, Anjana (India)
Kaiser, Tobias (Germany)
Kajimoto, Hiroshi (Japan)
Kakarala, Ramakrishna (Singapore)
Kalai, Gil (Israel)
Kale, Ashwini (India)
Kaledin, Dmitry (Russian Federation)
Kaligatla, Ramana Babu (India)
Kalita, Bimalendu (India)
Kalita, Deepjyoti (India)
Kallen, Wilberd Van Der (Netherlands)
Kalmenov, Tynysbek S. (Kazakhstan)
Kalyanasundaram, Subramaniam (India)
Kamaludheen, Ali Akbar (India)
Kamaraju, Annapurna (India)
Kaminaga, Masahiro (Japan)
Kaminski, Marcin Jakub (Belgium)
Kananthai, Amnuay (Thailand)
Kanda, Mohan (India)
Kang, Bowon (Rep. Korea)
Kang, Seok-Jin (Rep. Korea)
Kangro, Urve (Estonia)
Kania-Bartoszyńska, Joanna (USA)
Kannan, Manju (India)
Kannan, Ravindran (India)
Kannan, V. (India)
Kanoria, Mridula (India)
Kapoor, Saurabh (India)
Kappadathottiyilkumaran, Thampi (India)
Kaptanoglu, Semra (Turkey)
Kapur, Shashidhar (India)
Kapustin, Anton Nikolayevich (USA)
- Kar, Rasmita (India)
Kar, Sukhendu (India)
Kar, Tapan Kumar (India)
Karakkatt, Sunil Mathew (India)
Karamzadeh, Omid Ali Shihini (Iran)
Karandikar, Rajeeva Laxman (India)
Karanjgaokar, Varsha (India)
Karczewska, Anna Stefania (Poland)
Karippadath, Surendran (India)
Karjanto, Natanael (Malaysia)
Karmanova, Maria (Russian Federation)
Karpenko, Nikita (France)
Karthek, K. Naga (India)
Karthik (India)
Karthikeyan, Kadhavoor R. (India)
Karthikselvan, Sachithanandam (India)
Karulina, Elena (Russian Federation)
Karuvachery, Pravas (India)
Kashiwara, Masaki (Japan)
Kashyap, Navin (Canada)
Kasyanov, Viktor (Russian Federation)
Katipally, Manohar Reddy (India)
Katona, Gyula Gabor (Hungary)
Katre, Shashikant Anant (India)
Katsepor, Thomas (Ghana)
Katsura, Toshiyuki (Japan)
Kattumannil, Sudheesh Kumar (India)
Kaur, Harpreet (India)
Kaur, Manwinder (India)
Kaur, Navjot (India)
Kaushik, Prapulla (India)
Kavyrchine, Alexis (France)
Kawamata, Yujiro (Japan)
Kayal, Neeraj (India)
Kazuhiro, Sakue (Japan)
Kedlaya, Kiran Sridhara (USA)
Kedukodi, Babushri Srinivas (India)
Keener, Lee Lanam (Canada)
Keller, Thomas Michael (USA)
Kendre, Subhash (India)
Kenig, Carlos (USA)
Kennedy, Felbin C. (India)
Kennedy, Joseph (India)
Kergilova, Tatiana (Russian Federation)
Kerman, Ronald Allen (Canada)
Kesavan, Srinivasan (India)
Keshari, Dinesh Kumar (India)
Keshari, Manoj (India)
Kesiraju, Sarada (India)
Kesten, Harry (USA)
Ketu, Navin (India)
Kewat, Pramod Kumar (India)
Keyfitz, Barbara (USA)
Khadekar, Gowerdhan (India)
Khairnar, Shamkant (India)
Khairnar, Vilas (India)

- Khaksari, Ahmad (Iran)
 Khaliq, Masood (South Africa)
 Khambholja, Vrajeshkumar (India)
 Khan, Aiyub (India)
 Khan, Akhtar Ali (USA)
 Khan, Almas (India)
 Khan, Arbaz (India)
 Khan, Asif (India)
 Khan, Syed Huzoorul Hasnain (India)
 Khan, Zubair (India)
 Khandai, Tanusree (India)
 Khandelwal, Nidhi (India)
 Khandelwal, Pooja (India)
 Khanduja, Sudesh (India)
 Kharat, Vilas Sheshrao (India)
 Khare, Chandrashekhar (USA)
 Khassa, Ramneek (India)
 Khattar, Dinesh (India)
 Khedkar, Rupali (India)
 Khimshiashvili, Giorgi (Georgia)
 Khosravi, Behrooz (Iran)
 Khosravi, Maryam (Iran)
 Khosroshahi, Gholamreza B. (Iran)
 Khot, Subhash Ajit (USA)
 Khots, Boris (USA)
 Khuong, Nguyen An (Vietnam)
 Khurana, Aarti (India)
 Khurana, Dinesh (India)
 Kibret, Tadesse (Ethiopia)
 Kiefer, Frank Michael (Germany)
 Kikuchi, Keiichi (Japan)
 Kilicman, Adem (Malaysia)
 Kim, Chang-Wan (Rep. Korea)
 Kim, Dohan (Rep. Korea)
 Kim, Dongyung (Rep. Korea)
 Kim, Ho Sung (Rep. Korea)
 Kim, Hoil (Rep. Korea)
 Kim, Hyungjoon (Rep. Korea)
 Kim, Jeong Han (Rep. Korea)
 Kim, Jong Myung (Rep. Korea)
 Kim, Joonhyung (Rep. Korea)
 Kim, Jungsoo (Rep. Korea)
 Kim, Kwang Ik (Rep. Korea)
 Kim, Min-Young (Rep. Korea)
 Kim, Myung Hwan (Rep. Korea)
 Kim, Seonja (Rep. Korea)
 Kim, Seung Hyeok (Rep. Korea)
 Kim, Yeong Rak (Rep. Korea)
 Kim, Youngjin (Rep. Korea)
 Kimura, Takashi (USA)
 Kiran, Uday (India)
 Kiran Kumar, V. B. (India)
 Kiranagi, Basavannappa S. (India)
 Kirschenhofer, Peter (Austria)
 Kirwan, Frances Clare (U.K.)
 Kisaka, Masashi (Japan)
 Kiselman, Christer Oscar (Sweden)
 Kishan, Naikoti (India)
 Kishi, Yasuhiro (Japan)
 Kishorsinh, Moriya Bhavinkumar (India)
 Kisin, Mark (USA)
 Kisel, Ali Ulas Ozgur (Turkey)
 Kiss, György (Hungary)
 Kitano, Teruaki (Japan)
 Kitture, Rahul (India)
 Kjeldsen, Tinne Hoff (Denmark)
 Klaus, Stephan (Germany)
 Kleiven, Thomas (Norway)
 Knezevic-Miljanovic, Julka (Serbia)
 Knus, Max Albert (Switzerland)
 Kobak, Piotr Zdzislaw (Poland)
 Kobayashi, Masanori (Japan)
 Kocsard, Alejandro (Brazil)
 Kodama, Hiroki (Japan)
 Kodiyalam, Vijay (India)
 Koelsch, Hans Juergen (USA)
 Kogta, Ronak (India)
 Koh, Sung Eun (Rep. Korea)
 Kohirkar, Ambika (India)
 Kohli, Daman Singh (India)
 Koiso, Miyuki (Japan)
 Kokocki, Piotr (Poland)
 Kolagani, Srilakshmi (India)
 Komal, Bhajan Singh (India)
 Komech, Alexander (Russian Federation)
 Kompaniets, Lidia (Russian Federation)
 Kondo, Takefumi (Japan)
 Konwar, Stuti Borgohain (India)
 Koo, Namjip (Rep. Korea)
 Kopylova, Elena (Russian Federation)
 Koropecki, Andres (Brazil)
 Korte, Riikka (Finland)
 Koshiba, Yoichi (Japan)
 Koshy, Jacob P. (India)
 Koskela, Pekka Johannes (Finland)
 Kosuru, G. Sankara Raju (India)
 Kothari, Pravesh Kumar (India)
 Kour, Surjeet (India)
 Kozłowska-Walania, Ewa D. (Poland)
 Kraljevic, Hrvoje (Croatia)
 Kramer, Jürg (Germany)
 Kremer, Darla (USA)
 Krieger, Wolfgang Josef (Germany)
 Krishna, P. Radha (India)
 Krishna, Panthangi Murali (India)
 Krishnan, Balachandran (India)
 Krishnapur, Manjunath (India)
 Krishnasamy, Vasudevan (India)
 Kroeger, Heinz (Germany)
 Krol, Jerzy (Poland)
 Kryzhevich, Sergey (Russian Federation)
 Kucche, Kishor Deoman (India)

- Kuchibhotla, Adithya (India)
Kuijlaars, Arnoldus B. J. (Belgium)
Kukreja, Vaibhav (USA)
Kukreja, Vijay (India)
Kuku, Aderemi (USA)
Kulcsár, Cecilia (Hungary)
Kulkarni, Adinath (India)
Kulkarni, Dheeraj Dattatray (India)
Kulkarni, Ravindra Shripad (India)
Kulshreshtha, Vasudha A. (India)
Kulshreshtha, Amit (India)
Kumar, Abhinav (USA)
Kumar, Ajay (India)
Kumar, Ajit (India)
Kumar, Alpesh (India)
Kumar, Amit (India)
Kumar, Arun (India)
Kumar, Ashisha (India)
Kumar, Ashok (India)
Kumar, B. V. Rathish (India)
Kumar, Deepak (India)
Kumar, Devendra (India)
Kumar, Dilip (India)
Kumar, Girraj (India)
Kumar, K. Bhargav (India)
Kumar, M. Shiva (India)
Kumar, Manoj (India)
Kumar, Mritunjay (India)
Kumar, N. Shravan (India)
Kumar, Neeraj (India)
Kumar, Pallati Aditya Vardhan (India)
Kumar, Pradip (India)
Kumar, Prashant (Rep. Korea)
Kumar, Pratyosh (India)
Kumar, Rajesh (India)
Kumar, Rakesh (India)
Kumar, Ravi (India)
Kumar, Romesh (India)
Kumar, Sachin (India)
Kumar, Sandeep (India)
Kumar, Sanjay (India)
Kumar, Sanjeev (India)
Kumar, Satish (India)
Kumar, Shiv (India)
Kumar, Shiv Datt (India)
Kumar, Shrawan (USA)
Kumar, Sudarshan (India)
Kumar, Suman (India)
Kumar, Sunil (India)
Kumar, Surendra (India)
Kumar, Surjit (India)
Kumar, Vikas (India)
Kumar, Virender (India)
Kumar, Virendra (India)
Kumar, Yajuvindra (India)
Kumaran, Leenakumari K. (India)
Kumaraswamy (India)
Kumaraswamy, Vinay (India)
Kumaresan, Premalatha (India)
Kumaresan, Somaskandan (India)
Kumari, Shashi (India)
Kumawat, Sunita (India)
Kumlin, Jan Peter Anders (Sweden)
Kun, Gabor (USA)
Kuncham, Syam Prasad (India)
Kundu, Satyabrota (India)
Kunhanandan, Mailattu (India)
Kunisch, Karl (Austria)
Kupiainen, Antti Jukka (Finland)
Kurahatti, Basavaraj (India)
Kuroki, Shintaro (Rep. Korea)
Kushwaha, Jitendra Kumar (India)
Kustarev, Andrey (Russian Federation)
Kutzschebauch, Werner (Switzerland)
Kuzichev, Alexander (Russian Federation)
Kwak, Minkyu (Rep. Korea)
Kwak, Si Jong (Rep. Korea)
Kwon, Ohsang (Rep. Korea)
Kye, Young Hee (Rep. Korea)
Lachowska, Anna (USA)
Lackenby, Marc (U.K.)
Lafuerza-Guillén, Bernardo (Spain)
Lahiri, Abhijit (India)
Lahiri, Ananya (India)
Lai, Hsin-Hao (Taiwan)
Laipubam, Bhamini Sharma (India)
Laishram, Shanta Singh (India)
Lakshmi, Burra (India)
Lakshmibai, Venkatramani (USA)
Lal, Nishu (USA)
Lalithambigai, Sundara Moorthy (India)
Lando, Sergey (Russian Federation)
Lap, James T. (USA)
Lapid, Erez Moshe (Israel)
Laptev, Ari (U.K.)
Last, Yoram (Israel)
Laumon, Genevieve Raugel Ep. (France)
Laumon, Gerard Henri Leon (France)
Lavanya, R. Lakshmi (India)
Lawton, Sean Dodd (USA)
Le, Cong Trinh (Vietnam)
Le, Nam Quang (USA)
Le, Truong Hoang (Vietnam)
Lê, Út V. (Finland)
Lebow, Eli Bohmer (India)
Leclerc, Bernard (France)
Lee, Bo Seop (Rep. Korea)
Lee, Donghi (Rep. Korea)
Lee, Dongil (Rep. Korea)
Lee, Dongmin (Rep. Korea)

- Lee, Ellen (Rep. Korea)
 Lee, Eon-Kyung (Rep. Korea)
 Lee, Han Ju (Rep. Korea)
 Lee, Hang-Sook (Rep. Korea)
 Lee, Hwayoung (Rep. Korea)
 Lee, Hwayoung (Rep. Korea)
 Lee, Ju A. (Rep. Korea)
 Lee, Juhee (Rep. Korea)
 Lee, Jung-Jo (Rep. Korea)
 Lee, Juri (Rep. Korea)
 Lee, Keonhee (Rep. Korea)
 Lee, Kwankyu (Rep. Korea)
 Lee, Kyu-Hwan (USA)
 Lee, Manseob (Rep. Korea)
 Lee, Minku (Rep. Korea)
 Lee, Nam-Hoon (Rep. Korea)
 Lee, Para (Rep. Korea)
 Lee, Sang-Jin (Rep. Korea)
 Lee, Seok Min (Rep. Korea)
 Lee, Seunghun (Rep. Korea)
 Lee, Sung Chul (Rep. Korea)
 Lee, Wanseok (Rep. Korea)
 Lee, Young Min (Rep. Korea)
 Lee, Youngae (Rep. Korea)
 Lee, Yuh-Jia (Taiwan)
 Leitão, Antonio (Brazil)
 Lellis, Camillo De (Switzerland)
 Lenstra, Hendrik Willem (Netherlands)
 Leon, Manuel De (Spain)
 Leonori, Tommaso (Spain)
 Lesmono, Dharma (Indonesia)
 Leuschke, Graham Joseph (USA)
 Levesque, Claude (Canada)
 Levitin, Michael (U.K.)
 Li, Gang (China)
 Li, Hengguang (USA)
 Li, Wenbo (USA)
 Li, Yanyan (USA)
 Liaw, Constanze Dong-Li (USA)
 Liebana, Carlos Escudero (Spain)
 Lih, Ko-Wei (Taiwan)
 Lilly, P. L. (India)
 Lim, Jung Wook (Rep. Korea)
 Lim, Wee Keong (Malaysia)
 Linan, Maria Barbero (Canada)
 Lindenstrauss, Elon Bruno (Israel)
 Lindsay, John Martin (U.K.)
 Lineesh, M. C. (India)
 Linh, Nguyen Hoai (Vietnam)
 Linial, Nathan (Israel)
 Liu, Chiu-Chu (USA)
 Liu, Tai-Ping (Taiwan)
 Liverpool, Lennox S. O. (Nigeria)
 Llado, Anna (Spain)
 Lockhart, Deborah Frank (USA)
 Lodha, Yash (USA)
 Loeser, Francois (France)
 Loew, Elizabeth (USA)
 Loewe, Benedikt (Netherlands)
 Loganathan, Nalinidevi (India)
 Loh, Po-Shen (USA)
 Lokam, Satyanarayana V. (India)
 Lomonaco, Luciana Luna (Denmark)
 Lone, Nisar Ahmad (India)
 Longani, Vites (Thailand)
 Longhi, Ignazio (Italy)
 Lonka, Sampath (India)
 Lopez, Consuelo Martinez (Spain)
 López-Fidalgo, Jesús Fernando (Spain)
 Lorentzen, Lisa (Norway)
 Loseu, Ivan (USA)
 Louhan, Pooja (India)
 Louwsma, Joel (USA)
 Lovasz, Laszlo (Hungary)
 Lubuma, Mbaro-Saman (South Africa)
 Luca, Florian (Mexico)
 Lueck, Wolfgang (Germany)
 Lundh, Torbjörn (Sweden)
 Lurie, Jacob Alexander (USA)
 Lyche, Tom Johan Wiborg (Norway)
 Ma, Chunhua (China)
 Ma, Insook (Rep. Korea)
 Ma, Xiaonan (France)
 Ma, Zhiming (China)
 Maas, Jan (Germany)
 Maccallum, Malcolm Angus Hugh (U.K.)
 Machchhar, Jinesh Chandrakant (India)
 Macintyre, Angus John (U.K.)
 Madan, Shobha (India)
 Madanshekaf, Ali (Iran)
 Maddala, Sundari (India)
 Maddaly, Krishna (India)
 Madhavadas, M. (India)
 Madhavan, G. (India)
 Madhu (India)
 Madiman, Mokshay Mohan (India)
 Madsen, Lars Backe (Norway)
 Madzwamuse, Anotida (U.K.)
 Magaia, Lourenco Lazaro (Mozambique)
 Magero, John Mango (Uganda)
 Maguire, Shaun Mac Bride (USA)
 Mahale, Pallavi (India)
 Mahato, Ashutosh (India)
 Maheshwari, Aditya (India)
 Maheshwari, N. Uma (India)
 Maheswaram, Ravi Chandra (India)
 Maheswari, Bommireddy (India)
 Maheswari, Uma (India)
 Maingi, Damian (Kenya)
 Maini, Philip Kumar (U.K.)
 Maitra, Jitendra Kumar (India)

- Maity, Soma (India)
Majumdar, Dipramit (USA)
Majumdar, Kanan (India)
Majumdar, Manjusha (India)
Makhija, Kamyra (India)
Makinde, Oluwole Daniel (South Africa)
Malaspina, Uldarico (Peru)
Malekar, Rajanish (India)
Malhotra, P. K. (India)
Malhotra, Richa (India)
Malik, Amita (India)
Malik, Prasanta (India)
Malinina, Natalia (Russian Federation)
Malladi, Sitaramayya (India)
Mallikarjuna Rao, M. (India)
Malmuni, Ranasinghe P. K. (Sri Lanka)
Maloni, Sara (U.K.)
Malonza, David Mumo (Kenya)
Maloo, Alok Kumar (India)
Mamadaliyev, Nazirjan (Uzbekistan)
Mamadsho, Ilolov (Tajikistan)
Manchanda, Pammy (India)
Mandal, Anandadeep (India)
Mandal, Ashis (Luxembourg)
Mandal, B. N. (India)
Mandal, Dhananjay (India)
Mandal, Dinbandhu (India)
Mandal, Partha (India)
Mande, Nikhil S. (India)
Maneklal, Prajapati Udayan (India)
Manga, Adamu Muhammad (Nigeria)
Mangalambal, N. R. (India)
Mangang, Khundrakpam Binod (India)
Mangasuli, Anandateertha G. (India)
Manickam, Murugesan (India)
Manickam, Nachimuthu (USA)
Manjunath, Madhusudan (Germany)
Manna, Bhakti B. (India)
Manna, Utpal (India)
Manohar, Pratibha (India)
Manojlovic, Vesna (Serbia)
Mansfield, Elizabeth Louise (U.K.)
Mansfield, Keith Richard (U.K.)
Mansour, Zeinab (Egypt)
Manthripragada, Kalyani (India)
Manuylov, Vladimir (Russian Federation)
Marcolli, Matilde (USA)
Maria, Camacho Santana Luisa (Spain)
Maria, Cañete Molero Elisa (Spain)
Mariano, Rochelleo (Philippines)
Marica, Aurora Mihaela (Spain)
Markandeya, Virat (India)
Markowich, Peter (U.K.)
Markowich, Peter (Austria)
Markwardt, Sylwia (Germany)
Marques, Fernando (Brazil)
Marquis, Ludovic Jonathan (France)
Martha, Subash Chandra (India)
Martin, Gaven John (New Zealand)
Martin, Gregory George (Canada)
Martin, Maria Francisca Blanco (Spain)
Martinez, Adrian Ubis (Spain)
Martinez, Santos David Gonzalez (Spain)
Maryati, Tita Khalis (Indonesia)
Mase, Makiko (Japan)
Masson, Mathias (Finland)
Mastropietro, Vieri (Italy)
Masuti, Shreedevi (India)
Math, Shrishail (India)
Mathew, Deemat (India)
Matic, Ivan (USA)
Mato, Yamilet (Venezuela)
Matrapu, Sumanth Datt (India)
Matsumoto, Shigenori (Japan)
Matsuyama, Yoshio (Japan)
Mattila, Pertti Esko Juhani (Finland)
Maturi, Rama Durgakiran (India)
Matveev, Mikhail (Russian Federation)
Matveeva, Inessa (Russian Federation)
Maulik, Krishanu (India)
Maurya, Sunil Kumar (India)
Maydanskiy, Maksim Igorevich (USA)
Mazumdar, Eshita (India)
Mccallum, William Gordon (USA)
Mccammond, Jonathan Paul (USA)
Mcclure, Donald (USA)
Mcferson, Donovan Clark (USA)
Mckay, Brendan Damien (Australia)
Mckernan, James (USA)
Mclachlan, Robert Iain (New Zealand)
Meher, Jaban (India)
Mehrotra, Sukhendu (USA)
Mehta, Ghanshyam B. (Australia)
Mehta, Jay Gopalbhai (India)
Mehta, Vikram Bhagwandas (India)
Mei, Peng (Finland)
Melese, Dawit (India)
Melo, Artur Avila Cordeiro De (Brazil)
Melo, Wellington De (Brazil)
Memec, Nacima (Bosnia and Herzegovina)
Mendez, Patrice Osona De (France)
Mendoza, Alexander E. Arbieta (Brazil)
Menon, Manju K. (India)
Menon, Sajith Govindan Kutty (India)
Mercedes, Fernandez (Spain)
Merchant, Farhad (India)
Merel, Loïc (France)
Mette, Ina (Germany)
Meyer, Johannes Hendrik (South Africa)
Meyer, Yves Francois (France)

- Miatello, Roberto Jorge (Argentina)
 Midhun Raj, U. R. (India)
 Mielke, Alexander (Germany)
 Miller, John J. H. (Ireland)
 Min, Kyung Chan (Rep. Korea)
 Mincheva, Tanya (Bulgaria)
 Mira, José Antonio Cuenca (Spain)
 Mira, Pablo (Spain)
 Mironov, Andrey (Russian Federation)
 Mirzaei, Sedigheh (India)
 Mirzakhani, Maryam (USA)
 Mishra, Akanksha (India)
 Mishra, Akshaya Kumar (India)
 Mishra, Ashish (India)
 Mishra, Bimal (India)
 Mishra, Bivudutta (India)
 Mishra, Debashish (India)
 Mishra, Debasisha (India)
 Mishra, Dheerendra (India)
 Mishra, Indira (India)
 Mishra, Manoranjan (India)
 Mishra, Mukund Madhav (India)
 Mishra, Nachiketa (India)
 Mishra, Rama (India)
 Mishra, Ratnesh Kumar (India)
 Misra, Amit Kumar (India)
 Misra, Gadadhar (India)
 Misra, Umakanta (India)
 Mitra, Mahan (India)
 Mitra, Mukut (India)
 Mittal, Nikita (India)
 Mittal, Prachi (India)
 Miwa, Tetsuji (Japan)
 Moakher, Maher (Tunisia)
 Mockan, Pitchaimani (India)
 Mohammad, Ilyas (India)
 Mohammadian, Ali (Iran)
 Mohammed, Abubakr (India)
 Mohammed, Isa Baba (Nigeria)
 Mohammed Anvar, T. (India)
 Mohan, Devang S. Ram (India)
 Mohan, Manil T. (India)
 Mohan, Usha (India)
 Mohanty, Parasara (India)
 Mohanty, Sanjay Kumar (India)
 Mohanty, Sumit (India)
 Mohapatra, Anugraha Nidhi (India)
 Mohapatra, Subhashree (India)
 Mohri, Hiroaki (Japan)
 Mojumder, Probal (India)
 Molati, Motlatsi Ernest (Lesotho)
 Mombelli, Juan Martin (Argentina)
 Mondal, Amiya Kumar (India)
 Mondal, Arghya (India)
 Mondal, Ramnarayan (India)
 Monikarchana, Yathaluru (India)
 Montans, Fernando (Uruguay)
 Monto, Geethanjali (India)
 Moore, Justin (USA)
 Moothathu, T. K. Subrahmonian (India)
 Moran, Gadi (Israel)
 More, Meena (India)
 Morel, Sophie Marguerite (USA)
 Morgado, Hector F. Sanchez (Mexico)
 Morgan, Ruby Salestina (India)
 Mori, Yoshiyuki (Japan)
 Morris, Robert (Brazil)
 Morrison, Scott Edward (USA)
 Morye, Archana (India)
 Moslehian, Mohammad Sal (Iran)
 Moslemi, Bahman (Iran)
 Mostafazadehfard, Maral (Brazil)
 Mouhot, Clement (France)
 Moura, Adriano Adrega De (Brazil)
 Mourougane, Christophe Siva (France)
 Mousa, Abdelrahim S. A. (Portugal)
 Mousumi, Mandal (India)
 Mozumder, Muzibur (India)
 Mubeena, T. (India)
 Mudagi, Basaweshwar Sahebrao (India)
 Mudakkar, Syeda Rabab (U.K.)
 Mudur, G. S. (India)
 Mueller, Stefan (Germany)
 Mukerjee, Himadri Kumar (India)
 Mukhamedov, Farrukh (Malaysia)
 Mukherjee, Amiya (India)
 Mukherjee, Anjan (India)
 Mukherjee, Manabendra Nath (India)
 Mukherjee, Shyama Prasad (India)
 Mukhi, Sunil (India)
 Mukhopadhyay, Anirban (India)
 Mukhopadhyay, Parthasarathi (India)
 Mukhopadhyay, Swarnava (USA)
 Mumford, David Bryant (USA)
 Muñoz, Mario Eudave (Mexico)
 Munshi, Ritabrata (India)
 Murad, Abdullah (Bangladesh)
 Murali, Venkateswaran (South Africa)
 Muralidhara, V. N. (India)
 Murawski, Roman (Poland)
 Murmu, Ramakrishna (India)
 Murthy, K. P. N. (India)
 Murthy, Rashmi Venkatesh (India)
 Murthy, Sandeep (U.K.)
 Murthy, S. V. S. S. N. K. (India)
 Murty, Maruti Ram (Canada)
 Murty, P. S. Ramachandra (India)
 Murty, Vijayakumar (Canada)
 Murugan, Veerapazham (India)
 Mustansir, Barma (India)
 Muthkur, Aswathanarayan (India)
 Muthusamy, Appu (India)

- Na, Kyunguk (Rep. Korea)
Nabutovsky, Alexander (Canada)
Nadimpalli, Santosh (India)
Nadirashvili, Nikolay (France)
Nadkarni, Mahendra Ganpatrao (India)
Nagaiah, Chamakuri (Austria)
Nagalakshmi, Mangalampalli R. (India)
Naganathan, Jaya (India)
Nagar, Anima (India)
Nagaraju, Dasari (India)
Naidu, Deepak (USA)
Naik, Shweta Shripad (India)
Naik, Swatee (USA)
Nair, Lakshmi Chandrasekharan (India)
Nair, Sunil (U.K.)
Najafabad, Omid Ghayour (India)
Nakamura, Masayuki (Japan)
Nakamura, Tetsuo (Japan)
Nakane, Shizuo (Japan)
Näkki, Raimo Tapani (Finland)
Nam, Ki-Bong (USA)
Nam, Kye Sook (Rep. Korea)
Nambi, Muthukumar Thirumalai (India)
Namboothiri, K. Vishnu (India)
Namdari, Mehrdad (Iran)
Nandakumar, Nagaiah R. (USA)
Nandakumaran, Akambadath (India)
Nandkeolyar, Raj (India)
Nanduri, Ramakrishna (India)
Naor, Assaf (USA)
Narasimha, Prasanth G. S. (India)
Narasimha Chary, B. (India)
Narasimhan, Madumbai S. (India)
Narasimhan, Ramanujam (India)
Narasimhan, R. (India)
Narayan, Pushpa (India)
Narayanam, Nischal (India)
Narayanan, E. K. (India)
Narayanaraju, Nathiya (India)
Narayanaswami, Pallasena (Canada)
Nashine, Hemant Kumar (India)
Natarajan, Balasubramanian (India)
Natarajan, Jeyakumar (India)
Natarajan, Raja (India)
Nath, Gorakh (India)
Nath, Kalyan (India)
Nath, Triloki (India)
Navada, Kodi Gowri (India)
Navas, Andrés (Chile)
Nawata, Satoshi (Japan)
Nayak, Girish Chandra (India)
Nayak, Soumyashanth (India)
Nazarov, Fedor Lvovich (USA)
Nebres, Bienvenido F. (Philippines)
Nedungadi, Aatira Gopalkrishnan (India)
Negut, Andrei (USA)
Neithalath, Mohan Kumar (USA)
Neman, Azadeh (Turkey)
Nemenzo, Fidel (Philippines)
Neog, Bhaben Chandra (India)
Nesetril, Jaroslav (Czech Republic)
Nesterov, Iouri (Belgium)
Neuhauser, Claudia (USA)
Neumann, Frank (U.K.)
Nevanlinna, Olavi (Finland)
Newton, Rachel Dominica (U.K.)
Ngo, Bao Chau (USA)
Nguyen, An Tran (Vietnam)
Nguyen, Tien Dung (Vietnam)
Nie, Zhaohu (USA)
Nies, Andre O. (New Zealand)
Nigam, Rakesh (India)
Niharika, Yennum (India)
Nikandish, Reza (Iran)
Nikhil, M. G. (India)
Nilakantan, Nandini (India)
Nilsson, Thomas Olof (Sweden)
Nimbhorkar, Shriram (India)
Nimse, Sarjerao Bhaurao (India)
Nirenberg, Louis (USA)
Nixon, Fiona Campbell (U.K.)
Nobuaki, Takeda (Japan)
Nochetto, Ricardo Horacio (USA)
Noda, Takeo (Japan)
Nogueras, María (Spain)
Nolin, Pierre (USA)
Nuñez, Roberto Rubio (Spain)
Nurdin (Indonesia)
Oakes, Susan Margaret (U.K.)
Oberaigner, Eduard Roman (Austria)
Obryant, Kevin Wayne (USA)
Obukhovskiy, Valery (Russian Federation)
Octavia, Gaël Suzon (France)
Odagiri, Shinsuke (Japan)
Odai, Yoshitaka (Japan)
Odongo, Leo Odiwuor (Kenya)
O'Donovan, Donal (Ireland)
Ogana, Wandera (Kenya)
Ogiso, Keiji (Japan)
Oguntuase, James Adedayo (Nigeria)
Oh, Byung Geun (Rep. Korea)
Oh, Hee (USA)
Oh, Jumi (Rep. Korea)
Ojha, Aparajita (India)
Okada, Tatsuya (Japan)
Olanrewaju, Philip Oladapo (Nigeria)
Olatunji, Bode (Nigeria)
Olenko, Andriy (Australia)
Oli, Sanjay (India)
Oliveira, Bruno (Portugal)

- Olver, Peter John (USA)
 Onanaye, Samson (Nigeria)
 Onshuus, Alf (Colombia)
 Oprocha, Piotr Maciej (Spain)
 Ordóñez, Hugo Rodríguez (Mexico)
 O'Shea, Donal (USA)
 Osher, Stanley Joel (USA)
 Ouedraogo, Marie F. (Burkina Faso)
 Ouyang, Geng (China)
- Pacard, Frank (France)
 Pach, Péter Pál (Hungary)
 Pachaiyappan, Ramamurthy (India)
 Pachpatte, Deepak (India)
 Pacini, Marco (Brazil)
 Packwood, Daniel Miles (New Zealand)
 Padaliya, Sanjay (India)
 Padmanabha Rao, A. B. (India)
 Padmini, C. (India)
 Pahari, Ujjwal Kumar (India)
 Paiva, Francisco Odair De (Brazil)
 Pak, Eunmi (Rep. Korea)
 Pak, Hee Chul (Rep. Korea)
 Pal, Abhijit (India)
 Pal, Anita (India)
 Pal, Avijit (India)
 Pal, Madhumangal (India)
 Pal, Ratna (India)
 Pal, Samares (India)
 Pal, Sarbeswar (India)
 Pal, Sourav (India)
 Palaparthi, Anantha S. S. K. (India)
 Palis, Jacob (Brazil)
 Palomo, Alberto Carlos Elduque (Spain)
 Panayappan, S. (India)
 Panda, Gobinda Chandra (India)
 Panda, Ratikanta (India)
 Panda, Satyananda (India)
 Pande, Vijay Prakash (India)
 Pandey, Ambuj (India)
 Pandey, Ashish K. (India)
 Pandey, Neeta (India)
 Pandey, Prem Prakash (India)
 Pandey, Ram Kishor (India)
 Pandey, Ram Krishna (India)
 Pandey, Satyendra Nath (India)
 Pandey, Shared Chander (India)
 Pandey, Surabhi (India)
 Panigrahi, Bijaya Laxmi (India)
 Panigrahi, Motilal (India)
 Panigrahi, Saroj (India)
 Pant, Rajendra Prasad (India)
 Pant, Vyomesh (India)
 Pantoja, Jose Eduardo (Chile)
 Pantula, Sastry Gouripathi (USA)
 Parab, Abhishek (India)
- Paramanathan, Ponnaiyan (India)
 Pardeshi, Akhileshsingh (India)
 Parekh, Sandeepan (India)
 Parihar, Sudeep Singh (India)
 Park, Hee Sang (Rep. Korea)
 Park, Hye Sook (Rep. Korea)
 Park, Hyungbin (Rep. Korea)
 Park, Hyungju (Rep. Korea)
 Park, Inyoung (Rep. Korea)
 Park, Jinhyung (Rep. Korea)
 Park, Jong Youll (Rep. Korea)
 Park, Jongil (Rep. Korea)
 Park, Kyewon Koh (Rep. Korea)
 Park, Poo-Sung (Rep. Korea)
 Park, Sang-Hyeon (Rep. Korea)
 Park, Sung Ho (Rep. Korea)
 Parkash, Anand (India)
 Parmeggiani, Claudio (Italy)
 Parrilo, Pablo A. (USA)
 Parshin, Alexey (Russian Federation)
 Parthasarathy, Aprameyan (Germany)
 Parthasarathy, K. R. (India)
 Parthasarathy, Krishnan (India)
 Parthasarathy, Rajagopalan (India)
 Parthasarathy, Thiruvengkatachari (India)
 Parvathi, Sivasubramaniam (India)
 Paseman, Gerhard Raymond (USA)
 Passare, Mikael (Sweden)
 Passi, Inder Bir Singh (India)
 Paszkiewicz, Adam (Poland)
 Patel, Ajit (India)
 Patel, Arvindbhai (India)
 Patel, Rishiparna Rehana (USA)
 Patel, Sanjaykumar (India)
 Patel, Shiv Prakash (India)
 Pathak, Anil Kumar (India)
 Pathak, Anokhe Lal (India)
 Pathak, Ashok Kumar (India)
 Pathak, Mamta (India)
 Pathak, Ram Shankar (India)
 Pati, Kishor Chandra (India)
 Pati, Smita (India)
 Patil, Arunkumar (India)
 Patil, Prabhakar (India)
 Patnaik, Manish (USA)
 Patra, Kamal Lochan (India)
 Patra, Kuntala (India)
 Patra, Pinaki (India)
 Pattanaik, Suwendu Ranjan (India)
 Pattanayak, Santosha (India)
 Pattanayak, Swadheenananda (India)
 Patwardhan, Ajay (India)
 Paul, Chinmoy (India)
 Paul, Jagabandhu (India)
 Paul, Prabal (India)
 Paulin, Alexander George M. (USA)

- Paulin, Daniel (Singapore)
Paun, Mihai (France)
Pawale, Rajendra (India)
Pawar, Kishor (India)
Pawar, Neela R. (India)
Paycha, Sylvie (France)
Payne, Michael Stuart (Australia)
Paz, Gloria Leticia Brambila (Mexico)
Pedgaonkar, Anil (India)
Pedroza, Andres (Mexico)
Pejsachowicz, Jacobo (Italy)
Pekonen, Osmo Esko Tapio (Finland)
Pelloni, Beatrice (U.K.)
Peña, José Antonio De La (Mexico)
Peng, Jigen (China)
Peng, Shige (China)
Penumatsa, Subba Raju Venkata (India)
Pepe, Luigi (Italy)
Perez-Chavela, Ernesto (Mexico)
Persson, Ulf Anders (Sweden)
Perumal, Balakumar Ganapathi (India)
Peters, Alice (USA)
Peters, Klaus (USA)
Peterson, Ivars (USA)
Peterzil, Yaacov (Israel)
Petit, Lawrence (France)
Petrogradskiy, Victor (Russian Federation)
Petrow, Ian Nicholas (USA)
Peyon, Olivier (France)
Phan, Thi Ha Duong (Vietnam)
Phu, Hoang Xuan (Vietnam)
Phukan, Deva Kanta (India)
Piccione, Paolo (Brazil)
Piene, Ragni (Norway)
Pierro, Alvaro De (Brazil)
Pileckas, Konstantinas (Lithuania)
Pillay, Anand (U.K.)
Pinheiro, Diogo (Portugal)
Pinheiro, Susana Filipa (Portugal)
Pino, Manuel Adrian Del (Chile)
Pinto, Alberto Adrego (Portugal)
Pippich, Anna-Maria (Germany)
Piranna, Malgonde Shamrao (India)
Pires, Ana Rita Pissarra (USA)
Piric, Samra (Bosnia and Herzegovina)
Pironneau, Olivier (France)
Pirouz, Naiyer (India)
Pisanski, Tomaž (Slovenia)
Pisharody, Rahul V. (India)
Pisier, Gilles (France)
Pisolkar, Supriya Arvind (India)
Pital'skaya, Olga (Russian Federation)
Pjanic, Karmelita (Bosnia and Herzegovina)
Plata, Jose Antonio (Spain)
Plofker, Kim Leslie (USA)
Pluhár, Gabriella (Hungary)
Poddar, Mainak (India)
Podila, Pramod Chakravarthy (India)
Poelke, Konstantin (Germany)
Pollington, Andrew Douglas (USA)
Polo, Francisco Jose Fernandez (Spain)
Pommersheim, James Erik (USA)
Ponnada, Lalitha (India)
Porwal, Kamana (India)
Potluri, Venkata Rao (USA)
Pourkazemi, Mohammadhossein (Iran)
Prabakaran, R. (India)
Prabhakar, Madeti (India)
Prabhakar, Mannava Venkata (India)
Pradhan, Debasish (India)
Praeger, Cheryl Elisabeth (Australia)
Prajapati, Balchand (India)
Prajapati, Sunil (India)
Prakash, Gyan (India)
Prakash, Jai (India)
Prakash, Kuldeep (India)
Prakash, Om (India)
Prakash, Ravi (India)
Prakash, D. G. (India)
Pranesachar, Anil Chudamani (India)
Pranesachar, Chudamani R. (India)
Prasad, Akhilesh (India)
Prasad, Anjana (India)
Prasad, Appacherlaramakrishna (India)
Prasad, Dipendra (India)
Prasad, Karanamu Maruthi (India)
Prasad, Kothuri Lakshmi Sai (India)
Prasad, Krishna Chandra (India)
Prasad, Niraj (India)
Prasad, Srijanani Anurag (India)
Prashanth, Maraju (India)
Procesi, Claudio (Italy)
Prozorov, Oleg (Russian Federation)
Przytycki, Feliks Marian (Poland)
Pulickakunnel, Shaini (India)
Pupo, Mauro Misael García (Colombia)
Puri, Madan Lal (USA)
Puri, Nishant (India)
Purohit, Sunil Dutt (India)
Purusothaman, Suguna (India)
Pusti, Sanjoy (India)
Qin, Hourong (China)
Quach, Vi Tri (Finland)
Quastel, Jeremy (Canada)
Quintana, Yamilet (Venezuela)
Quraishi, Sarosh Mumtaz (India)
Rabarison, F. Patrick (France)
Radha, R. (India)

- Radhakrishna, Lanka (India)
 Radhakrishnan, Jaikumar (India)
 Radu, Remus Andrei (Romania)
 Raghava, Naresh (India)
 Raghavachar, Rangarajan (India)
 Raghavan, Komaranapuram N. (India)
 Raghavendar, K. (India)
 Raghunath, K. Goutham (India)
 Raghunathan, M. S. (India)
 Raghunathan, Ravi (India)
 Rahaman, Jeenath (India)
 Raheem, Abdur (India)
 Rahim, Mohammed Abdul (Saudi Arabia)
 Rahul (India)
 Rai, Bindhyachal (India)
 Rai, Pratima (India)
 Raina, Ashok Kumar (India)
 Rains, Eric Michael (USA)
 Raj, S. Francis (India)
 Raja, C. R. E. (India)
 Rajagopalan, Anand (USA)
 Rajagopalan, Padmanabha S. (India)
 Rajan, A. R. (India)
 Rajan, Ranjana (India)
 Rajaram, Nirup Kumar (India)
 Rajasingh, Angeline Chella R. (India)
 Rajendra, R. (India)
 Rajendran, Dhanya (India)
 Rajeswari, Kota Nagalakshmi (India)
 Rajkumar, Krishnan (India)
 Raju, Suvrat (India)
 Raka, Madhu (India)
 Rakic, Zoran (Serbia)
 Rakkiyappan, Rajan (India)
 Ram, V. V. N. S. S. (India)
 Ramachandran, P. T. (India)
 Ramachandran, Ramaseshan (India)
 Ramadas, Ramakrishnan (Italy)
 Ramakrishnan, R. (USA)
 Raman, Parimala (USA)
 Raman, Preeti (India)
 Raman, Srinivasan (India)
 Ramanan, Kavita (USA)
 Ramanan, Sundararaman (India)
 Ramanathan, Padma (India)
 Ramanujam, Ramaswamy (India)
 Ramaré, Olivier (France)
 Ramaswamy, Humcha Nagajois (India)
 Ramaswamy, Jayaram (India)
 Ramaswamy, Mythily (India)
 Ramaswamy, Sundararaja (India)
 Ramavaram, Harish Rao (India)
 Ramazanov, Murat (Kazakhstan)
 Ramdorai, Sujatha (India)
 Ramesh, P. (India)
 Ramesh, G. (India)
 Ramesh, Shankar (India)
 Ramon, Gomez Martin Jose (Spain)
 Ramos, Ana Primo (Spain)
 Ramos, Yboon Victoria García (Peru)
 Ramu (India)
 Ramupillai, Sudhesh (India)
 Rana, Puneet (India)
 Ranade, Nissim (India)
 Rane, Vivek Vishawanath (India)
 Ranga, Alagacone Sri (Brazil)
 Rangarajan, Govindan (India)
 Rangasamy, Parthasarathi (India)
 Rangaswamy, Manikandan (India)
 Rani, Hari Ponnamma (India)
 Rani, Rekha (India)
 Ranjan, Himanshu (India)
 Ransingh, Biswajit (India)
 Rao, Akkavajjula Venkata (India)
 Rao, Arni S. R. Srinivasa (India)
 Rao, B. L. S. Prakasa (India)
 Rao, Bhamidi Visweswara (India)
 Rao, Geetha Srinivasa (India)
 Rao, J. Narasimha (India)
 Rao, K. V. V. Seshagiri (India)
 Rao, K. Venkat (India)
 Rao, Killampalli Srinivasa (India)
 Rao, Pentyala Srinivasa (India)
 Rao, Ravi (India)
 Rao, Sharath Babu Kanday (India)
 Rao, Siddani Bhaskara (India)
 Rao, Srinivasa (India)
 Rao, Taduri S. S. R. K. (India)
 Rappoport, Yury (Russian Federation)
 Rasila, Antti Hermann (Finland)
 Rassias, Michail Themistocles (Greece)
 Rastogi, Priyanka (India)
 Rath, Purusottam (India)
 Rathod, Abhishek Jayanttilal (India)
 Ratnakumar, P. K. (India)
 Raval, Alpan Piyush (India)
 Raveendran, Binoy (India)
 Ravi, Sreenivasan (India)
 Ravi Prasad, V. V. (India)
 Ravinder, B. (India)
 Ravishankar, Krishnamurthi (USA)
 Rawat, Anup Singh (India)
 Rawat, Rama (India)
 Rawla, Mandeep Singh (India)
 Ray, Kalyan (India)
 Ray, Rajendra Kumar (France)
 Ray, Sajal Kumar (India)
 Ray, Swagato Kumar (India)
 Razani, Abdolrahman (Iran)
 Razet, Benoit (India)
 Reddy, K. Satish (India)

- Reddy, Ajay (India)
Reddy, B. Surendrnath (India)
Reddy, G. Janardhana (India)
Reddy, G. L. (India)
Reddy, I. Vinod (India)
Reddy, J. V. Ramana (India)
Reddy, N. Akhileshwar (India)
Reddy, Nandanoor Bhaskar (India)
Reddy, Rami (India)
Reddy, Siva (India)
Rees, Susan Mary (U.K.)
Rehman, Nadeem Ur (India)
Reichert, Nicholas William (USA)
Reichstein, Zinovy Boris (Canada)
Reiten, Idun (Norway)
Rentsen, Enkhbat (Mongolia)
Reshetikhin, Nicolai (USA)
Revi, Arun Koottungal (India)
Reyes, Juan Carlos De Los (Ecuador)
Reynov, Oleg (Russian Federation)
Rezaei, Zeinab (Iran)
Rezaie, Behruz Tayfeh (Iran)
Rhee, Hyangjoo (Rep. Korea)
Richert, Norman John (USA)
Richter, Birgit (Germany)
Ridenour, Timothy Blake (USA)
Riemenschneider, Sherman (USA)
Riesland, Mark Daniel (Germany)
Riordan, Oliver Maxim (U.K.)
Roberts, Justin Deritter (USA)
Rocca, Matteo (Italy)
Roczen, Marko Peter Udo (Germany)
Rodrigues, Jose Francisco (Portugal)
Rohen, Yumnam (India)
Roitman, Moshe (Israel)
Roman, (Russia)
Romerio, Giovanni (France)
Romero, Wilfredo Oscar Urbina (USA)
Roney-Dougal, Colva Mary (U.K.)
Ronning, Frode (Norway)
Rosas, Teresita Ramirez (USA)
Rosenthal, Haskell Paul (USA)
Röst, Gergely (Hungary)
Rouhani, Behzad Djafari (USA)
Rousseau, Christiane (Canada)
Rovenski, Vladimir (Israel)
Roy, Bishwambhar (India)
Roy, Debika (India)
Roy, Debraj (India)
Roy, Priti Kumar (India)
Roy, Rahul (India)
Rubin, Boris (USA)
Rubtsov, Konstantin (Russian Federation)
Rudelson, Mark (USA)
Rudraravapu, Mohan V. G. K. (India)
Sabanac, Zenan (Bosnia and Herzegovina)
Sabat, Samrat (India)
Sabu, P. N. (India)
Sadhu, Vivek (India)
Sadirbajevs, Felikss (Latvia)
Sagar, K. Narsimha (India)
Sagar, Kolte (India)
Sagari, A. Ananda (India)
Saha, Abhishek (Switzerland)
Saha, Bibhas Chandra (India)
Saha, Jyoti Prakash (Italy)
Saha, Kishalaya (India)
Saha, Koushik (India)
Saha, Subhamay (India)
Saha, Tapan (India)
Sahai, Vivek (India)
Sahoo, Binod Kumar (India)
Sahoo, Jajati Keshari (India)
Sahoo, Pradyumn Kumar (India)
Sahoo, Prativa (India)
Sahoo, Swadesh Kumar (India)
Sahraoui, Fatiha (Algeria)
Sahu, Rajeev Anand (India)
Sahu, Sanjeev Anand (India)
Saibaba, E. (India)
Saifi, Ali (United Arab Emirates)
Saifullah, Khalid (Pakistan)
Saikia, Helen Kumari (India)
Saini, Rajesh Kumar (India)
Sainudiin, Raazesh (New Zealand)
Saito, Shuji (Japan)
Saito, Takeshi (Japan)
Sajadi, Farkhondeh (India)
Sajid, Memon (India)
Sajid, Mohammad (Saudi Arabia)
Salarian, Mohammadreza (Iran)
Salavati, Nosratollah (Iran)
Salehipourmehr, Saeed (Iran)
Sali, Attila Csaba (Hungary)
Salimath, Chandrasekharayya (India)
Salimo, Gabriel Ismael (Mozambique)
Salmabeevi, Zeenath K. (India)
Salomone, Monica Gonzalez (Spain)
Samal, Robert (Czech Republic)
Samaniego, Borys Alvarez (Ecuador)
Samanta, Amit (India)
Samuel, Preena (India)
Sanabria, Lorena Armas (Mexico)
Sanasam, Sarat Singh (India)
Sanchez, Casimiro Fernandez (Mexico)
Sanchez, Luis Manuel Tovar (Mexico)
Sánchez, Maria Dolores (Spain)
Sánchez, María G. Rodríguez (Mexico)
Sandeep Repaka Subha (India)
Sandhya (India)

- Sane, Sarang (India)
 Sane, Sharad Sadashiv (India)
 Sangeetha, R. (India)
 Sankaran, Abhisekh (India)
 Sankaran, Parameswaran (India)
 Sanki, Bidyut (India)
 Sanmartino, María (Argentina)
 Santhanam, Gopalakrishnan (India)
 Santhosh, P. (India)
 Santos, Raimundo (Brazil)
 Santos, Walter Ricardo Ferrer (Uruguay)
 Sanz-Solé, Marta (Spain)
 Sapkota, Buddhi Prasad (Nepal)
 Sapharishi, G. K. Narayana (India)
 Sardar, Pranab (India)
 Sardar, Sujit Kumar (India)
 Sari, Bunyamin (USA)
 Sarig, Omri Moshe (Israel)
 Sarkar, Avijit (India)
 Sarkar, Debasis (India)
 Sarkar, Nantu (India)
 Sarkar, Pinaki (India)
 Sarkar, Ram Rup (India)
 Sarkar, Rudra Pada (India)
 Sarkar, Santanu (India)
 Sarkar, Soumen (India)
 Sarkar, Swagata (India)
 Sarma, Bipul (India)
 Sarma, I. Ramabhadra (India)
 Sarma, K. V. Surya Narayana (India)
 Sastri, Chelluri (Canada)
 Sastry, N. S. Narasimha (India)
 Satish, Sharma Vivek (India)
 Sattanathan, M. (India)
 Satyanarayana, Chirala (India)
 Satyanarayana, Latha (India)
 Savitt, David Lawrence (USA)
 Sawae, Ryuichi (Japan)
 Sawant, Anand (India)
 Sawon, Justin (USA)
 Saxena, Ashutosh (India)
 Saxena, Subhash Chandra (USA)
 Schappacher, Norbert (France)
 Schaps, Mary (Israel)
 Schleicher, Dierk Sebastian (Germany)
 Schmitt, Moritz Wilhelm (Germany)
 Schoen, Richad Melvin (USA)
 Schreiber, Bertram (USA)
 Schreyer, Frank-Olaf (Germany)
 Schuette, Christof (Germany)
 Scott, Jeanne (India)
 Seal, Gouri Shankar (India)
 Sebastain, Ronnie Mani (India)
 Sebastian, Elizabeth (India)
 Sebastian, Nicy (India)
 Seck, Cho Hong (South Korea)
 Segal, Edward Paul (U.K.)
 Segida, Ingir (Russian Federation)
 Sehatkhah, Mehdi (Iran)
 Seitz, Georg (Austria)
 Selivanova, Svetlana (Russian Federation)
 Selmi, Ridha (Tunisia)
 Selvaraj, Chellaian (India)
 Selvaraj, Chelliah (India)
 Semenov, Vladimir (Russian Federation)
 Semmler, Klaus-Dieter B. (Switzerland)
 Šemrl, Peter (Slovenia)
 Sen, Ajoy (India)
 Sen, Banti (India)
 Sen, Debasis (India)
 Sen, Mridul Kanti (India)
 Sen, Ritu (India)
 Sen, Sarmistha (India)
 Sen, Shuvam (India)
 Sen, Suparna (India)
 Senapathi, Eswara Rao (India)
 Sengupta, Indranath (India)
 Sengupta, Jyotirmoy (India)
 Senthil Nayaki, V. P. M. (India)
 Seo, Hyeonah (Rep. Korea)
 Seok, Jinmyoung (Rep. Korea)
 Seregin, Grigory (U.K.)
 Sergeichuk, Volodymyr (Ukraine)
 Sergey, Zhuravlev (Russian Federation)
 Serra, Oriol (Spain)
 Seshadri, C. S. (India)
 Seshadri, Harish (India)
 Seshadri, Rajeswari (India)
 Seth, Gauri Shanker (India)
 Sethuraman, Bharath (USA)
 Setra, Prabhaiah Vaddina (India)
 Shackleton, Kenneth (Japan)
 Shah, Aftab Hussain (India)
 Shah, Devbhadra (India)
 Shah, Hemangi Madhusudan (India)
 Shah, Meetal Mahesh (India)
 Shah, Nimish Arun (USA)
 Shah, Riddhi (India)
 Shahmorad, Sedaghat (Iran)
 Shaikh, Absos Ali (India)
 Shaker (India)
 Shakiban, Chehrzad (USA)
 Shamarova, Evelina (Portugal)
 Shankar, Arul (India)
 Shankar, Desale Bhausahab (India)
 Shankar, Nirmala (India)
 Shankhadhar, Karam Deo (India)
 Shanmugam, Balakrishnan (India)
 Shao, Qiman (Hong Kong)
 Shao, Zhiqiang (China)
 Shapiro, Alexander (USA)

- Sharadu, P. (India)
 Sharan, Shambhu (India)
 Sharma, Aastha (India)
 Sharma, Anupam (India)
 Sharma, Anuradha (India)
 Sharma, Bhargava Ram (India)
 Sharma, Bibhya Nand (Fiji)
 Sharma, Jagan Nath (India)
 Sharma, Janak Raj (India)
 Sharma, Kuldeep (India)
 Sharma, Mayank (India)
 Sharma, Mohan D. (India)
 Sharma, Mukesh Kumar (India)
 Sharma, Neha (India)
 Sharma, Pawan (India)
 Sharma, Poonam (India)
 Sharma, Puneet (India)
 Sharma, Pushkar Raj (India)
 Sharma, R. K. (India)
 Sharma, Rajesh Kumar (India)
 Sharma, Ram Parkash (India)
 Sharma, Ram Prakash (India)
 Sharma, Sachin Subhash (India)
 Sharma, Som Datt (India)
 Sharma, Uday Bhaskar (India)
 Sharma, Vikram (India)
 Shastri, Anant Ramachandra (India)
 Shastri, Parvati Anant (India)
 Shastry, Sreekar Malladi (India)
 Shaveisi, Farzad (Iran)
 Shcherbakov, Evgeny (Russian Federation)
 Shchukin, Mikhail (Belarus)
 Sheffield, Scott Roger (USA)
 Sheikh, Neyaz (India)
 Shekhar, Sudhanshu (India)
 Shen, Zifei (China)
 Shen, Zuowei (Singapore)
 Shepelsky, Dmytro (Ukraine)
 Sheshadri, Ch. (India)
 Sheth, Dilip Narayandas (India)
 Shettar, Bharati Mallikarjunappa (India)
 Shetty, Balkrishna (Sweden)
 Shibano, Hiroki (Japan)
 Shikare, Maruti Mukinda (India)
 Shikha, Deep (India)
 Shimomura, Katsunori (Japan)
 Shin, Dongsoo (Rep. Korea)
 Shinoj, T. K. (India)
 Shirali, Shailesh (India)
 Shirkol, Shailaja Shankar (India)
 Shirolkar, Devendra (India)
 Shishikura, Mitsuhiro (Japan)
 Shit, Gopal Chandra (India)
 Shivakumar (India)
 Shivakumar, N. (India)
 Shivarajkumar (India)
 Shivarudrappa, H. L. (India)
 Shkredov, Ilya (Russian Federation)
 Shlyakhtenko, Dimitri (USA)
 Shlyk, Vladimir (Belarus)
 Shnirelman, Alexander (Canada)
 Shoba, V. (India)
 Shobhalatha, Gorram (India)
 Shramov, Konstantin (Russian Federation)
 Shrivastava, Manjulata (India)
 Shrivastava, Saurabh Kumar (India)
 Shroff, Ravi (USA)
 Shroff, Rupal C. (India)
 Shujat, Faiza (India)
 Shukla, Abhishek (India)
 Shukla, Niraj Kumar (India)
 Shukla, Ravindra Prasad (India)
 Shyshkanova, Ganna (Ukraine)
 Siciliano, Gaetano (Brazil)
 Siddabasappa (India)
 Siddiqi, Abul Hasan (India)
 Siddiqui, Shah Alam (India)
 Sidharth, Burra (India)
 Sidoravicius, Vladas (Brazil)
 Sidorova, Nadia (U.K.)
 Siedentop, Heinz Karl H. (Germany)
 Sierra, Cesar Augusto Gomez (Colombia)
 Sigamani, Valarmathi (India)
 Sikander, Fahad (India)
 Silswal, Gyan Prakash (India)
 Silva, Jaime (Portugal)
 Silva, Marcelo (Brazil)
 Silva, Pablo Braz E. (Brazil)
 Sim, Gueseok (Rep. Korea)
 Simha, Roddam Raya (India)
 Simic, Slavko (Serbia)
 Singh, Abhishek (India)
 Singh, Abhishek Kumar (India)
 Singh, Ajit Iqbal (India)
 Singh, Alok (India)
 Singh, Amit (India)
 Singh, Anand Prakash (India)
 Singh, Anupam Kumar (India)
 Singh, Anuraj (India)
 Singh, Ashok Kumar (India)
 Singh, Atul Kumar (India)
 Singh, Baljeet (India)
 Singh, Balwant (India)
 Singh, Dinesh (India)
 Singh, G. Suresh (India)
 Singh, Gagandeep (India)
 Singh, Gurminder (India)
 Singh, Gursharn Jit (India)
 Singh, Harendra Pal (India)
 Singh, Hemant (India)

- Singh, Huidrom Boynao (India)
 Singh, Jagjit (India)
 Singh, Jitender (India)
 Singh, Jitendra Kumar (India)
 Singh, Jyoti (India)
 Singh, Kangujam Priyokumar (India)
 Singh, Karam Ratan (India)
 Singh, Karunesh Kumar (India)
 Singh, Laisom Sharmeswar (India)
 Singh, Mahender (India)
 Singh, Maibam Ranjit (India)
 Singh, Manoj Kumar (India)
 Singh, Mansa C. (Canada)
 Singh, Mayanglambam C. (India)
 Singh, Mohit (India)
 Singh, Moirangthem Premjit (India)
 Singh, Pavinder (India)
 Singh, Preetinder (India)
 Singh, Raj Kishor (India)
 Singh, Rajneesh Kumar (Germany)
 Singh, Ravi Kumar (India)
 Singh, Ravinder (India)
 Singh, Sanasam (India)
 Singh, Sandip (India)
 Singh, Sanjay Kumar (India)
 Singh, Sanjeet (India)
 Singh, Sarva Jit (India)
 Singh, Satya Bir (India)
 Singh, Saumya (India)
 Singh, Seema (India)
 Singh, Sheo Kumar (India)
 Singh, Shyam Lal (India)
 Singh, Simon (U.K.)
 Singh, Sukhdev (India)
 Singh, Tej Bahadur (India)
 Singh, Vinay (India)
 Singh, Yengkhom Satyendra (India)
 Singh, Yumnam Mahendra (India)
 Singhal, Lovy (India)
 Singhi, Navin (India)
 Sinha, Deba Prasad (India)
 Sinha, Deepa (India)
 Sinha, Gauran (India)
 Sinha, Kalyan B. (India)
 Sinha, Prasanta (India)
 Sinha, Rajen (India)
 Sinharoy, Srimanta (India)
 Sitaram, Alladi (India)
 Sivakumar, T. (India)
 Sivaramakrishnan, Arun (India)
 Sivaraman, Ramaswamy (India)
 Sivaraman, Vaidyannathan (India)
 Skopenkov, Mikhail (Russian Federation)
 Skopina, Maria (Russian Federation)
 Skovmose, Ole (Denmark)
 Slominska, Jolanta Wiktoria (Poland)
 Smaranda, Mihaela Loredana (Romania)
 Smarda, Zdenek (Czech Republic)
 Smillie, John David (USA)
 Smillie, Peter Hudson (USA)
 Smirnov, Stanislav (Switzerland)
 Smirnova-Nagnibeda, Tatiana (Switzerland)
 Sobral, Yuri Dumaresq (Brazil)
 Sodin, Mikhail (Israel)
 Sofi, Mohammad Amin (India)
 Sohani, Vijay Kumar (India)
 Solarin, Adewale Roland Tunde (Nigeria)
 Soman, Abhay Anant (India)
 Somashekara, Dhanagodthi D. (India)
 Somasundaram, S. (India)
 Son, Eunyong (Rep. Korea)
 Son, Ju Rak (Rep. Korea)
 Son, Nguyen Khoa (Vietnam)
 Sorrentino, Alfonso (U.K.)
 Sotiropoulos, Megaklis Theodor (Greece)
 Soundararajan, Kannan (USA)
 Sourabh, Sumit (India)
 Soydan, Gökhan (Turkey)
 Sparling, George Arthur James (USA)
 Spielman, Daniel Alan (USA)
 Spinadel, Vera Martha (Argentina)
 Spohn, Karl Herbert (Germany)
 Sprekels, Jürgen (Germany)
 Sridharan, Muthusamy (India)
 Sridharan, Narasimhan (India)
 Srikant, V. (India)
 Srikanth, Pannapalli N. (India)
 Srikanth, Ravulapalli (India)
 Srinathan, Kannan (India)
 Srinivas, Behara (India)
 Srinivas, Kotyada (India)
 Srinivas, Mantripragada A. S. (India)
 Srinivas, Vasudevan (India)
 Srinivasan, K. (India)
 Srinivasan, Annadurai (India)
 Srinivasan, Bhama (USA)
 Srinivasan, Natesan (India)
 Srinivasu Pichika, D. N. (India)
 Sriraj, M. A. (India)
 Srivalli, A. (India)
 Srivastava, Akanksha (India)
 Srivastava, Mohit Kumar (India)
 Srivastava, Nikhil (USA)
 Srivastava, Prachi (India)
 Srivastava, Prashant Kumar (India)
 Srivastava, Rajesh (India)
 Srivastava, Shailesh (India)
 Srivastava, Shashi Mohan (India)
 Srivastava, Shilpee (India)
 Stamatopoulos, Spyros (Greece)
 Starchenko, Sergei (USA)

- Steinbring, Heinz (Germany)
Stempien, Zdzislaw Andrzej (Poland)
Stern, Ronald John (USA)
Stipsicz, Andras Istvan (Hungary)
Stoll, Manfred (USA)
Stollmann, Peter Robert M. (Germany)
Strickland, Elisabetta (Italy)
Stroppel, Catharina Helene (Germany)
Stroth, Gernot (Germany)
Suárez-Serrato, Pablo (Mexico)
Subba Rao, Y. V. (India)
Subbiah, Suriya Prabha (India)
Subhash, B. (India)
Subrahmanyam, P. (India)
Subramania Pillai, I. (India)
Subramanian, C. R. (India)
Subramanian, Easwar (India)
Subramanian (India)
Subramaniyam, Venkat (India)
Sudakov, Benjamin (USA)
Sudhakar, Madiri (India)
Sugiyama, Toshi (Japan)
Suh, Dong Youp (Rep. Korea)
Sukla, Indu Lata (India)
Sultana, Talat (India)
Sulu, Ch. Srinivas (India)
Sumesh, K. (India)
Sun, Wenyu (China)
Sundaravaradhan, Rajan (India)
Sunday, Adegbe Kolawole (Nigeria)
Sunder, Viakalathur (India)
Sunjay (India)
Sunny, Linia Anie (India)
Sur, Arnab (India)
Suragan, Durvudkhan (Kazakhstan)
Surapholchai, Chotiros (Thailand)
Suresh (India)
Suresh, Venapally (India)
Surisetty, Santosh (India)
Survase, Pradnya (India)
Surwade, Kamalakar (India)
Sury, Balasubramanian (India)
Suthar, Om P. (India)
Suvarna, Kalathuru (India)
Suvarna, Nagathinkal T. (India)
Svrtan, Dragutin (Croatia)
Swamy, Dileep L. Narayana (India)
Sy, Polly Wee (Philippines)
Sznitman, Alain-Sol (Switzerland)
- Tabassum, Sabiha (India)
Tade, Subhash (India)
Tadumadze, Tamaz (Georgia)
Taherabadi, Mohd Reza Molaei (Iran)
Tak, Shyam Sunder (India)
Takemura, Tomoko (Japan)
- Takker, Shikha (India)
Taliwal, Vikas (USA)
Talla, Hymavathi (India)
Talponen, Jarno Olavi (Finland)
Tamilselvi, A. (India)
Tamizhmani, K. M. (India)
Tamizhmani, Thamizharasi (India)
Tanaka, Shohei (Japan)
Tanase, Raluca Elena (Romania)
Tandon, Rajat (India)
Taneja, Harish Chander (India)
Taneja, Padmavati (India)
Tang, Tai Man (China)
Tanti, Jagmohan (India)
Tanveer, Mohd (India)
Taubes, Clifford Henry (USA)
Temirgaliyev, Nurlan (Kazakhstan)
Tena, Juan (Spain)
Terdalkar, Hrishikesh Rajesh (India)
Terzic, Svjetlana (Montenegro)
Teschke, Olaf (Germany)
Tetenov, Andrei (Russian Federation)
Tewari, Udai Bhan (India)
Thakar, Sarita (India)
Thakur, Ajay Singh Ramdin (India)
Thakur, Nilesh Kumar (India)
Thakurta, Abhradeep Guha (India)
Thalmi, B. (India)
Thambala, Sharon (India)
Thandapani, Ethiraju (India)
Thang, Dang Hung (Vietnam)
Thangavelu, Geetha (India)
Thao, Pham Van (Vietnam)
Thao, Vo Dang (Vietnam)
The, Hieu Doan (Vietnam)
Thillaisundaram, Anitha (U.K.)
Thomann, Laurent (France)
Thomas, Anne Caroline Mary (U.K.)
Thomas, Edouard (France)
Thomas, Manu Mariam (India)
Thomas, Naiju Malathu (India)
Thomas, Rachel Gai (U.K.)
Thomas, Richard Paul Winsley (U.K.)
Thompson, George (Italy)
Thompson, Robert (USA)
Thorne, Frank Henry (USA)
Thynesh, Valanarasu (India)
Tidke, Haribhau Laxman (India)
Tien, Le Huy (Vietnam)
Tien, Trinh Duy (Vietnam)
Tikhonov, Sergey (Belarus)
Tillmann, Ulrike (U.K.)
Timol, M. G. (India)
Timoney, Richard M. (Ireland)
Tiwari, Awanish (India)
Tiwari, Namita (India)

- Tiwari, Sweta (India)
 Tjhin, Ferry Jaya Permana (Indonesia)
 Toan, Phan Thanh (Rep. Korea)
 Toerner, Guenter (Germany)
 Toland, John Francis (U.K.)
 Tomar, Amit (India)
 Tomar, Anita (India)
 Tondeur, Philippe Maurice (USA)
 Tonks, Andrew (U.K.)
 Tonthat, Tuong (USA)
 Torii, Kotaro (Japan)
 Toro, Tatiana (USA)
 Toure, Saliou (India)
 Touzi, Nizar (France)
 Tran, Minh Binh (France)
 Tranah, David (U.K.)
 Traore, Aboubakari (Ivory Coast)
 Tripathi, Amitabha (India)
 Tripathi, Dharmendra (India)
 Tripathi, Gaurab (India)
 Tripathi, Gyan Prakash (India)
 Tripathi, Lok Pati (India)
 Tripathi, Ram Krishna (India)
 Tripathi, Satya Prakash (India)
 Trivedi, Parthkumar Bhanubhai (India)
 Trivedi, Saurabh (France)
 Troitskiy, Evgeny (Russian Federation)
 Tronel, Gerard Hubert (France)
 Trotman, David (France)
 Trung, Ngo (Vietnam)
 Tsai, Ping-Ying (Taiwan)
 Tsimerman, Jacov (USA)
 Tsuboi, Takashi (Japan)
 Tsukamoto, Ichiro (Japan)
 Tsushima, Ryuji (Japan)
 Tu, Yu-Chao (USA)
 Tumarkin, Pavel (Germany)
 Tungala, Raja Sekhar (India)
 Turaev, Dmitry (U.K.)
 Turunen, Ville Pekka (Finland)
 Tussupov, Jamalbek (Kazakhstan)
 Tyagi, Jagmohan (India)
- Ugarte, Luis (Spain)
 Ulas, Maciej Piotr (Poland)
 Ulecia, Teresa (Spain)
 Ullmo, Emmanuel Bernard (France)
 Upadhyay, Abhitosh (India)
 Upadhyay, Ashish K. (India)
 Upadhyay, Ranjit Kumar (India)
 Upadhyaya, Lalit Mohan (India)
 Uppal, S. M. (Kenya)
 Uppasetty, Madana Swamy (India)
 Uzzell, Andrew James (USA)
- Vaart, A. W. Van Der (Netherlands)
- Vadhan, Salil Pravin (USA)
 Vadlamudi, Venkaiah China (India)
 Vaes, Stefaan (Belgium)
 Vahid, Samireh (U.K.)
 Vaidhyathan, Bharanedhar (India)
 Vaidya, Arunkumar (India)
 Vaidya, S. K. (India)
 Vaish, Vaibhav (India)
 Vajjha, Koundinya (India)
 Vala, Jiri (Ireland)
 Valluri, Maheswara Rao (Oman)
 Vamsi Krishna, D. (India)
 Vani, Kalai (India)
 Vanninathan, Muthusamy (India)
 Varadaraj, Srikar (India)
 Varadhan, Srinivasa (USA)
 Vargas, Edson (Brazil)
 Varghese, Anu (India)
 Varghese, Ginu (India)
 Varma, K. Sidharth (India)
 Varma, Rohith (India)
 Varshney, Rahul (India)
 Varvaruca, Eugen (U.K.)
 Vasanthi, Tatimakula (India)
 Vasanti, Gopal (India)
 Vasudeva (India)
 Vasudeva Murthy, A. S. (India)
 Vedanabhatla, Srinivas (India)
 Velammal, Ganesan (India)
 Velimirovic, Ljubica (Serbia)
 Veloso, Paula Murgel (Brazil)
 Vembu, R. (India)
 Vempati, Raghu Kishore (India)
 Venkatachalam, Selvan (India)
 Venkatalaxmi, Akavaram (India)
 Venkataraman, Geetha (India)
 Venkataraman, Lakshminarayanan (India)
 Venkataramana, Tyakal (India)
 Venkatesh, Akshay (USA)
 Venkatesha (India)
 Venkatram, Kartik Swaminathan (USA)
 Venkatraman, S. K. (India)
 Venketasubramanian, C. G. (India)
 Verma, Abhinav (India)
 Verma, Dayanand (India)
 Verma, Jugal (India)
 Verma, Kaushal (India)
 Verma, Khushboo (India)
 Verma, Mahendra (India)
 Vermeeren, Stijn (U.K.)
 Vershik, Anatoly (Russian Federation)
 Vershinin, Vladimir (France)
 Vershynin, Roman (USA)
 Vesztergombi, Katalin (Hungary)
 Vetcha, Kalyan Srinivas (India)

- Vi, Nhan Nguyen Du (Vietnam)
Viacheslav, Guz (Russia)
Victor, Ganta Jacob (India)
Vidhya, A. (India)
Vidyasagar, M. (USA)
Vielhaber, Michael Johannes (Germany)
Vijay, P. (India)
Vijayakumar, Ambat (India)
Vijayalakshmi, V. (India)
Vijayarajan, A. K. (India)
Villani, Cedric (France)
Vineesh, K. P. (India)
Virk, Rahbar (USA)
Vishnoi, Nisheeth Kumar (India)
Viswanadham, G. Kasi (India)
Viswanath, Sankaran (India)
Vivacqua, Carla Almeida (Brazil)
Vivek (India)
Vodopyanov, Sergey (Russian Federation)
Vogtmann, Karen Lee (USA)
Voisin, Claire (France)
Vu, Dominik (USA)
Vukovic, Mirjana (Bosnia and Herzegovina)
Vyacheslav, Kharitonov (Russian Federation)
Vyas, Rajendra (India)
Vyas, Rishi (U.K.)
Vyas, Vivek Maheshkumar (India)
Vyata, Dhanush Reddy (India)
Vyugin, Ilya (Russian Federation)
- Wada, Shuhei (Japan)
Wadia, Spenta Rustom (India)
Waldschmidt, Michel (France)
Wang, Bin (China)
Wang, Lanyu (China)
Wang, Weiping (China)
Waphare, Balu (India)
Wasadikar, Meenakshi (India)
Watari, Masahiro (Japan)
Wegner, Bernd (Germany)
Wei, Guangsheng (China)
Weinheimer, Heinrich (Germany)
Weismantel, Robert (Switzerland)
Weller, Kerstin Brigitte (Germany)
Welschinger, Jean-Yves (France)
Wen, Bangyan (China)
Wencel, Roman Piotr (Poland)
Wendland, Katrin (Germany)
Wheeler, Mary Fanett (USA)
Wilkinson, Anne Marie (USA)
Wintenberger, Jean-Pierre (France)
Winther, Ragnar (Norway)
Wood, Carol Saunders (USA)
- Woodin, William Hugh (USA)
Woung, Jun Kil (Rep. Korea)
Wright, David Lee (USA)
Wu, Bingye (China)
Wu, Fan (China)
Wu, Jian-Hua (China)
Wu, Shuyun (USA)
Wu, Ziqian (China)
Wulfsohn, Aubrey (U.K.)
Wyk, Leon Van (South Africa)
- Xia, Zhong Yong (China)
Xiang, Shuhuang (China)
Xu, Fengmin (China)
Xu, Jinchao (USA)
Xu, Leshun (China)
Xu, Xiangjin (USA)
Xu, Zongben (China)
- Yadav, Anupam (India)
Yadav, Gyan Chandra Singh (India)
Yadav, Manoj Kumar (India)
Yadav, Neha (India)
Yadav, Pooja (India)
Yadav, Raj Bhawan (India)
Yadav, Rajendra K. (India)
Yadav, Sangita (India)
Yamagishi, Manabu (Japan)
Yamaguchi, Takao (Japan)
Yamini, N. (India)
Yanchevskii, Vyacheslav (Belarus)
Yang, Sung Jin (Rep. Korea)
Yang, Xiaoping (China)
Yashchenko, Ivan (Russian Federation)
Yau, Horng-Tzer (USA)
Yen, Nguyen Dong (Vietnam)
Yengui, Ihsen (Tunisia)
Yie, Ikkwon (Rep. Korea)
Yoo, Hanjong (Rep. Korea)
Yoo, Kijo (Rep. Korea)
Young, Gregg Ronald De (Egypt)
Youvaraj, Gummidigampatti P. (India)
Yu, Hyonju (Rep. Korea)
Yu, Yue (China)
Yun, Ki-Heon (Rep. Korea)
Yunusi, Mahmadyusuf (Tajikistan)
- Zakrzewski, Michal (Poland)
Zamani, Naser (Iran)
Zandee, Alexander (Netherlands)
Zarnescu, Arghir Dani (U.K.)
Zavidovique, Maxime Nicolas (France)
Zelenyuk, Yuliya (South Africa)
Zhang, Chensong (USA)
Zhang, Jieyu (China)
Zhang, Lunchuan (China)

Zhang, Shaohua (China)
Zhang, Xu (China)
Zhao, Bin (China)
Zhao, Peibiao (China)
Zhao, Tianfu (China)
Zhao, Yigeng (China)
Zheng, Liming (China)
Zhou, Haigang (China)
Zhou, Min (China)

Zhou, Xunyu (U.K.)
Zhu, Chengbo (Singapore)
Zhu, Minxian (USA)
Zhu, Yuanguo (China)
Ziegler, Günter Matthias (Germany)
Ziegler, Martin Karl Paul (Germany)
Zoghmane, Mebkhout (France)
Zou, Yun Zhi (China)

Participants by Country

Country	No.	Country	No	Country	No.			
Algeria	...	2	Indonesia	...	6	Romania	...	5
Argentina	...	9	Iran	...	41	Russia	...	56
Armenia	...	1	Ireland	...	6	Saudi Arabia	...	4
Australia	...	15	Israel	...	17	Serbia	...	7
Austria	...	6	Italy	...	17	Singapore	...	7
Bangladesh	...	2	Ivory Coast	...	2	Slovenia	...	2
Belarus	...	6	Japan	...	59	South Africa	...	13
Belgium	...	8	Kazakhstan	...	8	Spain	...	66
Benin	...	1	Kenya	...	5	Sri Lanka	...	1
Bosnia & Herzegovina	...	7	Korea Republic	...	130	Sudan	...	1
Brazil	...	38	Kuwait	...	1	Sweden	...	13
Bulgaria	...	1	Latvia	...	2	Switzerland	...	20
Burkina Faso	...	2	Lesotho	...	1	Taiwan	...	9
Cameroon	...	1	Lithuania	...	1	Tajikistan	...	2
Canada	...	24	Luxembourg	...	1	Tanzania	...	1
Chile	...	6	Madagascar	...	1	Thailand	...	3
Colombia	...	10	Malaysia	...	4	Tunisia	...	4
Croatia	...	3	Mexico	...	25	Turkey	...	8
Czech Republic	...	5	Moldova	...	1	Uganda	...	1
Denmark	...	7	Mongolia	...	2	Ukraine	...	4
Ecuador	...	2	Montenegro	...	1	United Arab Emirates	...	2
Egypt	...	6	Morocco	...	1	United Kingdom	...	72
Estonia	...	1	Mozambique	...	4	USA	...	287
Ethiopia	...	1	Nepal	...	5	Uruguay	...	4
Fiji	...	1	Netherlands	...	8	Uzbekistan	...	2
Finland	...	17	New Zealand	...	9	Venezuela	...	5
France	...	84	Nigeria	...	16	Vietnam	...	26
Georgia	...	4	Norway	...	10			
Germany	...	69	Oman	...	2			
Ghana	...	3	Pakistan	...	2			
Greece	...	3	P. R. China	...	55			
Guatemala	...	1	Peru	...	2			
Hong Kong	...	1	Philippines	...	8			
Hungary	...	15	Poland	...	21			
India	...	1507	Portugal	...	13			

Author Index*

(Volumes II, III, and IV)

- Adler, Jill, **IV** 3213
Anantharaman, Nalini, **III** 1839
Arnaud, Marie-Claude, **III** 1653
Auroux, Denis, **II** 917
- Baake, Ellen, **IV** 3037
Balmer, Paul, **II** 85
Belkale, Prakash, **II** 405
Benjamini, Itai, **IV** 2177
Benson, David J., **II** 113
Bernard, Patrick, **III** 1680
Billera, Louis J., **IV** 2389
Borodin, Alexei, **IV** 2188
Bose, Arup, **IV** 2203
Breuil, Christophe, **II** 203
Brydges, David, **IV** 2232
Buff, Xavier, **III** 1701
Bürgisser, Peter, **IV** 2609
Burq, Nicolas, **III** 1862
- Chen, Shuxing, **III** 1884
Cheng, Chong-Qing, **III** 1714
Chéritat, Arnaud, **III** 1701
Cockburn, Bernardo, **IV** 2749
Cohn, Henry, **IV** 2416
Contreras, Gonzalo, **III** 1729
Costello, Kevin, **II** 942
Csörnyei, Marianna, **III** 1379
- Dancer, E. N., **III** 1901
De Lellis, Camillo, **III** 1910
del Pino, Manuel, **III** 1934
Delbaen, Freddy, **IV** 3054
den Hollander, Frank, **IV** 2258
- Dencker, Nils, **III** 1958
Dwork, Cynthia, **IV** 2634
- Einsiedler, Manfred, **III** 1740
Erschler, Anna, **II** 681
Eskin, Alex, **III** 1185
Evans, Steven N., **IV** 2275
- Fernández, Isabel, **II** 830
Fomin, Sergey, **II** 125
Frankowska, Hélène, **IV** 2915
Fu, Jixiang, **II** 705
Fusco, Nicola, **III** 1985
- Gabai, David, **II** 960
Gaboriau, Damien, **III** 1501
Goldman, William M., **II** 717
Gordon, Iain G., **III** 1209
Greenberg, Ralph, **II** 231
Grodal, Jesper, **II** 973
Guruswami, Venkatesan, **IV** 2648
Guth, Larry, **II** 745
- Hacon, Christopher D., **II** 427, 513
Hamenstädt, Ursula, **II** 1002
Heath-Brown, D.R., **II** 249
Hertz, Federico Rodriguez, **III** 1760
Hutchings, Michael, **II** 1022
Huybrechts, Daniel, **II** 450
- Its, Alexander R., **III** 1395
Ivanov, Sergei, **II** 769
Iwata, Satoru, **IV** 2943
Izumi, Masaki, **III** 1528

*Names of invited speakers only are shown in the Index.

- Kaledin, D., **II** 461
Kapustin, Anton, **III** 2021
Karpenko, Nikita A., **II** 146
Kedlaya, Kiran Sridhara, **II** 258
Khare, Chandrashekhar, **II** 280
Khot, Subhash, **IV** 2676
Kisin, Mark, **II** 294
Kjeldsen, Tinne Hoff, **IV** 3233
Koskela, Pekka, **III** 1411
Kuijlaars, Arno B.J., **III** 1417
Kumar, Shrawan, **III** 1226
Kunisch, Karl, **IV** 3061
Kupiainen, Antti, **III** 2044
- Lackenby, Marc, **II** 1042
Lando, Sergei K., **IV** 2444
Lapid, Erez M., **III** 1262
Leclerc, Bernard, **IV** 2471
Liu, Chiu-Chu Melissa, **II** 497
Losev, Ivan, **III** 1281
Lück, Wolfgang, **II** 1071
Lurie, Jacob, **II** 1099
- Ma, Xiaonan, **II** 785
Maini, Philip K., **IV** 3091
Marcolli, Matilde, **III** 2057
Markowich, Peter A., **IV** 2776
Marques, Fernando Codá, **II** 811
Martin, Gaven J., **III** 1433
Mastropietro, Vieri, **III** 2078
McKay, Brendan D., **IV** 2489
McKernan, James, **II** 427, 513
Mira, Pablo, **II** 830
Mirzakhani, Maryam, **II** 1126
Moore, Justin Tatch, **II** 3
Morel, Sophie, **II** 312
- Nabutovsky, Alexander, **II** 862
Nadirashvili, Nikolai, **III** 2001
Naor, Assaf, **III** 1549
Nazarov, Fedor, **III** 1450
Nešetřil, J., **IV** 2502
Nesterov, Yurii, **IV** 2964
Neuhauser, Claudia, **IV** 2297
Nies, André, **II** 30
- Nochetto, Ricardo H., **IV**, 2805
- Oh, Hee, **III** 1308
- Pacard, Frank, **II** 882
Park, Jongil, **II** 1146
Păun, Mihai, **II** 540
Peterzil, Ya'acov, **II** 58
- Quastel, Jeremy, **IV** 2310
- Rains, Eric M., **IV** 2530
Reichstein, Zinovy, **II** 162
Riordan, Oliver, **IV** 2555
Rudelson, Mark, **III** 1576
- Saito, Shuji, **II** 558
Saito, Takeshi, **II** 335
Sarig, Omri M., **III** 1777
Schappacher, Norbert, **IV** 3258
Schreyer, Frank-Olaf, **II** 586
Schütte, Christof, **IV** 3105
Seregin, Gregory A., **III** 2105
Shah, Nimish A., **III** 1332
Shao, Qi-Man, **IV** 2325
Shapiro, Alexander, **IV** 2979
Shen, Zuowei, **IV** 2834
Shlyakhtenko, Dimitri, **III** 1603
Sodin, Mikhail, **III** 1450
Soundararajan, K., **II** 357
Spielman, Daniel A., **IV** 2698
Spohn, Herbert, **III** 2128
Srinivas, Vasudevan, **II** 603
Starchenko, Sergei, **II** 58
Stipsicz, András I., **II** 1159
Stroppel, Catharina, **III** 1344
Sudakov, Benny, **IV** 2579
Suresh, V., **II** 189
- Thomas, Richard P., **II** 624
Toro, Tatiana, **III** 1485
Touzi, Nizar, **IV** 3132
Turaev, Dmitry, **III** 1804
- Vadhan, Salil, **IV** 2723
Vaes, Stefaan, **III** 1624

-
- van de Geer, Sara, **IV** 2351
van der Vaart, Aad, **IV** 2370
Venkataramana, T. N., **III** 1366
Venkatesh, Akshay, **II** 383
Vershynin, Roman, **III** 1576
- Weismantel, Robert, **IV** 2996
Welschinger, Jean-Yves, **II** 652
Wendland, Katrin, **III** 2144
Wheeler, Mary F., **IV** 2864
- Wilkinson, Amie, **III** 1816
Wintenberger, Jean-Pierre, **II** 280
- Xu, Jinchao, **IV** 2886
Xu, Zongben, **IV** 3151
- Yamaguchi, Takao, **II** 899
- Zhang, Xu, **IV** 3008
Zhou, Xun Yu, **IV** 3185

Author Index*

(Volume I)

Aldous, David J., 141	Lindenstrauss, Elon, 531
Arthur, James, 57	Parimala, R., 339
Avila, Artur, 154	Parshin, A. N., 362
Balasubramanian, R., 176	Peng, Shige, 393
Ball, J. M., 739	Plofker, Kim, 433
Bosch, Carlos, 662	Ramanujam, R., 668
Châu, Ngô Bao, 210	Reiten, Idun, 558
Coron, Jean-Michel, 238	Rousseau, Christiane, 723
Daubechies, Ingrid, 115	Schoen, Richard, 449
Dinur, Irit, 265	Skovsmose, Ole, 690
Furstenberg, Harry, 51, 286	Smirnov, Stanislav, 595
Gowers, W. T., 657	Steinbring, Heinz, 680
Huggett, Stephen, 757	Varadhan, S. R. S., 622
Hughes, Thomas J. R., 299	Villani, Cédric, 640
Kalai, Gil, 101	Voisin, Claire, 476
Kenig, Carlos E., 326	Woodin, W. Hugh, 504
Kesten, Harry, 73	Yau, Horng-Tzer, 87
Li, YanYan, 127	Ziegler, Günter M., 706

*Names of invited speakers only are shown in the Index.